



2017  
2018



Sensors



Vision



Lighting &  
Indicators



Wireless



Machine  
Safety

# Who is Banner

---

Every day, thousands of times a day, in locations all around the world, products from Banner Engineering are used to solve challenging problems and achieve automation goals. We're proud of that fact.

Founded by Bob Fayfield in 1966, Banner Engineering began as a small engineering firm known for solving problems. Customers came to us for smart, well-built products, custom solutions, and personal, attentive service. With each success we increased our technical capabilities and manufacturing capacities, grew in staff and industry expertise, strengthened our relationships with customers and partners, and expanded our reach throughout the United States and the world.



From the very beginning, we have been committed to developing new and innovative solutions, delivering products of the highest quality, fulfilling the needs of each customer, and operating with honesty and integrity. These commitments continue to guide us and define us as a company.

Today Banner Engineering is a global company and a globally recognized leader in the field of process and industrial automation. Our sensors and vision sensors, LED lights and indicators, wireless and safety products are used by companies large and small, from industry leaders in the Fortune 500 to innovators just entering the market. Headquartered in Minneapolis, MN, Banner has sales offices, production facilities, and field representatives throughout North and South America, Asia, Africa, Australia, and Europe. Companies all around the world use our award winning products and solutions to increase efficiency, reduce expenses, ensure quality, monitor and control processes, safeguard equipment and protect personnel.

For five decades our customers have honored us with their business, relying on the quality and performance of our products and solutions, as well as our expertise, our experience and our integrity. We look forward to the decades to come and to many more years of providing our customers with superior service, exceptional products, innovative solutions, and helping them solve problems and achieve their goals.



# Contents

## Sensors page 23

### Photoelectric 30

Featured 30		Rectangle 74		Right Angle 105		Barrel 130			Slot & Area 142		Miniature 152		Fiber Optics 162		
Q4X	34	MINI-BEAM	76	T8	100	M12	116	M18	126	SLM	144	VSM	154	Amps	162
Q3X	38	Q25	78	T18	102	S12-2	118	M18-3	128	SL	146	VS1	156	Plastic	174
QS18	40	Q40	80	TM18	106	SB12	120	M18-4	130	LX	148	VS2	158	Glass	192
QS30	56	Q45	84	T30	110	S18-2	122	S30	138			VS3	160		
Q12	66	Q60	88			S18	124	SM30	140						
Q20	70	PicoDot	92												
		QM42/QMT42	94												

## Vision page 340

Vision Sensors 342		Smart Cameras 348		Vision Controllers 358	
iVu	342	VE	350	PresencePLUS Pro II	358
		PresencePLUS P4	354		

## Lighting & Indicators page 380

LED Lighting 384				Tower Lights 412							
WLS28-2	386	WLS27	396	WL50S	404	TL70	414	TL50C	422	CL50	430
WLS15	390	WLC60	398	WL50-2	406	TL50	418	TL50BL	426		
WLB32	392	WLC90	400								
WLB92	394	WLA	402								

## Wireless page 503

Simple Wire Replacement 504		Wireless Sensors 512	
PM2	505	Q45	512
MP8	506	Q120	514
PB2	508	QM42VT	516
Serial Data Radio	509	K50U	518
Ethernet Data Radio	510	M12F	520

## Machine Safety page 544

Light Screens 552		Safety Controllers 582		Emergency Stop Buttons 598		Emergency Stop and Stop Control 620	
EZ-SCREEN SLS	556	SC26-2	584	Illuminated 30 mm	600	RP-RM83	622
EZ-SCREEN LS	560	XS26-2	588	Illuminated Flush	601	RP-LS42	623
EZ-SCREEN LP	564	SC22-3	592	Panel mount	612	RP-QM72	624
EZ-SCREEN Grid & Points	572			Mechanical	616	RP-LM40	625
EZ-SCREEN Type 2	578					RP-QM90	626
						ED1G	636

## Accessories page 720

Brackets 722		Cordsets 758		Misc Accessories 790		International Reps 826	
--------------	--	--------------	--	----------------------	--	------------------------	--

## Measurement 200

Laser	202	Ultrasonic	216	Radar	240	Array	246	Temp & Vibration	260	Barcode Scanners	270	Registration/Color	282	Stainless Steel	296	Clear Object	310	Hazardous Area	328		
LTF	204	QT50U	218	T18U	230	Q120R	245	EZ-ARRAY	248	M18T	262	iVu BCR	272	QC50	284	QM26	298	QS18	312	MINI-BEAM	330
LE	206	S18U	222	Q45U	232	Q240R	243	MINI-ARRAY	252	M12F	264	P4 BCR	278	Q26	286	QMH26	300	Q4X	314	Q45	336
LH	208	T30UX	224	Q45UR	234	QT50R	244	HR MINI-ARRAY	256	QM42VT	266	TCNM	280	QL56	288	M25U	302	QS30	316	SMI30	338
LG	210	T30U	226	QS18U	237									R58	290	SM30	304	Q26	318		
LT3	212	M25U	226											R55	294	VSM	306	OMNI-BEAM	320		
LT7	214													M18	308	MINI-BEAM	322				

## Special Purpose 268

### Vision Lighting 364

Ring Lights	366	Linear Array Backlights Lights	371	Spot Lights	374
Area Lights	378	Linear Array Lights	372	Low-Angle Ring Lights	376
Backlights	370	On-Axis Lights	373	Laser Line Generator Lights	377

### Base Mount Indicators 436    Barrel/T-Style Indicators 448    Flat Mount Indicators 456    Touch Buttons 468    Pick-to-Light 482

K30L Gen 2	438	K90L	443	S18L	450	K80L	458	SP150	465	K30 Touch	468	K30 Touch	484	K80 PB	492
K50L Gen 2	439	K50LD	445	S22L	451	K80 Call Light	460	SP250	465	K50 Touch	472	K50 Touch	486	VTB	494
K50L Audible	441	K30/K50 Haz	446	T8L	454	K50FL	461	SP350	465	K70 Touch	474	K70 Touch	488	PVD	496
K70L	442	S18L	450			K80FL	462	TL30F	466	K30/K50 Push-Button	476	K50 Optical	490	PVL	498
						K80 Segment	464			OTB/LTB	478	K30 PB	492	PVA	500
										VTB	480	K50 PB	492		

### Network Radios 522    Wireless Controllers 528

DX80 Performance Series	522	DXM100	528
Multihop Modbus	524		
DX99	526		

### Interlock Switches 640    Two-Hand Control 680    Laser Scanner 692    Safety Modules 698

Magnet	642	Two Hand-Control Module	682	AG4	693	E-Stop Guard	699	Safe Speed	714
Hinge	646	STB Buttons	686			Universal	706	Interface Relay	716
Two Piece	654	Run Bar	690			Safety Mat Monitoring	708	Extension Relay	718
Locking	666					Muting	710		

# New Products



## Q4X Series

Versatile, Rugged, Laser Measurement Sensor

- Save time and money with the Q4X Series which is **ready to measure right out of the box**
- A simple user experience from installation to setup
  - Bright spot for easy alignment
  - Three push buttons simplify setup
  - Intuitive menus
- Four-digit display **shows distance to target in mm**
- **FDA-grade stainless steel** is suitable for IP69K washdown environments

See page 34



# LTF Series

## 12 m Range Time-of-Flight Laser Sensor

- A powerful distance measuring sensor with **advanced functions** including:
  - Remote teach
  - High excess gain for seeing really dark targets
  - Laser power control for accurately measuring shiny targets
  - Laser inhibit
  - Cross-talk avoidance
  - Fast response speed
  - Delay timers
- Sensing range of 50 to 12,000 mm
- Durable metal housing **rated IP67**
- Superior resistance to ambient light sources

See page 204





## QS18 Clear Object Detection

### Coaxial Clear Object Detection

- Save time and simplify setup with a pushbutton teach or potentiometer
- 18 mm threads or side mount holes for easy installation
- **Small LED spot size** for tight installations
- Detect from the object to the face of the sensor with **no blind spot**

See page 40

## LE Series

### Laser Measurement Sensor

- Ready to **measure right out of the box**
- Easy alignment with a visible laser
- Multiple teach options simplifies setup for any application
- Convenient setup with a **two-line, eight-character display**

See page 206



# DF-G Series

## Advanced Fiber Optic Amplifiers

- Simple push button Teach
- Rocker switch for manual adjustment
- **Easy-to-read display** shows both the current signal strength and switching threshold
- DF-G1: Expert teach and set methods ensure optimal gain and threshold
- DF-G2: Ideal for short duration events with 10  $\mu$ s response speed
- DF-G3: Ideal for long range sensing, low contrast and precise positioning

See page 162



# Vantage Fibers

## Advanced Fiber Optic Amplifiers

Plastic fibers are typically used for more general purpose applications where they can tolerate extreme bending and be cut to length to fit in limited space setups.

See page 176





## WLS27 Series

---

### Industrial LED Light Bar

- Rugged, water-resistant **IP66, IP67 and IP69K** design
- **Cascade models** for connecting multiple lights end-to-end, minimizing wiring
- Energy efficient for overall cost savings
- Optional snap clips for easy installation and repositioning
- Ability to adjust the lights to Hi/Lo/Off
- **Automatic temperature protection** built into the unit protects the life of the product
- Eight different lengths and dual-color models available

See page 396



# WLB92 Series

## 92 mm Industrial LED Light Bar

- Increase worker productivity and ergonomics with bright, high-quality, uniform light
- Durable light stands up to difficult environments with a **rugged metal housing** and shatterproof light cover
- Energy efficient for overall cost savings
- Easy installation with a variety of mounting brackets: surface, swivel, snap and hanging
- All models include built in dimmable control
- AC models are DLC qualified with a five year warranty
- Six color options available

See page 442



## DXM Series

### Industrial Wireless Controller

- **Control wireless networks**, consolidate networks, create a network backbone
- **Programmable** to solve specific applications
- **Ethernet** and cellular connectivity
- Send alert messages
- Create local logs
- Relay register data to the cloud

See page 528



# QM42 Series

## Wireless Vibration Monitoring

- **Predictive maintenance** made easy by high accuracy vibration (RMS velocity) and temperature measurements
- Easily **monitor machine health** by sending information wirelessly
- **Detect problems earlier** to avoid machine failures and delays
- Manufactured with a robust zinc alloy housing

See page 516



# K50U Series

## Wireless Ultrasonic Monitoring

- Provides a distance measurement from the target to the sensor
- Monitor wirelessly to **avoid long cable runs**
- Built-in temperature compensation for reliable measurement
- Sensing range from 300 mm to 3 m
- Threaded housing for **easy installation**

See page 518





# New Products



## VE Series

Compact, Durable, Versatile Smart Camera

- Two-line, eight-character display and push buttons enable troubleshooting and camera status
  - Perform product change or trigger
  - Change or view IP address, MAC address or speed
  - View firmware, focus number or status
- **Robust, aluminum housing** for harsh environments
- Ethernet connector with **GigE transfer capability**
- C-mount lens to suit a variety of applications
- Optional lens cover provides an IP67-rated solution

See page 350

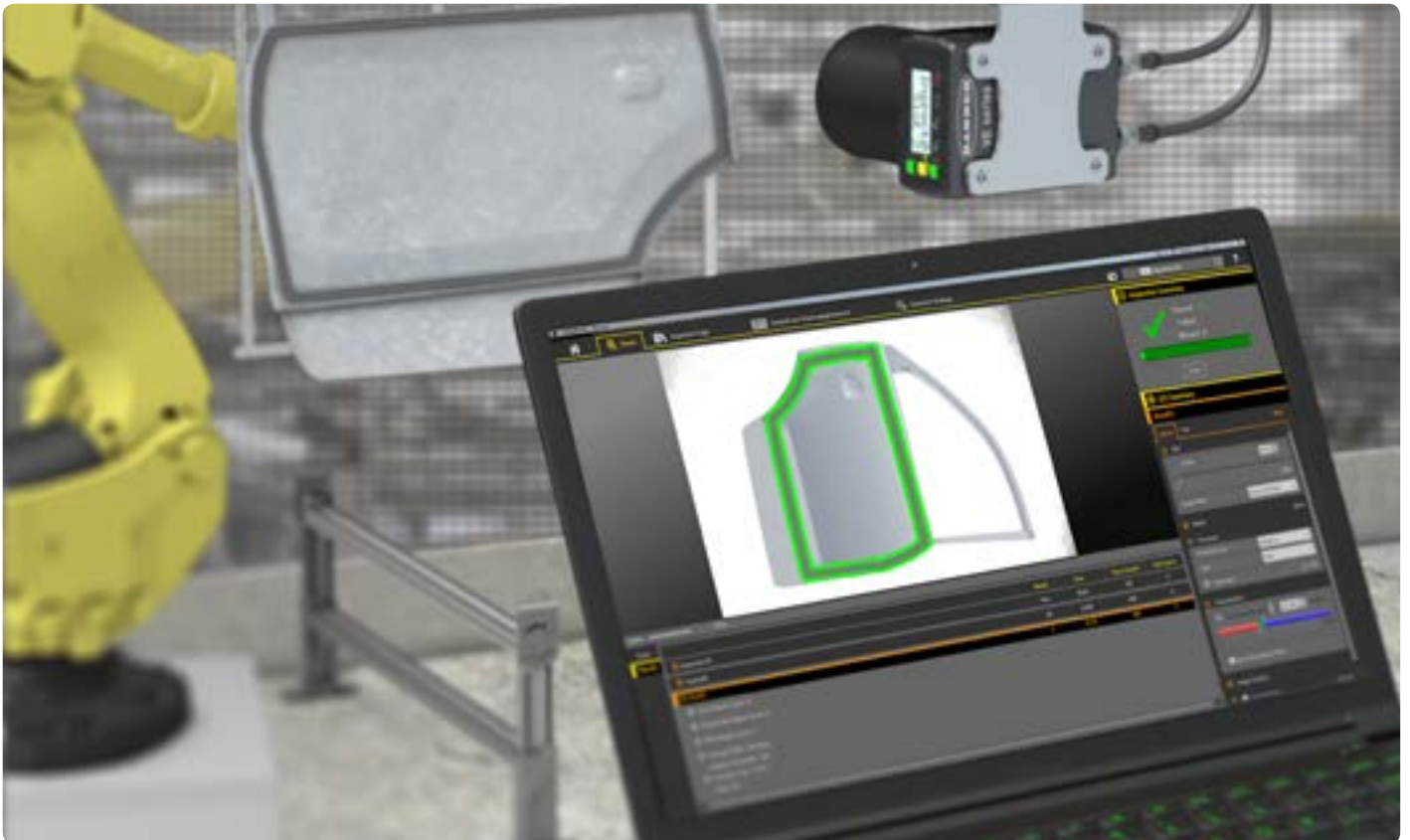

# EZ-SCREEN® LS

## Simple, Rugged Safety Light Curtains

- No blind zone design provides **end-to-end sensing** to eliminate gaps in detection
- A **12 m range** with three available resolutions: 14, 23 and 40 mm
- Standard pairs, cascade systems and extensive accessories to suit a wide variety of safeguarding configurations
- Addition of remote or integrated indication lights on cascade models provides clear communication of system status
- **Alignment indicators** are highly visible and intuitive diagnostics simplify setup, facilitate troubleshooting and streamline installation

See page 560



## XS26-2

### Expandable Safety Controller

- **Up to eight expansion I/O modules** can be added as your automation needs grow or change
- Choose from six expansion modules available to suit your application with a variety of safety inputs, solid-state safety outputs and safety relay outputs
- **Simulation mode and live display** feature allows testing and active monitoring of I/O on a PC
- **Free configuration software**
- Standard communications including EtherNet/IP, Modbus/TCP, and ProfiNet

See page 588



## IO-Link Products

---



Designed to facilitate communication between sensors/actuators from different manufacturers and higher-level systems, the fieldbus-independent IO-Link serial communication protocol offers a uniform standard that applies to all manufacturers.



EZ-ARRAY®  
See page 246



Q4X  
See page 34



QS18 COD  
See page 40

DF-G1  
DF-G2  
DF-G3

See page 162



LTF  
See page 204



TL50  
See page 418

LE  
See page 206



# Applications



## Automotive

---

The manufacturing of vehicles is a very diverse and complex process requiring participation from hundreds of Tier 1 and 2 supplier companies to deliver a finished product to the consumer. A high level of automation is used throughout the automotive supply chain, requiring a broad spectrum of controls to ensure quality, productivity and worker safety on the plant floor.

Whether it is a basic sensor for conveyor lines, safeguarding devices for operator safety or vision-based technology for error proofing, Banner Engineering offers a wide range of solutions to meet the challenges of today's automotive manufacturer.

### Sample applications

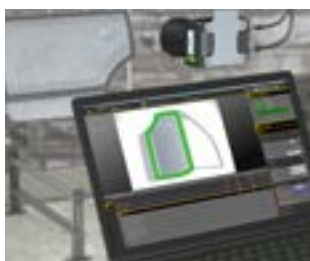

**VE** page 350

A VE Series Smart Camera, configured to use the bead tool, inspects each door panel for the presence and consistency of adhesive.



**EZ-SCREEN® LS** page 560

Banner's EZ-SCREEN® LS cascading Safety Light Curtains simplify the guarding of multiple areas with production equipment.



**Q4X** page 34

The Q4X triangulation-based laser sensor has no difficulty detecting dark targets on dark backgrounds when there is a height difference. The Q4X provides a reliable sensing solution and makes pass/fail judgments based on distance rather than color or reflectivity.



**K50** page 486

Banner provides the broadest selection of Pick-to-Light devices for bin picking applications.



## Food & Beverage

Automated processes in the food and beverage industry have ever increasing needs to address challenging applications and environments, and have a demand for tracking methods to address food contamination before human consumption. To eliminate bacteria and the risk of food borne illness, equipment must be washed down using pressurized water, high temperatures and aggressive chemicals. The components used on this equipment must be designed to stand up to harsh environmental conditions and need to meet hygienic design standards for easy cleaning.

Banner Engineering provides many products for sensing, identification, inspection, communication, safety and wireless transmission that can be applied to food and beverage applications. Banner proudly offers solutions to the industry with a variety of specifications to address customers' environmental concerns, including IP69K/IP67 ratings, ECOLAB® certification, hygienic designs and stainless steel housings.

### Sample applications



**Q4X** page 34

The rugged Q4X photoelectric sensor detects the presence of a clear glass bottle to ensure it is in the correct place before it is filled.



**T18** page 102

The T18 sensor reliably counts trays of ground meat on a conveyor.



**iVu Plus TG** page 342

Banner's iVu Plus TG vision sensor inspects trays to ensure there are six buns per tray.



**DX80** page 504

Banner's DX80 monitors the liquid level in a reservoir of a filling machine with a wireless radio instead of using a slip ring.



# Applications



## Material Handling

Material handling is the process of handling finished goods throughout the entire cycle from finished product all the way through distribution. This includes various types of movement, including intermodal shipping, warehouse operations, conveyance, storage and distribution center operations. Other material handling operations include baggage handling, vehicle control and post-primary packaging operations.

Banner Engineering is well versed on the intricacies of the material handling industry and is synchronized with the industry's objectives of increasing manufacturing efficiencies by reducing downtime and overall manufacturing costs. Banner's vast offering, including sensor, vision, safety and lighting products, suits needs for material handling applications ranging from inception to installation. With a history of high performance, Banner provides quality products with lasting performance.

### Sample applications



**QS18** page 40

Banner's QS18 reliably detects baggage along a conveyor to ensure efficient, optimized baggage handling processes.



**PresensePlus® P4** page 354

Banner's highly reliable P4 Vision Sensor reads barcodes to detect the presence and absence of products at a distribution center.



**TL50** page 412

Banner's E-Stop Button and Signal Tower Lights with audible alarms provide highly visible and audible fault detection. The E-Stop button is setup for use in case of an emergency as a part of safety control.



**DX80** page 503

Banner Engineering's indicators and wireless products help create a safe environment for workers by providing forklift and traffic control in pick-to-light applications.



## Packaging

In the packaging industry, the package can be just as important as the product. As consumers' tastes change so does the packaging to reflect consumer preference. Today's packaging machines must be flexible for quick product changeovers and accommodate new product materials and designs while maintaining fast and efficient throughput.

Banner Engineering understands the needs of today's packagers. Whether it is safeguarding a robotic case packer, reading barcodes for track and trace systems, inspecting label position, counting bottles going into a flow wrapper, monitoring product levels or call for parts, Banner has a solution to fit your needs.

### Sample applications



**QS18** page 40

Banner's QS18LD laser sensor scans across the top of the package to see if any flaps are open.



**R58** page 282

With a 15  $\mu$ s repeatability, Banner's R58 can track the position of each label on the web to ensure the label is correctly positioned on a bottle. One sensor can be used for all label color combinations with three LED sensing colors.

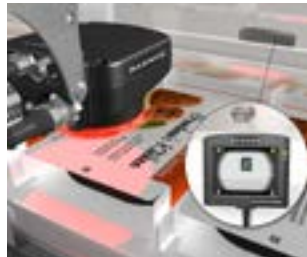

**iVu BCR** page 270

After the frozen dinner is placed in the carton, Banner's iVu BCR reads a 2D code on the carton to ensure it is the correct carton to prevent packaging errors.



**WLS27** page 396

Using high-powered and long-lasting LED technology, Banner's WLS27 work lights are compact and bright enough to use in this area for optimal visibility.



# Applications



## Pharmaceutical

The manufacturing of pharmaceutical and medical products requires a high level of control to maintain product integrity, overall quality and process efficiency. Banner Engineering offers sensing expertise and solutions for a wide range of applications in pharmaceutical and medical industries, providing customers with reliable detection, accurate inspection, advanced sensing technologies and cost-effective solutions.

Banner Engineering can solve the most challenging sensing problems and can rapidly analyze an application to find the optimal solution. Banner has the expertise to provide solutions in many pharmaceutical and medical areas including pharmaceutical solid or liquid dose packaging, pharmacy automation, lab automation, clinical diagnostic automation, product identification, track-and-trace, seal integrity verification, visual indication and process/facility sensing and monitoring.

### Sample applications



**Q12 Fixed-Field** page 66

The compact Q12 fixed-field sensor is ideal for space constraint applications. The fixed-field sensing provides excellent background suppression for reliable sensing even on closely positioned conveyors in automated syringe processing equipment.



**iVu BCR** page 272

The iVu Bar Code Reader (BCR) with a remote touch screen display simplifies barcode reading of various symbologies including 1D, 2D Datamatrix, and PharmaCode. Inspection configuration can be setup easily using the touch screen without the need of a PC.



**WLA** page 402

Banner's WLA Series are LED lights designed for work cell illumination. The WLA lights are ideal as overhead lighting in visual inspection stations for pharmaceutical liquid dose packaging. These lights provide excellent intensity, uniformity and a continuous working-life of over 50,000 hours.



**DX80** page 503

Banner's SureCross® Wireless I/O Network provides an easy way to communicate and monitor I/Os where wiring is not feasible. Temperature and humidity monitoring points can be easily populated throughout a pharmaceutical manufacturing facility using the DX80 wireless network.



## Assembly & Manufacturing

Assembly and manufacturing industries are a vital component of the world's economy. Employee knowledge and innovative, reliable products ensure manufacturing and assembly industries meet productivity goals and quality standards.

Banner Engineering understands the diverse needs in manufacturing and assembly processes, which is why we provide solutions for all types of manufacturing and assembly. Whether manual or automatic processes, Banner offers safety, pick-to-light, LED lighting, sensor and vision products to help with many applications, including quality checks, production line verification, precision, assembly verification and many more with long-lasting solutions.

### Sample applications



**QS30** page 56

Keeping the feeder bowl stocked with parts is necessary to ensure the process continues without interruption.



**VE** page 350

To verify the expected number of holes exists on a small metal part, the VE Smart Camera with Multipoint Inspections can be configured for multiple regions of interest (ROIs) to ensure holes exist and were punched in the correct place.



**Q45 Push Button** page 512

Operators need a way to easily call forklift drivers for additional parts or to remove completed assemblies. Banner's wireless network and K50 indicator lights create a complete parts delivery solution for improved communication between work station operators and forklift drivers.



**30 mm E-Stop** page 635

The E-Stops run along the length of a conveyor so the operator can press it from anywhere along its length to immediately stop the conveyor.



# SENSORS



**BANNER ENGINEERING**  
Q4X Series  
bannerengineering.com

LO/DO  
TEACH 2 sec  
MODE  
SELECT

---





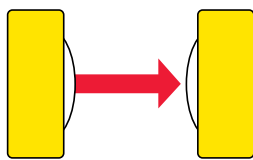









PHOTOELECTRIC	page 30
MEASUREMENT	page 201
SPECIAL PURPOSE	page 268

# SENSOR SELECTION GUIDE



**Opposed Mode**

The sensor's emitter and receiver are housed in two separate units. The emitter is placed opposite the receiver. An object is detected when it breaks the effective beam.

Model	Range	Dims (H x W x D)	IP Rating	Power Supply	Output	Page #
 QS18	20 m	35 x 15 mm (D varies by model)	IP67; NEMA 6P	10-30 V dc 20-140 V ac/dc 20-270 V ac/dc	DC: PNP or NPN P-MOSFET N-MOSFET	40
 QS30	60 m	44 x 22 mm (D varies by model)	IP67; NEMA 6	10-30 V dc 12-250 V ac/dc 24-250 V ac/dc	DC: Bipolar NPN/PNP AC/DC: SPDT e/m relay	56
 Q12	2 m	23 x 8 x 12 mm	IP67	10-30 V dc	Bipolar NPN/PNP, PNP or NPN	66
 Q20	20 m	35 x 15 x 31 mm	IP67; NEMA 6P	10-30 V dc	PNP or NPN	70
 Q45	60 m	88 x 45 x 55 mm	IP67; NEMA 6P	10-30 V dc 90-250 V ac 12-250 V ac/dc 5-15 V dc (NAMUR)	DC: Bipolar NPN/PNP AC: SPST * AC/DC: SPDT Relay NAMUR: Constant current	84
 MINI-BEAM®	30 m	31 x 12 x varies	IP67; NEMA 4X	10-30 V dc 24-240 V ac 5-15 V dc (NAMUR)	DC: Bipolar NPN/PNP AC: SPST NAMUR: Constant current	76
 Q25	20 m	50 x 25 x 30 mm	IP67; NEMA 6P	10-30 V dc 20-250 V ac	DC: PNP or NPN AC: SPST*	78
 Q40	60 m	70 x 40 x 46 mm	IP67; NEMA 6P	10-30 V dc 20-250 V ac	DC: PNP or NPN AC: SPST*	80
 QM42	10 m	42 x 13 x 42 mm	IP67; NEMA 6P	10-30 V dc	PNP or NPN	94
 QMT42	10 m	58 x 18 x 42 mm	IP67; NEMA 6P	10-30 V dc	PNP or NPN	95
 T8	2 m	19 x 19 x 16 mm	IP67; NEMA 6	10-30 V dc	PNP or NPN	100
 T18	20 m	DC: 42 x 30 x 30 mm AC: 52 x 30 x 30 mm	IP67; NEMA 6P, IP69K	10-30 V dc 20-250 V ac	DC: PNP or NPN AC: SPST*	102
 TM18	20 m	41 x 30 x 30 mm	IP67 or IP69K	10-30 V dc	PNP or NPN	106
 T30	60 m	52 x 40 x 45 mm	IP67; NEMA 6P, IP69K	10-30 V dc 20-250 V ac	DC: PNP or NPN AC: SPST*	110

\* AC models are solid-state

Model	Range	Dims (H x W x D)	IP Rating	Power Supply	Output	Page #
 M12	5 m	12 x 67.5 mm	IP67; NEMA 6P	10-30 V dc	PNP or NPN	116
 S12-2	20 m	ø 12 x 34 mm	IP67	10-30 V dc	PNP or NPN	122
 S12	15 m	16 x 31 mm	IP65	10-30 V dc	PNP or NPN	118
 SB12/SB12T	1.5 m	15.8 x 31 mm	IP65	10-30 V dc	PNP or NPN	120
 S18	20 m	DC: ø 18 x 59 mm AC: ø 18 x 85 mm	IP67; NEMA 6P	10-30 V dc 20-250 V ac	DC: PNP or NPN AC: SPST*	124
 M18 M18-3 M18-4	20 m 25 m 25 m	ø 18 x 59 mm ø 18 x 88 mm ø 18 x 88 mm	IP67; NEMA 6P, IP69K	10-30 V dc	PNP or NPN	126
 S30	60 m	DC: ø 30 x 69 mm AC: ø 30 x 81 mm	IP67; NEMA 6P	10-30 V dc 20-250 V ac	DC: PNP or NPN AC: SPST*	140
 SM30	150 m	ø 30 x 99 mm	IP67; NEMA 6P	10-30 V dc 24-240 V ac	Bi-Modal PNP/NPN AC: SPST*	140
 SLM	220 mm	Max size: 12 x 252 x 140 mm	IP67	10-30 V dc	Bipolar NPN/PNP	144
 SL10	10 mm	72 x 52 x 19 mm	IP67	10-30 V dc	Bipolar NPN/PNP	147
 SL30	30 mm	72 x 52 x 19 mm	IP67	10-30 V dc	Bipolar NPN/PNP	146
 VSM	250 mm	4 x 36.8 mm	IP67	10-30 V dc	PNP or NPN	154
 VS2	3 m	25 x 12 x 4 mm	IP67; NEMA 6	10-30 V dc	PNP or NPN	158
 QM26	8.5 m	45 x 14 x 25 mm	IP67, IP69K	10-30 V dc	PNP or NPN	298







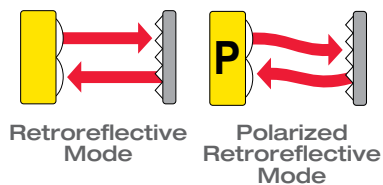



\* AC models are solid-state











# SENSOR SELECTION GUIDE



The sensor contains both the emitter and receiver elements. The effective beam is established by the size of the retroreflector. As with an opposed-mode sensor, an object is sensed when it interrupts or breaks the effective beam.

Model	Range	Dims (H x W x D)	IP Rating	Power Supply	Output	Page #
 QS18	Retro: 6.5 m Polar Retro: 3.5 m	35 x 15 x 31 mm	IP67; NEMA 6P	10-30 V dc 20-140 V ac/dc 20-270 V ac/dc	DC: PNP or NPN P-MOSFET N-MOSFET	40
 QS30	Retro: 12 m Polar Retro: 8 m	44 x 22 x 35 mm	IP67; NEMA 6	10-30 V dc 12-250 V ac/dc 24-250 V ac/dc	DC: Bipolar NPN/PNP AC/DC: SPDT e/m relay	56
 Q12	Retro: 1.5 m Polar Retro: 1 m	23 x 8 x 12 mm	IP67	10-30 V dc	Bipolar NPN/PNP, PNP or NPN	66
 Q20	Retro: 6 m Polar Retro: 4 m	35 x 15 x 31 mm	IP67; NEMA 6P	10-30 V dc	PNP or NPN	70
 MINI-BEAM	Retro: 5 m Polar Retro: 3 m	31 x 12 x varies	IP67; NEMA 4X	10-30 V dc 24-240 V ac 5-15 V dc (NAMUR)	DC: Bipolar NPN/PNP AC: SPST* or SPDT Relay NAMUR: Constant current	76
 Q25	Polar Retro: 2 m	50 x 25 x 30 mm	IP67; NEMA 6P	10-30 V dc or 20-250 V ac	DC: PNP or NPN AC: SPST*	78
 Q40	Polar Retro: 6 m	70 x 40 x 46 mm	IP67; NEMA 6P	10-30 V dc or 20-250 V ac	DC: PNP or NPN AC: SPST*	80
 Q45	Retro: 9 m Polar Retro: 6 m	88 x 45 x 55 mm	IP67; NEMA 6P	10-30 V dc 90-250 V ac 24-250 V ac/dc 12-250 V ac/dc 5-15 V dc (NAMUR)	DC: Bipolar NPN/PNP AC: SPST or SPDT Relay AC/DC: SPST or SPDT Relay NAMUR: Constant current	84
 QMT42	Polar Retro: 3 m	58 x 18 x 42 mm	IP67; NEMA 6P	10-30 V dc	PNP or NPN	95
 T18	Retro: 2 m Polar Retro: 2 m	DC: 42 x 30 x 30 mm AC: 52 x 30 x 30 mm	IP67; NEMA 6P	10-30 V dc 20-250 V ac	DC: PNP or NPN AC: SPST*	102
 TM18	Polar Retro: 5.5 m	41 x 30 x 30 mm	IP67 or IP69K	10-30 V dc	PNP or NPN	106

\* AC models are solid-state



Model	Range	Dims (H x W x D)	IP Rating	Power Supply	Output	Page #
 T30	<b>Polar Retro:</b> 6 m	52 x 40 x 45 mm	IP67; NEMA 6P	10-30 V dc or 20-250 V ac	<b>DC:</b> PNP or NPN <b>AC:</b> SPST*	110
 M12	<b>Retro:</b> 2.5 m <b>Polar Retro:</b> 1.5 m	12 x 67.5 mm	IP67; NEMA 6P	10-30 V dc	PNP or NPN	116
 S18	<b>Retro:</b> 2 m <b>Polar Retro:</b> 2 m	<b>DC:</b> ø 18 x 59 mm <b>AC:</b> ø 18 x 85 mm	IP67; NEMA 6P	10-30 V dc or 20-250 V ac	<b>DC:</b> PNP or NPN <b>AC:</b> SPST*	124
 M18	<b>Retro:</b> 2 m <b>Polar Retro:</b> 2 m	ø 18 x 59 mm	IP67; NEMA 6P	10-30 V dc or	PNP or NPN	126
 S30	<b>Polar Retro:</b> 6 m	<b>DC:</b> ø 30 x 69 mm <b>AC:</b> ø 30 x 81 mm	IP67; NEMA 6P	10-30 V dc or 20-250 V ac	<b>DC:</b> PNP or NPN <b>AC:</b> SPST*	140
 VS3	<b>Polar Retro:</b> 250 mm	26 x 9 x 16 mm	IP67; NEMA 6	10-30 V dc	PNP or NPN	160
 QM26	<b>Polar Retro:</b> 3 m	45 x 14 x 25 mm	IP67, IP69K	10-30 V dc	PNP or NPN	298
 Q26	<b>Polar Retro:</b> 800 mm	52 x 14 x 25 mm	IP67; NEMA 6	10-30 V dc	PNP or NPN	318

\* AC models are solid-state

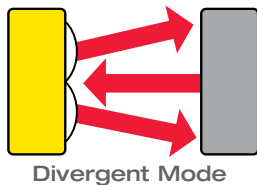
# SENSOR SELECTION GUIDE



Light from the emitter strikes a surface of an object at some arbitrary angle and is diffused from the surface at all angles. The emitted beam and receiver's field-of-view are very wide.

Model	Range	Dims (H x W x D)	IP Rating	Power Supply	Output	Page #
 QS18	300 mm	35 x 15 x 31 mm	IP67; NEMA 6P	10-30 V dc	PNP or NPN	45
 MINI-BEAM	130 mm	31 x 12 x varies	IP67; NEMA 4X	10-30 V dc, 24-240 V ac, 5-15 V dc (NAMUR)	<b>DC:</b> Bipolar NPN/PNP <b>AC:</b> SPST* or SPDT Relay <b>NAMUR:</b> Constant Current	76

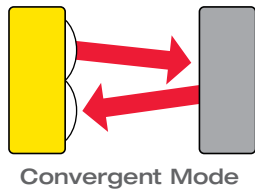

Uses additional optics to create a small, intense and well-defined spot at a fixed distance from the front of the sensor lens.

Model	Range	Dims (H x W x D)	IP Rating	Power Supply	Output	Page #
 QS18	43 mm	35 x 15 x 31 mm	IP67; NEMA 6P	10-30 V dc	PNP or NPN	40
 Q45	100 m	88 x 45 x 55 mm	IP67; NEMA 6P	10-30 V dc 90-250 V ac 24-250 V ac/dc 12-250 V ac/dc 5-15 V dc (NAMUR)	Bipolar NPN/PNP <b>AC:</b> SPST* or SPDT Relay <b>AC/DC:</b> SPST* or SPDT Relay <b>NAMUR:</b> Constant current	84
 MINI-BEAM	49 mm	31 x 12 x varies	IP67; NEMA 4X	10-30 V dc 24-240 V ac 5-15 V dc (NAMUR)	<b>DC:</b> Bipolar NPN/PNP <b>AC:</b> SPST* or SPDT Relay <b>NAMUR:</b> Constant Current	76
 PICO-DOT®	305 mm	40.6 x 12.7 x 45.6 mm	IP67; NEMA 6	10-30 V dc	PNP or NPN	92
 VS1	15 mm	26 x 8 x 12 mm	IP67; NEMA 6	10-30 V dc	PNP or NPN	156
 VS2	30 mm	25 x 12 x 4 mm	IP67; NEMA 6	10-30 V dc	PNP or NPN	158

\* AC models are solid-state

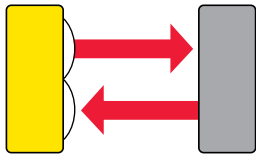

Light from the emitter strikes a surface of an object at some arbitrary angle and is diffused from the surface at all angles.

Diffuse Mode

Model	Range	Dims (H x W x D)	IP Rating	Power Supply	Output	Page #
 Q4X	600 mm	<b>Q4XT</b> 57.4 x 18 x 43.6 mm <b>Q4XF</b> 57.4 x 18 x 32.5 mm	IP67, IP68, IP69K	10-30 V dc	NPN or PNP Dual Discrete with IO-Link 4-20 mA or 0-10 V	34
 QS18	800 mm	35 x 15 x 31 mm	IP67; NEMA 6P	10-30 V dc 20-140 V ac/dc 20-270 V ac/dc	<b>DC:</b> PNP or NPN <b>AC/DC:</b> P-MOSFET or N-MOSFET	40
 QS30	1.4 m	44 x 22 x varies	IP67; NEMA 6	10-30 V dc	Bipolar NPN/PNP	56
 Q20	1.5 m	35 x 15 x 31 mm	IP67; NEMA 6P	10-30 V dc	NPN or PNP	70
 Q45	3 m	88 x 45 x 55 mm	IP67; NEMA 6P	10-30 V dc 90-250 V ac 24-250 V ac 12-250 V dc or 5-15 V dc (NAMUR)	Bipolar NPN/PNP <b>DC:</b> SPST* or SPDT Relay <b>AC:</b> SPST* or SPDT Relay SPST or SPDT Relay <b>NAMUR:</b> Constant current	84
 MINI-BEAM	380 mm	31 x 12 x varies	IP67; NEMA 4X	10-30 V dc, 24-240 V ac, 5-15 V dc (NAMUR)	<b>DC:</b> Bipolar NPN/PNP <b>AC:</b> SPST <b>NAMUR:</b> Constant current	76
 QM42	400 mm	42 x 12.7 x 42 mm	IP67; NEMA 6P	10-30 V dc	NPN or PNP	94
 QMT42	6 m	58 x 18 x 42 mm	IP67; NEMA 6P	10-30 V dc	NPN or PNP	95
 T18 DC	500 mm	42 x 30 x 30 mm	IP67; NEMA 6P	10-30 V dc	NPN or PNP	102
 T18 AC	300 mm	52 x 30 x 30 mm	IP67; NEMA 6P	10-30 V dc	<b>AC:</b> SPST*	103
 TM18	500 mm	41 x 30 x 30 mm	IP67; NEMA 6P or IP69K (when QD PVC jacket is protected)	10-30 V dc	NPN or PNP	106
 S18	300 mm	<b>DC:</b> ø 18 x 59 mm <b>AC:</b> ø 18 x 85 mm	IP67; NEMA 6P	10-30 V dc or 20-250 V ac	NPN or PNP <b>AC:</b> SPST*	124
 M18	300 mm	ø 18 x 59 mm	IP67; NEMA 6P	10-30 V dc	<b>DC:</b> PNP or NPN	126
 VSM	90 mm	4 x 36.8 mm	IP67	10-30 V dc	<b>DC:</b> PNP or NPN	154

\* AC models are solid-state





## Photoelectric

A photoelectric sensor is an optical control used in a variety of automated processes. It works by detecting a visible or invisible beam of light, and responding to a change in the received light intensity. Banner supplies sensors to virtually all the manufacturing companies in the Fortune 500. Banner offers the world's most complete line of photoelectric sensors – over 12,000.



# PHOTOELECTRIC

---

FEATURED	page 34
RECTANGLE	page 74
RIGHT ANGLE	page 105
BARREL	page 130
SLOT & AREA	page 142
MINIATURE	page 152
FIBER OPTICS	page 162



## Featured

The featured sensors are the most versatile sensors available in the photoelectric line. Featured sensors have a variety of mounting styles and options, housing options, configuration modes, ranges, response speeds and many more. Start here to find solutions that meet your sensing needs.

Series	Description	Max Sensing Range	Dimensions (H x W x D)	Protection Rating	Housing Material	Power Supply
	<b>Q4X</b> The Q4X is a versatile, rugged, laser distance sensor that solves the most challenging applications. page 34	<b>Laser Adjustable-Field:</b> 25-610 mm	<b>Q4XT</b> 57.4 x 18 x 43.6 mm  <b>Q4XF</b> 57.4 x 18 x 32.5 mm	IP67 IP68 IP69K	Stainless Steel	10 to 30 V dc
	<b>Q3X</b> The Q3X is a versatile, rugged, laser contrast sensor that solves challenging applications. page 38	<b>Laser Diffuse:</b> 300 mm <b>Fixed-Field:</b> 200 mm	48.6 x 18 x 24.3 mm	IP67 IP68 IP69K	Nickel-plated Zinc	10 to 30 V dc
	<b>QS18</b> General purpose sensor to solve most applications page 40	<b>Opposed:</b> 20 m <b>Laser Emitter:</b> 15 m <b>Retro:</b> 6.5 m <b>Polarized Retro:</b> 3.5 m <b>Laser Retro Polarized:</b> 10 m <b>Convergent:</b> 43 mm <b>Diffuse:</b> 1 m <b>Laser Diffuse:</b> 300 mm <b>Fixed-Field:</b> 100 mm <b>Adjustable-Field:</b> 300 mm <b>Laser Adjustable-Field:</b> 250 mm	Varies by model	IP67 NEMA 6	ABS	10 to 30 V dc 20 to 140 V ac/dc 20 to 270 V ac/dc
	<b>QS30</b> Performance sensor page 56	<b>Opposed:</b> 213 m <b>Opposed Water Dect:</b> 8 m <b>Retro:</b> 12 m <b>Retro Clear Object:</b> 2 m <b>Polarized Retro:</b> 8 m <b>Laser Polarized Retro:</b> 18 m <b>Diffuse:</b> 1.4 m <b>Laser Diffuse:</b> 800 mm <b>Fixed-Field:</b> 600 mm <b>Adjustable-Field:</b> 600 mm	Varies by model	IP67 NEMA 6P	ABS	10 to 30 V dc 24 to 250 V ac 12 to 250 V dc
	<b>Q12</b> Self-contained miniature sensor page 66	<b>Opposed:</b> 2 m <b>Retro:</b> 1.5 m <b>Polarized Retro:</b> 1 m <b>Fixed-Field:</b> 50 mm	22 x 8 x 12.4 mm	IP67	Thermoplastic Elastomer	10 to 30 V dc
	<b>Q20</b> Universal housing page 70	<b>Opposed:</b> 20 m <b>Retro:</b> 6 m <b>Polarized Retro:</b> 4 m <b>Diffuse:</b> 1.5 m <b>Fixed-Field:</b> 150 mm	32 x 12 x 29 mm	IP67 NEMA 6	ABS	10 to 30 V dc

# Q4X Series

Versatile, Rugged, Laser Measurement Sensor



- Save time and money with the Q4X which is **ready to measure right out of the box**
- A simple user experience from installation to setup
  - Bright spot alignment
  - Three push buttons simplify setup
  - Intuitive menus
- Four-digit display **shows distance to target in mm**
- **FDA-grade stainless steel** is suitable for IP69K washdown environments

### Error-Proofing

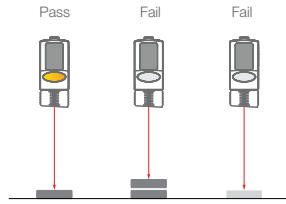

Distance	✓	✗	✓
Color	✓	✓	✗

### Measurement

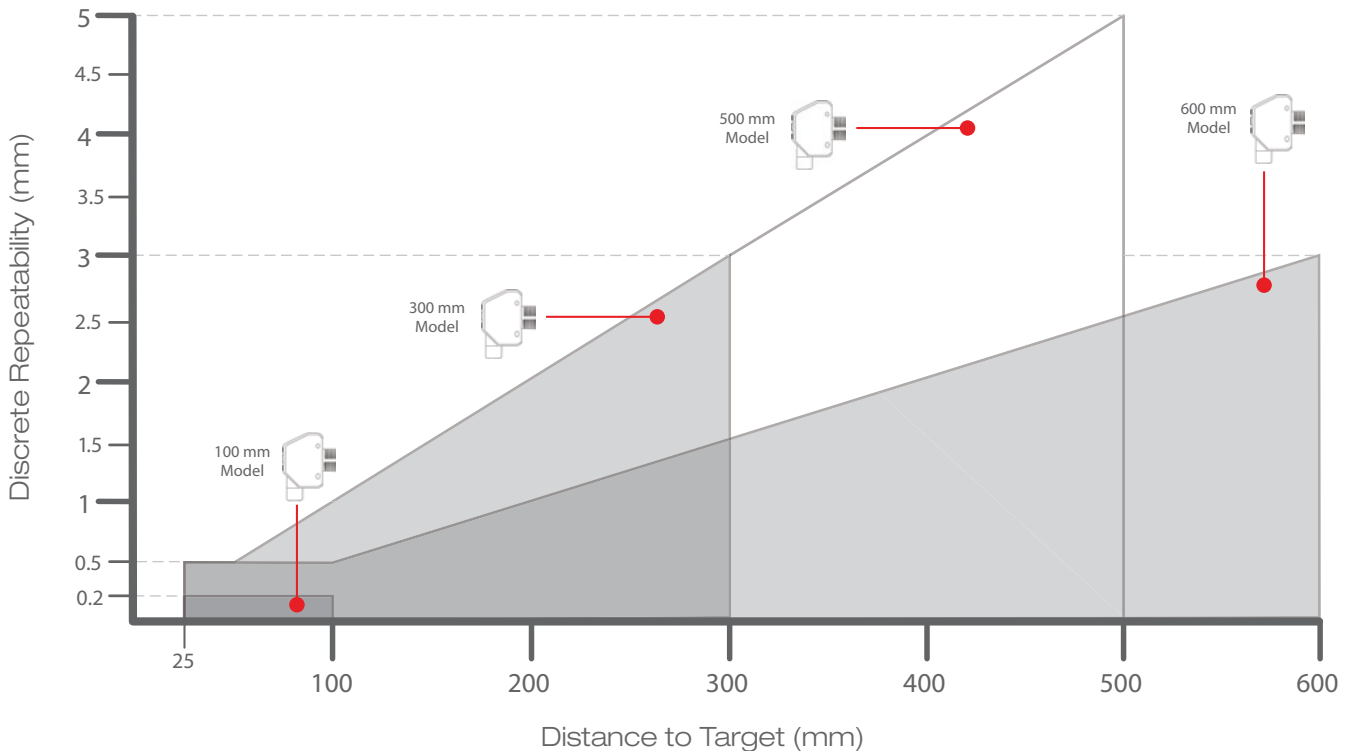
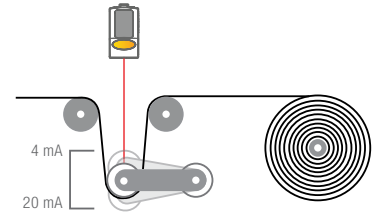





Cordsets for Analog Models

0 to 10 V, 4 to 20 mA

M12/Euro-Style with Shield

Straight connector models listed; for right-angle, add RA to the end of the model number (example, MQDEC2-506RA)



5-Pin  
**MQDEC2-506**  
 2 m (6.5')  
**MQDEC2-515**  
 5 m (15')  
**MQDEC2-530**  
 9 m (30')

M12/Euro-Style Washdown (IP68) with Shield

Straight connector models only



5-Pin  
**MQDCWD-506**  
 2 m (6.5')  
**MQDCWD-530**  
 9 m (30')

Additional cordset information is available  
 See page 758

Cordsets for Other Models

Dual Discrete (4-pin) and Bipolar NPN & PNP (5-pin)

M12/Euro-Style

Straight connector models listed; for right-angle, add RA to the end of the model number (example, MQDC1-506RA)



4-Pin	5-Pin
<b>MQDC-406</b>	<b>MQDC1-506</b>
2 m (6.5')	2 m (6.5')
<b>MQDC-415</b>	<b>MQDC1-515</b>
5 m (15')	5 m (15')
<b>MQDC-430</b>	<b>MQDC1-530</b>
9 m (30')	9 m (30')

M12/Euro-Style Washdown (IP69K)

Straight connector models only



4-Pin	5-Pin
<b>MQDC-WDSS-0406</b>	<b>MQDC-WDSS-0506</b>
2 m (6.5')	2 m (6.5')
<b>MQDC-WDSS-0415</b>	<b>MQDC-WDSS-0515</b>
5 m (15')	5 m (15')
<b>MQDC-WDSS-0430</b>	<b>MQDC-WDSS-0530</b>
9 m (30')	9 m (30')

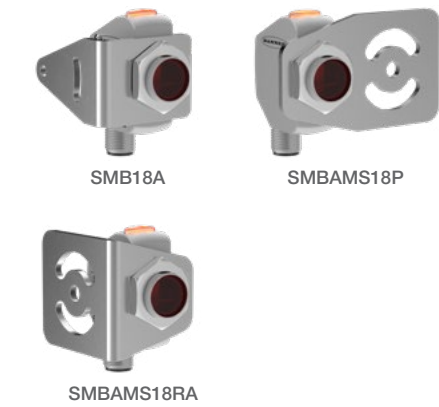

SMB18A

SMBAMS18P

SMBAMS18RA

SMB46L2



**SMBQ4XFA**  
 includes 3/8" bolt  
 for mounting

**SMBQ4XFAM10**  
 includes 10 mm  
 bolt for mounting

**SMBQ4XFAM12**  
 clamps directly onto industry standard  
 bracket systems of 1/2" or 12 mm rods

Additional bracket information is available  
 See page 722





Q4XT.. models



Q4XF.. models

Q4X Specifications

<b>Supply Voltage and Current</b>	10 to 30 V dc at less than 675 mW 12 to 30 V dc for Analog models					
<b>Laser Characteristics</b>	<b>Wavelength:</b> Class 1 Laser: 655 nm visible red					
<b>Beam Spot Size</b>	<b>Short Range Models</b>			<b>Long Range Models</b>		
	<b>Distance (mm)</b>		<b>Size (Horizontal x Vertical)</b>	<b>Distance (mm)</b>		<b>Size (Horizontal x Vertical)</b>
	<b>Threaded</b>	<b>Flush</b>		<b>Threaded</b>	<b>Flush</b>	
25	35	2.4 mm x 1.0 mm	25	35	2.6 mm x 1.0 mm	
50	60	2.3 mm x 0.9 mm	150	160	2.3 mm x 0.9 mm	
100	110	1.8 mm x 0.7 mm	300	310	2.0 mm x 0.8 mm	
			600	610	1.9 mm x 1.0 mm	
<b>Output Response Time</b>	<b>User selectable:</b> 50 ms, 25 ms, 10 ms, 3 ms and 1.5 ms					
<b>Excess Gain</b>	HIGH Excess Gain (STANDARD Excess Gain*)					
	<b>Excess Gain (90% white card)</b>					
<b>Response Speed (ms)</b>	<b>Threaded at 25 mm Flush at 35 mm</b>	<b>Threaded at 100 mm Flush at 110 mm</b>	<b>Threaded at 300 mm Flush at 310 mm</b>			
1.5	200	100	20			
3	200	100	20			
10	1000 (500*)	500 (250*)	100 (50*)			
25	2500 (1000*)	1250 (500*)	250 (100*)			
50	5000 (2500*)	2500 (1250*)	500 (250*)			
* Std excess gain provides increased noise immunity (only available in 50 ms, 25 ms, 10 ms)						
<b>Response Speed (ms)</b>	<b>Threaded at 25 mm Flush at 35 mm</b>	<b>Threaded at 100 mm Flush at 110 mm</b>	<b>Threaded at 300 mm Flush at 310 mm</b>	<b>Threaded at 600 mm Flush at 610 mm</b>		
2	280	110	25	6		
5	280	110	25	6		
15	1000 (360)	400 (150)	80 (30)	20 (7)		
25	2000 (1000)	800 (400)	160 (80)	40 (20)		
50	4000 (2000)	1600 (800)	320 (160)	80 (40)		
<b>Resolution &amp; Linearity</b>	See datasheet for more information on analog models					
<b>Construction</b>	Housing 316 L stainless steel; PMMA acrylic lens cover, Polysulfone lightpipe and display window					
<b>Ambient Light Immunity</b>	Greater than 5,000 lux at 300 mm > 2,000 lux at 500 mm					
<b>Environmental Rating</b>	IP67 per IEC60529; IP68 per IEC60529; IP69K per DIN40050-9					
<b>Operating Conditions</b>	<b>Temperature:</b> -10 °C to +50 °C <b>Humidity:</b> 35% to 95% relative humidity					
<b>Certifications</b>	   chemical compatibility on some models; contact Banner Engineering for details					

# Q3X Series

## Versatile, Rugged, Laser Contrast Sensors



- Solves contrast applications capturing **up to 2,000 events a second**
- Rugged metal, laser-marked housing for use in environments with chemical and oil exposure
- **Three-digit display** offers immediate feedback for easy setup and troubleshooting
- Bright output indicator provides high visibility of sensor operation
- Superior resistance to ambient light interference

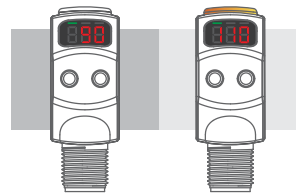

Can detect small changes in contrast up to 300 mm

### Q3X

Example Model Number: Q3XTBLD-Q8

Family	Housing Style	Output	Mode & Range	Connector
<b>Q3X</b>	<b>T</b>	<b>B</b>	<b>LD</b>	<b>Q8</b>
	T = 18 mm Threaded Barrel	B = Bipolar (NPN & PNP)	LD = Laser Diffuse, 300 mm LD50 = Laser Diffuse, 50 mm (60 mm background suppression) LD100 = Laser Diffuse, 100 mm (120 mm background suppression) LD150 = Laser Diffuse, 150 mm (190 mm background suppression) LD200 = Laser Diffuse, 200 mm (280 mm background suppression)	Q8 = 5-pin Integral QD

 Connection Option: A model with a QD requires a mating cordset.



**M12/Euro-Style**  
Straight connector models listed; for right-angle, add **RA** to the end of the model number (example, MQDC1-506RA)



5-Pin

- MQDC1-501.5  
0.5 m (1.5')
- MQDC1-506  
2 m (6')
- MQDC1-515  
5 m (15')
- MQDC1-530  
9 m (30')



**SMBQ4XFA**  
includes 3/8" bolt for mounting

**SMBQ4XFAM10**  
includes 10 mm bolt for mounting



SMB18A

**M12/ Euro-Style Washdown (IP69K)**  
Straight connector models only



5-Pin

- MQDC-WDSS-0506  
2 m (6')
- MQDC-WDSS-0515  
5 m (15')
- MQDC-WDSS-0530  
9 m (30')

**SMBQ4XFAM12**

clamps directly onto industry standard bracket systems of 1/2" or 12 mm rods

*Additional bracket information is available  
See page 722*

*Additional cordset information is available  
See page 758*

**Q3X Specifications**

<b>Supply Voltage and Current</b>	10 to 30 V dc														
<b>Laser Characteristics</b>	<b>Wavelength:</b> Class 2 Laser (655 nm visible red)														
<b>Supply Protection Circuitry</b>	Protected against reverse polarity and transient voltages														
<b>Beam Spot Size</b>	For models LD, LD100, LD150, LD200 (LD50 models*) <table border="1" style="margin-left: 20px;"> <thead> <tr> <th>Distance (mm)</th> <th>Size (Horizontal x Vertical)</th> </tr> </thead> <tbody> <tr> <td>20</td> <td>5.9 mm x 2.3 mm (4.8 mm x 2.0 mm*)</td> </tr> <tr> <td>50</td> <td>5.6 mm x 2.1 mm (3.4 mm x 1.4 mm*)</td> </tr> <tr> <td>100</td> <td>5.1 mm x 1.9 mm</td> </tr> <tr> <td>150</td> <td>4.6 mm x 1.6 mm</td> </tr> <tr> <td>200</td> <td>4.1 mm x 1.6 mm</td> </tr> <tr> <td>300</td> <td>3.0 mm x 1.2 mm</td> </tr> </tbody> </table>	Distance (mm)	Size (Horizontal x Vertical)	20	5.9 mm x 2.3 mm (4.8 mm x 2.0 mm*)	50	5.6 mm x 2.1 mm (3.4 mm x 1.4 mm*)	100	5.1 mm x 1.9 mm	150	4.6 mm x 1.6 mm	200	4.1 mm x 1.6 mm	300	3.0 mm x 1.2 mm
Distance (mm)	Size (Horizontal x Vertical)														
20	5.9 mm x 2.3 mm (4.8 mm x 2.0 mm*)														
50	5.6 mm x 2.1 mm (3.4 mm x 1.4 mm*)														
100	5.1 mm x 1.9 mm														
150	4.6 mm x 1.6 mm														
200	4.1 mm x 1.6 mm														
300	3.0 mm x 1.2 mm														
<b>Output Configuration</b>	Bipolar (1 PNP & 1 NPN) output <b>Off-state leakage current:</b> less than 10 µA <b>PNP On-state saturation voltage:</b> less than 200 mV at 10 mA load and less than 1.0 V at 100 mA <b>NPN On-state saturation voltage:</b> less than 1.0 V at 10 mA load and less than 2.0 V at 100 mA														
<b>Output Response Time</b>	<b>User selectable:</b> 250 µs, 1 ms and 5 ms														
<b>Delay at Power-up</b>	1 second														
<b>Ambient Light Immunity</b>	Greater than 5000 lux														
<b>Repeatability</b>	60 µs														
<b>Construction</b>	Housing nickel-plated zinc die-cast; PMMA acrylic lens cover														
<b>Environmental Rating</b>	IP67 per IEC60529; IP68 per IEC60529; IP69K per DIN40050-9														
<b>Connections</b>	5-pin Euro M12 Integral Connector														
<b>Performance Curves</b>	See datasheet														
<b>Operating Conditions</b>	<b>Temperature:</b> -10 °C to +55 °C <b>Humidity:</b> 35% to 95% relative humidity														



Certifications



# QS18 Series

## Versatile Sensor for Global Manufacturing Needs



- **All-purpose sensors** solve the widest variety of sensing applications
- Versatile sensor with **many mounting options**
- Meets **IP67** and **NEMA 6** standards for use in harsh environments
- Universal housing for global use
- Cordsets and brackets see page 51



**QS18**

**page 42**

The QS18 Standard Sensor requires little to no adjustment. The sensor is available in multiple sensing modes and has a wide variety of connection options.



**QS18 Expert™**

**page 44**

The QS18 Expert™ offers advanced sensing with single push-button programming and several sensing modes and configuration options.



**QS18 Clear Object**

**page 45**

The QS18 Clear Object sensor is designed for clear object detection in plastic or glass containers.

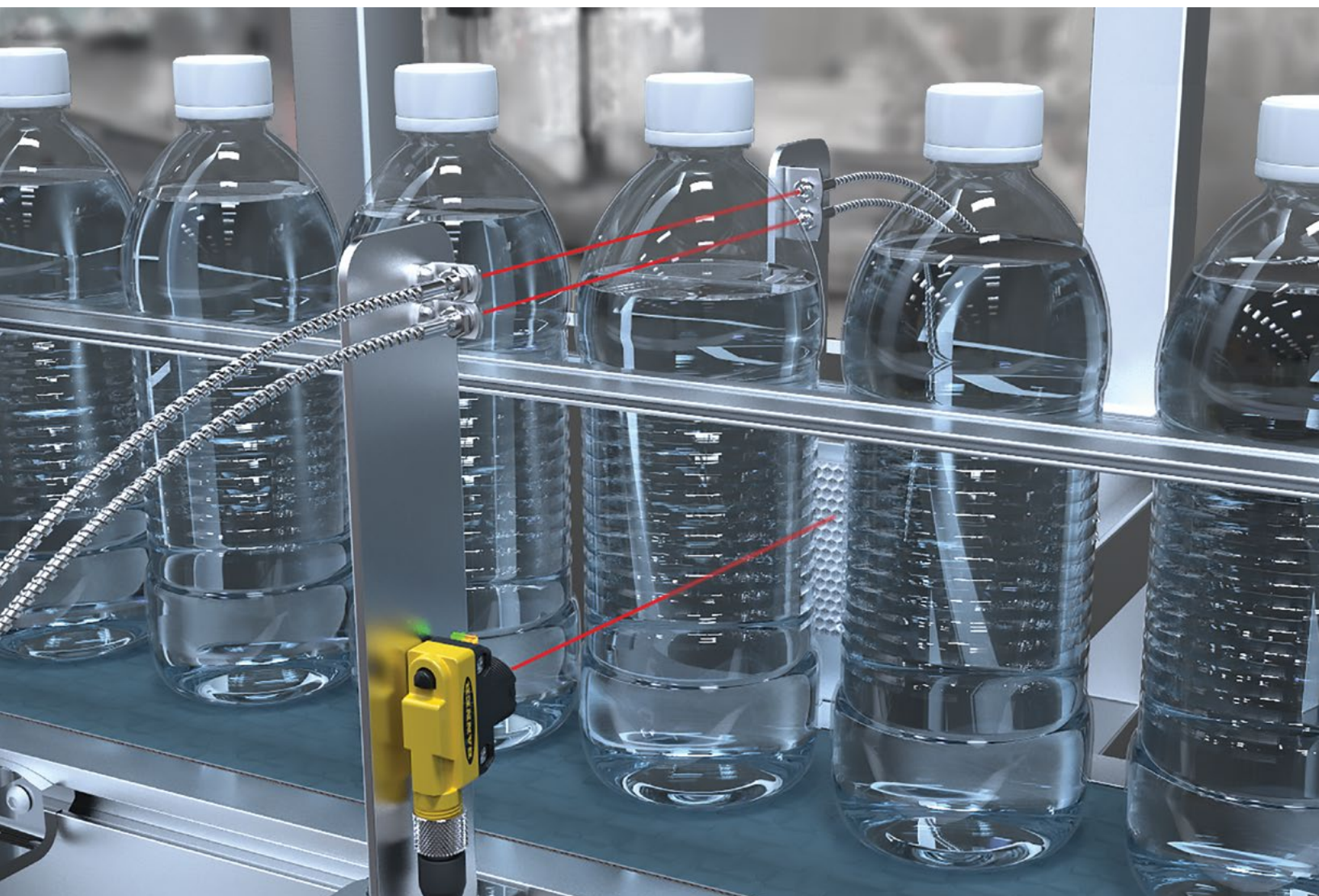

**QS18 Laser**      **page 46**

The QS18 Laser Sensor has a narrow visible beam spot for easy alignment and small object detection.



**QS18 Adjustable-Field**      **page 48**

The QS18 Adjustable-Field Sensor is ideal for background and foreground suppression. The sensor is available in long-range models for sensing up to 300 mm.



**QS18 Universal Voltage**      **page 50**

The QS18 Universal Voltage Sensor operates on ac or dc voltage and has several sensing modes available, making it an ideal sensor for many manufacturing environments.

# QS18



## DC-Operated Sensors



- All-purpose sensor solves widest variety of sensing applications
- Simple set-up with 270 degree potentiometer and fixed sensitivity models
- Versatile sensor with many mounting options
- Meets IP67 and NEMA 6 standards for use in wet environments
- Universal housing for global use
- Cordsets and brackets see page 51

### Opposed QS18

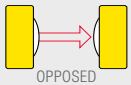
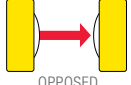
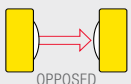
⇨ Infrared LED    → Visible Red LED

Sensing Mode	Range	Connection	Models NPN*	Models PNP*
 OPPOSED	20 m	2 m	QS186E Emitter	
		4-pin Euro QD	QS186EQ8 Emitter	
 OPPOSED	20 m	2 m	QS18VN6R	QS18VP6R
		4-pin Euro QD	QS18VN6RQ8	QS18VP6RQ8
 OPPOSED	3 m	2 m	QS186EB Emitter	
		4-pin Euro QD	QS186EBQ8 Emitter	
 OPPOSED	3 m	2 m	QS18VN6RB	QS18VP6RB
		4-pin Euro QD	QS18VN6RBQ8	QS18VP6RBQ8





### Box Sorting for Size

Three QS18 opposed mode sensors above the roller conveyor detect any passing object, triggering the horizontal QS18 sensor. Boxes are diverted by size as they continue forward.

### Retro & Polar Retro QS18

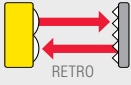
→ Visible Red LED

Sensing Mode	Range	Connection	Models NPN*	Models PNP*
 RETRO	6.5 m <sup>†</sup>	2 m	QS18VN6LV	QS18VP6LV
		4-pin Euro QD	QS18VN6LVQ8	QS18VP6LVQ8
 POLAR RETRO	3.5 m <sup>†</sup>	2 m	QS18VN6LP	QS18VP6LP
		4-pin Euro QD	QS18VN6LPQ8	QS18VP6LPQ8

For more specifications see page 52.

Connection options: A model with a QD requires a mating cordset (see page 51).

For 9 m cable, add suffix W/30 to the 2 m model number (example, QS18VN6LV W/30).

**QD models**

- For 4-pin integral Pico-style QD, add suffix Q7 (example, QS18VN6LVQ7).
- For 4-pin 150 mm Euro-style pigtail QD, add suffix Q5 (example, QS18VN6LVQ5).
- For 4-pin 150 mm Pico-style pigtail QD, add suffix Q (example, QS18VN6LVQ).

<sup>†</sup> Retroreflective range is specified using one model BRT-84 retroreflector.

\* Contact factory at 1-888-373-6767 for Bipolar NPN/PNP output model options.

Actual sensing range may differ, depending on the efficiency and reflective area of the retroreflector used. See Accessories for more information.



Convergent QS18

➔ Visible Red LED

Sensing Mode	Range	Connection	Models NPN*	Models PNP*
 CONVERGENT	16 mm	2 m	QS18VN6CV15	QS18VP6CV15
		4-pin Euro QD	QS18VN6CV15Q8	QS18VP6CV15Q8
 CONVERGENT	43 mm	2 m	QS18VN6CV45	QS18VP6CV45
		4-pin Euro QD	QS18VN6CV45Q8	QS18VP6CV45Q8

Diffuse QS18

➔ Infrared LED

Sensing Mode	Range	Connection	Models NPN*	Models PNP*
 DIFFUSE	450 mm	2 m	QS18VN6D	QS18VP6D
		4-pin Euro QD	QS18VN6DQ8	QS18VP6DQ8
 DIFFUSE	450 mm	2 m	QS18VN6DB	QS18VP6DB
		4-pin Euro QD	QS18VN6DBQ8	QS18VP6DBQ8
 DIFFUSE	600 mm	2 m	QS18VN6DL	QS18VP6DL
		4-pin Euro QD	QS18VN6DLQ8	QS18VP6DLQ8
 DIVERGENT DIFFUSE	100 mm	2 m	QS18VN6W	QS18VP6W
		4-pin Euro QD	QS18VN6WQ8	QS18VP6WQ8

Fixed-Field QS18

➔ Visible Red LED

Sensing Mode	Range	Connection	Models NPN*	Models PNP*
 FIXED-FIELD	0-50 mm Cutoff	2 m	QS18VN6FF50	QS18VP6FF50
		4-pin Euro QD	QS18VN6FF50Q8	QS18VP6FF50Q8
 FIXED-FIELD	0-100 mm Cutoff	2 m	QS18VN6FF100	QS18VP6FF100
		4-pin Euro QD	QS18VN6FF100Q8	QS18VP6FF100Q8

Coaxial QS18 Clear Object Detection

➔ Visible Red LED

Sensing Mode	Range**	Connection	Models NPN*	Models PNP*
 CLEAR OBJECT RETRO	0-3 m	2 m	QS18VN6XLP	QS18VP6XLP
		4-pin Euro QD	QS18VN6XLPQ8	QS18VP6XLPQ8

For more specifications see page 52.

➔ Connection options: A model with a QD requires a mating cordset (see page 51).

For 9 m cable, add suffix W/30 to the 2 m model number (example, QS18VN6LV W/30).

QD models

- For 4-pin integral Pico-style QD, add suffix Q7 (example, QS18VN6LVQ7).
- For 4-pin 150 mm Euro-style pigtail QD, add suffix Q5 (example, QS18VN6LVQ5).
- For 4-pin 150 mm Pico-style pigtail QD, add suffix Q (example, QS18VN6LVQ).

\* Contact factory at 1-888-373-6767 for Bipolar NPN/PNP output model options.

\*\* For use with BRT-92X92C

Actual sensing range may differ, depending on the efficiency and reflective area of the retroreflector used. See Accessories for more information.

# QS18 Expert™

## Sensors with Push-Button Programming



- Intuitive push-button lock out to prevent accidental configuration changes
- Bright LED status indicators visible from 360°
- Reliable detection of reflective objects
- Cordsets and brackets see page 51

### Polar Retro QS18 Expert™

➔ Visible Red LED

Sensing Mode	Range	Connection	Models NPN*	Models PNP*
 POLAR RETRO	3.5 m†	2 m	QS18EN6LP	QS18EP6LP
		4-pin Euro QD	QS18EN6LPQ8	QS18EP6LPQ8

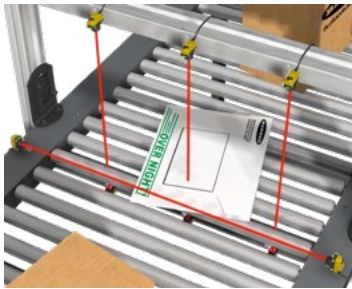

### Mail Sorting for Size

Three QS18 opposed mode sensors above the roller conveyor detect any passing object, triggering the horizontal QS18 sensor. Letters pass below the horizontal QS18 undetected and are diverted to the letter conveyor. Parcels are detected and continue forward.

### Convergent QS18 Expert™

➔ Visible Red LED

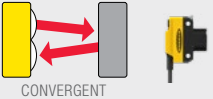
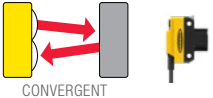
Sensing Mode	Range	Connection	Models NPN*	Models PNP*
 CONVERGENT	16 mm	2 m	QS18EN6CV15	QS18EP6CV15
		4-pin Euro QD	QS18EN6CV15Q8	QS18EP6CV15Q8
 CONVERGENT	43 mm	2 m	QS18EN6CV45	QS18EP6CV45
		4-pin Euro QD	QS18EN6CV45Q8	QS18EP6CV45Q8

For more specifications see page 53.

➔ Connection options: A model with a QD requires a mating cordset (see page 51).

For 9 m cable, add suffix W/30 to the 2 m model number (example, QS18EN6LP W/30).

**QD models**

- For 4-pin integral Pico-style QD, add suffix Q7 (example, QS18EN6LPQ7).
- For 4-pin 150 mm Euro-style pigtail QD, add suffix Q5 (example, QS18EN6LPQ5).
- For 4-pin 150 mm Pico-style pigtail QD, add suffix Q (example, QS18EN6LPQ).

† Retroreflective range is specified using one model BRT-84 retroreflector.

Actual sensing range may differ, depending on the efficiency and reflective area of the retroreflector used. See Accessories for more information.

\* Contact factory at 1-888-373-6767 for Bipolar NPN/PNP output model options.

Diffuse QS18 Expert™

 Infrared LED  Visible Red LED

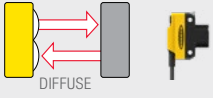
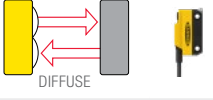
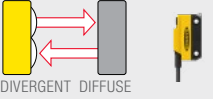
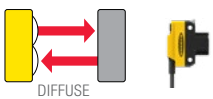
Sensing Mode	Range	Connection	Models NPN*	Models PNP*
 DIFFUSE	800 mm	2 m	QS18EN6D	QS18EP6D
		4-pin Euro QD	QS18EN6DQ8	QS18EP6DQ8
 DIFFUSE	500 mm	2 m	QS18EN6DB	QS18EP6DB
		4-pin Euro QD	QS18EN6DBQ8	QS18EP6DBQ8
 DIVERGENT DIFFUSE	300 mm	2 m	QS18EN6W	QS18EP6W
		4-pin Euro QD	QS18EN6WQ8	QS18EP6WQ8
 DIFFUSE	600 mm	2 m	QS18EN6DV	QS18EP6DV
		4-pin Euro QD	QS18EN6DVQ8	QS18EP6DVQ8

Coaxial QS18 Expert™ Clear Object Detection

 Visible Red LED

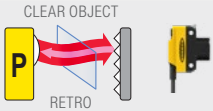
Sensing Mode	Range	Connection	Models NPN*	Models PNP*
 CLEAR OBJECT RETRO	0-3 m	2 m	QS18EN6XLPC	QS18EP6XLPC
		4-pin Euro QD	QS18EN6XLPCQ8	QS18EP6XLPCQ8

Coaxial QS18 Expert™ Clear Object Detection with IO-Link

 Visible Red LED

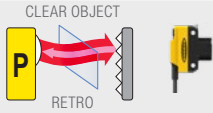
Sensing Mode	Range	Connection	Models
 CLEAR OBJECT RETRO	0-3 m	2 m	QS18EK6XLPC
		4-pin Euro QD	QS18EK6XLPCQ8

Plastic Fiber QS18 Expert™

 Visible Red LED

Sensing Mode	Range	Connection	Models NPN*	Models PNP*
 PLASTIC FIBER	Range varies by sensing mode and fiber optics used	2 m	QS18EN6FP	QS18EP6FP
		4-pin Euro QD	QS18EN6FPQ8	QS18EP6FPQ8

For more specifications see page 53.

 Connection options: A model with a QD requires a mating cordset (see page 51).

For 9 m cable, add suffix W/30 to the 2 m model number (example, QS18EN6D W/30).

**QD models**

- For 4-pin integral Pico-style QD, add suffix Q7 (example, QS18EN6DQ7).
- For 4-pin 150 mm Euro-style pigtail QD, add suffix Q5 (example, QS18EN6DQ5).
- For 4-pin 150 mm Pico-style pigtail QD, add suffix Q (example, QS18EN6DQ).

\* Actual sensing range may differ, depending on the efficiency and reflective area of the retroreflector used. See Accessories for more information.

\* Contact factory at 1-888-373-6767 for Bipolar NPN/PNP output model options.

\*\* For use with BRT-92X92C

# QS18 Laser

## DC-Operated Long-Range Laser Sensors



- The QS18 Laser Emitter has a narrow visible beam spot for easy alignment and small object detection.
- Long sensing ranges
- Available in opposed, diffuse and retroreflective mode (see page 48 for adjustable-field models)
- Cordsets and brackets see page 51

### Class 1 Laser QS18

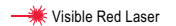

Sensing Mode	Range	Connection	Models NPN*	Models PNP*
	15 m (4500 x excess gain)	2 m 4-pin Euro QD	QS186LE Emitter**	QS186LEQ8 Emitter**
	See datasheet for more information.	2 m 4-pin Euro QD	QS186LE10	QS186LE10Q8
	See datasheet for more information.	2 m 4-pin Euro QD	QS186LE11	QS186LE11Q8
	See datasheet for more information.	2 m 4-pin Euro QD	QS186LE12	QS186LE12Q8
	See datasheet for more information.	2 m 4-pin Euro QD	QS186LE14	QS186LE14Q8
	0.1-10 m†	2 m 4-pin Euro QD	QS18VN6LLP	QS18VP6LLP
	300 mm	2 m 4-pin Euro QD	QS18VN6LD	QS18VP6LD
			QS18VN6LLPQ8	QS18VP6LLPQ8
			QS18VN6LDQ8	QS18VP6LDQ8



### Package Inspection Using Diffuse-Mode Laser Sensors

When packaging medical supplies, error-proofing and quality control are of the utmost importance. In this application, it's necessary to inspect each package of gauze pads to ensure that the lid has been closed and that tape has been applied to seal the package. Automating this process means greater efficiency and less chance of error.

For more specifications see page 52.

**Connection options:** A model with a QD requires a mating cordset (see page 51).

For 9 m cable, add suffix **W/30** to the 2 m model number (example, **QS186LE W/30**).

**QD models**

- For 4-pin integral Euro-style QD, add suffix **Q7** (example, **QS186LEQ7**).
- For 4-pin 150 mm Euro-style pigtail QD, add suffix **Q5** (example, **QS186LEQ5**).
- For 4-pin 150 mm Pico-style pigtail QD, add suffix **Q** (example, **QS186LEQ**).

† Retroreflective range is specified using one model BRT-51X51BM or BRT-TVHG-2X2 retroreflector.  
Actual sensing range may differ, depending on the efficiency and reflective area of the retroreflector used. See Accessories for more information.

\* Contact factory at 1-888-373-6767 for Bipolar NPN/PNP output model options.

\*\* Specified with QS18 threaded lens receiver. Not recommended for dusty or dirty environments; the scattered light would greatly reduce excess gain.  
For use with standard QS18 opposed mode receivers

Class 2 Laser QS18

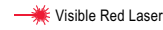

Sensing Mode	Range	Connection	Models*
	15 m (7000 X excess gain)	2 m 4-pin Euro QD	QS186LE2 Emitter** QS186LE2Q8 Emitter**
	See datasheet for more information	2 m 4-pin Euro QD	QS186LE210 QS186LE210Q8
	See datasheet for more information	2 m 4-pin Euro QD	QS186LE211 QS186LE211Q8
	See datasheet for more information	2 m 4-pin Euro QD	QS186LE212 QS186LE212Q8
	See datasheet for more information	2 m 4-pin Euro QD	QS186LE214 QS186LE214Q8

Class 1 Laser Sensors

Lasers that are safe under reasonably foreseeable conditions of operation, including the use of optical instruments for intrabeam viewing. Reference IEC 60825-1: 2001, section 8.2.

Class 2 Lasers

Lasers that emit visible radiation in the wavelength range from 400 nm to 700 nm, where eye protection is normally afforded by aversion responses, including the blink reflex. This reaction may be expected to provide adequate protection under reasonably foreseeable conditions of operation, including the use of optical instruments for intrabeam viewing. Reference IEC 60825-1:2001, section 8.2.

For safe laser use (Class 1 or Class 2):

- Do not permit a person to stare at the laser from within the beam.
- Do not point the laser at a person's eye at close range.
- Terminate the beam emitted by a Class 2 laser product at the end of its useful path.
- Locate open laser beam paths either above or below eye level, where practical.

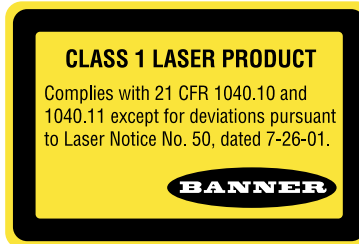

For more specifications see page 52.

Connection options: A model with a QD requires a mating cordset (see page 51).  
 For 9 m cable, add suffix W/30 to the 2 m model number (example, QS186LE2 W/30).  
**QD models**  
 • For 4-pin 150 mm Pico-style pigtail QD, add suffix Q (example, QS186LE2Q).  
 \* Contact factory at 1-888-373-6767 for Bipolar NPN/PNP output model options.  
 \*\* Specified with QS18 threaded lens receiver. Not recommended for dusty or dirty environments; the scattered light would greatly reduce excess gain.



# QS18 Adjustable-Field

## Foreground and Background Suppression Sensors



- The QS18 Adjustable-Field Sensor is ideal for background and foreground suppression
- The sensor is available in long-range models for sensing up to 300 mm
- Background suppression models for detection of objects when the background condition is not fixed
- Foreground suppression models for detection when background is fixed and object varies in color or shape
- Visible red LED or laser sensing beam
- Cordsets and brackets see page 51

### Adjustable-Field Foreground Suppression

Foreground suppression models for reliable detection when a fixed background is present and the object color or shape varies

- Objects detected to the face of the sensor (no dead zone).
- Simple multiturn screw adjustment of cutoff distance
- Enhanced immunity to fluorescent lights
- Crosstalk immunity algorithm allows two sensors to be used in close proximity
- Visible red emitter

### Adjustable-Field Foreground QS18

➔ Visible Red LED

Sensing Mode	Range	Connection	Models NPN*	Models PNP*
ADJUSTABLE-FIELD FOREGROUND	Adjustable between 30-200 mm	2 m	QS18AB6AFF200 (Bipolar NPN/PNP)	
		4-pin Euro Pigtail QD	QS18AB6AFF200Q5 (Bipolar NPN/PNP)	
		2 m	QS18VN6AFF200	QS18VP6AFF200
		4-pin Euro Pigtail QD	QS18VN6AFF200Q5	QS18VP6AFF200Q5
ADJUSTABLE-FIELD FOREGROUND	Adjustable between 15-40 mm	2 m	QS18AB6AFF40 (Bipolar NPN/PNP)	
		4-pin Euro Pigtail QD	QS18AB6AFF40Q5 (Bipolar NPN/PNP)	
		2 m	QS18VN6AFF40	QS18VP6AFF40
		4-pin Euro Pigtail QD	QS18VN6AFF40Q5	QS18VP6AFF40Q5

For more specifications see page 52.

➔ Connection options: A model with a QD requires a mating cordset (see page 51).

For 9 m cable, add suffix W/30 to the 2 m model number (example, QS18VN6AFF200 W/30).  
QD models

• For 4-pin 150 mm Pico-style pigtail QD, add suffix Q (example, QS18EN6LPQ).

\* Contact factory at 1-888-373-6767 for Bipolar NPN/PNP output model options.

Adjustable-Field Background Suppression QS18



Sensing Mode	Range	Connection	Models NPN*	Models PNP*
<p>ADJUSTABLE-FIELD BACKGROUND SUPPRESSION</p>	Adjustable between 30-300 mm	2 m	QS18AB6AF300 (Bipolar NPN/PNP)	
		4-pin Euro Pigtail QD	QS18AB6AF300Q5 (Bipolar NPN/PNP)	
		2 m	QS18VN6AF300	QS18VP6AF300
		4-pin Euro Pigtail QD	QS18VN6AF300Q5	QS18VP6AF300Q5
<p>ADJUSTABLE-FIELD BACKGROUND SUPPRESSION</p>	Adjustable between 15-40 mm	2 m	QS18AB6AF40 (Bipolar NPN/PNP)	
		4-pin Euro Pigtail QD	QS18AB6AF40Q5 (Bipolar NPN/PNP)	
		2 m	QS18VN6AF40	QS18VP6AF40
		4-pin Euro Pigtail QD	QS18VN6AF40Q5	QS18VP6AF40Q5
<p>ADJUSTABLE-FIELD BACKGROUND SUPPRESSION</p>	1 mm to cutoff point (adjustable between 20-100 mm)	2 m	QS18VN6AF100	QS18VP6AF100
		4-pin Euro Pigtail QD	QS18VN6AF100Q5	QS18VP6AF100Q5
<p>LASER (CLASS 1) ADJUSTABLE-FIELD BACKGROUND SUPPRESSION</p>	1 mm to cutoff point (adjustable between 30-150 mm)	2 m	QS18VN6LAF	QS18VP6LAF
		4-pin Euro Pigtail QD	QS18VN6LAFQ5	QS18VP6LAFQ5
<p>LASER (CLASS 2) ADJUSTABLE-FIELD BACKGROUND SUPPRESSION</p>	20 mm to cutoff point (adjustable between 50-250 mm)	2 m	QS18VN6LAF250	QS18VP6LAF250
		4-pin Euro Pigtail QD	QS18VN6LAF250Q5	QS18VP6LAF250Q5

Adjustable-Field Background Suppression

Background suppression models for reliable detection of objects when the background condition is not controlled or fixed

- Simple multiturn screw adjustment of cutoff distance
- Enhanced immunity to fluorescent lights
- Crosstalk immunity algorithm allows two sensors to be used in close proximity
- Visible red emitter

Class 1 Laser Sensors

Lasers that are safe under reasonably foreseeable conditions of operation, including the use of optical instruments for intrabeam viewing. Reference IEC 60825-1: 2001, section 8.2.

Class 2 Lasers

Lasers that emit visible radiation in the wavelength range from 400 nm to 700 nm, where eye protection is normally afforded by aversion responses, including the blink reflex. This reaction may be expected to provide adequate protection under reasonably foreseeable conditions of operation, including the use of optical instruments for intrabeam viewing. Reference IEC 60825-1:2001, section 8.2.

For safe laser use (Class 1 or Class 2):

- Do not permit a person to stare at the laser from within the beam.
- Do not point the laser at a person's eye at close range.
- Terminate the beam emitted by a Class 2 laser product at the end of its useful path.
- Locate open laser beam paths either above or below eye level, where practical.

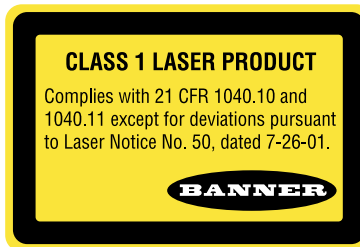

For more specifications see page 52.

**Connection options:** A model with a QD requires a mating cordset (see page 51).

For 9 m cable, add suffix W/30 to the 2 m model number (example, QS18EN6LP W/30).

**QD models**

- For 4-pin 150 mm Euro-style pigtail QD, add suffix Q5 (example, QS18EN6LPQ5).
- For 4-pin 150 mm Pico-style pigtail QD, add suffix Q (example, QS18EN6LPQ).

\* Contact factory at 1-888-373-6767 for Bipolar NPN/PNP output model options.

# QS18 Universal Voltage

## Versatile Sensors Operate on AC or DC Voltage



- The QS18 Universal Voltage Sensor operates on ac or dc voltage
- Versatile sensor with many mounting options
- Ready to hook up out of the box
- Cordsets and brackets see page 51

### Opposed QS18 Universal Voltage, 20-140 V AC/DC or 20-270 V AC/DC

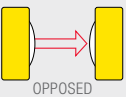
Sensing Mode	Range	Output <sup>††</sup>	Models Light Operate	Models Dark Operate
	20 m	— N-MOSFET (Sinking) P-MOSFET (Sourcing)	QS18WE Emitter	
			QS18ANWR QS18APWR	QS18RNWR QS18RPWR

### Polar Retro & Retro QS18 Universal Voltage, 20-140 V AC/DC or 20-270 V AC/DC

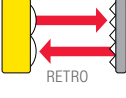
Sensing Mode	Range	Output <sup>††</sup>	Models Light Operate	Models Dark Operate
	3.5 m <sup>†</sup>	N-MOSFET (Sinking) P-MOSFET (Sourcing)	QS18ANWLP QS18APWLP	QS18RNWLP QS18RPWLP
	6.5 m <sup>†</sup>	N-MOSFET (Sinking) P-MOSFET (Sourcing)	QS18ANWLV QS18APWLV	QS18RNWLV QS18RPWLV

### Diffuse QS18 Universal Voltage, 20-140 V AC/DC or 20-270 V AC/DC

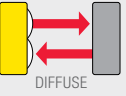
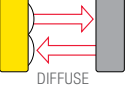
Sensing Mode	Range	Output <sup>††</sup>	Models Light Operate	Models Dark Operate
	450 mm	N-MOSFET (Sinking) P-MOSFET (Sourcing)	QS18ANWDL QS18APWDL	QS18RNWDL QS18RPWDL
	1 m	N-MOSFET (Sinking) P-MOSFET (Sourcing)	QS18ANWDXL QS18APWDXL	QS18RNWDXL QS18RPWDXL



### Conveyor Jam Detection Using Opposed-Mode Sensors

When an object is lodged in front of the sensor an output is triggered, alerting personnel to the presence of the jam. QS18 Universal Voltage sensors can be connected to either ac or dc power, allowing them to operate in applications already using ac power without requiring a separate power supply.

For more specifications see page 53.

 Connection options: A model with a QD requires a mating cordset.

For 9 m cable, add suffix W/30 to the 2 m model number (example, QS18WE W/30).

**QD models**

- For 4-pin 150 mm Micro-style pigtail QD, add suffix Q2 to the model number (example, QS18WEQ2).
- 600 V cable models: Standard models are supplied with 300 V cable. For a 600 V cable, add suffix C1 to the 2 m model number (example, QS18WEC1).

<sup>†</sup> Retroreflective range is specified using one model BRT-84 retroreflector.  
Actual sensing range may differ, depending on the efficiency and reflective area of the retroreflector used. See Accessories for more information.

<sup>††</sup>MOSFET: Metal oxide semiconductor field-effect transistor.

**Euro QD**  
(for ..Q8 or ..Q5 models)  
Straight connector models listed; for right-angle, add **RA** to the end of the model number (example, **MQDC-406RA**)

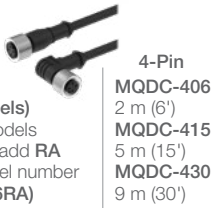

**Pico QD**  
(for Q7 models)  
Straight snap-on connector

**Pico QD (for Q7 models)**  
Right-angle snap-on connector



**Micro QD**  
(for ..Q2 models)  
Straight connector models listed



**Euro QD with Shield**  
(for ..Q8 or ..Q5 models)  
Straight connector models listed; for right-angle, add **RA** to the end of the model number (example, **MQDEC2-406RA**)

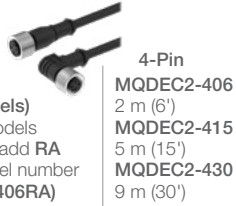

**Pico QD with Shield**  
(for Q7 models)  
Straight snap-on connector

**Pico QD (for Q7 models)**  
Right-angle snap-on connector

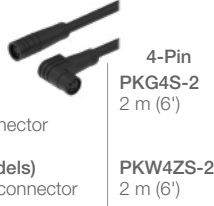

Additional cordset information is available  
See page 758



SMBQ4XFA



SMBQS18A



SMB18A



SMBQ18AF

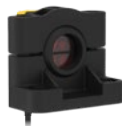

SMB18SF

Additional bracket information is available  
See page 722

Reflectors



Additional information is available  
See page 790

Apertures



Additional information is available  
See page 816



Opposed, Retroreflective, Laser Retroreflective, Convergent, Diffuse, Laser Diffuse and Fixed-Field Models  
Suffix E, R, LV, LP, LLP, CV15, CV45, D, DV, LD, LE and FF



Opposed, Diffuse and Divergent Diffuse Models  
Suffix EB, RB, DB and W



Adjustable-Field Models  
Suffix AFF, AF and LAF



Opposed, Retroreflective, Polar Retroreflective and Diffuse Models  
Suffix E, R, LP, LV, DL and XL





Plastic Fiber Models  
Suffix FP



Glass Fiber Models  
Suffix F

## QS18, DC, Laser, Adjustable-Field Specifications

Supply Voltage and Current	<b>Retroreflective, Diffuse and Adjustable-Field Laser:</b> 10 to 30 V dc (10% max. ripple) at less than 15 mA, exclusive of load <b>Laser Emitters:</b> 10 to 30 V dc (10% max. ripple) at less than 35 mA <b>Adjustable-Field (40, 200 &amp; 300 mm):</b> 10 to 30 V dc (10% max. ripple) at less than 27 mA <b>All Others:</b> 10 to 30 V dc (10% max. ripple) at less than 25 mA, exclusive of load			
Laser Characteristics (Laser models only)	<b>Wavelength: Class 1:</b> 650 nm visible red <b>Class 2:</b> Adjustable-Field—658 nm visible red Laser Emitter—650 nm visible red			
Supply Protection Circuitry	Protected against reverse polarity and transient voltages			
Laser Control (Emitters only)	Apply 0 V dc to white wire to enable beam Apply +10 to 30 V dc to white wire to inhibit beam <b>Enable Time:</b> Class 1—240 ms      Class 2—8 ms <b>Disable time:</b> Class 1—100 ms      Class 2—1 ms			
Output Configuration*	<b>Solid-state complementary:</b> NPN (current sinking), PNP (current sourcing), or bipolar (both sinking and sourcing) depending on model <b>Rating:</b> 100 mA total output current <b>OFF-state leakage current:</b> Adjustable-Field LED (40, 200 & 300 mm), Retroreflective, Diffuse and Adjustable-Field Laser: <b>NPN:</b> less than 200 µA @ 30 V dc (see Application Note 1) <b>PNP:</b> less than 10 µA @ 30 V dc <b>Fixed-Field:</b> less than 200 µA @ 30 V dc <b>All others:</b> less than 50 µA @ 30 V dc <b>ON-state saturation voltage:</b> Adjustable-Field LED (40, 200 & 300 mm), Retroreflective, Diffuse and Adjustable-Field Laser: <b>NPN:</b> less than 1.6 V @ 100 mA <b>PNP:</b> less than 3.0 V @ 100 mA <b>All others:</b> less than 1 V @ 10 mA; less than 1.5 V @ 100 mA Protected against false pulse on power-up and continuous overload or short circuit of outputs			
Output Response Time*	<b>Opposed:</b> 750 microseconds ON; 375 microseconds OFF <b>Retroreflective Laser, Diffuse Laser and Adjustable-Field (100, 150 &amp; 250 mm):</b> 700 microseconds ON/OFF <b>Adjustable-Field (40, 200 &amp; 300 mm):</b> 2.8 milliseconds ON/OFF <b>Fixed-Field:</b> 850 microseconds ON/OFF <b>All others:</b> 600 microseconds ON/OFF			
Delay at Power-up	<b>Laser Emitters:</b> Class 1—250 milliseconds Class 2—10 milliseconds <b>Adjustable-Field LED (40, 200 &amp; 300 mm), Retroreflective, Diffuse and Adjustable-Field Laser:</b> 200 milliseconds; outputs do not conduct during this time. <b>All others:</b> 100 milliseconds; outputs do not conduct during this time.			
Repeatability*	<b>Opposed:</b> 100 microseconds <b>Retroreflective Laser, Diffuse Laser and Adjustable-Field Laser:</b> 130 microseconds <b>Adjustable-Field LED (100 mm):</b> 175 microseconds <b>Adjustable-Field LED (40, 200 &amp; 300 mm):</b> 250 microseconds <b>Fixed-Field:</b> 160 microseconds <b>All Others:</b> 150 microseconds			
Adjustments*	<b>Retro, Retro Laser, Convergent, Diffuse, Diffuse Laser and Glass &amp; Plastic Fiber Optic:</b> Single-turn sensitivity (Gain) adjustment potentiometer <b>Adjustable-Field:</b> Five-turn adjustment screw sets cutoff distance between min. and max. position			
Indicators	<b>Laser Emitters:</b> Green LED: Power applied <b>All others, 2 LED indicators: (Green:</b> Power ON <b>Yellow:</b> Light sensed) See datasheet for detailed information			
Construction	ABS housing; acrylic lens cover (Laser Emitter models have PMMA window) 2.5 mm (adjustable-field only) and 3 mm mounting hardware included			
Environmental Rating	Rated IEC IP67; NEMA 6; UL Type 1			
Connections	2 m or 9 m 4-wire PVC cable, or 4-pin 150 mm pigtail Pico-style QD (Q), or 4-pin 150 mm pigtail Euro-style QD (Q5), or 4-pin Integral Pico-style QD (Q7), or 4-pin Integral Euro-style QD (Q8), depending on model. QD cordsets are ordered separately. See page 51.			
Operating Conditions	<b>Lasers</b>	<b>Adjustable-Field LED (100 mm)</b>	<b>Adjustable-Field LED (40, 200 &amp; 300 mm)</b>	<b>All others</b>
	<b>Temperature:</b>	-10° to +50° C	0° to +55° C	-20° to +70° C
	<b>Relative humidity:</b>	90% @ 50° C (non-condensing)	95% @ 50° C (non-condensing)	95% @ 50° C (non-condensing)
Laser Classification (Laser models only)	Class 1 and Class 2 laser product; complies with IEC 60825-1: 2001 and 21 CFR 1040.10, except deviations pursuant to Laser Notice 50, dated 7-26-01.			
Application Notes	<b>AF models:</b> NPN off-state leakage current is < 200 µA for load resistances > 3 kΩ or optically isolated loads. For load current of 100 mA, leakage is < 1% of load current			
Certifications	All others:   Laser Emitters: 			

\* Does not apply to laser emitter models.



## QS18 *Expert*<sup>TM</sup> Specifications and Clear Object Specifications

Supply Voltage	10 to 30 V dc (10% max. ripple) at less than 35 mA, exclusive of load; 10 to 24 V dc @ greater than 55° C
Supply Protection Circuitry	Protected against reverse polarity and transient voltages
Output Configuration	Solid-state NPN (current sinking) or PNP (current sourcing), depending on model Light (LO) or Dark Operate (DO) selectable Selectable 30 millisecond output OFF-delay <b>Rating:</b> 100 mA max. <b>OFF-state leakage current:</b> less than 50 $\mu$ A @ 30 V dc <b>ON-state saturation voltage:</b> less than 1.5 V (2 m cable); 1.7 V (9 m cable) Protected against false pulse on power-up and continuous overload or short circuit of output
Output Response Time	<b>Expert:</b> 600 microseconds ON/OFF <b>Clear Object Detection:</b> 400 microseconds ON/OFF
Delay at Power-up	Momentary delay on power-up; outputs do not conduct during this time
Repeatability	<b>Expert:</b> 75 microseconds <b>Clear Object Detection:</b> 100 microseconds
Adjustments	<b>Thresholds:</b> Push-button/remote-wire configurable <b>Expert<sup>TM</sup>-style TEACH and SET options:</b> <b>Light/Dark Operate:</b> selectable by programming order (load output follows the first taught target condition) <b>Push-button enable/disable:</b> remote wire only See datasheet for detailed information
Indicators	<b>2 LED indicators: Green:</b> RUN mode, output short-circuit <b>Yellow:</b> Output ON/marginal, TEACH mode
Construction	ABS housing
Environmental Rating	Meets NEMA 6; IEC IP67; UL Type 1
Connections	2 m or 9 m 4-wire PVC cable, or 4-pin 150 mm pigtail Pico-style QD ( <b>Q</b> ), or 4-pin 150 mm pigtail Euro-style QD ( <b>Q5</b> ), or 4-pin Integral Pico-style QD ( <b>Q7</b> ), or 4-pin Integral Euro-style QD ( <b>Q8</b> ). QD cordsets are ordered separately. See page 51.
Operating Conditions	<b>Temperature:</b> -20° to +70° C <b>Relative humidity:</b> 90% @ 50° C (non-condensing)
Certifications	

## QS18 Universal Voltage Specifications

Supply Voltage	<b>P-MOSFET Models:</b> 20 to 140 V ac/dc @ < 10 mA, exclusive of load <b>N-MOSFET Models:</b> 20 to 270 V ac/dc @ < 10 mA, exclusive of load	
Supply Protection Circuitry	Protected against reverse polarity and transient over-voltages	
Output Configuration	Single Discrete Output, 100 mA load rating <b>N-MOSFET or P-MOSFET</b> , depending on model number Light Operate or Dark Operate, depending on model number	
Output Rating	<b>P-MOSFET models</b> 100 mA with short circuit protection <b>OFF-state leakage current:</b> < 400 $\mu$ A <b>ON-state saturation voltage:</b> 2.75 V	<b>N-MOSFET models</b> 100 mA with short circuit protection <b>OFF-state leakage current:</b> < 400 $\mu$ A <b>ON-state saturation voltage:</b> 2.5 V
Output Protection Circuitry	Protected against output short-circuit and false pulse on power up. Latching short-circuit protection; reset by cycling power	
Delay at Power-up	100 milliseconds max. dc, 300 milliseconds max. ac; outputs do not conduct during this time	
Repeatability	1.5 milliseconds	
Output Response Time	<b>Opposed mode:</b> 16.6 milliseconds (1 cycle at 60 Hz) <b>All other modes:</b> 8.3 milliseconds (½ cycle at 60 Hz)	
Adjustments	<b>Diffuse, Retroreflective and Polarized Retroreflective models only:</b> 1-turn potentiometer Sensitivity (Gain) adjustment	
Indicators	<b>Green:</b> Power ON <b>Yellow:</b> Light Sensed	
Construction	<b>Housing:</b> ABS <b>Lenses:</b> PMMA <b>Gain Adjuster:</b> Acetal	
Environmental Rating	IEC IP67 (NEMA 6); 1200 PSI washdown NEMA ICS5, Annex F-2002 (PW12); UL Type 1	
Connections	2 m 3-conductor, 22 AWG PVC cable (300 V ac), or 150 mm pigtail PVC cable with 4-pin threaded Micro-style connector; <b>C1 suffix models:</b> 2 m 3-conductor, 22 AWG PVC cable (600 V ac)	
Operating Conditions	<b>Temperature:</b> <b>Less than 140 V ac/dc:</b> -25° to +70° C (N-MOSFET and P-MOSFET models) <b>140 V ac/dc or greater:</b> -25° to +55° C (N-MOSFET models only) <b>Max. Relative Humidity:</b> 95% @ 55° C (non-condensing)	
Certifications		

# QS30 Series

## High-Performance, Long-Range Sensors



- Right-angle, barrel- and side-mount sensors
- Specialized models for reliable detection of water or liquids containing water
- Specialized photoelectric sensors that have the ability to differentiate colors in low contrast applications
- Cordsets and brackets see page 62



**QS30**

page 56

Eight sensing modes for solving most applications: opposed, retroreflective, convergent, diffuse, plastic and glass fiber optic, and adjustable-field and fixed-field. High-performance sensing with visible, long-range Class 1 and 2 lasers with narrow effective beam for small object detection and precise position control.



**QS30 Water Detection**

page 58

The QS30 Water Sensors have an infrared wavelength that is tuned to the absorption band of water.



**QS30 Expert™**

page 59

Single push-button programming with five advanced sensing options for reliable detection of reflective objects.



**QS30 Adjustable-Field** page 60

Background suppression models for detection of objects when the background condition is not fixed, and foreground suppression models for detection when background is fixed and object varies in color or shape.



**QS30 Universal Voltage** page 61

Compact ac or dc powered sensor can be used in almost any mounting configuration, including 18 mm barrel, base or side mounting.

# QS30

## DC-Operated Long-Range Sensors



- The QS30 DC sensor is a specialized photoelectric sensor that has high performance and long range with a consistent voltage source.
- Ability to work reliably in low contrast applications
- Ability to detect liquid in translucent and opaque bottles
- Rated to IP67 for use in harsh environments
- Cordsets and brackets see page 62

### Opposed QS30

Infrared LED

Sensing Mode	Range	Connection	Output Type	Model
 OPPOSED	60 m	2 m	—	QS30E Emitter*
		5-pin Euro QD		QS30EQ Emitter*
 HIGH-POWERED OPPOSED	213 m	2 m	Bipolar NPN/PNP	QS30R
		5-pin Euro QD		QS30RQ
		2 m	—	QS30EX Emitter
		5-pin Euro QD		QS30EXQ Emitter
2 m	Bipolar NPN/PNP LO	QS30ARX		
5-pin Euro QD		QS30ARXQ		
 OPPOSED	2 m	5-pin Euro QD	Bipolar NPN/PNP DO	QS30RRX
				5-pin Euro QD



### Case Entry Detection Using Polar Retroreflective Sensors

The QS30LP verifies that there is a box present to be picked up before being sent to the palletizer. Shrink wrap is placed around the boxes on the pallet before being shipped.

### Retro & Polar Retro QS30

Visible Red LED

Sensing Mode	Range	Connection	Output Type	Model
 RETRO	12 m†	2 m	Bipolar NPN/PNP	QS30LV
		5-pin Euro QD		QS30LVQ
 POLAR RETRO	8 m†	2 m	Bipolar NPN/PNP	QS30LP
		5-pin Euro QD		QS30LPQ

For more specifications see page 63.

Connection options: A model with a QD requires a mating cordset (see page 62).

For 9 m cable, add suffix W/30 to the 2 m model number (example, QS30R W/30).

\* Standard emitters will only work with standard receivers.

† Retroreflective range is specified using one model BRT-84 retroreflector.

Diffuse QS30

 Infrared LED

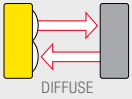
Sensing Mode	Range	Connection	Output Type	Model
	1 m	2 m	Bipolar NPN/PNP	QS30D
		5-pin Euro QD		QS30DQ

Fixed-Field QS30

 Visible Red LED

Sensing Mode	Range	Connection	Output Type	Model
	200 mm Cutoff	2 m	Bipolar NPN/PNP	QS30FF200
		5-pin Euro QD		QS30FF200Q
	400 mm Cutoff	2 m	Bipolar NPN/PNP	QS30FF400
		5-pin Euro QD		QS30FF400Q
	600 mm Cutoff	2 m	Bipolar NPN/PNP	QS30FF600
		5-pin Euro QD		QS30FF600Q

For more specifications see page 63.

 Connection options: A model with a QD requires a mating cordset (see page 62).

For 9 m cable, add suffix W/30 to the 2 m model number (example, QS30D W/30).

\* Super High-Power emitters will only work with Super High-Power receivers.

† Sensors can be used at ranges greater than listed for applications that require less excess gain. Please consult the factory for assistance on your long-range applications. Actual sensing range may differ, depending on the efficiency and reflective area of the retroreflector used. See Accessories for more information.



# QS30 Water Detection

## DC-Operated Long-Range Sensors



- Ability to work reliably in low contrast applications
- Ability to detect liquid in translucent and opaque bottles
- Cordsets and brackets see page 62

### Opposed Water Detection QS30

Infrared LED

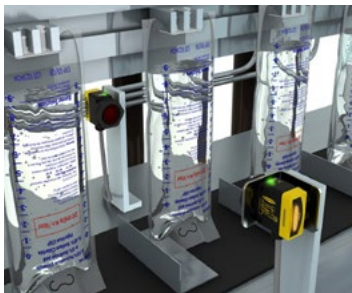

#### Detection of Clear Liquids in Transparent Packaging

The QS30H2O effectively and accurately detects the presence or absence of water inside clear IV bags.

Sensing Mode	Range	Connection	Output Type	Model
<p>OPPOSED WATER DETECTION</p>	4 m†	2 m	—	QS30EXH2O Emitter*
		5-pin Euro Pigtail QD	—	QS30EXH2OQ5 Emitter*
		2 m	Bipolar NPN/PNP	QS30ARXH2O
		5-pin Euro Pigtail QD	LO	QS30ARXH2OQ5
		2 m	Bipolar NPN/PNP	QS30RRXH2O
		5-pin Euro Pigtail QD	DO	QS30RRXH2OQ5
<p>OPPOSED WATER DETECTION</p>	2 m†	2 m	Bipolar NPN/PNP	QS30ARH2O
		5-pin Euro Pigtail QD	LO	QS30ARH2OQ5
		2 m	Bipolar NPN/PNP	QS30RRH2O
		5-pin Euro Pigtail QD	DO	QS30RRH2OQ5
<p>SUPER HIGH-POWER OPPOSED WATER DETECTION</p>	8 m†	2 m	—	QS30EXSH2O Emitter*
		5-pin Euro Pigtail QD	—	QS30EXSH2OQ5 Emitter*
		2 m	Bipolar NPN/PNP	QS30ARXSH2O
		5-pin Euro Pigtail QD	LO	QS30ARXSH2OQ5
		2 m	Bipolar NPN/PNP	QS30RRXSH2O
5-pin Euro Pigtail QD	DO	QS30RRXSH2OQ5		

For more specifications see page 63.

Connection options: A model with a QD requires a mating cordset (see page 62).

For 9 m cable, add suffix W/30 to the 2 m model number (example, QS30D W/30).

\* Super High-Power emitters will only work with Super High-Power receivers.

† Sensors can be used at ranges greater than listed for applications that require less excess gain. Please consult the factory for assistance on your long-range applications. Actual sensing range may differ, depending on the efficiency and reflective area of the retroreflector used. See Accessories for more information.

# QS30 Expert™

## DC-Operation with Push-Button Programming



- The QS30 Expert™ has high-performance sensing for challenging applications and is easy to align with an 8-segment LED bargraph.
- Available in laser retroreflective, diffuse, laser diffuse and retroreflective sensing modes
- Visible red LED or laser for easy alignment
- Models available for small object detection and precision control
- Cordsets and brackets see page 62

### Diffuse QS30 Expert™

➔ Visible Red LED    ✨ Visible Red Laser

Sensing Mode	Laser Class	Range	Connection	Model
DIFFUSE	—	High-Speed: 1100 mm Normal: 1400 mm	2 m 5-pin Euro QD	QS30EDV QS30EDVQ
DIFFUSE LASER	Class 1	400 mm	2 m 5-pin Euro QD	QS30LD QS30LDQ
DIFFUSE LASER	Class 2	800 mm	2 m 5-pin Euro QD	QS30LDL QS30LDLQ

### TEACH Mode

Sensors can be configured via any of five TEACH or SET options (by push button or the remote wire) to define the sensing limits. Sensing limit configuration options include:

- **Static TEACH:** one switching threshold, determined by two taught conditions
- **Dynamic (on-the-fly) TEACH:** one switching threshold, determined by multiple sampled conditions
- **Light SET and Dark SET:** one switching threshold, offset from a single sensing condition (the “dark” condition or the “light” condition)
- **Window SET:** a sensing window, centered around a single sensing condition

### Laser Retro & Polar Retro QS30 Expert™

➔ Visible Red LED    ✨ Visible Red Laser

Sensing Mode	Laser Class	Range	Connection	Model
LASER POLAR RETRO	Class 1	0.2-18 m†	2 m 5-pin Euro QD	QS30LLP QS30LLPQ
LASER POLAR RETRO	Class 1 (low contrast)	0.2-18 m†	2 m 5-pin Euro QD	QS30LLPC QS30LLPCQ
CLEAR OBJECT RETRO	—	100 mm to 2 m††	2 m 5-pin Euro QD	QS30ELVC QS30ELVCQ

For more specifications see page 64.

➔ Connection options: A model with a QD requires a mating cordset (see page 62).  
For 9 m cable, add suffix W/30 to the 2 m model number (example, QS30EDV W/30).

# QS30 Adjustable-Field

## Background and Foreground Suppression



- Foreground suppression models for detection when background is fixed and the object varies in color or shape
- Background suppression models for detection of objects when the background condition is not fixed
- Fluorescent light and crosstalk avoidance for reliable sensing
- Long range for reliable sensing up to 600 mm
- Cordsets and brackets see page 62

### Adjustable-Field Foreground Suppression

- Foreground suppression models for reliable detection when a fixed background is present and the object color or shape varies
- Objects detected to the face of the sensor (no dead zone)
- Simple multiturn screw adjustment of the cutoff distance
- Enhanced immunity to fluorescent lights
- Crosstalk immunity algorithm allows two sensors to be used in close proximity
- Visible red emitter

### Adjustable-Field Background Suppression

- Background suppression models detect objects of various color, and ignores objects beyond their cutoff range
- Simple multiturn screw adjustment of the cutoff distance
- Enhanced immunity to fluorescent lights
- Crosstalk immunity algorithm allows two sensors to be used in close proximity
- Visible red emitter

### Foreground Suppression QS30

Sensing Mode	Range	Connection	Output Type	Model
	Adjustable between 50-400 mm	2 m	Bipolar NPN/PNP	QS30AFF400
		5-pin Euro QD		QS30AFF400Q

### Background Suppression QS30 Adjustable-Field

Sensing Mode	Range	Connection	Output Type	Model
	Adjustable between 50-300 mm	2 m	Bipolar NPN/PNP	QS30AF
		5-pin Euro QD		QS30AFQ
	Adjustable between 50-600 mm	2 m	Bipolar NPN/PNP	QS30AF600
		5-pin Euro QD		QS30AF600Q

For more specifications see page 65.

Connection options: A model with a QD requires a mating cordset (see page 62).

For 9 m cable, add suffix W/30 to the 2 m model number (example, QS30AFF400 W/30).

# QS30 Universal Voltage

## Versatile Sensors Operate on AC or DC Voltage



- The QS30 Universal Sensor is a versatile, specialized sensor for use in many environments regardless of supply voltage
- Right-angle, barrel- and side-mount sensors
- Cordsets and brackets see page 62

### Opposed QS30, 12-250 V DC or 24-250 V AC

Infrared LED

Sensing Mode	Range	Connection	Output Type	Model
 OPPOSED	60 m	2 m	—	QS303E Emitter
		2 m	SPDT e/m Relay	QS30VR3R

### Polar Retro QS30, 12-250 V DC or 24-250 V AC

Visible Red LED

Sensing Mode	Range	Connection	Output Type	Model
 POLAR RETRO	8 m <sup>†</sup>	2 m	SPDT e/m Relay	QS30VR3LP

### Fixed-Field QS30, 12-250 V DC or 24-250 V AC

Visible Red LED

Sensing Mode	Range	Connection	Output Type	Model
 FIXED-FIELD	200 mm Cutoff	2 m	SPDT e/m Relay	QS30VR3FF200
	400 mm Cutoff	2 m	SPDT e/m Relay	QS30VR3FF400
	600 mm Cutoff	2 m	SPDT e/m Relay	QS30VR3FF600

For more specifications see page 64.

Connection options: A model with a QD requires a mating cordset (see page 62).

For 9 m cable, add suffix W/30 to the 2 m model number (example, QS303E W/30).

QD models: Available with modified specification, contact factory at 1-888-373-6767.

<sup>†</sup> Retroreflective range is specified using one model BRT-84 retroreflector.

Actual sensing range may differ, depending on the efficiency and reflective area of the retroreflector used. See Accessories for more information.

**Euro QD  
(for Q models)**  
Straight connector models listed; for right-angle, add **RA** to the end of the model number (example, **MQDC-506RA**)



**5-Pin**  
**MQDC1-506**  
2 m (6.5')  
**MQDC1-515**  
5 m (15')  
**MQDC1-530**  
9 m (30')

**Reflectors**



*Additional information is available  
See page 790*

**Apertures**



*Additional information is available  
See page 816*

*Additional cordset information is available  
See page 758*



**SMBQS30L**



**SMBQS30Y**



**SMBQS30YL**



**SMB30A**

*Additional bracket information is available  
See page 722*



Opposed, Retroreflective, Diffuse, Fixed-Field and Expert Models  
Suffix E, R, LP, LV, D, AF, FF, LLP, LLPC, LVC, EDV, LD and LDL



Opposed High-Power Models  
Suffix EX and RX



Adjustable-Field, Fixed-Field and Universal Voltage Models  
Suffix AFF, FF, R, E, LP





## QS30 Specifications

Supply Voltage and Current	<b>Emitters (High-Power):</b> 10 to 30 V dc (10% max. ripple) at less than 70 mA <b>Receivers (High-Power):</b> 10 to 30 V dc (10% max. ripple) at less than 22 mA <b>Analog Receivers (water):</b> 15 to 30 V dc (10% max. ripple) at less than 65 mA <b>All others:</b> 10 to 30 V dc (10% max. ripple) at 40 mA, (exclusive of load)	<b>Emitters (Water):</b> 10 to 30 V dc (10% max. ripple) at less than 80 mA <b>Receivers (Water):</b> 10 to 30 V dc (10% max. ripple) at less than 65 mA (exclusive of load)
Supply Protection Circuitry	Protected against reverse polarity and transient voltages	
Output Configuration	<b>Bipolar:</b> One PNP (current sourcing) and one NPN (current sinking); Light Operate (LO) or Dark Operate (DO) selectable or configurable (depending on model)	
Output Response Time	<b>Opposed:</b> 5 milliseconds ON/OFF <b>Opposed (High-Power):</b> 30 milliseconds ON/OFF <b>Opposed (Water): 10 x excess gain or more– Standard:</b> 1 millisecond ON/OFF <b>2x to 10x excess gain– Standard:</b> 3 milliseconds ON/OFF <b>All others:</b> 2 milliseconds ON/OFF	<b>Super High-Power:</b> 10 milliseconds ON/OFF <b>Super High-Power:</b> 30 milliseconds ON/OFF
Delay at Power-Up	100 milliseconds; outputs do not conduct during this time (except Opposed High-Powered and Water)	
Repeatability	<b>Opposed:</b> not applicable <b>Opposed (High-Power):</b> 5 milliseconds <b>Opposed (Water): 10 x excess gain or more– Standard:</b> 500 microseconds <b>2x to 10x excess gain– Standard:</b> 2.5 milliseconds <b>All others:</b> 500 microseconds	<b>Super High-Power:</b> 5 milliseconds <b>Super High-Power:</b> 25 milliseconds
Adjustments	<b>Opposed (High-Power and Water):</b> Light Operate/Dark Operate–dependent on model selected <b>Frequency via gray wire: A:</b> Gray (+) <b>B:</b> Gray (-) <b>Emitter only:</b> LED inhibit, via white wire White (-) turns emitter LED OFF (to allow verification of sensor operation) <b>Opposed, Retroreflective, and Polarized Retroreflective:</b> Selectable Light/Dark Operate is achieved via the gray wire <b>Light Operate:</b> Low (0 to 3 V)* <b>Dark Operate:</b> High (open or 5 to 30 V)* <b>Diffuse:</b> Selectable Light/Dark Operate is achieved via the gray wire <b>Light Operate:</b> High (open or 5 to 30 V)* <b>Dark Operate:</b> Low (0 to 3 V)* <b>Diffuse, Retroreflective, and Polarized Retroreflective (only):</b> Single-turn sensitivity (Gain) adjustment potentiometer  * Input impedance 10 kΩ See datasheet for more detailed information	
Indicators	<b>Opposed (High-Power):</b> 4-LED Signal Strength light bar <b>Green LED:</b> Power ON <b>Frequency indicator:</b> (A or B) <b>Receiver only: Yellow LED:</b> Output conducting  <b>All others (except emitters):</b> Large, oval LED indicator on sensor back <b>Yellow:</b> Output conducting Small indicator on back (adjustable-field only) <b>Blue/Red:</b> End of travel (EOT) LED 2 indicators on top <b>Green:</b> Power ON <b>Yellow:</b> Light sensed	
Construction	ABS plastic housing; acrylic lens cover <b>Opposed High-Power Lenses:</b> Impact resistant lens material	
Environmental Rating	<b>Opposed (High-Power): Cabled:</b> IP67; NEMA 6P <b>Opposed (High-Power) QD:</b> IP69K per DIN 40050-9 <b>Opposed (Water):</b> IEC IP67 (nema 6); PW12 1200 PSI washdown per NEMA PW12 <b>All others:</b> IP67; NEMA 6	
Connections	5-conductor 2 m or 9 m PVC cable, or 5-pin 150 mm pigtail or integral Euro-style quick-disconnect fitting, depending on model. QD cordsets are ordered separately. See page 62.	
Operating Conditions	<b>Opposed (Water), Opposed (High-Power):</b> -20° to +60° C <b>All others:</b> -20° to +70° C	<b>Relative humidity:</b> 90% (non-condensing) <b>Relative humidity:</b> 90% (non-condensing)
Certifications		

QS30 *Expert*<sup>™</sup> Specifications

Supply Voltage and Current	<b>Diffuse LED and Retroreflective LED:</b> 10 to 30 V dc (10% max. ripple) at less than 25 mA, exclusive of load <b>Diffuse Laser and Retroreflective Laser:</b> 10 to 30 V dc (10% max. ripple @ 10% duty cycle) @ 35 mA max current, exclusive of load
Output Protection Circuitry	Protected against output short-circuit, continuous overload, transient over-voltages and false pulse on power-up
Sensing Beam	<b>LED models:</b> 660 nm visible Red <b>Laser models: Class 1:</b> 650 nm visible Red <b>Class 2:</b> 658 nm visible Red
Beam Size at Aperture	<b>Diffuse Laser:</b> Approx. 2 mm <b>Retroreflective Laser:</b> Approx. 3 mm
Output Configuration	<b>Bipolar:</b> One NPN (current sinking) and one PNP (current sourcing); Light Operate (LO) or Dark Operate (DO) configurable
Output Response Time	<b>Diffuse LED: High-speed mode:</b> 300 microseconds <b>Normal mode:</b> 1.8 milliseconds <b>Diffuse Laser, Retroreflective Laser and Retroreflective LED:</b> 500 microseconds
Delay at Power-up	<b>Diffuse LED and Retroreflective LED:</b> 250 milliseconds; outputs do not conduct during this time <b>Diffuse Laser and Retroreflective Laser:</b> 1 second max.; outputs do not conduct during this time
Repeatability	<b>Diffuse LED: High-speed mode:</b> 100 microseconds <b>Normal mode:</b> 150 microseconds <b>Retroreflective LED:</b> 150 microseconds <b>Diffuse Laser and Retroreflective Laser:</b> 70 microseconds
Adjustments	2 push buttons and remote wire for TEACH programming and configuration See datasheet for detailed information
Indicators	<b>2 LEDs: Green:</b> Power ON <b>Yellow:</b> Output conducting See datasheets for more detailed information
Construction	PC/ABS housing with acrylic lens cover
Environmental Rating	<b>Retroreflective LED:</b> IEC IP67 (NEMA 6); PW12 1200 PSI washdown <b>All others:</b> IP67; NEMA 6
Connections	5-conductor 2 m or 9 m attached PVC cable, or 5-pin Euro-style quick-disconnect fitting. QD cordset are ordered separately. See page 62.
Operating Conditions	<b>Diffuse LED and Retroreflective LED:</b> <b>Temperature:</b> -10° to +55° C <b>Relative humidity:</b> 95% @ 55° C (non-condensing) <b>Diffuse Laser and Retroreflective Laser:</b> <b>Temperature:</b> -10° to +50° C <b>Relative humidity:</b> 95% @ 50° C (non-condensing)
Application Note	<b>QS30ELVC models:</b> If supply voltage is > 24 V dc, derate maximum output current 1 mA/°C above 25°C
Certification	

## QS30 Universal Voltage Specifications

Supply Voltage	24 to 250 V ac, 50/60 Hz or 12 to 250 V dc (1.0 watt max.)
Supply Protection Circuitry	Protected against transient voltages
Output Configuration	SPDT (Single-Pole Double-Throw) electromechanical relay output (all models except emitters)
Output Response Time	15 milliseconds ON/OFF
Delay at Power-Up	100 millisecond delay; output does not conduct during this time
Indicators	<b>2 LED indicators on sensor top:</b> <b>Green:</b> Power ON <b>Yellow:</b> Light sensed  <b>Large, oval LED indicator on sensor back (except emitters):</b> <b>Yellow:</b> Output conducting See datasheet for detailed information
Construction	ABS housing; acrylic lens cover
Environmental Rating	IEC IP67; NEMA 6
Connections	2 m or 9 m 5-wire PVC cable
Operating Conditions	<b>Temperature:</b> -20° to +70° C <b>Relative humidity:</b> 95% @ 50° C (non-condensing)
Certifications	 

## QS30 Adjustable-Field Specifications

Supply Voltage	10 to 30 V dc (10% max. ripple); current consumption: <b>AF600 &amp; AFF400 models:</b> Less than 80 mA at 10 V dc, less than 40 mA at 30 V dc <b>AF models:</b> 45 mA max current
Supply Protection Circuitry	Protected against reverse polarity and transient voltages
Delay at Power-Up	<b>AF600 &amp; AFF400 models:</b> 200 milliseconds; outputs do not conduct during this time <b>AF models:</b> 250 milliseconds; outputs do not conduct during this time
Output Configuration	<b>Bipolar:</b> One PNP (current sourcing) and one NPN (current sinking)
Output Rating	<b>AF600 &amp; AFF400 models:</b> 100 mA total output current (derate 1 mA per °C above 30° C) <b>OFF-state leakage current:</b> less than 5 µA @ 30 V dc <b>ON-state saturation voltage:</b> <b>NPN:</b> less than 1.5 V @ 100 mA <b>PNP:</b> less than 2.0 V @ 100 mA <b>AF models:</b> 150 mA total output current (derate 1 mA per °C above 25° C) <b>OFF-state leakage current:</b> less than 50 µA @ 30 V dc <b>ON-state saturation voltage:</b> <b>NPN:</b> less than 200 mV @ 10 mA; less than 1 V @ 150 mA <b>PNP:</b> less than 1.25 V @ 10 mA; less than 2 V @ 150 mA
Output Protection	Protected against false pulse on power-up and continuous overload or short circuit of outputs
Output Response Time	<b>AF600 &amp; AFF400 models:</b> 5 milliseconds ON/OFF <b>AF models:</b> 1 millisecond ON/OFF
Repeatability	<b>AF600 &amp; AFF400 models:</b> 750 microseconds <b>AF models:</b> 170 microseconds
Adjustments	<b>AF600 &amp; AFF400 models:</b> Four-turn adjustment screw sets cutoff distance between min. and max. positions, clutched at both ends of travel <b>AF models:</b> 2 push buttons and remote wire <ul style="list-style-type: none"> <li>• Easy push-button configuration</li> <li>• Manually adjust (+/-) cutoff (push buttons only)</li> <li>• N.O./N.C. and OFF-delay configuration options (push buttons only)</li> <li>• Push-button lockout (from remote wire only)</li> </ul> 2 push buttons or LO/DO adjustment
Indicators	<b>AF600 &amp; AFF400 models:</b> Large, oval LED indicator on sensor back <b>Yellow:</b> Output conducting Small indicator on back <b>Blue/Red:</b> End of travel (EOT) LED 2 indicators on top <b>Green:</b> Power ON <b>Yellow:</b> Light sensed <b>AF models:</b> <b>8-segment red bargraph:</b> Distance relative to cutoff point <b>Green LED:</b> Power ON <b>Yellow LED:</b> Output conducting
Construction	ABS plastic housing; acrylic lens cover
Environmental Rating	IEC IP67; NEMA 6
Connections	5-conductor 2 m or 9 m PVC cable, or 5-pin 150 mm pigtail or integral Euro-style quick-disconnect fitting, depending on model. QD cordsets are ordered separately. See page 62.
Operating Conditions	<b>AF600 &amp; AFF400 models:</b> -20° to +60° C; 95% relative humidity @ 50° C (non-condensing) <b>AF models:</b> -10° to +55° C; 90% relative humidity @ 55° C (non-condensing)
Vibration and Mechanical Shock	All models meet Mil. Std. 202F requirements. Method 201A (Vibration: 10 to 60 Hz max. double amplitude 0.06", max. acceleration 10G). Also meets IEC 947-5-2 requirements: 30G, 11 milliseconds duration, half sine wave.
Certifications	

# Q12 Series

## Miniature Self-Contained Sensors



- The Q12 sensor is a small sensor with high performance for powerful sensing in confined spaces.
- Overmolded housing
- Short-range background suppression
- Cordsets and brackets see page 68

### Opposed Q12



Sensing Mode	Range	Connection	Output	Models LO*	Models DO*
 OPPOSED	2 m	2 m	–	Q126E Emitter	
		4-Pin Pico Pigtail QD	–	Q126EQ Emitter	
		3-Pin Pico Pigtail QD	–	Q126EQ3 Emitter	
 OPPOSED	2 m	2 m	Bipolar NPN/PNP	Q12AB6R	Q12RB6R
		4-Pin Pico Pigtail QD	Bipolar NPN/PNP	Q12AB6RQ	Q12RB6RQ
		3-Pin Pico Pigtail QD	PNP	Q12AP6RQ3	Q12RP6RQ3
		3-Pin Pico Pigtail QD	NPN	Q12AN6RQ3	Q12RN6RQ3

### Retro & Polar Retro Q12



Sensing Mode	Range	Connection	Output	Models LO*	Models DO*
 RETRO	1.5 m <sup>†</sup>	2 m	Bipolar NPN/PNP	Q12AB6LV	Q12RB6LV
		4-Pin Pico Pigtail QD	Bipolar NPN/PNP	Q12AB6LVQ	Q12RB6LVQ
		3-Pin Pico Pigtail QD	PNP	Q12AP6LVQ3	Q12RP6LVQ3
		3-Pin Pico Pigtail QD	NPN	Q12AN6LVQ3	Q12RN6LVQ3
 POLAR RETRO	1 m <sup>†</sup>	2 m	Bipolar NPN/PNP	Q12AB6LP	Q12RB6LP
		4-Pin Pico Pigtail QD	Bipolar NPN/PNP	Q12AB6LPQ	Q12RB6LPQ
		3-Pin Pico Pigtail QD	PNP	Q12AP6LPQ3	Q12RP6LPQ3
		3-Pin Pico Pigtail QD	NPN	Q12AN6LPQ3	Q12RN6LPQ3

For more specifications see page 69.

**Connection options:**

**Bipolar Models Only:** For 9 m cable, add suffix W/30 to the 2 m model number (example, Q126E W/30).

**QD models:** A model with a QD requires a mating cordset (see page 68).

For 4-pin 150 mm Euro-style QD, add suffix Q5 (example, Q126EQ5).

\* For black housing, add prefix D to the model number, for example, DQ12AB6R

† Retroreflective range is specified using a BRT-60X40C retroreflector.

Actual sensing range may differ, depending on the efficiency and reflective area of the retroreflector used. See Accessories for more information.

Fixed-Field Q12

➔ Visible Red LED

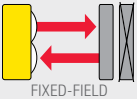
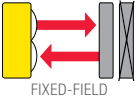
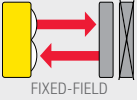
Sensing Mode	Range	Connection	Output	Models LO*	Models DO*
 <p>FIXED-FIELD</p>	15 mm Cutoff	2 m	Bipolar NPN/PNP	Q12AB6FF15	Q12RB6FF15
		4-Pin Pico Pigtail QD	Bipolar NPN/PNP	Q12AB6FF15Q	Q12RB6FF15Q
		3-Pin Pico Pigtail QD	PNP	Q12AP6FF15Q3	Q12RP6FF15Q3
		3-Pin Pico Pigtail QD	NPN	Q12AN6FF15Q3	Q12RN6FF15Q3
 <p>FIXED-FIELD</p>	30 mm Cutoff	2 m	Bipolar NPN/PNP	Q12AB6FF30	Q12RB6FF30
		4-Pin Pico Pigtail QD	Bipolar NPN/PNP	Q12AB6FF30Q	Q12RB6FF30Q
		3-Pin Pico Pigtail QD	PNP	Q12AP6FF30Q3	Q12RP6FF30Q3
		3-Pin Pico Pigtail QD	NPN	Q12AN6FF30Q3	Q12RN6FF30Q3
 <p>FIXED-FIELD</p>	50 mm Cutoff	2 m	Bipolar NPN/PNP	Q12AB6FF50	Q12RB6FF50
		4-Pin Pico Pigtail QD	Bipolar NPN/PNP	Q12AB6FF50Q	Q12RB6FF50Q
		3-Pin Pico Pigtail QD	PNP	Q12AP6FF50Q3	Q12RP6FF50Q3
		3-Pin Pico Pigtail QD	NPN	Q12AN6FF50Q3	Q12RN6FF50Q3

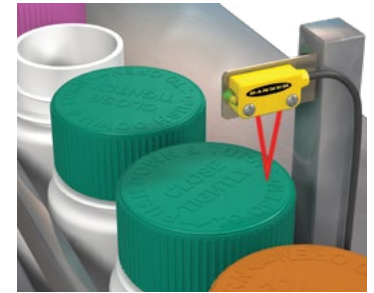

**Bottle Cap Detection Using Fixed-Field Sensors**

As bottle caps pass below the fixed-field beam identifies bottle caps regardless of color and rejects bottles missing caps.

PFA-Jacketed Q12

➔ Visible Red LED

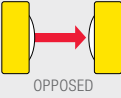
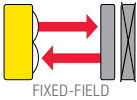
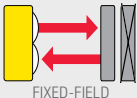
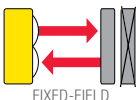
Sensing Mode	Range	Connection	Output	Models LO	Models DO
 <p>OPPOSED</p>	1.5 m	2 m	Bipolar NPN/PNP	Q12AB6RCR	Q12RB6RCR
 <p>FIXED-FIELD</p>	12 mm Cutoff	2 m	Bipolar NPN/PNP	Q12AB6FF15CR	Q12RB6FF15CR
 <p>FIXED-FIELD</p>	28 mm Cutoff	2 m	Bipolar NPN/PNP	Q12AB6FF30CR	Q12RB6FF30CR
 <p>FIXED-FIELD</p>	48 mm Cutoff	2 m	Bipolar NPN/PNP	Q12AB6FF50CR	Q12RB6FF50CR

For more specifications see page 69.

**Connection options:**

**Bipolar Models Only:** For 9 m cable, add suffix W/30 to the 2 m model number (example, Q12RB6FF15 W/30).  
**QD models:** A model with a QD requires a mating cordset (see page 68).  
 For 4-pin 150 mm Euro-style QD, add suffix Q5 (example, Q12RB6FF15Q5).

\* For black housing, add prefix D to the model number, for example, DQ12AB6R  
 Actual sensing range may differ, depending on the efficiency and reflective area of the retroreflector used. See Accessories for more information.





**Euro QD (for Q5 models)**  
Straight connector models listed; for right-angle, add **RA** to the end of the model number (example, **MQDC-406RA**)

**4-Pin**  
**MQDC-406**  
2 m (6')  
**MQDC-415**  
5 m (15')  
**MQDC-430**  
9 m (30')



**Pico QD (for Q and Q3 models)**  
Straight connector models listed; for right-angle, **W** replaces **G** in the model number. (example, **PKW4M-2**)

<b>3-Pin</b>	<b>4-Pin</b>
<b>PKG3M-2</b> 2 m (6.5')	<b>PKG4M-2</b> 2 m (6.5')
<b>PKG3M-5</b> 5 m (15')	<b>PKG4M-5</b> 5 m (15')
<b>PKG3M-7</b> 7 m (23')	-
<b>PKG3M-9</b> 9 m (30')	<b>PKG4M-9</b> 9 m (30')
<b>PKG3M-10</b> 10 m (32')	-

Additional cordset information is available  
See page 758



SMBQ12T



SMBQ12A

Additional bracket information is available  
See page 722

Reflectors



Additional information is available  
See page 790

Apertures



Additional information is available  
See page 816



Opposed, Retroreflective and Fixed-Field Models  
Suffix E, R, LV and FF

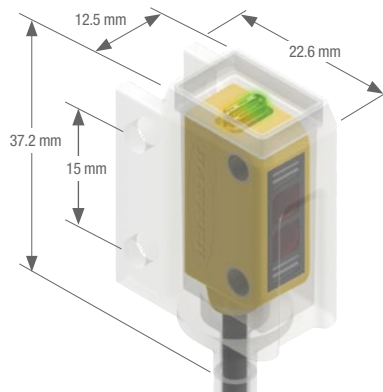

Chemical-Resistant Models  
Suffix CR

## Q12 Specifications

Sensing Beam	640 nm visible red
Supply Voltage and Current	10 to 30 V dc (10% max. ripple) @ 20 mA max. current
Supply Protection Circuitry	Protected against reverse polarity and transient voltages
Output Configuration	<b>Bipolar:</b> 1 NPN (current sinking) and 1 PNP (current sourcing); Light Operate (LO) or Dark Operate (DO), depending on model <b>Single-output:</b> 1 NPN or 1 PNP; Light Operate (LO) or Dark Operate (DO), depending on model
Output Rating	50 mA total across both outputs with overload and short circuit protection <b>OFF-state leakage current:</b> <b>ON-state saturation voltage:</b> NPN: 200 $\mu$ A                      NPN: 1.25 V @ 50 mA PNP: 10 $\mu$ A                         PNP: 1.45 V @ 50 mA
Output Protection Circuitry	Protected against false pulse on power-up; short-circuit protected
Output Response Time	<b>Opposed:</b> 1.3 milliseconds ON; 900 microseconds OFF <b>All others:</b> 700 microseconds ON/OFF
Delay at Power-up	120 milliseconds; outputs do not conduct during this time
Repeatability	175 microseconds
Switching Frequency	<b>Opposed models:</b> 385 Hz <b>All other models:</b> 715 Hz
Indicators	<b>2 LED indicators (Emitters-Green only):</b> Green — Power ON Yellow — Light sensed
Construction	<b>Polarized Retroreflective:</b> Thermoplastic elastomer housing with glass lens <b>Standard:</b> Thermoplastic elastomer housing with polycarbonate lens <b>Chemical-resistant:</b> Housing encased in PFA jacket; cable encased in 3/16" O.D. PFA tubing
Environmental Rating	<b>Standard:</b> IEC IP67 <b>Chemical-resistant:</b> IEC IP67 (NEMA 6) and PW12 1200 psi washdown per NEMA ICS 5, Annex F-2002
Connections	<b>Bipolar:</b> 2 m or 9 m attached PVC cable, or 150 mm pigtail with 4-pin Pico-style ( <b>Q</b> ) or 4-pin Euro-style ( <b>Q5</b> ) quick-disconnect fitting. QD cordsets are ordered separately. See page 68. <b>Single output:</b> 150 mm pigtail with 3-pin Pico-style ( <b>Q3</b> ) quick-disconnect fitting. QD cordsets are ordered separately. See page 68. <b>Chemical-resistant:</b> 2 m attached cable encased in 3/16" O.D. PFA tubing
Operating Conditions	<b>Temperature:</b> -20° to +55° C <b>Storage temperature:</b> -30° to +75° C <b>Relative humidity:</b> 95% max. @ 50° C (non-condensing)
Certifications	

# Q20 Series

## Industry Standard Global Housing



- The Q20 is a versatile sensor with a universal rectangular housing and multiple mounting options, making it ideal for global manufacturing
- Rated to 1200 psi for use in washdown environments
- Enhanced design for noise immunity and crosstalk avoidance
- Visible red beam for easy alignment on most models
- Cordsets and brackets see page 68

### Opposed Q20

⇨ Infrared LED    → Visible Red LED

Sensing Mode	Range	Connection	Models NPN*	Models PNP*
 OPPOSED	12 m	2 m	Q20E Emitter	
		4-pin Euro Pigtail QD	Q20EQ5 Emitter	
		2 m	Q20NR	Q20PR
		4-pin Euro Pigtail QD	Q20NRQ5	Q20PRQ5
 OPPOSED	20 m	2 m	Q20EL Emitter	
		4-pin Euro Pigtail QD	Q20ELQ5 Emitter	
		2 m	Q20NRL	Q20PRL
		4-pin Euro Pigtail QD	Q20NRLQ5	Q20PRLQ5



### Unfinished Can Detection Using Polar Retro Sensors

When the unfinished cans pass between the sensor and the retroreflector, the light reflected off the cans has a different polarization than the light returned by the retroreflector. As a result, the beam will be blocked by the cans and the output will be triggered.

### Retro & Polar Retro Q20

→ Visible Red LED

Sensing Mode	Range	Connection	Models NPN*	Models PNP*
 RETRO	6 m <sup>†</sup>	2 m	Q20NLV	Q20PLV
		4-pin Euro Pigtail QD	Q20NLVQ5	Q20PLVQ5
 POLAR RETRO	4 m <sup>†</sup>	2 m	Q20NLP	Q20PLP
		4-pin Euro Pigtail QD	Q20NLPQ5	Q20PLPQ5

For more specifications see page 73.

Connection options: A model with a QD requires a mating cordset (see page 72).

For 9 m cable, add suffix W/30 to the 2 m model number (example, Q20E W/30).

QD models:

- For a 4-pin 150 mm Pico-style pigtail QD, add suffix Q (example, Q20NDQ).
- For a 4-pin integral Pico-style QD, add suffix Q7 (example, Q20EQ7).

\* Available with health or alarm mode output; contact factory at 1-888-373-6767 for details.

<sup>†</sup> Retroreflective range is specified using one model BRT-84 retroreflector. Actual sensing range may differ, depending on the efficiency and reflective area of the retroreflector used. See Accessories section for more information.

Diffuse Q20

 Infrared LED  Visible Red LED

Sensing Mode	Range	Connection	Models NPN*	Models PNP*
 DIFFUSE	250 mm	2 m 4-pin Euro Pigtail QD	Q20ND Q20NDQ5	Q20PD Q20PDQ5
 DIFFUSE	800 mm	2 m 4-pin Euro Pigtail QD	Q20NDL Q20NDLQ5	Q20PDL Q20PDLQ5
 DIFFUSE	1500 mm	2 m 4-pin Euro Pigtail QD	Q20NDXL Q20NDXLQ5	Q20PDXL Q20PDXLQ5

Fixed-Field Q20

 Visible Red LED

Sensing Mode	Range	Connection	Models NPN*	Models PNP*
 FIXED-FIELD	0-50 mm Cutoff	2 m 4-pin Euro Pigtail QD	Q20NFF50 Q20NFF50Q5	Q20PFF50 Q20PFF50Q5
 FIXED-FIELD	0-100 mm Cutoff	2 m 4-pin Euro Pigtail QD	Q20NFF100 Q20NFF100Q5	Q20PFF100 Q20PFF100Q5
 FIXED-FIELD	0-150 mm Cutoff	2 m 4-pin Euro Pigtail QD	Q20NFF150 Q20NFF150Q5	Q20PFF150 Q20PFF150Q5

For more specifications see page 73.

 **Connection options:** A model with a QD requires a mating cordset (see page 72).

For 9 m cable, add suffix W/30 to the 2 m model number (example, Q20ND W/30).

**QD models:**

- For a 4-pin 150 mm Euro-style pigtail QD, add suffix Q5 (example, Q20NDQ5).
- For a 4-pin 150 mm Pico-style pigtail QD, add suffix Q (example, Q20NDQ).
- For a 4-pin integral Pico-style QD, add suffix Q7 (example, Q20NDQ7).

\* Available with health or alarm mode output; contact factory at 1-888-373-6767 for details.



4-Pin

**Euro QD (for Q5 models)**  
Straight connector models listed; for right-angle, add **RA** to the end of the model number (example, **MQDC-406RA**)

**MQDC-406**  
2 m (6')  
**MQDC-415**  
5 m (15')  
**MQDC-430**  
9 m (30')



4-Pin

**Pico QD (for Q models)**  
Straight connector models listed; for right-angle, **W** replaces **G** in the model number. (example, **PKG4M-2**)

**PKG4M-2**  
2 m (6')  
**PKG4M-5**  
5 m (15')  
**PKG4M-9**  
9 m (30')



4-Pin

**Pico QD (for Q7 models)**  
Straight snap-on connector model

**Pico QD (for Q7 models)**  
Right-angle snap-on connector model

**PKG4-2**  
2 m (6')  
**PKW4Z-2**  
2 m (6')

Additional cordset information is available  
See page 758



SMBQ20H



SMBQ20LV



SMBQ20L



SMBQ20U

Additional bracket information is available  
See page 722

Reflectors



Additional information is available  
See page 790

Apertures



Additional information is available  
See page 816



Opposed, Retroreflective,  
Fixed-Field and Diffuse Models  
Suffix E, EL, R, RL, LP, LV,  
D, DL, DXL and FF









## Q20 Specifications

Supply Voltage and Current	<b>Fixed-field:</b> 10 to 30 V dc (10% maximum ripple) at less than 25 mA, exclusive of load <b>All others:</b> 10 to 30 V dc (10% maximum ripple) at less than 18 mA, exclusive of load
Supply Protection Circuitry	Protected against reverse polarity and transient voltages
Output Configuration	Solid-state complementary; PNP (sourcing) or NPN (sinking), depending on model
Output Rating	100 mA with short circuit protection <b>OFF-state leakage current:</b> NPN: less than 200 $\mu$ A sinking PNP: less than 10 $\mu$ A sourcing <b>ON-state saturation voltage:</b> NPN: less than 1.6 V @ 100 mA PNP: less than 3.0 V @ 100 mA
Output Response Time	<b>Opposed:</b> 1 ms ON/600 ms OFF <b>Fixed-field:</b> 3 ms ON/1.5 ms OFF <b>All others:</b> 800 ms ON/OFF
Delay at Power-up	100 milliseconds; outputs do not conduct during this time
Repeatability	<b>Opposed:</b> 140 microseconds <b>Fixed-field:</b> 182 microseconds <b>All others:</b> 155 microseconds
Adjustments	<b>Diffuse, Retroreflective and Polarized Retroreflective:</b> single-turn sensitivity (Gain) adjustment potentiometer
Indicators	<b>Emitters:</b> Green power ON only <b>All others: Two LED Indicators: Green:</b> Power ON <b>Yellow:</b> Black (LO) wire conducting
Construction	<b>Housing:</b> ABS <b>Lenses:</b> PMMA <b>Gain Adjuster(retro and diffuse models only):</b> PBT
Connections	2 m or 9 m 4-wire PVC cable, 4-pin 150 mm pigtail Pico-style QD ( <b>Q</b> ), or 4-pin 150 mm pigtail Euro-style QD ( <b>Q5</b> ), or 4-pin integral Pico-style QD ( <b>Q7</b> ), depending on model. QD cordsets are ordered separately. See page 72.
Operating Conditions	<b>Temperature:</b> -20° to +60° C <b>Relative humidity:</b> 95% @ 50° C (non-condensing)
Environmental Rating	IEC IP67; NEMA 6
Vibration and Mechanical Shock	All models meet Mil. Std. 202F requirements method 201A (vibration: 10 to 60 Hz max., double amplitude 0.06", maximum acceleration 10G). Also meets IEC 947-5-2: 30G 11 ms duration, half sine wave
Application Note	1. Opposed mode sensor spacing can be reduced by alternating emitters and receivers or by applying crosstalk filters (visible red models only). 2. NPN OFF-state leakage current is < 200 $\mu$ A for load resistances > 3 k $\Omega$ or optically isolated loads. For load currents of 100 mA, leakage is < 1% of load current.
Certification	



## Rectangle

Rectangular sensors have a large rugged housing. The rectangle housing style offers side and barrel mounting options.

Series	Description	Max Sensing Range	Dimensions H x W x D	Protection Rating	Housing Material	Power Supply
	<b>MINI-BEAM®</b> Comprehensive sensor line with a series of LED colors, gain pots/TEACH modes and ac/dc models. Page 76	<b>Opposed:</b> 30 m <b>Clear Plastic:</b> 300 mm <b>Retro:</b> 5 m <b>Retro Polarized:</b> 3 m <b>Convergent:</b> 43 mm <b>Diffuse:</b> 380 mm <b>Glass/Plastic Fiber:</b> Varies	Varies by model	IP67	Thermoplastic Polyester	10 to 30 V dc 24 to 240 V ac 5 to 15 V dc
	<b>Q25</b> Completely epoxy-encapsulated for use in harsh sensing environments, including food and beverage applications. Page 78	<b>Opposed:</b> 20 m <b>Retro Polarized:</b> 2 m <b>Fixed-Field:</b> 100 mm	50.2 x 25 x 30 mm	IP67 NEMA 6	Thermoplastic Polyester	10 to 30 V dc 20 to 240 V ac
	<b>Q40</b> Completely epoxy-encapsulated long-range sensor available in ac or dc supply voltages. Page 80	<b>Opposed:</b> 60 m <b>Retro Polarized:</b> 6 m <b>Fixed-Field:</b> 600 mm	69.8 x 41 x 46 mm	<b>QD models:</b> IP69K <b>Other models:</b> IP67 NEMA 6P	Thermoplastic Polyester	10 to 30 V dc 20 to 245 V ac
	<b>Q45</b> Advanced one-piece, rugged sensor with outstanding optical performance. page 84	<b>Opposed:</b> 60 m <b>Retro:</b> 9 m <b>Polarized Retro:</b> 6 m <b>Laser Polarized Retro:</b> 40 m <b>Diffuse:</b> 3 m <b>Convergent:</b> 100 m	87.6 x 44.5 x 54.1 mm	IP67 NEMA 6P	Thermoplastic Polyester	10 to 30 V dc 90 to 250 V ac 24 to 250 V ac 12 to 250 V dc
	<b>Q60</b> Laser or LED sensor for low reflectivity targets, regardless of background. page 88	<b>Adjustable-Field:</b> 2 m <b>Laser Adjustable-Field:</b> 2 m	75 x 25 x 60 mm	IP67 NEMA 6	ABS	10 to 30 V dc 12 to 250 V dc 24 to 250 V ac
	<b>PicoDot®</b> The PicoDot® is a convergent-mode laser sensor with extreme precision. Page 92	<b>Laser Polarized Retro:</b> 10.6 m <b>Laser Convergent:</b> 305 mm	<b>PD45:</b> 40.6 x 45.6 x 12.7 mm <b>PD49:</b> 42.7 x 49.1 x 15.2 mm	<b>PD45:</b> IP54 <b>PD49:</b> IP67	ABS	10 to 30 V dc
	<b>QM42 &amp; QMT42</b> Universal housing design with 18 mm threaded lens; an ideal replacement for hundreds of other sensor styles. Page 94	<b>QM42</b> <b>Opposed:</b> 10 m <b>Retro Polarized:</b> 3 m <b>Diffuse:</b> 400 mm <b>Adjustable-Field:</b> 150 mm <b>Plastic Fiber:</b> Varies <b>QMT42</b> <b>Diffuse:</b> 6 m <b>Fixed-Field:</b> 2 m <b>Adjustable-Field:</b> 400 mm	<b>QM42:</b> 42 x 12.7 x 42 mm <b>QMT42:</b> 58 x 18 x 42 mm	IP67 NEMA 6	Die-cast Zinc Alloy	10 to 30 V dc

# MINI-BEAM® Series

## Complete Line of Industry Standard Sensors



- AC, DC or universal models available
- Infrared or visible red, green, blue or white sensing beam
- Industry standard mounting holes
- Easy push-button TEACH-mode setup available



**Euro-Style**  
Straight connector models listed;  
for right-angle, add **RA** to the end  
of the model number  
(example, **MQDC-406RA**)

4-Pin	5-Pin
<b>MQDC-406</b> 2 m (6.5')	<b>MQDC1-506</b> 2 m (6.5')
<b>MQDC-415</b> 5 m (15')	<b>MQDC1-515</b> 5 m (15')
<b>MQDC-430</b> 9 m (30')	<b>MQDC1-530</b> 9 m (30')



**Micro-Style**  
Straight connector models listed;  
for right-angle, add **RA** to the end  
of the model number  
(example, **MQDC-306RA**)

3-Pin
<b>MQDC-306</b> 2 m (6.5')
<b>MQDC-315</b> 5 m (15')
<b>MQDC-330</b> 9 m (30')



**NAMUR Euro-Style**  
Straight connector models listed;  
for right-angle, add **RA** to the end  
of the model number  
(example, **MQD9-406RA**)

4-Pin
<b>MQD9-406</b> 2 m (6.5')
<b>MQD9-415</b> 5 m (15')

Additional cordset information is available  
See page 758



SMB18A



SMB18FA..



SMB18SF



SMB312B



SMB3018SC

Additional bracket information is available  
See page 722

### Reflectors



Additional information is available  
See page 790

### Apertures



Additional information is available  
See page 816

MINI-BEAM® Specifications

Visit [Bannerengineering.com](http://Bannerengineering.com) for more information on this and other products

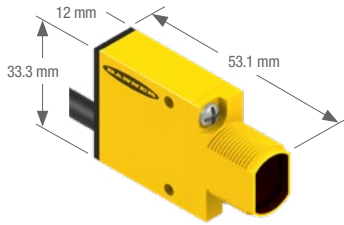

**MINI-BEAM DC**  
Opposed, Retroreflective,  
Diffuse and Convergent Models  
Suffix E, R, EPD, RPD, D, LV, LP, C, C2,  
CV, CV2, CVB, CV2B, CVG and CV2G



**MINI-BEAM DC**  
Diffuse Models  
Suffix DBZ and W



**MINI-BEAM DC**  
Glass Fiber Models  
Suffix F, FV, FVG and FVB



**MINI-BEAM DC**  
Plastic Fiber Models  
Suffix FP, FPG and FPB

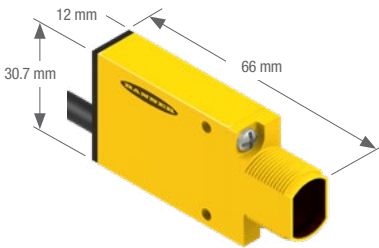

**MINI-BEAM AC & Expert**  
Opposed, Retroreflective,  
Diffuse and Convergent Models  
Suffix E, R, EPD, RPD, D, DV, LV, LP, C,  
CV, CV2, CVG, CVB and CVW

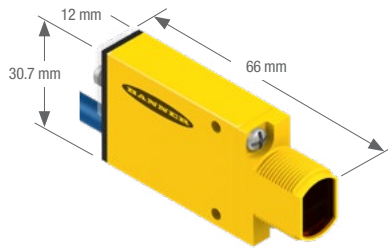

**MINI-BEAM NAMUR**  
Retroreflective, Diffuse, Opposed and  
Convergent Models  
Suffix E, R, LV, D and CV



**MINI-BEAM AC, Expert & NAMUR**  
Diffuse Models  
Suffix DBZ and W

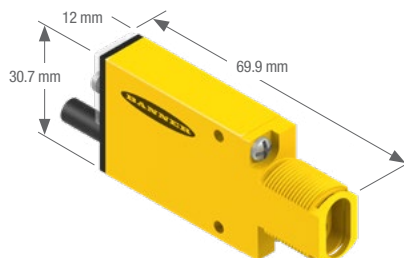

**MINI-BEAM AC, Expert & NAMUR**  
Glass Fiber Models  
Suffix F and FV



**MINI-BEAM AC, Expert & NAMUR**  
Plastic Fiber Models  
Suffix FP



# Q25 Series

## Right-Angle Base-Mount Rectangular Sensors



- Completely epoxy-encapsulated for use in harsh sensing environments
- Available in opposed, retroreflective and fixed-field modes
- Available in 10-30 V dc or 20-250 V ac
- Wide operating range from -40° to +70° C
- Models rated to IP67 and IP69K to withstand harsh washdown environments



**Euro-Style**  
Straight connector models listed; for right-angle, add **RA** to the end of the model number (example, **MQDC-406RA**)

**MQDC-406**  
2 m (6.5')  
**MQDC-415**  
5 m (15')  
**MQDC-430**  
9 m (30')



**Micro-Style**  
Straight connector models listed; for right-angle, add **RA** to the end of the model number (example, **MQDC-306RA**)

**MQAC-406**  
2 m (6.5')  
**MQAC-415**  
5 m (15')  
**MQAC-430**  
9 m (30')

*Additional cordset information is available  
See page 758*



SMB18A



SMB18FA..



SMB18SF

*Additional bracket information is available  
See page 722*



Q25 Opposed, Retroreflective and Fixed-Field Models  
Suffix E, R, LP, and FF

## Q25 DC Specifications

Supply Voltage and Current	10 to 30 V dc (10% max. ripple); Supply current (exclusive of load current): <b>Opposed Emitters:</b> 25 mA <b>Opposed Receivers:</b> 20 mA <b>Polarized Retroreflective:</b> 30 mA <b>Fixed-Field:</b> 35 mA
Output Configuration	Solid-state complementary dc switch; NPN (current sinking) or PNP (current sourcing), depending on model. The Dark Operate (DO) output may be wired as a normally open marginal signal alarm output, depending upon hookup to the power supply.
Output Rating	150 mA max. (each) in standard hookup. When wired for alarm output, the total load may not exceed 150 mA <b>OFF-state leakage current:</b> less than 1 µA at 30 V dc <b>ON-state saturation voltage:</b> less than 1 V at 10 mA dc; less than 1.5 V at 150 mA dc
Output Response Time	<b>Opposed:</b> 3 milliseconds ON, 1.5 milliseconds OFF <b>Polarized Retroreflective and Fixed-Field:</b> 3 milliseconds ON/OFF
Delay at Power-up	100 milliseconds; outputs do not conduct during this time
Repeatability	<b>Opposed:</b> 375 microseconds <b>Polarized Retroreflective and Fixed-Field:</b> 750 microseconds Repeatability and response are independent of signal strength
Indicators	<b>Two LEDs:</b> Green and Yellow <b>Green:</b> Power ON <b>Green Flashing:</b> output overload <b>Yellow:</b> Light Operate (LO) output energized <b>Yellow Flashing:</b> marginal gain
Construction	Housings are thermoplastic polyester. Lenses are polycarbonate or acrylic; one jam nut included.
Environmental Rating	Leakproof design rated NEMA 6P, IP67. QD models rated IP69K per DIN 40050-9.
Operating Conditions	<b>Temperature:</b> -40° to +70° C <b>Relative humidity:</b> 90% at 50° C (non-condensing)
Vibration and Mechanical Shock	All models meet Mil. Std. 202F requirements. Method 201A (Vibration; frequency 10 to 60 Hz, max., double amplitude 0.06-inch acceleration 10G). Method 213B conditions H&I (Shock: 75G with unit operating; 100G for non-operation)
Certifications	 ECOLAB® chemical compatibility pending on some models; contact Banner Engineering for details

## Q25 AC Specifications

Supply Voltage and Current	20 to 250 V ac (50/60 Hz) <b>Average current:</b> 20 mA <b>Peak current:</b> 200 mA at 20 V ac, 500 mA at 120 V ac, 750 mA at 250 V ac
Output Configuration	Solid-state ac switch; three-wire hookup; Choose Light Operate (LO) or Dark Operate (DO), depending on model <b>Light Operate:</b> Output conducts when the sensor sees its own (or the emitter's) modulated light <b>Dark Operate:</b> Output conducts when sensor sees dark
Output Rating	300 mA max. (continuous) Fixed-Field: derate 5 mA/° C above +50° C <b>Inrush capability:</b> 1 amp for 20 milliseconds, non-repetitive <b>OFF-state leakage current:</b> less than 100 µA <b>ON-state voltage drop:</b> 3 V at 300 mA ac; 2 V at 15 mA ac
Output Response Time	<b>Opposed:</b> 16 milliseconds ON, 8 milliseconds OFF <b>Polarized Retroreflective and Fixed-Field:</b> 16 milliseconds ON/OFF
Delay at Power-up	100 milliseconds
Repeatability	<b>Opposed:</b> 2 milliseconds; Polarized Retroreflective and Fixed-Field: 4 milliseconds Repeatability and response are independent of signal strength.
Indicators	<b>Two LEDs:</b> Green and Yellow <b>Solid Green:</b> Power ON <b>Solid Yellow:</b> Light sensed <b>Yellow Flashing:</b> marginal gain
Construction	Housings are thermoplastic polyester. Lenses are polycarbonate or acrylic; one jam nut included.
Environmental Rating	Leakproof design rated NEMA 6P, IP67. QD models rated IP69K per DIN 40050-9.
Operating Conditions	<b>Temperature:</b> -40° to +70° C <b>Relative humidity:</b> 90% at 50° C (non-condensing)
Vibration and Mechanical Shock	All models meet Mil. Std. 202F requirements. Method 201A (Vibration; frequency 10 to 60 Hz, max., double amplitude 0.06-inch acceleration 10G). Method 213B conditions H&I (Shock: 75G with unit operating; 100G for non-operation)
Certifications	

# Q40 Series

## Long-Range Sensors



- Reliable sensing without adjustments
- Completely epoxy-encapsulated for superior durability
- Long-range sensing in harsh environments
- Available in 10-30 V dc or 20-250 V ac
- Available in opposed, retroreflective and fixed-field modes
- Cordsets and brackets see page 82

### Opposed Q40, 10-30 V DC

Infrared LED

Sensing Mode	Range	Connection	Models NPN	Models PNP
 OPPOSED	60 m	2 m 4-Pin Euro QD	Q406E Emitter Q406EQ Emitter	
	60 m	2 m 4-Pin Euro QD	Q40SN6R Q40SN6RQ	Q40SP6R Q40SP6RQ

### Polar Retro Q40, 10-30 V DC

Visible Red LED

Sensing Mode	Range	Connection	Models NPN	Models PNP
 POLAR RETRO	6 m†	2 m	Q40SN6LP	Q40SP6LP
	6 m	4-Pin Euro QD	Q40SN6LPQ	Q40SP6LPQ

### Fixed-Field Q40, 10-30 V DC

Infrared LED

Sensing Mode	Range	Connection	Models NPN	Models PNP
 FIXED-FIELD	0 - 200 mm Cutoff	2 m 4-Pin Euro QD	Q40SN6FF200 Q40SN6FF200Q	Q40SP6FF200 Q40SP6FF200Q
	0 - 400 mm Cutoff	2 m 4-Pin Euro QD	Q40SN6FF400 Q40SN6FF400Q	Q40SP6FF400 Q40SP6FF400Q
	0 - 600 mm Cutoff	2 m 4-Pin Euro QD	Q40SN6FF600 Q40SN6FF600Q	Q40SP6FF600 Q40SP6FF600Q
	0 - 200 mm Cutoff	2 m 4-Pin Euro QD	Q40SN6FF200 Q40SN6FF200Q	Q40SP6FF200 Q40SP6FF200Q
	0 - 400 mm Cutoff	2 m 4-Pin Euro QD	Q40SN6FF400 Q40SN6FF400Q	Q40SP6FF400 Q40SP6FF400Q
	0 - 600 mm Cutoff	2 m 4-Pin Euro QD	Q40SN6FF600 Q40SN6FF600Q	Q40SP6FF600 Q40SP6FF600Q

For more specifications see page 82.

Connection options: A model with a QD requires a mating cordset (see page 82).

For 9 m cable, add suffix W/30 to the 2 m model number (example, Q40SN6R W/30).

† Retroreflective range is specified using a BRT-3 retroreflector.

Actual sensing range may differ, depending on the efficiency and reflective area of the retroreflector used. See Accessories for more information.

Opposed Q40, 20-250 V AC

 Infrared LED

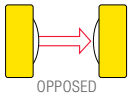
Sensing Mode	Range	Connection	Models LO	Models DO
	60 m	2 m	Q403E Emitter	
		4-Pin Micro QD	Q403EQ1 Emitter	
	60 m	2 m	Q40AW3R	Q40RW3R
		4-Pin Micro QD	Q40AW3RQ1	Q40RW3RQ1

Polar Retro Q40, 20-250 V AC

 Visible Red LED

Sensing Mode	Range	Connection	Models LO	Models DO
	6 m <sup>†</sup>	2 m	Q40AW3LP	Q40RW3LP
		4-Pin Micro QD	Q40AW3LPQ1	Q40RW3LPQ1

Fixed-Field Q40, 20-250 V AC

 Infrared LED

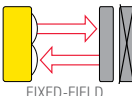
Sensing Mode	Range	Connection	Models LO	Models DO
	0 - 200 mm Cutoff	2 m	Q40AW3FF200	Q40RW3FF200
		4-Pin Micro QD	Q40AW3FF200Q1	Q40RW3FF200Q1
	0 - 400 mm Cutoff	2 m	Q40AW3FF400	Q40RW3FF400
		4-Pin Micro QD	Q40AW3FF400Q1	Q40RW3FF400Q1
	0 - 600 mm Cutoff	2 m	Q40AW3FF600	Q40RW3FF600
		4-Pin Micro QD	Q40AW3FF600Q1	Q40RW3FF600Q1

For more specifications see page 82.

 Connection options: A model with a QD requires a mating cordset (see page 82).

For 9 m cable, add suffix W/30 to the 2 m model number (example, Q40SN6R W/30).

<sup>†</sup> Retroreflective range is specified using a BRT-3 retroreflector.  
Actual sensing range may differ, depending on the efficiency and reflective area of the retroreflector used. See Accessories for more information.



4-Pin

**Euro-Style**  
Straight connector models listed; for right-angle, add **RA** to the end of the model number (example, **MQDC-406RA**)

**MQDC-406**  
2 m (6.5')  
**MQDC-415**  
5 m (15')  
**MQDC-430**  
9 m (30')



4-Pin

**Micro-Style**  
Straight connector models listed; for right-angle, add **RA** to the end of the model number (example, **MQDC-306RA**)

**MQAC-406**  
2 m (6.5')  
**MQAC-415**  
5 m (15')  
**MQAC-430**  
9 m (30')

Additional cordset information is available  
See page 758



SMB30A



SMB30FA..

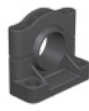

SMB30SC



SMBAMS30P

Additional bracket information is available  
See page 722

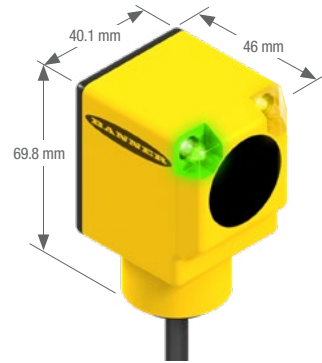

Opposed,  
Polarized Retroreflective  
and Fixed-Field Models  
Suffix E, R, LP and FF

Reflectors



Apertures



Additional information is available  
See page 790

Additional information is available  
See page 816

Q40 DC Specifications

Supply Voltage and Current	10 to 30 V dc (10% max. ripple); Supply current (exclusive of load current): <b>Opposed Emitters:</b> 25 mA <b>Opposed Receivers:</b> 20 mA <b>Polarized Retroreflective:</b> 30 mA <b>Fixed-Field:</b> 35 mA
Supply Protection Circuitry	Protected against reverse polarity and transient voltages
Output Configuration	Solid-state complementary; choose NPN (current sinking) or PNP (current sourcing) models The Dark Operate (DO) output may be wired as a normally open marginal signal alarm output, depending upon hookup to the power supply
Output Rating	150 mA max. (each) in standard hookup; When wired for alarm output, the total load may not exceed 150 mA <b>OFF-state leakage current:</b> less than 1 µA at 30 V dc <b>ON-state saturation voltage:</b> less than 1 V at 10 mA dc; less than 1.5 V at 150 mA dc
Output Protection Circuitry	Protected against false pulse on power-up and continuous overload or short circuit of outputs
Output Response Time	<b>Opposed:</b> 3 milliseconds ON; 1.5 milliseconds OFF <b>Polarized Retroreflective and Fixed-Field:</b> 3 milliseconds ON/OFF
Delay at Power-up	100 milliseconds; outputs are non-conducting during this time
Repeatability	<b>Opposed:</b> 375 microseconds <b>Polarized Retroreflective and Fixed-Field:</b> 750 microseconds Repeatability and response are independent of signal strength
Indicators	<b>Two LEDs:</b> Green and Yellow <b>Solid Green:</b> Power ON <b>Solid Yellow:</b> Light Operate (LO) output energized See datasheet for detailed information <b>Flashing Green:</b> Output over loaded <b>Flashing Yellow:</b> Marginal excess gain
Construction	Housings are thermoplastic polyester. Lenses are polycarbonate or acrylic; one jam nut included.
Environmental Rating	Leakproof design rated NEMA 6P, IP67. QD models rated IP69K per DIN 40050-9.
Connections	2 m or 9 m attached cable, or 4-pin Euro-style quick-disconnect fitting. QD cordsets are ordered separately. See page 82.
Operating Conditions	<b>Temperature:</b> -40° to +70° C <b>Relative humidity:</b> 90% at 50° C (non-condensing)
Vibration and Mechanical Shock	All models meet Mil. Std. 202F requirements. Method 201A (Vibration; frequency 10 to 60 Hz, max., double amplitude 0.06-inch acceleration 10G). Method 213B conditions H&I (Shock: 75G with unit operating; 100G for non-operation)



Certifications



ECOLAB® chemical compatibility pending on some models; contact Banner Engineering for details



## Q40 AC Specifications

Supply Voltage and Current	20 to 250 V ac (50/60 Hz) <b>Average current:</b> 20 mA <b>Peak current:</b> 200 mA at 20 V ac, 500 mA at 120 V ac, 750 mA at 250 V ac
Supply Protection Circuitry	Protected against transient voltages
Output Configuration	Solid-state ac switch; three-wire hookup; choose Light Operate (LO) or Dark Operate (DO) models <b>Light Operate:</b> Output conducts when the sensor sees its own (or the emitter's) modulated light <b>Dark Operate:</b> Output conducts when sensor sees dark
Output Rating	300 mA max. (continuous) <b>Fixed-Field:</b> derate 5 mA/° C above +50° C <b>Inrush capability:</b> 1 amp for 20 milliseconds, non-repetitive <b>OFF-state leakage current:</b> less than 100 µA <b>ON-state voltage drop:</b> 3 V at 300 mA ac; 2 V at 15 mA ac
Output Protection Circuitry	Protected against false pulse on power-up
Output Response Time	<b>Opposed:</b> 16 milliseconds ON; 8 milliseconds OFF <b>Polarized Retroreflective and Fixed-Field:</b> 16 milliseconds ON/OFF
Delay at Power-up	100 milliseconds
Repeatability	<b>Opposed:</b> 2 milliseconds <b>Polarized Retroreflective and Fixed-Field:</b> 4 milliseconds Repeatability and response are independent of signal strength
Indicators	<b>Two LEDs:</b> Green and Yellow <b>Solid Green:</b> Power ON <b>Solid Yellow:</b> Light sensed <b>Flashing Yellow:</b> marginal excess gain See datasheet for detailed information
Construction	Housings are thermoplastic polyester. Lenses are polycarbonate or acrylic; one jam nut included.
Environmental Rating	Leakproof design rated NEMA 6P, IP67. QD models rated IP69K per DIN 40050-9.
Connections	2 m or 9 m attached cable, or 4-pin Micro-style quick-disconnect fitting. QD cordsets are ordered separately. See page 82.
Operating Conditions	<b>Temperature:</b> -40° to +70° C <b>Relative humidity:</b> 90% at 50° C (non-condensing)
Vibration and Mechanical Shock	All models meet Mil. Std. 202F requirements. Method 201A (Vibration; frequency 10 to 60 Hz, max, double amplitude 0.06-inch acceleration 10G). Method 213B conditions H&I (Shock: 75G with unit operating; 100G for non-operation)
Certifications	   ECOLAB® chemical compatibility pending on some models; contact Banner Engineering for details

# Q45 Series

## Adjustable Output Timing Logic



- The Q45 Standard sensor is available in multiple sensing modes to suit many application needs.
- Opposed, retroreflective, diffuse, convergent, laser and glass and plastic fiber optic modes
- Electromechanical or solid-state options
- Rugged design rated to IP67 to withstand 1200 psi washdown

**Euro-Style**  
Straight connector models listed;  
for right-angle, add **RA** to the end  
of the model number  
(example, **MQDC-406RA**)



4-Pin	5-Pin
<b>MQDC-406</b> 2 m (6.5')	<b>MQDC1-506</b> 2 m (6.5')
<b>MQDC-415</b> 5 m (15')	<b>MQDC1-515</b> 5 m (15')
<b>MQDC-430</b> 9 m (30')	<b>MQDC1-530</b> 9 m (30')

**Micro-Style**  
Straight connector models listed;  
for right-angle, add **RA** to the end  
of the model number  
(example, **MQAC-406RA**)



4-Pin
<b>MQAC-406</b> 2 m (6.5')
<b>MQAC-415</b> 5 m (15')
<b>MQAC-430</b> 9 m (30')

**Mini-Style**  
Straight connector models only



3-Pin	4-Pin	5-Pin
<b>MBCC-306</b> 2 m (6.5')	<b>MBCC-406</b> 2 m (6.5')	<b>MBCC-506</b> 2 m (6.5')
<b>MBCC-315</b> 5 m (15')	<b>MBCC-415</b> 5 m (15')	<b>MBCC-515</b> 5 m (15')
<b>MBCC-330</b> 9 m (30')	<b>MBCC-430</b> 9 m (30')	<b>MBCC-530</b> 9 m (30')

**NAMUR Euro-Style**  
Straight connector models listed;  
for right-angle, add **RA** to the end  
of the model number  
(example, **MQD9-406RA**)



4-Pin
<b>MQD9-406</b> 2 m (6.5')
<b>MQD9-415</b> 5 m (15')

*Additional cordset information is available  
See page 758*



SMB30A



SMB30FA..

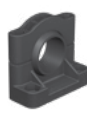

SMB30SC

*Additional bracket information is available  
See page 722*

### Reflectors

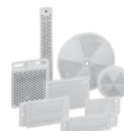

*Additional information is available  
See page 790*

### Apertures



*Additional information is available  
See page 816*

### Q45 Specifications

Visit [Bannerengineering.com](http://Bannerengineering.com) for more information on this and other products



Opposed, Retroreflective and Diffuse Models  
Suffix E, R, D, DL, DX, LV and LP



Convergent Models  
Suffix CV and CV4



Retroreflective Laser Models  
Suffix LL and LLP

### OTHER AVAILABLE MODELS



Wireless Q45 page 512



Plastic Fiber Q45 see website



Glass Fiber Q45 see website

# Q45 Wireless

## Self-Contained Wireless Solution



- Improve efficiency by monitoring and coordinating multiple machines and processes without pulling cables
- 1 km line-of-sight
- Built-in antenna
- 2.4 GHz unlicensed frequency
- Used exclusively with Banner's DX80 Gateway (see page 512)

### Retroflective Q45 Wireless

➔ Visible Red LED

Sensing Mode	Sensing Range	Wireless Communication Range	Output	Models
 POLAR RETRO	6 m	1,000 m (with line of sight)	Discrete output via Gateway	DX80N2Q45LP

### Diffuse Q45 Wireless

➔ Visible Red LED

Sensing Mode	Sensing Range	Wireless Communication Range	Output	Models
 DIFFUSE	300 mm	1,000 m (with line of sight)	Discrete output via Gateway	DX80N2Q45D

### Convergent Q45 Wireless

➔ Visible Red LED

Sensing Mode	Sensing Range	Wireless Communication Range	Output	Models
 CONVERGENT	38 mm	1,000 m (with line of sight)	Discrete output via Gateway	DX80N2Q45CV

Fiber Optic Q45 Wireless

➔ Visible Red LED

Sensing Mode	Sensing Range	Wireless Communication Range	Output	Models
	varies by selected fiber	1,000 m (with line of sight)	Discrete output via gateway	DX80N2Q45F

Q45 Wireless Specifications

Visit [Bannerengineering.com](http://Bannerengineering.com) for more information on this and other products



Opposed, Retroreflective and Diffuse Models  
Suffix E, R, D, DL, DX, LV and LP

OTHER AVAILABLE MODELS



Q45 page 84



Plastic Fiber Q45 see website



Glass Fiber Q45 see website



# Q60 Series

## Long-Range, Adjustable-Field Sensors



- Detects objects with a defined sensing field, ignoring objects located beyond the sensing point
- Output timing ON/OFF
- Available in 10-30 V dc, 12-250 V dc or 24-250 V ac
- Features two-turn, logarithmic adjustment of sensing field cutoff point from 0.2 to 2 m
- Easy push-button or remote programming of output timing
- Cordsets and brackets see page 90

### Adjustable-Field Q60, 10-30 V DC

Infrared LED

Visible Red LED

Sensing Mode	Range	Connection	Output Type	Models
 ADJUSTABLE-FIELD	<b>Min.:</b> 65 - 130 mm <sup>†</sup> <b>Cutoff:</b> 200 - 1000 mm	2 m	Bipolar NPN/PNP	Q60BB6AFV1000
		5-Pin Euro QD		Q60BB6AFV1000Q
 ADJUSTABLE-FIELD	<b>Min.:</b> 50 - 125 mm <sup>†</sup> <b>Cutoff:</b> 200 - 2000 mm	2 m	Bipolar NPN/PNP	Q60BB6AF2000
		5-Pin Euro QD		Q60BB6AF2000Q

### Laser Adjustable-Field Q60, 10-30 V DC

Visible Red Laser

Sensing Mode	Range	Connection	Output Type	Models
 CLASS 1 LASER LASER ADJUSTABLE-FIELD	<b>Min.:</b> 100 - 260 mm <sup>†</sup> <b>Cutoff:</b> 200 - 1400 mm	2 m	Bipolar NPN/PNP	Q60BB6LAF1400
		5-Pin Euro QD		Q60BB6LAF1400Q
 CLASS 2 LASER LASER ADJUSTABLE-FIELD	<b>Min.:</b> 75 - 240 mm <sup>†</sup> <b>Cutoff:</b> 200 - 2000 mm	2 m	Bipolar NPN/PNP	Q60BB6LAF2000
		5-Pin Euro QD		Q60BB6LAF2000Q

For more specifications see page 91.

Connection options: A model with a QD requires a mating cordset (see page 90).

For 9 m cable, add suffix W/30 to the 2 m model number (example, Q60BB6AF2000 W/30).

<sup>†</sup> Minimum range varies by established cutoff point (see excess gain curves, page 142 and cutoff point deviation curves, page 143).

Adjustable-Field Q60, 12-250 V DC or 24-250 V AC



Sensing Mode	Range	Connection	Output Type	Models
 ADJUSTABLE-FIELD	<b>Min.:</b> 65 - 130 mm <sup>†</sup> <b>Cutoff:</b> 200 - 1000 mm	2 m	SPDT e/m Relay	Q60VR3AFV1000
		4-Pin Micro QD	SPDT e/m Relay	Q60VR3AFV1000Q1
 ADJUSTABLE-FIELD	<b>Min.:</b> 50 - 125 mm <sup>†</sup> <b>Cutoff:</b> 200 - 2000 mm	2 m	SPDT e/m Relay	Q60VR3AF2000
		4-Pin Micro QD	SPDT e/m Relay	Q60VR3AF2000Q1

Laser Adjustable-Field Q60, 12-250 V DC or 24-250 V AC



Sensing Mode	Range	Connection	Output Type	Models
 ADJUSTABLE-FIELD	<b>Min.:</b> 100 - 260 mm <sup>†</sup> <b>Cutoff:</b> 200 - 1400 mm	2 m	SPDT e/m Relay	Q60VR3LAF1400
		4-Pin Micro QD	SPDT e/m Relay	Q60VR3LAF1400Q1
 ADJUSTABLE-FIELD	<b>Min.:</b> 75 - 240 mm <sup>†</sup> <b>Cutoff:</b> 200 - 2000 mm	2 m	SPDT e/m Relay	Q60VR3LAF2000
		4-Pin Micro QD	SPDT e/m Relay	Q60VR3LAF2000Q1

For more specifications see page 91.

Connection options: A model with a QD requires a mating cordset (see page 90).  
 For 9 m cable, add suffix W/30 to the 2 m model number (example, Q60VR3AFV1000 W/30).  
<sup>†</sup> Minimum range varies by established cutoff point (see excess gain curves, page 142 and cutoff point deviation curves, page 143).



**5-Pin**  
**MQDC1-506**  
 2 m (6.5')  
**MQDC1-515**  
 5 m (15')  
**MQDC1-530**  
 9 m (30')

**Euro-Style**  
 Straight connector models listed;  
 for right-angle, add **RA** to the end  
 of the model number (example,  
**MQDC1-506RA**)



**4-Pin**  
**MQAC-406**  
 2 m (6.5')  
**MQAC-415**  
 5 m (15')  
**MQAC-430**  
 9 m (30')

**Micro-Style**  
 Straight connector models listed;  
 for right-angle, add **RA** to the end  
 of the model number (example,  
**MQAC-406RA**)

Additional cordset information is available  
 See page page 758



Adjustable-Field Models  
 Suffix AF, AFV and LAF



SMBAMSQ60IP



SMBAMSQ60P

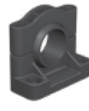

SMBQ60

Additional bracket information is available  
 See page page 722



**Class 1 Lasers**

Lasers that are safe under reasonably foreseeable conditions of operation, including the use of optical instruments for intrabeam viewing. Reference 60825-1 Amend. 2 © IEC:2001(E), section 8.2.

**For safe laser use:**

- Do not permit a person to stare at the laser from within the beam
- Do not point the laser at a person's eye at close range
- Locate open laser beam paths either above or below eye level, where practical

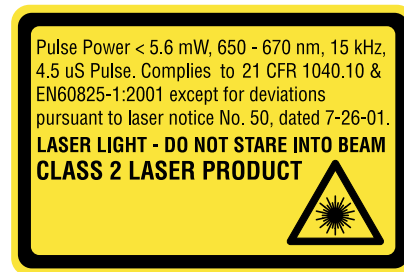



**Class 2 Lasers**

Lasers that emit visible radiation in the wavelength range from 400 nm to 700 nm where eye protection is normally afforded by aversion responses, including the blink reflex. This reaction may be expected to provide adequate protection under reasonably foreseeable conditions of operation, including the use of optical instruments for intrabeam viewing. Reference 60825-1 Amend. 2 © IEC:2001(E), section 8.2.

**For safe laser use:**

- Do not permit a person to stare at the laser from within the beam
- Do not point the laser at a person's eye at close range
- Locate open laser beam paths either above or below eye level, where practical

## Q60 Specifications

Supply Voltage and Current	<b>Q60BB6AF and Q60BB6AFV models:</b> 10 to 30 V dc (10% max. ripple) at less than 50 mA exclusive of load <b>Q60BB6LAF models:</b> 10 to 30 V dc (10% max. ripple) at less than 35 mA exclusive of load <b>Q60VR3LAF and Q60VR3AFV Universal models:</b> 12 to 250 V dc or 24 to 250 V ac, 50/60 Hz Input power 1.5 W max.	
Supply Protection Circuitry	Protected against reverse polarity and transient voltages (Q60VR3 model's dc hookup is without regard to polarity)	
Output Configuration	<b>Q60BB6AF, Q60BB6AFV and Q60BB6LAF models:</b> Bipolar: one NPN (current sinking) and one PNP (current sourcing) open-collector transistor <b>Q60VR3AF, Q60VR3LAF and Q60VR3AFV cabled models:</b> E/M Relay (SPDT), normally closed and normally open contacts <b>Q60VR3AFQ1, Q60VR3AFVQ1 and Q60VR3LAFQ1 (QD) models:</b> E/M Relay (SPST), normally open contact	
Output Rating	<b>DC models:</b> 150 mA max. each output @ 25 °C <b>OFF-state leakage current:</b> less than 5 µA @ 30 V dc <b>Output saturation NPN:</b> less than 200 mV @ 10 mA; less than 1 V @ 150 mA <b>Output saturation PNP:</b> less than 1 V at 10 mA; less than 1.5 V at 150 mA  <b>Universal Voltage models:</b> <b>Min. voltage and current:</b> 5 V dc, 10 mA <b>Mechanical life of relay:</b> 50,000,000 operations <b>Electrical life of relay at full resistive load:</b> 100,000 operations <b>Max. switching power (resistive load): Cabled models:</b> 1250 VA, 150 W <b>QD models:</b> 750 VA, 90 W <b>Max. switching voltage (resistive load): Cabled models:</b> 250 V ac, 125 V dc <b>QD models:</b> 250 V ac, 125 V dc <b>Max. switching current (resistive load):</b> <b>Cabled models:</b> 5 A @ 250 V ac, 5 A @ 30 V dc derated to 200 mA @ 125 V dc <b>QD models:</b> 3 A @ 250 V ac, 3 A @ 30 V dc derated to 200 mA @ 125 V dc	
Output Protection Circuitry	<b>Q60BB6AF, Q60BB6LAF and Q60BB6AFV models:</b> Protected against continuous overload or short circuit of outputs <b>All models:</b> Protected against false pulse on power-up	
Output Response Time	<b>Q60BB6AF, Q60BB6LAF and Q60BB6AFV models:</b> 2 milliseconds ON/OFF <b>Q60VR3AF, Q60VR3LAF and Q60VR3AFV Universal models:</b> 15 milliseconds ON/OFF	
Delay at Power-up	150 milliseconds (Q60BB6LAF has 1 second max.); outputs do not conduct during this time	
Repeatability	500 microseconds	
Sensing Hysteresis	<b>2000 mm cutoff</b> - less than 3% of set cutoff distance <b>1600 mm cutoff</b> - less than 2.25% of set cutoff distance <b>1200 mm cutoff</b> - less than 1.30% of set cutoff distance	<b>800 mm cutoff</b> - less than 0.5% of set cutoff distance <b>400 mm cutoff</b> - less than 0.25% of set cutoff distance
Adjustments	<b>2 momentary push buttons:</b> ON-delay and OFF-delay <b>ON Delay select:</b> 8 milliseconds to 16 seconds <b>LO/DO select</b> <b>OFF Delay select:</b> 8 milliseconds to 16 seconds <b>Push-button lockout:</b> for security Slotted, geared, 2-turn, cutoff range adjustment screw (mechanical stops on both ends of travel)	
Indicators	<b>Q60AF, Q60AFV and Q60LAF models:</b> <b>ON-Delay</b> <b>Green ON Steady:</b> Run mode, ON-delay is active <b>Green Flashing:</b> ON-delay Selection mode is active <b>OFF-Delay</b> <b>Green ON Steady:</b> Run mode, OFF-delay is active <b>Green Flashing:</b> OFF-delay Selection mode is active  <b>5-Segment Light Bar*:</b> Indicates relative delay time during ON/OFF-delay Selection modes <b>Output</b> <b>Amber ON Steady:</b> Outputs are conducting <b>Green ON Steady:</b> During ON/OFF-delay Selection modes <b>Dark Operate</b> <b>Green ON Steady:</b> Dark Operate is selected <b>Lockout</b> <b>Green ON Steady:</b> Buttons are locked out <b>Light Operate</b> <b>Green ON Steady:</b> Light Operate is selected <b>Signal</b> <b>Green ON Steady:</b> Sensor is receiving signal <b>Green Flashing:</b> Marginal signal (1.0 to 2.25 excess gain)	
NOTE: Outputs are active during on/off timing selection mode.	*Output, Dark Operate, Lockout, Light Operate and Signal indicators function as 5-Segment Light Bar during ON/OFF-delay Selection modes	
Laser Characteristics	<b>Spot Size:</b> approximately 4 x 2 mm throughout range (collimated beam) <b>Angle of Divergence:</b> 5 milliradians NOTE: Contact factory for custom laser spot size.	
Construction	<b>Housing:</b> ABS polycarbonate blend <b>Lens:</b> acrylic <b>Cover:</b> Clear ABS	
Environmental Rating	IEC IP67; NEMA 6	
Connections	2 m or 9 m integral cable. DC models offer a 5-pin Euro-style QD fitting. AC models offer 4-pin Micro-style QD fitting. QD cordsets are ordered separately. See page 90.	
Operating Conditions	<b>Temperature: Q60BB6LAF (DC) models:</b> -10° to +50° C <b>Q60VR3LAF Universal models:</b> -10° to +45° C <b>All others:</b> -20° to +55° C <b>Relative humidity:</b> 90% at 50° C (non-condensing)	
Certifications	 	

# PicoDot®

## Laser Precision Sensors



- Convergent-mode laser sensor delivers precise position detection, inspection and counting
- Powerful retroreflective models offer long-range retroreflective sensing and have a precise, narrow beam to sense small objects at close range or larger objects at 10.6 m
- Convergent models have precise 0.25 mm beam width and ignore objects beyond the maximum sensing distance
- All models have a gain sensitivity potentiometer for fine tuning sensor performance
- Models available with environmentally sealed housing

### Laser Polar Retro PicoDot®, 10-30 V DC

➔ Visible Red LED

Sensing Mode	Range/Focus	Connection	Housing Rating	Models NPN	Models PNP
<p>CLASS 2 LASER POLAR RETRO</p>	0.2 m - 10.6 m†	2 m	IP54, NEMA 3	PD45VN6LLP	PD45VP6LLP
		5-pin Euro Pigtail QD		PD45VN6LLPQ	PD45VP6LLPQ
	0.2 m - 10.6 m†	2 m	IP67, NEMA 6	PD49VN6LLP	PD49VP6LLP
		5-pin Euro Pigtail QD		PD49VN6LLPQ	PD49VP6LLPQ

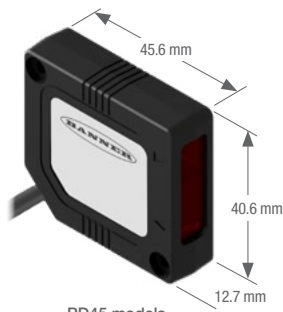

PD45 models  
Laser Polarized Retroreflective  
and Laser Convergent Models  
Suffix LLP and C..

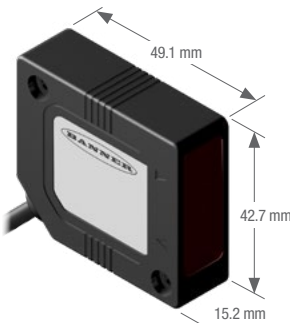

PD49 models  
Laser Polarized Retroreflective  
and Laser Convergent Models  
Suffix LLP and C..

### Laser Convergent PicoDot®, 10-30 V DC

➔ Visible Red LED

Sensing Mode	Range/Focus	Connection	Housing Rating	Models NPN	Models PNP
<p>CLASS 2 LASER CONVERGENT</p>	50 mm	2 m	IP54, NEMA 3	PD45VN6C50	PD45VP6C50
		5-pin Euro Pigtail QD		PD45VN6C50Q	PD45VP6C50Q
		2 m	IP67, NEMA 6	PD49VN6C50	PD49VP6C50
		5-pin Euro Pigtail QD		PD49VN6C50Q	PD49VP6C50Q
	102 mm	2 m	IP54, NEMA 3	PD45VN6C100	PD45VP6C100
		5-pin Euro Pigtail QD		PD45VN6C100Q	PD45VP6C100Q
		2 m	IP67, NEMA 6	PD49VN6C100	PD49VP6C100
		5-pin Euro Pigtail QD		PD49VN6C100Q	PD49VP6C100Q
	203 mm	2 m	IP54, NEMA 3	PD45VN6C200	PD45VP6C200
		5-pin Euro Pigtail QD		PD45VN6C200Q	PD45VP6C200Q
		2 m	IP67, NEMA 6	PD49VN6C200	PD49VP6C200
		5-pin Euro Pigtail QD		PD49VN6C200Q	PD49VP6C200Q
	305 mm	2 m	IP54, NEMA 3	PD45VN6C300	PD45VP6C300
		5-pin Euro Pigtail QD		PD45VN6C300Q	PD45VP6C300Q
	305 mm	2 m	IP67, NEMA 6	PD49VN6C300	PD49VP6C300
				5-pin Euro Pigtail QD	PD49VN6C300Q

➔ Connection options: A model with a QD requires a mating cordset.

For 9 m cable, add suffix W/30 to the 2 m model number (example, PD45VN6LLP W/30).

† Tested using a BRT-51X51BM retro target (included with each sensor). Actual range depends on the efficiency and size of the retroreflective target. Some targets have produced ranges up to 40 m.





**Euro-Style**  
Straight connector models listed; for right-angle, add **RA** to the end of the model number (example, **MQDC1-506RA**)

**5-Pin**  
**MDDC-501.5**  
.5 m (1.6')  
**MQDC1-506**  
2 m (6.5')  
**MQDC1-515**  
5 m (15')  
**MQDC1-530**  
9 m (30')



SMB46A



SMB46S



SMB46L



SMB46U

Additional cordset information is available  
See page page 758

Additional bracket information is available  
See page page 723

### Class 2 Laser Safety Notes

Low-power lasers are by definition incapable of causing eye injury within the duration of the blink (aversion response) of 0.25 seconds. They also must emit only visible wavelengths (400 - 700 nm). Therefore, an ocular hazard can exist only if an individual overcomes their natural aversion to bright light and stares directly into the laser beam.

### For safe laser use:

- Do not permit a person to stare at the laser from within the beam
- Do not point the laser at a person's eye at close range
- The beam emitted by a Class 2 laser product should be terminated at the end of its useful path. Open laser beam paths should be located above or below eye level where practical.

**LASER LIGHT**  
DO NOT STARE INTO BEAM  
CLASS 2 LASER PRODUCT

Avoid exposure - laser light emitted from this aperture

PEAK POWER 2 mW  
20KHz 10% DUTY CYCLE  
660 - 680 nm  
COMPLIES TO 21 CFR PART  
1040.10 AND EN60825-1:1994

### PicoDot® Specifications

Supply Voltage and Current	10 to 30 V dc (10% max ripple) at less than 20 mA, exclusive of load
Beam Size at Aperture	3.75 x 1.85 mm (Retroreflective Models)
Beam Divergence	Approx. 1 milliradian (Retroreflective Models)
Laser Classification	Class 2 safety (CDRH (FDA) 1040.10 and IEC 60875-1)
Supply Protection Circuitry	Protected against reverse polarity, over voltage, and transient voltages
Delay at Power-up	< 1 second
Output Configuration	Solid-state complementary; choose NPN (current sinking) or PNP (current sourcing) models
Output Rating	150 mA max. (each output) <b>OFF-state leakage current:</b> less than 1 µA at 30 V dc <b>ON-state saturation voltage:</b> less than 0.3 V at 10 mA dc; less than 0.8 V at 150 mA dc
Output Protection	Protected against continuous overload or short-circuit of outputs; Overload trip point ≥ 220 milliamps
Output Response Time	0.2 milliseconds (200 microseconds) ON/OFF
Repeatability	50 microseconds; Rep Rate 20 KHz
Spot Size at Focus	0.25 mm
Range	<b>C50 models:</b> 25 to 58 mm; focus at 50 mm ± 5 mm <b>C100 models:</b> 25 to 115 mm; focus at 102 mm ± 5 mm <b>C200 models:</b> 25 to 216 mm; focus at 203 mm ± 5 mm <b>C300 models:</b> 25 to 317 mm; focus at 305 mm ± 5 mm <b>LLP models:</b> 0.2 to 10.6 m, using supplied retroreflective target
Adjustments	12-turn slotted brass Gain (sensitivity) adjustment potentiometer
Extinguishing Wire	Gray wire held "low" for laser operation; "high" to turn laser OFF; Low ≤ 1.0 V dc; High ≥ Vsupply -4.0 V dc (< 30 V dc) or disconnect wire; 100 milliseconds delay upon enable
Indicators	<b>Two LEDs:</b> <b>Solid Green:</b> Power ON <b>Flashing Green:</b> output overloaded <b>Solid Yellow:</b> Light sensed; Light Operate (LO) output conducting <b>Flashing Yellow:</b> marginal excess gain See datasheet for detailed information
Construction	<b>PD45:</b> Housings are heat-resistant ABS, UL94-VO rated; acrylic lens cover <b>PD49:</b> Housings are sealed, heat resistant ABS/polycarbonate alloy, UL94-VO rated, acrylic lens cover
Environmental Rating	<b>PD45:</b> IP54; NEMA 3 <b>PD49:</b> IP67; NEMA 6
Connections	2 m or 9 m attached cable, or 5-pin Euro-style 150 mm pigtail quick-disconnect fitting; mating cordsets for QD models are ordered separately.
Operating Conditions	<b>Temperature:</b> -10° to +45° C <b>Relative humidity:</b> 90% at 50° C (non-condensing)
Weight	<b>PD45: Sensor only:</b> 22 g <b>PD49: Sensor only:</b> 28 g <b>Sensor plus 2 m cable:</b> 62 g <b>Sensor plus 2 m cable:</b> 68 g
Application Notes	False pulse may occur less than 1 second after power-up



# QM42 Series

## Rectangle Sensor with Mounting Versatility



- Versatile sensor with several mounting options
- Meets IP67 and NEMA 6 standards for harsh environment
- Universal housing design
- Cordsets and brackets see page 96

### Opposed QM42, 10-30 V DC

⇒ Infrared LED

Sensing Mode	Range	Connection	Models NPN	Models PNP
<p>OPPOSED</p>	10 m	2 m	QM426E Emitter	
		4-Pin Euro QD	QM426EQ Emitter	
		2 m	QM42VN6R	QM42VP6R
		4-Pin Euro QD	QM42VN6RQ	QM42VP6RQ

### Polar Retro QM42, 10-30 V DC

⇒ Visible Red LED

Sensing Mode	Range	Connection	Models NPN	Models PNP
<p>POLAR RETRO</p>	3 m†	2 m	QM42VN6LP	QM42VP6LP
		4-Pin Euro QD	QM42VN6LPQ	QM42VP6LPQ

### Diffuse QM42, 10-30 V DC

⇒ Infrared LED

Sensing Mode	Range	Connection	Models NPN	Models PNP
<p>DIFFUSE</p>	400 mm	2 m	QM42VN6D	QM42VP6D
		4-Pin Euro QD	QM42VN6DQ	QM42VP6DQ

### Adjustable-Field QM42, 10-30 V DC

⇒ Visible Red LED

Sensing Mode	Range	Connection	Models NPN	Models PNP
<p>SHORT RANGE ADJUSTABLE-FIELD</p>	5 mm to Cutoff point (adjustable from 50 to 150 mm)	2 m	QM42VN6AFV150	QM42VP6AFV150
		4-Pin Euro QD	QM42VN6AFV150Q	QM42VP6AFV150Q



QM42 Opposed, Retroreflective, Short-range Diffuse, and Short-range Adjustable-Field Model Suffix E, R, LP, D, AFV150 and FP

For more specifications see page 97.

Connection options: A model with a QD requires a mating cordset (see page 96).

For 9 m cable, add suffix W/30 to the 2 m model number (example, QM42VN6 LP W/30).

† Tested using a BRT-3 retroreflector. Actual range depends on the efficiency and reflective area of the retroreflector in use. See Accessories for more information.

# QMT42 Series

## Rectangle Sensor with Mounting Versatility



- Versatile sensor with several mounting options
- Meets IP67 and NEMA 6 standards for harsh environment
- Universal housing design
- All-purpose, go-to sensor for many application needs
- Cordsets and brackets see page 96

### Diffuse QMT42, 10-30 V DC

⇒ Infrared LED

Sensing Mode	Range	Connection	Models NPN	Models PNP
 DIFFUSE	10 mm - 6 m	2 m	QMT42VN6DX	QMT42VP6DX
		4-Pin Euro QD	QMT42VN6DXQ	QMT42VP6DXQ

### Fixed-Field QMT42, 10-30 V DC

⇒ Infrared LED

Sensing Mode	Range	Connection	Models NPN	Models PNP
 FIXED-FIELD	50 - 500 mm Cutoff	2 m	QMT42VN6FF500	QMT42VP6FF500
		4-Pin Euro QD	QMT42VN6FF500Q	QMT42VP6FF500Q
 FIXED-FIELD	50 - 750 mm Cutoff	2 m	QMT42VN6FF750	QMT42VP6FF750
		4-Pin Euro QD	QMT42VN6FF750Q	QMT42VP6FF750Q
 FIXED-FIELD	50 - 1000 mm Cutoff	2 m	QMT42VN6FF1000	QMT42VP6FF1000
		4-Pin Euro QD	QMT42VN6FF1000Q	QMT42VP6FF1000Q
 FIXED-FIELD	50 - 1500 mm Cutoff	2 m	QMT42VN6FF1500	QMT42VP6FF1500
		4-Pin Euro QD	QMT42VN6FF1500Q	QMT42VP6FF1500Q
 FIXED-FIELD	50 - 2000 mm Cutoff	2 m	QMT42VN6FF2000	QMT42VP6FF2000
		4-Pin Euro QD	QMT42VN6FF2000Q	QMT42VP6FF2000Q

### Adjustable-Field QMT42, 10-30 V DC

⇒ Visible Red LED

Sensing Mode	Range	Connection	Models NPN	Models PNP
 LONG RANGE FIXED-FIELD	25 mm to Cutoff point (adjustable from 125 to 400 mm)	2 m	QMT42VN6AFV400	QMT42VP6AFV400
		4-Pin Euro QD	QMT42VN6AFV400Q	QMT42VP6AFV400Q

For more specifications see page 97.

Connection options: A model with a QD requires a mating cordset (see page 96).

For 9 m cable, add suffix W/30 to the 2 m model number (example, QM42VN6LP W/30).



QMT42 Long-range Diffuse, Fixed-Field and Adjustable-Field Model Suffix DX, FF and AFV400



4-Pin  
MQDC-406  
2 m (6.5')  
MQDC-415  
5 m (15')  
MQDC-430  
9 m (30')

**Euro-Style**  
Straight connector models listed;  
for right-angle, add **RA** to the end  
of the model number (example,  
MQDC-406RA)



SMB30SK



SMB46S



SMB46L

Additional cordset information is available  
See page page 758

Additional bracket information is available  
See page page 723

Reflectors



Additional information is available  
See page page 790

Apertures



Additional information is available  
See page page 816

## QM42 and QMT42 Specifications





Sensing Beam	<b>Opposed, Diffuse, Retroreflective, Fixed-Field and Fiber Optic:</b> Infrared, 880 nm; Visible Red, 660 nm <b>Adjustable-Field:</b> Visible Red, 680 nm
Supply Voltage and Current	10 to 30 V dc (10% max. ripple) at less than: <b>Opposed:</b> 30 mA (emitter), 10 mA (receiver) <b>Short-range diffuse and retroreflective:</b> 20 mA <b>Fiber optic:</b> 30 mA <b>Adjustable-Field:</b> 50 mA <b>Fixed -Field and long-range diffuse:</b> 40 mA
Supply Protection Circuitry	Protected against reverse polarity and transient voltages
Output Configuration	Solid-state complementary; choose NPN (current sinking) or PNP (current sourcing) models
Output Rating	100 mA max. (each output) <b>OFF-state leakage current:</b> less than 5 $\mu$ A at 30 V dc <b>ON-state saturation voltage:</b> less than 1 V at 10 mA dc; less than 1.5 V at 100 mA dc
Output Protection Circuitry	Protected against false pulse on power-up and continuous overload or short circuit of outputs Overload trip point $\geq$ 150 mA, typical at 20° C
Output Response Time	<b>Opposed:</b> 1 millisecond ON; 0.5 millisecond OFF <b>Diffuse, Retroreflective, Adjustable-Field and Fixed-Field:</b> 1 millisecond ON/OFF <b>Plastic Fiber Optic:</b> 0.25 millisecond ON/OFF
Delay at Power-up	100 milliseconds; outputs are non-conducting during this time
Repeatability	<b>Opposed:</b> 120 microseconds <b>Diffuse, Retroreflective, Adjustable-Field and Fixed-Field:</b> 250 microseconds <b>Fiber Optic:</b> 60 microseconds. Repeatability and response are independent of signal strength
Sensing Hysteresis	<b>Long-range diffuse:</b> less than 20% of set sensing distance <b>Adjustable-Field:</b> less than 7% of set cutoff distance <b>Fixed-Field:</b> 2000 mm models – less than 5% of set cutoff distance 1500 mm models – less than 4% of set cutoff distance 1000 mm models – less than 3% of set cutoff distance 750 mm models – less than 2% of set cutoff distance 500 mm models – less than 1% of set cutoff distance
Cutoff Point Tolerance	<b>Fixed-Field:</b> $\pm$ 10% of nominal cutoff distance
Adjustments	All models (except emitters, Adjustable-Field, Fixed-Field and Long-range Diffuse): 15-turn slotted brass GAIN (sensitivity) adjustment potentiometer <b>150 mm Adjustable-Field:</b> 12-turn slotted brass cutoff distance adjustment potentiometer <b>400 mm Adjustable-Field:</b> 15-turn slotted brass cutoff distance adjustment potentiometer <b>Long-range diffuse:</b> 4-turn slotted GAIN (sensitivity) adjustment potentiometer <b>Fixed-Field:</b> No adjustments See datasheet for detailed information
Indicators	<b>Two LEDs:</b> Green and Yellow <b>Solid Green:</b> Power ON; Opposed emitters: Green power ON <b>Green Flashing:</b> output overloaded <b>Solid Yellow:</b> Light sensed; Light Operate (LO) <b>Yellow Flashing:</b> marginal excess gain See datasheet for detailed information
Construction	Housings are die-cast zinc alloy with black acrylic polyurethane finish; lenses are acrylic
Environmental Rating	IP67; NEMA 6
Connections	2 m or 9 m attached cable, or 4-pin Euro-style quick-disconnect fitting. QD cordsets are ordered separately. See page 96.
Operating Conditions	<b>Temperature:</b> <b>Long-range Diffuse, Adjustable-Field and Fixed-Field:</b> -20° to +55° C <b>All others:</b> -20° to +70° C <b>Relative humidity:</b> 90% at 50° C (non-condensing)
Certifications	



## Right Angle

Right angle sensors offer industry standard 8, 18 and 30 mm barrel mounting options. The right angle housing allows mounting in confined areas, and easy viewing of LED indicators.



Series	Description	Max Sensing Range	Dimensions H x W x D	Protection Rating	Housing Material	Power Supply
	<b>T8</b> Compact sensor provides reliable sensing without adjustments. Page 100	<b>Opposed:</b> 2 m <b>Diffuse:</b> 100 mm	19 x 16.3 x 15.8 mm	IP67; NEMA 6	ABS	10 to 30 V dc
	<b>T18</b> Epoxy-encapsulated right-angle barrel sensors provide reliable sensing without adjustments. Page 102	<b>Opposed:</b> 20 m <b>Retro:</b> 2 m <b>Polarized Retro:</b> 2 m <b>Diffuse:</b> 500 mm <b>Fixed-Field:</b> 100 mm	Varies by model	<b>QD models:</b> IP6K <b>Other models:</b> IP67; NEMA 6	Thermoplastic Polyester	10 to 30 V dc, 20 to 250 V ac
	<b>TM18</b> Robust die-cast metal sensors provide reliable sensing without adjustments in high-pressure washdown environments. Page 106	<b>Opposed:</b> 20 m <b>Polarized Retro:</b> 5.5 m <b>Diffuse:</b> 500 mm <b>Fixed-Field:</b> 100 mm	41 x 30 x 30 mm	<b>QD models:</b> IP6K <b>Other models:</b> IP67; NEMA 6	Zinc die-cast with nickel plating	10 to 30 V dc
	<b>T30</b> Compact sensor provides reliable sensing without adjustments. Page 110	<b>Opposed:</b> 60 m <b>Polarized Retro:</b> 6 m <b>Fixed-Field:</b> 600 mm	51.5 x 40 x 44.8 mm	<b>QD models:</b> IP6K <b>Other models:</b> IP67; NEMA 6	Thermoplastic Polyester	10 to 30 V dc, 20 to 250 V ac

OTHER AVAILABLE MODELS



Q4X page 34



Q3X page 38



QS18 page 40



QS30 page 56

# T8 Series

## Self-Contained, Right-Angle Barrel-Mount



- Powerful optics
- Short-range background suppression
- Highly visible red sensing beam for easy alignment
- Easily replaces range-limited 8 mm inductive proximity sensors

### Opposed T8

Visible Red LED

Sensing Mode	Range	Connection	Output Type	Models NPN	Models PNP
	2 m	2 m	—	T86EV Emitter	
		3-Pin Pico Pigtail QD		T86EVQ Emitter	
		2 m	LO	T8AN6R	T8AP6R
		3-Pin Pico Pigtail QD		T8AN6RQ	T8AP6RQ
2 m	DO	T8RN6R	T8RP6R		
3-Pin Pico Pigtail QD		T8RN6RQ	T8RP6RQ		

### Diffuse T8

Visible Red LED

Sensing Mode	Range	Connection	Output Type	Models NPN	Models PNP
	50 mm	2 m	LO	T8AN6D50	T8AP6D50
		3-Pin Pico Pigtail QD		T8AN6D50Q	T8AP6D50Q
		2 m	DO	T8RN6D50	T8RP6D50
		3-Pin Pico Pigtail QD		T8RN6D50Q	T8RP6D50Q
	100 mm	2 m	LO	T8AN6D100	T8AP6D100
		3-Pin Pico Pigtail QD		T8AN6D100Q	T8AP6D100Q
		2 m	DO	T8RN6D100	T8RP6D100
		3-Pin Pico Pigtail QD		T8RN6D100Q	T8RP6D100Q

Connection options: A model with a QD requires a mating cordset.

For 9 m cable, add suffix W/30 to the 2 m model number (example, T8AN6D50 W/30).



**Pico-Style**

Straight connector models listed; for right-angle, add **RA** to the end of the model number (example, **PKG3M-2RA**)

4-Pin	
<b>PKG3M-2</b>	<b>PKG3M-9</b>
2 m (6.5')	9 m (29.5')
<b>PKG3M-5</b>	<b>PKG3M-10</b>
5 m (16.4')	10 m (32.8')
<b>PKG3M-7</b>	
7 m (22.9')	



**SMB8MM**

Additional bracket information is available  
See page 723

Additional cordset information is available  
See page 758



Opposed and Diffuse Models  
Suffix E, R and D

T8 Specifications

Supply Voltage and Current	10 to 30 V dc (10% max. ripple) at less than 25 mA (exclusive of load)
Supply Protection Circuitry	Protected against reverse polarity and transient voltages
Output Configuration	Solid-state switch NPN (current sinking) or PNP (current sourcing), depending on model. Light Operate (LO) or Dark Operate (DO), depending on model
Output Rating	50 mA max. <b>OFF-state leakage current:</b> less than 1 $\mu$ A at 24 V dc <b>ON-state saturation voltage:</b> less than 0.25 V at 10 mA dc; less than 0.5 V at 50 mA dc
Output Protection Circuitry	Protected against false pulse on power-up and continuous overload or short circuit of outputs Overload trip point $\geq$ 100 mA
Output Response Time	1 millisecond ON; 0.5 milliseconds OFF
Delay at Power-up	Maximum 100 milliseconds (150 milliseconds for Diffuse); output does not conduct during this time
Repeatability	<b>Opposed:</b> 100 microseconds <b>Diffuse:</b> 160 microseconds
Indicators	<b>Opposed:</b> Receiver has Green and Red LED Emitter has one Green LED <b>Solid Green:</b> power ON <b>Solid Red:</b> light sensed <b>Flashing green:</b> output overloaded <b>Yellow flashing:</b> marginal excess gain <b>Diffuse:</b> <b>Red:</b> light is sensed
Construction	Reinforced polycarbonate/ABS alloy housing, acrylic window with 8 mm ABS nut
Environmental Rating	IEC IP67; NEMA 6
Operating Conditions	<b>Temperature:</b> -20° to +55° C <b>Relative humidity:</b> 80% at 50° C (non-condensing)
Vibration and Mechanical Shock	<b>Vibration:</b> All models meet IEC 60068-2-6, IEC 60947-5-2, UL491 Section 40, MIL-STD-202F Method 201A; 10 to 60 Hz, 0.5 mm peak to peak <b>Shock:</b> All models meet IEC 60068-2-27, IEC 60947-5-2; 30g peak acceleration, 11 millisecond pulse duration, half-sine wave pulse shape
Certifications	<b>CE</b>

# T18 Series

## Self-Contained Sensors



- Completely epoxy-encapsulated barrel-mount sensors
- Design rated NEMA 6P, IP67
- Wide operating range from -40° C to +70° C
- Advanced diagnostics warn of marginal sensing conditions or output overload
- Cordsets and brackets see page 104

### Opposed T18, 10-30 V DC

Infrared LED

Sensing Mode	Range	Connection	Models NPN	Models PNP
 OPPOSED	20 m	2 m	T186E Emitter	
		4-pin Euro QD	T186EQ Emitter	
		2 m	T18SN6R	T18SP6R
		4-pin Euro QD	T18SN6RQ	T18SP6RQ

### Retro & Polar Retro T18, 10-30 V DC

Infrared LED    Visible Red LED

Sensing Mode	Range	Connection	Models NPN	Models PNP
 RETRO	2 m†	2 m	T18SN6L	T18SP6L
		4-pin Euro QD	T18SN6LQ	T18SP6LQ
 POLAR RETRO	2 m†	2 m	T18SN6LP	T18SP6LP
		4-pin Euro QD	T18SN6LPQ	T18SP6LPQ

### Diffuse T18, 10-30 V DC

Infrared LED

Sensing Mode	Range	Connection	Models NPN	Models PNP
 DIFFUSE	500 mm	2 m	T18SN6D	T18SP6D
		4-pin Euro QD	T18SN6DQ	T18SP6DQ

### Fixed-Field T18, 10-30 V DC

Infrared LED

Sensing Mode	Range	Connection	Models NPN	Models PNP
 FIXED-FIELD	0 - 25 mm Cutoff	2 m	T18SN6FF25	T18SP6FF25
		4-pin Euro QD	T18SN6FF25Q	T18SP6FF25Q
 FIXED-FIELD	0 - 50 mm Cutoff	2 m	T18SN6FF50	T18SP6FF50
		4-pin Euro QD	T18SN6FF50Q	T18SP6FF50Q
 FIXED-FIELD	0 - 100 mm Cutoff	2 m	T18SN6FF100	T18SP6FF100
		4-pin Euro QD	T18SN6FF100Q	T18SP6FF100Q

For more specifications see page 105.

Connection options: A model with a QD requires a mating cordset (see page 104).

For 9 m cable, add suffix W/30 to the 2 m model number (example, T18SN6L W/30).

† Retroreflective range is specified using one model BRT-3 retroreflector. Actual sensing range may differ, depending on the efficiency and reflective area of the retroreflector used. See Accessories section for more information.

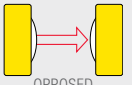

Opposed T18, 20-250 V AC

 Infrared LED

Sensing Mode	Range	Connection	Models LO	Models DO
 OPPOSED	20 m	2 m 4-pin Micro QD 2 m 4-pin Micro QD	T183E Emitter T183EQ1 Emitter T18AW3R T18AW3RQ1	T18RW3R T18RW3RQ1

Retro & Polar Retro T18, 20-250 V AC

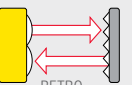
 Infrared LED  Visible Red LED

Sensing Mode	Range	Connection	Models LO	Models DO
 RETRO	2 m <sup>†</sup>	2 m 4-pin Micro QD	T18AW3L T18AW3LQ1	T18RW3L T18RW3LQ1
 POLAR RETRO	2 m <sup>†</sup>	2 m 4-pin Micro QD	T18AW3LP T18AW3LPQ1	T18RW3LP T18RW3LPQ1

Diffuse T18, 20-250 V AC

 Infrared LED

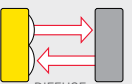
Sensing Mode	Range	Connection	Models LO	Models DO
 DIFFUSE	300 mm	2 m 4-pin Micro QD	T18AW3D T18AW3DQ1	T18RW3D T18RW3DQ1

T18, 20-250 V AC

 Infrared LED

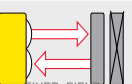
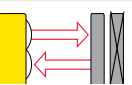
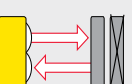
Sensing Mode	Range	Connection	Models LO	Models DO
 FIXED-FIELD	0 - 25 mm Cutoff	2 m 4-pin Micro QD	T18AW3FF25 T18AW3FF25Q1	T18RW3FF25 T18RW3FF25Q1
 FIXED-FIELD	0 - 50 mm Cutoff	2 m 4-pin Micro QD	T18AW3FF50 T18AW3FF50Q1	T18RW3FF50 T18RW3FF50Q1
 FIXED-FIELD	0 - 100 mm Cutoff	2 m 4-pin Micro QD	T18AW3FF100 T18AW3FF100Q1	T18RW3FF100 T18RW3FF100Q1

For more specifications see page 106.

 Connection options: A model with a QD requires a mating cordset (see page 104).

For 9 m cable, add suffix W/30 to the 2 m model number (example, T18SN6L W/30).

<sup>†</sup> Retroreflective range is specified using one model BRT-3 retroreflector. Actual sensing range may differ, depending on the efficiency and reflective area of the retroreflector used. See Accessories section for more information.



**Euro-Style**  
Straight connector models listed;  
for right-angle, add **RA** to the end  
of the model number (example,  
**MQDC-406RA**)

**4-Pin**  
**MQDC-406**  
2 m (6.5')  
**MQDC-415**  
5 m (15')  
**MQDC-430**  
9 m (30')



**Micro-Style**  
Straight connector models listed;  
for right-angle, add **RA** to the end  
of the model number (example,  
**MQDC-306RA**)

**4-Pin**  
**MQAC-406**  
2 m (6.5')  
**MQAC-415**  
5 m (15')  
**MQAC-430**  
9 m (30')

Additional cordset information is available  
See page 758



SMB18A



SMBAMS18P

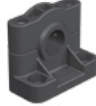

SMB1815SF



SMB18FM

Additional bracket information is available  
See page 723

**Reflectors**



Additional information is available  
See page 790

**Apertures**



Additional information is available  
See page 816



DC Sensors (all models)



AC Sensors (all models)



## T18 Specifications

<b>Supply Voltage and Current</b>	<p>T18 DC 10 to 30 V dc (10% max. ripple); Supply current (exclusive of load current):  <b>Opposed Emitters:</b> 25 mA                      <b>Opposed Receivers:</b> 20 mA  <b>Polarized Retroreflective:</b> 30 mA           <b>Non-polarized Retroreflective:</b> 25 mA  <b>Diffuse:</b> 25 mA                                      <b>Fixed-Field:</b> 35 mA</p> <p>T18AC 20 to 250 V ac (50/60 Hz)    <b>Average current:</b> 20 mA    <b>Peak current:</b> 200 mA at 20 V ac, 500 mA at 120 V ac, 750 mA at 250 V ac</p>
<b>Supply Protection Circuitry</b>	Protected against reverse polarity and transient voltages
<b>Output Configuration</b>	<p>T18 DC Solid-state complementary dc switch; NPN (current sinking) or PNP (current sourcing), depending on model. The Dark Operate (DO) output may be wired as a normally open marginal signal alarm output, depending upon hookup to the power supply.</p> <p>T18AC Solid-state ac switch; three-wire hookup; Light Operate (LO) or Dark Operate (DO), depending on model  <b>Light Operate:</b> Output conducts when the sensor sees its own (or the emitter's) modulated light  <b>Dark Operate:</b> Output conducts when sensor sees dark</p>
<b>Output Rating</b>	<p>T18 DC 150 mA max. (each) in standard hookup. When wired for alarm output, the total load may not exceed 150 mA.  <b>OFF-state leakage current:</b> less than 1 <math>\mu</math>A at 30 V dc  <b>ON-state saturation voltage:</b> less than 1 V at 10 mA dc; less than 1.5 V at 150 mA dc</p> <p>T18 AC 300 mA max. (continuous) <b>Fixed-Field:</b> derate 5 mA/<math>^{\circ}</math> C above +50<math>^{\circ}</math> C  <b>Inrush capability:</b> 1 amp for 20 milliseconds, non-repetitive  <b>OFF-state leakage current:</b> less than 100 <math>\mu</math>A  <b>ON-state voltage drop:</b> 3 V at 300 mA ac; 2 V at 15 mA ac</p>
<b>Output Protection Circuitry</b>	Protected against false pulse on power-up and continuous overload or short circuit of outputs
<b>Output Response Time</b>	<p>T18 DC <b>Opposed:</b> 3 milliseconds ON, 1.5 milliseconds OFF  <b>Polarized Retroreflective, Non-polarized Retroreflective, Fixed-Field and Diffuse:</b> 3 milliseconds ON/OFF</p> <p>T18 AC <b>Opposed:</b> 16 milliseconds ON, 8 milliseconds OFF  <b>Polarized Retroreflective, Non-polarized Retroreflective, Fixed-Field and Diffuse:</b> 16 milliseconds ON/OFF</p>
<b>Delay at Power-up</b>	100 milliseconds; outputs are non-conducting during this time
<b>Adjustments</b>	T18 Series infrared non-polarized retroreflective and diffuse mode models (only) have a single-turn SENSITIVITY control for adjustment of system gain
<b>Repeatability</b>	<p>T18 DC <b>Opposed:</b> 375 microseconds  <b>Polarized Retroreflective, Non-polarized Retroreflective, Fixed-Field and Diffuse:</b> 750 microseconds  Repeatability and response are independent of signal strength</p> <p>T18 AC <b>Opposed:</b> 2 milliseconds    <b>Polarized Retroreflective, Non-polarized Retroreflective, Fixed-Field and Diffuse:</b> 4 milliseconds  Repeatability and response are independent of signal strength.</p>
<b>Indicators</b>	<p><b>Two LEDs: Solid Green:</b> Power ON                      <b>Flashing Green:</b> output overloaded  <b>Solid Yellow:</b> Light Operate (LO) output energized    <b>Flashing Yellow:</b> marginal excess gain</p>
<b>Construction</b>	Housings are thermoplastic polyester. Lenses are polycarbonate or acrylic; one jam nut included.
<b>Environmental Rating</b>	Leakproof design rated NEMA 6P, IP67. QD models rated IP69K per DIN 40050-9
<b>Connections</b>	2 m or 9 m attached cable, or 4-pin Euro-style quick-disconnect fitting. QD cordsets are ordered separately. See page 104.
<b>Operating Conditions</b>	<b>Temperature:</b> -40 $^{\circ}$ to +70 $^{\circ}$ C <b>Relative humidity:</b> 90% at 50 $^{\circ}$ C (non-condensing)
<b>Vibration and Mechanical Shock</b>	All models meet Mil. Std. 202F requirements. Method 201A (Vibration; frequency 10 to 60 Hz, max., double amplitude 0.06-inch acceleration 10G). Method 213B conditions H&I (Shock: 75G with unit operating; 100G for non-operation)
<b>Certifications</b>	 <p>ECOLAB<sup>®</sup> chemical compatibility pending on some models; contact Banner Engineering for details</p>

# TM18 Series

## Heavy-Duty, Right Angle, Metal Sensors



- Robust die-cast metal sensors provide reliable sensing without adjustments
- Extremely bright LED red sensing beam for easy alignment
- Quick-disconnect models available
- Fixed-field models have enhanced immunity to fluorescent lights
- Polarized/fixed-field models have crosstalk avoidance so two sensors can be in close proximity
- Cordsets and brackets see page 90

### Opposed TM18

Sensing Mode	Range	Connection	Output Type	Models NPN	Models PNP
	20 m	2 m 4-pin Euro QD	—	TM186E Emitter TM186EQ8 Emitter	
		2 m 4-pin Euro QD	LO	TM18AN6R TM18AN6RQ8	TM18AP6R TM18AP6RQ8
		2 m 4-pin Euro QD	DO	TM18RN6R TM18RN6RQ8	TM18RP6R TM18RP6RQ8
		2 m 4-pin Euro QD	LO/DO	TM18VN6R TM18VN6RQ8	TM18VP6R TM18VP6RQ8

### Polar Retro TM18

Sensing Mode	Range	Connection	Output Type	Models NPN	Models PNP
	5.5 m†	2 m 4-pin Euro QD	LO	TM18AN6LP TM18AN6LPQ8	TM18AP6LP TM18AP6LPQ8
		2 m 4-pin Euro QD	DO	TM18RN6LP TM18RN6LPQ8	TM18RP6LP TM18RP6LPQ8
		2 m 4-pin Euro QD	LO/DO	TM18VN6LP TM18VN6LPQ8	TM18VP6LP TM18VP6LPQ8

For more specifications see page 109.

Connection options: A model with a QD requires a mating cordset (see page 108).

For 9 m cable, add suffix W/30 to the 2 m model number (example, TM186E W/30).

QD models: For a 4-pin 150 mm Euro-style pigtail QD, add suffix Q5 to the 2 m model number (example, TM186EQ5).

## Diffuse TM18

 Visible Red LED

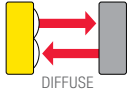
Sensing Mode	Range	Connection	Output Type	Models NPN	Models PNP
 DIFFUSE	500 mm	2 m 4-pin Euro QD	LO	TM18AN6DV TM18AN6DVQ8	TM18AP6DV TM18AP6DVQ8
		2 m 4-pin Euro QD	DO	TM18RN6DV TM18RN6DVQ8	TM18RP6DV TM18RP6DVQ8
		2 m 4-pin Euro QD	LO/DO	TM18VN6DV TM18VN6DVQ8	TM18VP6DV TM18VP6DVQ8

## Fixed-Field TM18

 Visible Red LED
  Infrared LED

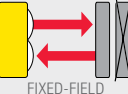
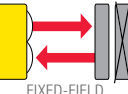
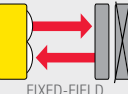
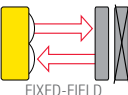
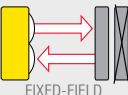
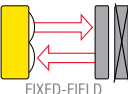
Sensing Mode	Range	Connection	Output Type	Models NPN	Models PNP
 FIXED-FIELD	25 mm	2 m 4-pin Euro QD	LO	TM18AN6FF25 TM18AN6FF25Q8	TM18AP6FF25 TM18AP6FF25Q8
		2 m 4-pin Euro QD	LO/DO	TM18VN6FF25 TM18VN6FF25Q8	TM18VP6FF25 TM18VP6FF25Q8
 FIXED-FIELD	50 mm	2 m 4-pin Euro QD	LO	TM18AN6FF50 TM18AN6FF50Q8	TM18AP6FF50 TM18AP6FF50Q8
		2 m 4-pin Euro QD	LO/DO	TM18VN6FF50 TM18VN6FF50Q8	TM18VP6FF50 TM18VP6FF50Q8
 FIXED-FIELD	100 mm	2 m 4-pin Euro QD	LO	TM18AN6FF100 TM18AN6FF100Q8	TM18AP6FF100 TM18AP6FF100Q8
		2 m 4-pin Euro QD	LO/DO	TM18VN6FF100 TM18VN6FF100Q8	TM18VP6FF100 TM18VP6FF100Q8
 FIXED-FIELD	25 mm	2 m 4-pin Euro QD	LO	TM18AN6FF25IR TM18AN6FF25IRQ8	TM18AP6FF25IR TM18AP6FF25IRQ8
		2 m 4-pin Euro QD	LO/DO	TM18VN6FF25IR TM18VN6FF25IRQ8	TM18VP6FF25IR TM18VP6FF25IRQ8
 FIXED-FIELD	50 mm	2 m 4-pin Euro QD	LO	TM18AN6FF50IR TM18AN6FF50IRQ8	TM18AP6FF50IR TM18AP6FF50IRQ8
		2 m 4-pin Euro QD	LO/DO	TM18VN6FF50IR TM18VN6FF50IRQ8	TM18VP6FF50IR TM18VP6FF50IRQ8
 FIXED-FIELD	100 mm	2 m 4-pin Euro QD	LO	TM18AN6FF100IR TM18AN6FF100IRQ8	TM18AP6FF100IR TM18AP6FF100IRQ8
		2 m 4-pin Euro QD	LO/DO	TM18VN6FF100IR TM18VN6FF100IRQ8	TM18VP6FF100IR TM18VP6FF100IRQ8

For more specifications see page 109.

 Connection options: A model with a QD requires a mating cordset (see page 108).

For 9 m cable, add suffix W/30 to the 2 m model number (example, TM18AP6FF25 W/30).

QD models: For a 4-pin 150 mm Euro-style pigtail QD, add suffix Q5 to the 2 m model number (example, TM18AP6FF25Q5).



4-Pin  
**MQDC-406**  
 2 m (6.5')  
**MQDC-415**  
 5 m (15')  
**MQDC-430**  
 9 m (30')

**Euro-Style**

Straight connector models listed; for right-angle, add **RA** to the end of the model number (example, **MQDC-406RA**)

Additional cordset information is available  
 See page 758



Opposed, Polar Retroreflective, Diffuse and Fixed-Field Models  
 Suffix E, R, LP, DV and FF



SMB18A



SMBAMS18P



SMBT18Y

Additional bracket information is available  
 See page 723

**Reflectors**





Additional information is available  
 See page 790

**Apertures**



Additional information is available  
 See page 816

## TM18 Specifications

Supply Voltage and Current	10 to 30 V dc (10% max. ripple within specified limits); supply current (exclusive of load current): <b>Opposed Emitters:</b> 25 mA <b>Opposed Receivers:</b> 20 mA <b>Polarized Retroreflector:</b> 20 mA <b>Diffuse and Fixed-Field:</b> 35 mA
Supply Protection Circuitry	Protected against reverse polarity and transient voltages
Output Configuration	Solid-state dc switch; NPN (current sinking) or PNP (current sourcing), depending on model <b>Light Operate:</b> Output conducts when sensor sees its own (or the emitter's) modulated light <b>Dark Operate:</b> Output conducts when sensor does not see its own (or the emitter's) modulated light
Output Rating	150 mA max. each output at 25° C, derated to 100 mA at 70° C (derate about 1 mA per °C) <b>OFF-state leakage current:</b> less than 1 µA @ 30 V dc <b>ON-state saturation voltage:</b> less than 1 V @ 10 mA dc; less than 1.5 V @ 150 mA dc
Output Protection Circuitry	Protected against false pulse on power-up and continuous overload or short circuit of outputs
Output Response Time	<b>Opposed:</b> 1.5 milliseconds ON, 0.75 milliseconds OFF <b>Polarized Retroreflective:</b> 1 milliseconds ON/OFF <b>Diffuse and Fixed-Field:</b> 3 milliseconds ON, 1.5 milliseconds OFF
Delay at Power-up	100 milliseconds Outputs do not conduct during this time
Repeatability	<b>Opposed:</b> 190 microseconds <b>Polarized Retroreflective:</b> 585 microseconds <b>Diffuse and Fixed-Field:</b> 185 microseconds
Adjustments	<b>Diffuse models only:</b> single turn rear panel sensitivity control
Indicators	4-wire <b>Two LEDs: Solid Green:</b> Power ON <b>Flashing Green:</b> output overloaded <b>Solid Yellow:</b> Output energized <b>Flashing Yellow:</b> marginal excess gain 3-wire <b>Two LEDs: Solid Green:</b> Power ON <b>Solid Yellow:</b> Output energized
Construction	<b>Housing:</b> Zinc die-cast with nickel plating <b>Lens:</b> PC or PMMA <b>Black Cover:</b> PBT polyester housing; polycarbonate (opposed mode) or acrylic lens
Environmental Rating	Leakproof design rated NEMA 6; IP67, IP69K QD models and cable models when PVC jacket is protected
Connections	2 m or 9 m attached cable, or 4-pin Euro-style integral or pigtail QD, depending on model. QD cordsets are ordered separately. See page 108.
Operating Conditions	<b>Temperature:</b> -40° to +70° C <b>Relative humidity:</b> 90% @ 50° C (non-condensing)
Vibration and Mechanical Shock	All models meet Mil. Std. 202F requirements. Method 201A (Vibration; frequency 10 to 60 Hz, max., double amplitude 0.06" acceleration 10G). Method 213B conditions H&I (Shock: 75G with unit operating; 100G for non-operation)
Certifications	 (class 2 supply required) 

# T30 Series

## Long-Range with Superior Durability



- Epoxy-encapsulated sensors provide reliable sensing without adjustments.
- Features 30 mm plastic threaded barrel
- Available in opposed, retroreflective and fixed-field modes
- Designed for use in harsh sensing environments
- Advanced diagnostics warn of marginal sensing conditions or output overload
- Cordsets and brackets see page 112

### Opposed T30, 10-30 V DC

Infrared LED

Sensing Mode	Range	Connection	Models NPN	Models PNP
 OPPOSED	60 m	2 m	T306E Emitter	
		4-Pin Euro QD	T306EQ Emitter	
		2 m	T30SN6R	T30SP6R
		4-Pin Euro QD	T30SN6RQ	T30SP6RQ

### Polar Retro T30, 10-30 V DC

Visible Red LED

Sensing Mode	Range	Connection	Models NPN	Models PNP
 POLAR RETRO	6 m <sup>†</sup>	2 m	T30SN6LP	T30SP6LP
		4-Pin Euro QD	T30SN6LPQ	T30SP6LPQ

### Fixed-Field T30, 10-30 V DC

Infrared LED

Sensing Mode	Range	Connection	Models NPN	Models PNP
 FIXED-FIELD	0 - 200 mm Cutoff	2 m	T30SN6FF200	T30SP6FF200
		4-Pin Euro QD	T30SN6FF200Q	T30SP6FF200Q
 FIXED-FIELD	0 - 400 mm Cutoff	2 m	T30SN6FF400	T30SP6FF400
		4-Pin Euro QD	T30SN6FF400Q	T30SP6FF400Q
 FIXED-FIELD	0 - 600 mm Cutoff	2 m	T30SN6FF600	T30SP6FF600
		4-Pin Euro QD	T30SN6FF600Q	T30SP6FF600Q

For more specifications see page 112.

Connection options: A model with a QD requires a mating cordset (see page 112).

For 9 m cable, add suffix W/30 to the 2 m model number (example, T30SN6LP W/30).

<sup>†</sup> Retroreflective range is specified using a BRT-3 retroreflector.

Actual sensing range may differ, depending on the efficiency and reflective area of the retroreflector used. See Accessories for more information.



Opposed T30, 20-250 V AC

 Infrared LED

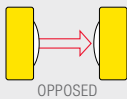
Sensing Mode	Range	Connection	Models Light Operate	Models Dark Operate
 OPPOSED	60 m	2 m	T303E Emitter	
		4-Pin Micro QD	T303EQ1 Emitter	
		2 m	T30AW3R	T30RW3R
		4-Pin Micro QD	T30AW3RQ1	T30RW3RQ1

Polar Retro T30, 20-250 V AC

 Visible Red LED

Sensing Mode	Range	Connection	Models Light Operate	Models Dark Operate
 POLAR RETRO	6 m†	2 m	T30AW3LP	T30RW3LP
		4-Pin Micro QD	T30AW3LPQ1	T30RW3LPQ1

Fixed-Field T30, 20-250 V AC

 Infrared LED

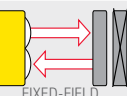
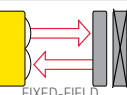
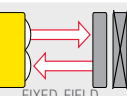
Sensing Mode	Range	Connection	Models Light Operate	Models Dark Operate
 FIXED-FIELD	0 - 200 mm Cutoff	2 m	T30AW3FF200	T30RW3FF200
		4-Pin Euro QD	T30AW3FF200Q1	T30RW3FF200Q1
 FIXED-FIELD	0 - 400 mm Cutoff	2 m	T30AW3FF400	T30RW3FF400
		4-Pin Euro QD	T30AW3FF400Q1	T30RW3FF400Q1
 FIXED-FIELD	0 - 600 mm Cutoff	2 m	T30AW3FF600	T30RW3FF600
		4-Pin Euro QD	T30AW3FF600Q1	T30RW3FF600Q1

For more specifications see page 112.

 Connection options: A model with a QD requires a mating cordset (see page 112).

For 9 m cable, add suffix W/30 to the 2 m model number (example, T30AW3LP W/30).

† Retroreflective range is specified using a BRT-3 retroreflector.

Actual sensing range may differ, depending on the efficiency and reflective area of the retroreflector used. See Accessories for more information.



**Euro-Style**  
Straight connector models listed; for right-angle, add **RA** to the end of the model number (example, **MQDC-406RA**)

**4-Pin**  
**MQDC-406**  
2 m (6.5')  
**MQDC-415**  
5 m (15')  
**MQDC-430**  
9 m (30')



**Micro-Style**  
Straight connector models listed; for right-angle, add **RA** to the end of the model number (example, **MQDC-306RA**)

**4-Pin**  
**MQAC-406**  
2 m (6.5')  
**MQAC-415**  
5 m (15')  
**MQAC-430**  
9 m (30')



**Opposed, Polarized Retroreflective and Fixed-field Models**  
Suffix E, R, LP and FF

Additional cordset information is available  
See page 758



SMB30A



SMBAMS30P

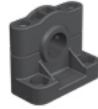

SMB1815SF



SMB30FA..

Additional bracket information is available  
See page 723

**Reflectors**



Additional information is available  
See page 790

**Apertures**



Additional information is available  
See page 816

T30 DC Specifications

<b>Supply Voltage and Current</b>	10 to 30 V dc (10% max. ripple); Supply current (exclusive of load current): <b>Opposed Emitters:</b> 25 mA <b>Opposed Receivers:</b> 20 mA <b>Polarized Retroreflective:</b> 30 mA <b>Fixed-Field:</b> 35 mA
<b>Supply Protection Circuitry</b>	Protected against reverse polarity and transient voltages
<b>Output Configuration</b>	Solid-state dc switch; three-wire hookup; choose Light Operate (LO) or Dark Operate (DO) models <b>Light Operate:</b> Output conducts when the sensor sees its own (or the emitter's) modulated light <b>Dark Operate:</b> Output conducts when sensor sees dark
<b>Output Rating</b>	150 mA max. (each) in standard hookup; When wired for alarm output, the total load may not exceed 150 mA <b>OFF-state leakage current:</b> less than 1 µA at 30 V dc <b>ON-state saturation voltage:</b> less than 1 V at 10 mA dc; less than 1.5 V at 150 mA dc
<b>Output Protection Circuitry</b>	Protected against false pulse on power-up and continuous overload or short circuit of outputs
<b>Output Response Time</b>	<b>Opposed:</b> 3 milliseconds ON; 1.5 milliseconds OFF <b>Polarized Retroreflective and Fixed-Field:</b> 3 milliseconds ON/OFF
<b>Delay at Power-up</b>	100 milliseconds; outputs are non-conducting during this time
<b>Repeatability</b>	<b>Opposed:</b> 375 microseconds <b>Polarized Retroreflective and Fixed-Field</b> 750 microseconds Repeatability and response are independent of signal strength.
<b>Indicators</b>	<b>Two LEDs:</b> <b>Solid Green:</b> Power ON <b>Flashing Green:</b> output overload <b>Solid Yellow:</b> Light operate (LO) output energized <b>Flashing Yellow:</b> marginal excess gain
<b>Construction</b>	Housings are thermoplastic polyester. Lenses are polycarbonate or acrylic; one jam nut included.
<b>Environmental Rating</b>	Leakproof design rated NEMA 6P, IP67. QD models rated IP69K per DIN 40050-9.
<b>Connections</b>	2 m or 9 m attached cable, or 4-pin Euro-style quick-disconnect fitting. QD cordsets are ordered separately. See page 112.
<b>Operating Conditions</b>	<b>Temperature:</b> -40° to +70° C <b>Relative humidity:</b> 90% at 50° C (non-condensing)
<b>Vibration and Mechanical Shock</b>	All models meet Mil. Std. 202F requirements. Method 201A (Vibration; frequency 10 to 60 Hz, max., double amplitude 0.06-inch acceleration 10G). Method 213B conditions H&I (Shock: 75G with unit operating; 100G for non-operation)

Certifications



ECOLAB® chemical compatibility pending on some models; contact Banner Engineering for details

## T30 AC Specifications

Supply Voltage and Current	20 to 250 V ac (50/60 Hz). <b>Average current:</b> 20 mA <b>Peak current:</b> 200 mA at 20 V ac, 500 mA at 120 V ac, 750 mA at 250 V ac
Supply Protection Circuitry	Protected against transient voltages
Output Configuration	Solid-state ac switch; three-wire hookup; choose Light Operate (LO) or Dark Operate (DO) models <b>Light Operate:</b> Output conducts when the sensor sees its own (or the emitter's) modulated light <b>Dark Operate:</b> Output conducts when sensor sees dark
Output Rating	300 mA max. (continuous) <b>Fixed-Field:</b> derate 5 mA/° C above +50° C <b>Inrush capability:</b> 1 amp for 20 milliseconds, non-repetitive <b>OFF-state leakage current:</b> less than 100 µA <b>ON-state voltage drop:</b> 3 V at 300 mA ac; 2 V at 15 mA ac
Output Protection Circuitry	Protected against false pulse on power-up
Output Response Time	<b>Opposed:</b> 16 milliseconds ON; 8 milliseconds OFF <b>Polarized Retroreflective and Fixed-Field:</b> 16 milliseconds ON/OFF
Delay at Power-up	100 milliseconds
Repeatability	<b>Opposed:</b> 2 milliseconds <b>Polarized Retroreflective and Fixed-Field:</b> 4 milliseconds Repeatability and response are independent of signal strength
Indicators	<b>Two LEDs:</b> <b>Solid Green:</b> Power ON <b>Solid Yellow:</b> Light sensed <b>Flashing Yellow:</b> marginal excess gain
Construction	Housings are thermoplastic polyester. Lenses are polycarbonate or acrylic; one jam nut included.
Environmental Rating	Leakproof design rated NEMA 6P, IP67. QD models rated IP69K per DIN 40050-9.
Connections	2 m or 9 m attached cable, or 4-pin Micro-style quick-disconnect fitting. QD cordsets are ordered separately. See page 112.
Operating Conditions	<b>Temperature:</b> -40° to +70° C <b>Relative humidity:</b> 90% at 50° C (non-condensing)
Vibration and Mechanical Shock	All models meet Mil. Std. 202F requirements. Method 201A (Vibration; frequency 10 to 60 Hz, max, double amplitude 0.06-inch acceleration 10G). Method 213B conditions H&I (Shock: 75G with unit operating; 100G for non-operation)
Certifications	



---

## Barrel Sensors

Barrel sensors are available in industry standard 12, 18 and 30 mm barrel mounting options. The compact barrel size allows for easy replacement and easy viewing of LED indicators.

Series	Description	Max Sensing Range	Dimensions H x W x D	Protection Rating	Housing Material	Power Supply
	<b>M12</b> Rugged, threaded metal sensor with fully encapsulated electronics. Page 116	<b>Opposed:</b> 5 m <b>Retro:</b> 2.5 m <b>Polarized Retro:</b> 1.5 m <b>Diffuse:</b> 400 mm <b>Fixed-Field:</b> 75 mm	12 ø x 67.5 mm	IEC IP67; NEMA 6, IEC IP68 and 1200 PSI washdown	Nickel-plated brass	10 to 30 V dc
	<b>S12-2/S12</b> Barrel sensors provide reliable sensing without adjustments. Page 118	<b>Opposed:</b> 20 m	<b>S12-2:</b> 30.4 x ø 12 mm <b>S12:</b> 64 x ø 12 mm	IEC IP67; NEMA 6	Thermoplastic Polyester	10 to 30 V dc
	<b>SB12/SB12T</b> Economical sensors provide reliable sensing without adjustments. Page 120	<b>Opposed:</b> 1.5 m	<b>SB12:</b> 15.8 ø x 31 mm <b>SB12T:</b> 15.8 ø x 30.4 mm	IEC IP67; NEMA 6	Thermoplastic Polyester	10 to 30 V dc
	<b>S18</b> Epoxy-encapsulated barrel sensors operate on dc voltage and provide reliable sensing without adjustments. Page 124	<b>Opposed:</b> 20 m <b>Retro:</b> 2 m <b>Polarized Retro:</b> 2 m <b>Diffuse:</b> 300 mm <b>Fixed-Field:</b> 100 mm	ø 18 x 58.8 mm	<b>QD models:</b> IP69K <b>Other models:</b> IEC IP67; NEMA 6	Thermoplastic Polyester	10 to 30 V dc 20 to 250 V ac
	<b>S18-2</b> A self-contained powerful sensor with bright visible red emitter beam for easy alignment and set-up. Page 122	<b>Opposed:</b> 25 m <b>Polarized Retro:</b> 6m <b>Retro:</b> 7.5 m <b>Diffuse:</b> 750 mm <b>Fixed-Field:</b> 200 mm	Varies by model	IEC IP67; NEMA 6	Thermoplastic Polyester	10 to 30 V dc
	<b>M18</b> Epoxy-encapsulated metal barrel sensors provide reliable sensing without adjustments. Page 126	<b>Opposed:</b> 20 m <b>Retro:</b> 2 m <b>Polarized Retro:</b> 2 m <b>Diffuse:</b> 300 mm <b>Fixed-Field:</b> 100 mm	18 ø x 59.2 mm	<b>QD models:</b> IP69K <b>Other models:</b> IEC IP67; NEMA 6	Stainless steel	10 to 30 V dc
	<b>M18-3</b> Nickel plated brass housing is well protected against industrial fluids and mechanical damage. Page 128	<b>Opposed:</b> 25 m <b>Retro:</b> 6 m <b>Polarized Retro:</b> 7.5 m <b>Diffuse:</b> 750 mm <b>Fixed-Field:</b> 200 mm	18 ø x 63.5 mm	IEC IP67 and IP69K	Nickel-plated	10 to 30 V dc
	<b>M18-4</b> Epoxy-encapsulated metal barrel sensors provide reliable sensing without adjustments. Page 130	<b>Opposed:</b> 25 m <b>Retro:</b> 6 m <b>Polarized Retro:</b> 7.5 m <b>Diffuse:</b> 750 mm <b>Fixed-Field:</b> 200 mm	18 ø x 63.5 mm	IEC IP67, IP68 and IP69K	Stainless steel	10 to 30 V dc
	<b>S30</b> Epoxy-encapsulated sensors provide superior durability and reliable sensing over a long range. Page 138	<b>Opposed:</b> 60 m <b>Polarized Retro:</b> 6 m <b>Fixed-Field:</b> 600 mm	Varies by model	<b>QD models:</b> IP69K <b>Other models:</b> IEC IP67; NEMA 6	Thermoplastic Polyester	10 to 30 V dc 20 to 250 V ac
	<b>SM30</b> Powerful epoxy-encapsulated sensor with a long range and the stainless steel model can be used in abusive environments. Page 140	<b>Opposed:</b> 150 m	30 ø x 102 mm	IEC IP67; NEMA 6	Thermoplastic Polyester or Stainless steel	10 to 30 V dc 24 to 240 V ac

# M12 Series

## Metal Barrel-Mount Sensors



- Metal sensor with fully encapsulated electronics.
- Easily replaces inductive sensors when target is too close to the sensor
- Available in NEMA 6P, IP67, IP69K and up to 1200 psi washdown depending on model
- Highly visible red sensing beam for easy alignment

### Opposed M12

Sensing Mode	Range	Connection	Models NPN	Models PNP
 OPPOSED	5 m	2 m 4-Pin Euro QD	M12E (Emitter)	
	5 m	2 m 4-Pin Euro QD	M12NR M12NRQ8	M12PR M12PRQ8
			M12EQ8 (Emitter)	

### Retro & Polar Retro M12

Sensing Mode	Range	Connection	Models NPN	Models PNP
 RETRO	2.5 m <sup>†</sup>	2 m	M12NLV	M12PLV
		4-Pin Euro QD	M12NLVQ8	M12PLVQ8
 POLAR RETRO	1.5 m <sup>†</sup>	2 m	M12NLP	M12PLP
		4-Pin Euro QD	M12NLPQ8	M12PLPQ8

### Fixed-Field M12

Sensing Mode	Range	Connection	Models NPN	Models PNP
 FIXED-FIELD	25 mm Cutoff	2 m	M12NFF25	M12PFF25
		4-Pin Euro QD	M12NFF25Q8	M12PFF25Q8
 FIXED-FIELD	50 mm Cutoff	2 m	M12NFF50	M12PFF50
		4-Pin Euro QD	M12NFF50Q8	M12PFF50Q8
 FIXED-FIELD	75 mm Cutoff	2 m	M12NFF75	M12PFF75
		4-Pin Euro QD	M12NFF75Q8	M12PFF75Q8

Connection options: A model with a QD requires a mating cordset.

For 9 m cable, add suffix W/30 to the 2 m model number (example, M12PD W/30).

QD models: For a 4-pin 150 mm Euro-style pigtail QD, add suffix Q5 (example, M12PDQ5).

<sup>†</sup> Retroreflective range is specified using a BRT-84 retroreflector.

Actual sensing range may differ, depending on the efficiency and reflective area of the retroreflector used. See Accessories for more information.



Diffuse M12

→ Visible Red LED

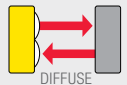
Sensing Mode	Range	Connection	Models NPN	Models PNP
	400 mm	2 m	M12ND	M12PD
		4-Pin Euro QD	M12NDQ8	M12PDQ8

**Euro QD (for Q5 models)**  
Straight connector models listed; for right-angle, add **RA** to the end of the model number (example, **MQDC-406RA**)



**4-Pin**  
**MQDC-406**  
2 m (6.')

**MQDC-415**  
5 m (15')

**MQDC-430**  
9 m (30')



**SMBQS12PD**  
12-ga. stainless steel

Additional bracket information is available  
See page 758

Additional bracket information is available  
See page 723



Opposed, Retroreflective  
Diffuse and Fixed-Field Models  
Suffix E, R, LP, LV, D and FF

Reflectors



Additional information is available  
See page 790

Apertures



Additional information is available  
See page 816

M12 Specifications

Sensing Beam	<b>Fixed-Field:</b> 680 nm visible red <b>All others:</b> 660 nm visible red
Supply Voltage and Current	10 to 30 V dc (10% max. ripple) @ 20 mA max current (exclusive of load)
Supply Protection Circuitry	Protected against reverse polarity and transient voltages
Output Configuration	Complementary (1 normally open and 1 normally closed) solid-state, NPN or PNP, depending on model
Output Ratings	100 mA total across both outputs with overload and short circuit protection <b>OFF-state leakage current:</b> <b>NPN:</b> less than 200 µA @ 30 V dc (see Application Note) <b>PNP:</b> less than 10 µA @ 30 V dc <b>ON-state saturation voltage:</b> <b>NPN:</b> less than 1.6 V @ 100 mA <b>PNP:</b> less than 3.0 V @ 100 mA
Output Protection Circuitry	Protected against false pulse on power-up, short-circuit protected
Output Response Time	<b>Opposed:</b> 625 microsecond ON/375 microseconds OFF <b>All others:</b> 500 microseconds ON/OFF
Delay at Power-up	100 milliseconds; outputs do not conduct during this time
Repeatability	<b>Opposed:</b> 85 microseconds <b>All others:</b> 95 microseconds
Indicators	<b>2 LED indicators:</b> <b>Solid Green:</b> power ON <b>Flashing Green:</b> output overloaded <b>Yellow:</b> light sensed <b>Flashing Yellow:</b> marginal excess gain
Adjustments	<b>Fixed-Field:</b> none <b>All others:</b> single-turn Gain (sensitivity) potentiometer
Construction	<b>Housing:</b> Nickel-plated brass <b>Lenses:</b> PMMA <b>Cable endcap and Gain potentiometer adjuster:</b> PBT
Environmental Rating	IEC IP67; NEMA 6, IEC IP68 and 1200 PSI washdown, NEMA 1CS 5 Annex F-2002
Connections	2 m or 9 m 4-wire PVC-jacketed cable, 4-pin integral Euro-style QD ( <b>Q8</b> ), or 150 mm pigtail with 4-pin Euro-style quick-disconnect fitting ( <b>Q5</b> ), depending on model. QD cordsets ordered separately.
Operating Conditions	<b>Operating temperature:</b> -20° to +60° C <b>Relative humidity:</b> 90% max @ +50° C
Application Notes	NPN off-state leakage current is < 200 µA for load resistances > 3 kΩ or optically isolated loads. For load current of 100 mA, leakage is < 1% of load current

Certifications



# S12 Series

## Plastic Barrel-Mount Sensors



- Housing rated to IP67 for heavy-duty industrial sensing
- Sensing range up to 20 m
- Wide beam pattern makes sensor alignment easy at long ranges
- Available in opposed mode

### Opposed S12

➔ Visible Red LED

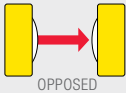
Sensing Mode	Range	Connection	Models NPN	Models PNP
	15 m	2 m	S126E Emitter	
			S12SN6R	S12SP6R

### Opposed S12-2

➔ Infrared LED

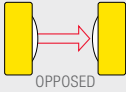
Sensing Mode	Range	Input	Connection	Models NPN	Models PNP
	20 m	–	2 m	S12-2NAEL-2M Emitter	
		Beam Inhibit		S12-2NAEJ-2M Emitter	
		–		S12-2ANRL-2M	S12-2APRL-2M
		–		S12-2RNRL-2M	S12-2RPRL-2M

 Connection options: A model with a QD requires a mating cordset.  
 QD models: For a 4-pin 150 mm Pico-style pigtail QD, add suffix QP (example, S12SN6RQP).



**Pico QD (for Q models)**  
Straight connector models listed; for right-angle, **W** replaces **G** in the model number.  
(example, **PKW4M-2**)

**4-Pin**  
**PKG4M-2**  
2 m (6')  
**PKG4M-5**  
5 m (15')  
**PKG4M-9**  
9 m (30')



**Pico QD (for Q7 models)**  
Straight snap-on connector model  
**Pico QD (for Q7 models)**  
Right Angle' snap-on connector model

**4-Pin**  
**PKG4-2**  
2 m (6')  
**PKW4Z-2**  
2 m (6')

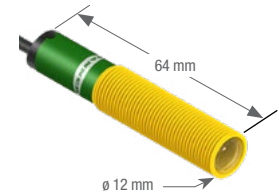

**S12**  
Opposed Models

Additional cordset information is available  
See page 758



**SMB12MM**

Additional bracket information is available  
See page 723

**Reflectors**



Additional information is available  
See page 790

**Apertures**



Additional information is available  
See page 816



**S12-2**  
Opposed Models

**S12 & S12-2 Specifications**

<b>Supply Voltage and Current</b>	<b>S12:</b> 10 to 30 V dc (10% max. ripple); 25 mA (emitters) or 20 mA (receivers) exclusive of load <b>S12-2:</b> 10 to 30 V dc; < 25 mA (emitters) or 15 mA (receivers) exclusive of load
<b>Supply Protection Circuitry</b>	Protected against reverse polarity and transient voltages
<b>Output Configuration</b>	<b>S12:</b> Complementary solid-state dc switch; choose NPN (current sinking) or PNP (current sourcing) models <b>Light Operate:</b> N.O. output conducts when the sensor sees the emitter's modulated light <b>Dark Operate:</b> N.C. output conducts when the sensor sees dark; The N.C. (normally closed) output may be wired as a normally open marginal signal alarm output, depending upon hookup to the power supply <b>S12-2:</b> One solid state output, NPN (sinking) or PNP (sourcing), depending on model
<b>Output Ratings</b>	100 mA maximum (each) in standard hookup; when wired for alarm output, the total load may not exceed 100 mA <b>OFF-state leakage current:</b> less than 1 µA @ 30 V dc <b>ON-state saturation voltage:</b> less than 1 V @ 10 mA; less than 1.5 V @ 150 mA
<b>Output Protection Circuitry</b>	Protected against false pulse on power-up and continuous overload or short circuit of outputs
<b>Output Response Time</b>	<b>S12:</b> 3 milliseconds ON, 1.5 milliseconds OFF <b>S12-2:</b> 11 milliseconds ON, 7 milliseconds OFF
<b>Delay at Power-up</b>	<b>S12:</b> 100 millisecond; outputs are non-conducting during this time <b>S12-2:</b> 1 second; outputs are non-conducting during this time
<b>Repeatability</b>	<b>S12:</b> 375 microseconds <b>S12-2:</b> 1.5 milliseconds
<b>Indicators</b>	<b>Green LED (emitter and receiver):</b> power ON <b>Amber LED (receiver only):</b> light sensed
<b>Construction</b>	Housings are reinforced thermoplastic polyester; lenses are Lexan®; Polyurethane end cap
<b>Environmental Rating</b>	Leakproof design rated NEMA 6P (IEC IP67)
<b>Connections</b>	<b>S12:</b> 2 m or 9 m cable, or a 150 mm pigtail with 4-pin Pico-style QD <b>S12-2:</b> 2 m or 9 m cable, or a 150 mm pigtail with 3-pin Pico-style QD QD cordset ordered separately.
<b>Operating Conditions</b>	<b>S12:</b> Temperature: -40° to +70° C Maximum relative humidity: 90% at 50°C (non-condensing) <b>S12-2:</b> Temperature: -25° to +50° C Maximum relative humidity: 90% at 50°C (non-condensing)
<b>Vibration and Mechanical Shock</b>	Meets Mil. Std. 202F requirements. Method 201A (Vibration: frequency 10 to 60 Hz, max., double amplitude 0.06-inch acceleration 10G). Method 213B conditions H&I (Shock: 75G with unit operating; 100G for non-operation).
<b>Certifications</b>	

Lexan® is a registered trademark of General Electric Co.

# SB12 & SB12T

## Plastic Barrel-Mount Sensors



- Narrow beam for precise leading edge detection
- Ideal for compact areas
- No adjustment necessary
- SB12T has a threaded housing for robust monitoring in applications with vibration, rough handling or vandalism

### Opposed SB12

Infrared LED

Sensing Mode	Range	Connection	Output	Models NPN	Models PNP
OPPOSED	1.5 m	2 m	- LO DO	SB12E1 Emitter	
				SB12ANR	SB12APR
				SB12RNR	SB12RPR

### Opposed SB12T

Infrared LED

Sensing Mode	Range	Connection	Output	Models NPN	Models PNP
OPPOSED	1.5 m	2 m	- LO DO	SB12TE1 Emitter	
				SB12TANR	SB12TAPR
				SB12TRNR	SB12TRPR

Connection options: A model with a QD requires a mating cordset  
 QD models: For a 3-pin 150 mm Pico-style pigtail QD, add suffix Q3 (example, SB12E1Q3).



4-Pin

**Pico QD (for Q models)**  
Straight connector models listed; for right-angle, **W** replaces **G** in the model number.  
(example, **PKW4M-2**)

**PKG4M-2**  
2 m (6')  
**PKG4M-5**  
5 m (15')  
**PKG4M-9**  
9 m (30')



4-Pin

**Pico QD (for Q7 models)**  
Straight snap-on connector model  
**Pico QD (for Q7 models)**  
Right Angle snap-on connector model

**PKG4-2**  
2 m (6')  
**PKW4Z-2**  
2 m (6')

Additional cordset information is available  
See page 758



SMB12MM

Additional bracket information is available  
See page 723



SB12  
Opposed Models



SB12T  
Opposed Models

### SB12/SB12T Specifications

Supply Voltage and Current	10 to 30 V dc; less than 15 mA max exclusive of load	
Supply Protection Circuitry	Protected against reverse polarity and transient voltages	
Output Configuration	One solid state output, NPN (sinking) or PNP (sourcing), depending on model	
Output Ratings	<b>SB12/SB12T:</b> 100 mA <b>OFF-state leakage current:</b> < 10 µA <b>ON-state saturation voltage:</b> < 0.2 V @ 10 mA; < 0.6 V @ 100 mA	
Output Protection Circuitry	Protected against false pulse on power-up and continuous overload or short circuit of outputs	
Output Response Time	2.5 milliseconds ON, 1.75 milliseconds OFF	
Delay at Power-up	Less than 1 second	
Repeatability	350 microseconds	
Switching Frequency	235 Hz	
Indicators	<b>Solid Green (emitter and receiver):</b> power ON <b>Solid Amber (receiver only):</b> light sensed	<b>Flashing Green (emitter and receiver):</b> output short circuited <b>Flashing Amber (receiver only):</b> marginal excess gain
Construction	<b>Housing:</b> ABS <b>Lens:</b> Polycarbonate; epoxy encapsulant <b>Cable:</b> PVC-jacketed	
Environmental Rating	<b>SB12:</b> IP65	<b>SB12T:</b> IP67
Connections	2 m cable or 150 mm pigtail with 3-pin Pico-style QD. QD cordset ordered separately.	
Operating Conditions	<b>Temperature:</b> -20° to +50° C <b>Maximum relative humidity:</b> 90% at 50° C (non-condensing)	

Certifications



# S18-2 Series

## Plastic Barrel-Mount Sensors



- Bright visible red emitter beam for easy alignment and set-up
- Available in multiple operating modes
- Wide operating range from -40° C to +70° C
- High performance sensing
- Beam inhibit or gain adjustment on select models
- Cordsets and brackets see page 132

### Opposed S18-2



Sensing Mode	Range	Connection	Models NPN	Models PNP
<p>OPPOSED</p>	25 m	Emitter	2 m	S18-2NAEL-2M
			4-pin Euro QD	S18-2NAEL-Q8
			2 m	S18-2NAEJ-2M (with Beam inhibit)
			4-pin Euro QD	S18-2NAEJ-Q8 (with Beam inhibit)
			2 m	S18-2NAES-2M (with Adjustment)
			4-pin Euro QD	S18-2NAEJ-Q8 (with Adjustment)
<p>OPPOSED</p>	25 m	Receiver	2 m	S18-2VNLP-2M
			4-pin Euro QD	S18-2VNLP-Q8
			2 m	M18-3VNRS-2M (with Adjustment)
			4-pin Euro QD	M18-3VNRS-Q8 (with Adjustment)
				S18-2VPLP-2M
				S18-2VPLP-Q8
				M18-3VPRS-2M (with Adjustment)
				M18-3VPRS-Q8 (with Adjustment)

### Polar Retro S18-2



Sensing Mode	Range*	Connection	Models NPN	Models PNP
<p>POLAR RETRO</p>	6 m	2 m	S18-2VNLP-2M	S18-2VPLP-2M
		4-pin Euro QD	S18-2VNLP-Q8	S18-2VPLP-Q8
		2 m	S18-2VNLPC-2M (with Adjustment)	S18-2VPLPC-2M (with Adjustment)
		4-pin Euro QD	S18-2VNLPC-Q8 (with Adjustment)	S18-2VPLPC-Q8 (with Adjustment)

For more specifications see page 133.

Connection options: A model with a QD requires a mating cordset (see page 132).  
 For a 9 m cable, add suffix 9M to the 2 m model number (example, S18-2NAEL-9M).  
 For a 4-pin Euro M12 pigtail QD, add suffix Q5 to the model number (example, S18-2VNRL-Q5)  
 For a 4-pin Pico M8 pigtail QD, add suffix Q3 to the model number (example, S18-2VNRL-Q3)  
 \* Range specified with BRT-84 reflector



## Retro S18-2

 Visible Red LED

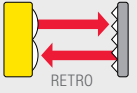
Sensing Mode	Range*	Connection	Models NPN	Models PNP
	7.5 m	2 m	S18-2VNLV-2M (with Adjustment)	S18-2VPLV-2M (with Adjustment)
		4-pin Euro QD	S18-2VNLV-Q8 (with Adjustment)	S18-2VPLV-Q8 (with Adjustment)

## Diffuse S18-2

 Visible Red LED

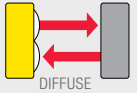
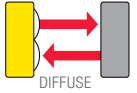
Sensing Mode	Range*	Connection	Models NPN	Models PNP
	750 mm	2 m	S18-2VNLD-2M (with Adjustment)	S18-2VPDL-2M (with Adjustment)
		4-pin Euro QD	S18-2VNLD-Q8 (with Adjustment)	S18-2VPDL-Q8 (with Adjustment)
	300 mm	2 m	S18-2VNDS-2M (with Adjustment)	S18-2VPDS-2M (with Adjustment)
		4-pin Euro QD	S18-2VNDS-Q8 (with Adjustment)	S18-2VPDS-Q8 (with Adjustment)

## Fixed-Field S18-2

 Visible Red LED

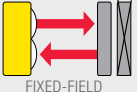
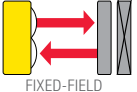
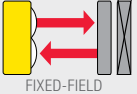
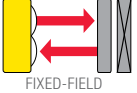
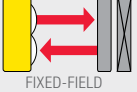
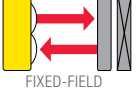
Sensing Mode	Range*	Connection	Models NPN	Models PNP
	30 mm	2 m	S18-2VNFF30-2M	S18-2VPFF30-2M
		4-pin Euro QD	S18-2VNFF30-Q8	S18-2VPFF30-Q8
	50 mm	2 m	S18-2VNFF50-2M	S18-2VPFF50-2M
		4-pin Euro QD	S18-2VNFF50-Q8	S18-2VPFF50-Q8
	75 mm	2 m	S18-2VNFF75-2M	S18-2VPFF75-2M
		4-pin Euro QD	S18-2VNFF75-Q8	S18-2VPFF75-Q8
	100 mm	2 m	S18-2VNFF100-2M	S18-2VPFF100-2M
		4-pin Euro QD	S18-2VNFF100-Q8	S18-2VPFF100-Q8
	150 mm	2 m	S18-2VNFF150-2M	S18-2VPFF150-2M
		4-pin Euro QD	S18-2VNFF150-Q8	S18-2VPFF150-Q8
	200 mm	2 m	S18-2VNFF200-2M	S18-2VPFF200-2M
		4-pin Euro QD	S18-2VNFF200-Q8	S18-2VPFF200-Q8

For more specifications see page 133.

 Connection options: A model with a QD requires a mating cordset (see page 132).

For a 9 m cable, add suffix 9M to the 2 m model number (example, S18-2NAEL-9M).

For a 4-pin Euro M12 pigtail QD, add suffix Q5 to the model number (example, S18-2VNRL-Q5)

For a 4-pin Pico M8 pigtail QD, add suffix Q3 to the model number (example, S18-2VNRL-Q3)

\* Range specified with BRT-84 reflector

# S18 Series

## Plastic Barrel-Mount Sensors

- Epoxy-encapsulated barrel sensors
- Available in multiple operating modes
- Meets IP69K standards
- Wide operating range from -40° C to +70° C
- Cordsets and brackets see page 132

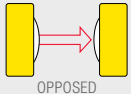

### Opposed S18, 10-30 V DC

 Infrared LED

Sensing Mode	Range	Connection	Models NPN	Models PNP
 OPPOSED	20 m	2 m	S18SN6R S18SN6RQ	S186E Emitter S186EQ Emitter S18SP6R S18SP6RQ
		4-pin Euro QD		
		2 m		
		4-pin Euro QD		

### Retro and Polar Retro S18, 10-30 V DC

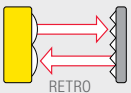
 Infrared LED
  Visible Red LED

Sensing Mode	Range	Connection	Models NPN	Models PNP
 RETRO	2 m*	2 m	S18SN6L	S18SP6L
		4-pin Euro QD	S18SN6LQ	S18SP6LQ
 POLAR RETRO	2 m*	2 m	S18SN6LP	S18SP6LP
		4-pin Euro QD	S18SN6LPQ	S18SP6LPQ

### Diffuse S18, 10-30 V DC

 Infrared LED

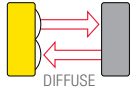
Sensing Mode	Range	Connection	Models NPN	Models PNP
 DIFFUSE	100 mm	2 m	S18SN6D	S18SP6D
		4-pin Euro QD	S18SN6DQ	S18SP6DQ
	300 mm	2 m	S18SN6DL	S18SP6DL
		4-pin Euro QD	S18SN6DLQ	S18SP6DLQ

### Fixed-Field S18, 10-30 V DC

 Infrared LED

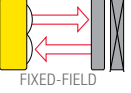
Sensing Mode	Range	Connection	Models NPN	Models PNP
 FIXED-FIELD	0 - 25 mm Cutoff	2 m	S18SN6FF25	S18SP6FF25
		4-pin Euro QD	S18SN6FF25Q	S18SP6FF25Q
	0 - 50 mm Cutoff	2 m	S18SN6FF50	S18SP6FF50
		4-pin Euro QD	S18SN6FF50Q	S18SP6FF50Q
	0 - 100 mm Cutoff	2 m	S18SN6FF100	S18SP6FF100
		4-pin Euro QD	S18SN6FF100Q	S18SP6FF100Q

For more specifications see page 133.

 Connection options: A model with a QD requires a mating cordset (see page 132).

For 9 m cable, add suffix W/30 to the 2 m model number (example, S18SP6R W/30).

\* Retroreflective range is specified using one model BRT-3 retroreflector, unless otherwise noted.

Actual sensing range may differ, depending on the efficiency and reflective area of the retroreflector used. See Accessories section for more information.

Opposed S18, 20-250 V AC

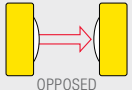

 Infrared LED

Sensing Mode	Range	Connection	Models Light Operate	Models Dark Operate
 <p>OPPOSED</p>	20 m	2 m	S183E Emitter	
		4-pin Micro QD	S183EQ1 Emitter	
		2 m	S18AW3R	S18RW3R
		4-pin Micro QD	S18AW3RQ1	S18RW3RQ1

Retro & Polar Retro S18, 20-250 V AC

 Infrared LED

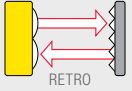
 Visible Red LED

Sensing Mode	Range	Connection	Models Light Operate	Models Dark Operate
 <p>RETRO</p>	2 m†	2 m	S18AW3L	S18RW3L
		4-pin Micro QD	S18AW3LQ1	S18RW3LQ1
 <p>POLAR RETRO</p>	2 m†	2 m	S18AW3LP	S18RW3LP
		4-pin Micro QD	S18AW3LPQ1	S18RW3LPQ1

Diffuse S18, 20-250 V AC

 Infrared LED

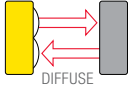
Sensing Mode	Range	Connection	Models Light Operate	Models Dark Operate
 <p>DIFFUSE</p>	100 mm	2 m	S18AW3D	S18RW3D
		4-pin Micro QD	S18AW3DQ1	S18RW3DQ1
	300 mm	2 m	S18AW3DL	S18RW3DL
		4-pin Micro QD	S18AW3DLQ1	S18RW3DLQ1

Fixed-Field S18, 20-250 V AC

 Infrared LED

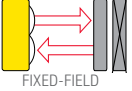
Sensing Mode	Range	Connection	Models Light Operate	Models Dark Operate
 <p>FIXED-FIELD</p>	0 - 25 mm Cutoff	2 m	S18AW3FF25	S18RW3FF25
		4-pin Micro QD	S18AW3FF25Q1	S18RW3FF25Q1
	0 - 50 mm Cutoff	2 m	S18AW3FF50	S18RW3FF50
		4-pin Micro QD	S18AW3FF50Q1	S18RW3FF50Q1
	0 - 100 mm Cutoff	2 m	S18AW3FF100	S18RW3FF100
		4-pin Micro QD	S18AW3FF100Q1	S18RW3FF100Q1

For more specifications see page 134.

 Connection options: A model with a QD requires a mating cordset (see page 132).  
 For 9 m cable, add suffix W/30 to the 2 m model number (example, S183E W/30).  
 † Retroreflective range is specified using one model BRT-3 retroreflector, unless otherwise noted.  
 Actual sensing range may differ, depending on the efficiency and reflective area of the retroreflector used. See Accessories section for more information.

# M18 Series

## Metal Barrel-Mount Sensors



- Epoxy-encapsulated metal barrel sensors
- Available in multiple operating modes
- Meets IP69K standards
- Wide operating range from -40 to +70° C
- High performance sensing
- Cordsets and brackets see page 132

### Opposed M18

Infrared LED

Sensing Mode	Range	Connection	Models NPN	Models PNP
 OPPOSED	20 m	2 m	M186E Emitter	
		4-pin Euro QD	M186EQ Emitter	
		2 m	M18SN6R	M18SP6R
		4-pin Euro QD	M18SN6RQ	M18SP6RQ

### Retro & Polar Retro M18

Infrared LED

Visible Red LED

Sensing Mode	Range	Connection	Models NPN	Models PNP
 RETRO	2 m <sup>†</sup>	2 m	M18SN6L	M18SP6L
		4-pin Euro QD	M18SN6LQ	M18SP6LQ
 POLAR RETRO	2 m <sup>†</sup>	2 m	M18SN6LP	M18SP6LP
		4-pin Euro QD	M18SN6LPQ	M18SP6LPQ

For more specifications see page 135.

Connection options: A model with a QD requires a mating cordset (see page 132).

For 9 m cable, add suffix W/30 to the 2 m model number (example, M18SP6D W/30).

<sup>†</sup> Retroreflective range is specified using one model BRT-3 retroreflector, unless otherwise noted.

Actual sensing range may differ, depending on the efficiency and reflective area of the retroreflector used.

See Accessories section for more information.

Diffuse M18

 Infrared LED

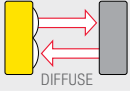
Sensing Mode	Range	Connection	Models NPN	Models PNP
	100 mm	2 m	M18SN6D-2M	M18SP6D-2M
		4-pin Euro QD	M18SN6DQ-Q8	M18SP6DQ-Q8
	300 mm	2 m	M18SN6DL-2M	M18SP6DL-2M
		4-pin Euro QD	M18SN6DLQ-Q8	M18SP6DLQ

Fixed-Field M18

 Infrared LED

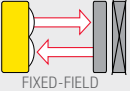
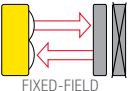
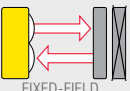
Sensing Mode	Range	Connection	Models NPN	Models PNP
	0 - 25 mm Cutoff	2 m	M18SN6FF25	M18SP6FF25
		4-pin Euro QD	M18SN6FF25Q	M18SP6FF25Q
	0 - 50 mm Cutoff	2 m	M18SN6FF50	M18SP6FF50
		4-pin Euro QD	M18SN6FF50Q	M18SP6FF50Q
	0 - 100 mm Cutoff	2 m	M18SN6FF100	M18SP6FF100
		4-pin Euro QD	M18SN6FF100Q	M18SP6FF100Q

For more specifications see page 135.

 Connection options: A model with a QD requires a mating cordset (see page 132).  
 For 9 m cable, add suffix W/30 to the 2 m model number (example, M18SP6D W/30).

# M18-3 Series

## Heavy-Duty Metal Barrel-Mount Sensors



- Economical photoelectric sensors for cost sensitive and high volume installations
- Powerful and bright visible red emitter beam for easy alignment and set-up
- Advanced ASIC technology is resistant to optical and electrical noise source
- Robust 250° adjustment potentiometer on select models
- Cordsets and brackets see page 132

### Opposed M18-3

➔ Visible Red LED

Sensing Mode	Range	Connection	Models NPN	Models PNP	
	25 m	Emitter	2 m	M186-3NAEL-2M	
			4-pin Euro QD	M186-3NAEL-Q8	
			2 m	M186-3NAEJ-2M (with Beam inhibit)	
			4-pin Euro QD	M186-3NAEJ-Q8 (with Beam inhibit)	
			2 m	M186-3NAES-2M (with Adjustment)	
	25 m	Receiver	4-pin Euro QD	M186-3NAES-Q8 (with Adjustment)	
			2 m	M18-3VNRL-2M	M18-3VPRL-2M
			4-pin Euro QD	M18-3VNRL-Q8	M18-3VPRL-Q8
			2 m	M18-3VNRS-2M (with Adjustment)	M18-3VPRS-2M (with Adjustment)
			4-pin Euro QD	M18-3VNRS-Q8 (with Adjustment)	M18-3VPRS-Q8 (with Adjustment)

### Retro & Polar Retro M18-3

⇔ Infrared LED

➔ Visible Red LED

Sensing Mode	Range †	Connection	Models NPN	Models PNP
	7.5 m	2 m	M18-3VNLV-2M (with Adjustment)	M18-3VPLV-2M (with Adjustment)
		4-pin Euro QD	M18-3VNLV-Q8 (with Adjustment)	M18-3VPLV-Q8 (with Adjustment)
	2 m	2 m	M18-3VNLP-2M	M18-3VPLP-2M
		4-pin Euro QD	M18-3VNLP-Q8	M18-3VPLP-Q8
		2 m	M18-3VNLPC-2M (with Adjustment)	M18-3VPLPC-2M (with Adjustment)
		4-pin Euro QD	M18-3VNLPC-Q8 (with Adjustment)	M18-3VPLPC-Q8 (with Adjustment)

For more specifications see page 135.

➔ Connection options: A model with a QD requires a mating cordset (see page 132).

For 150 mm cable with a 4-pin M12/Euro-style quick disconnect model, add the suffix "Q5". For example, M18-3VNRLQ5.

† Retroreflective range is specified using one model BRT-84.

Actual sensing range may differ, depending on the efficiency and reflective area of the retroreflector used. See Accessories section for more information.



## Diffuse M18-3

 Visible Red LED

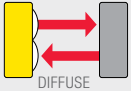
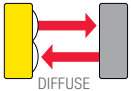
Sensing Mode	Range	Connection	Models NPN	Models PNP
 DIFFUSE	750 mm	2 m	M18-3VNDL-2M (Adjustment)	M18-3VPDL-2M (Adjustment)
		4-pin Euro QD	M18-3VNDL-Q8 (Adjustment)	M18-3VPDL-Q8 (Adjustment)
 DIFFUSE	300 mm	2 m	M18-3VNDS-2M (Adjustment)	M18-3VPDS-2M (Adjustment)
		4-pin Euro QD	M18-3VNDS-Q8 (Adjustment)	M18-3VPDS-Q8 (Adjustment)

## Fixed-Field M18-3

 Visible Red LED

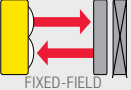
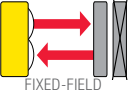
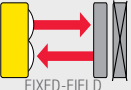
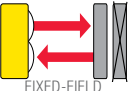
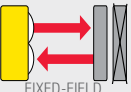
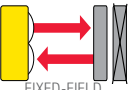
Sensing Mode	Range	Connection	Models NPN	Models PNP
 FIXED-FIELD	30 mm	2 m	M18-3VNFF30-2M	M18-3VPFF30-2M
		4-pin Euro QD	M18-3VNFF30-Q8	M18-3VPFF30-Q8
 FIXED-FIELD	50 mm	2 m	M18-3VNFF50-2M	M18-3VPFF50-2M
		4-pin Euro QD	M18-3VNFF50-Q8	M18-3VPFF50-Q8
 FIXED-FIELD	75 mm	2 m	M18-3VNFF75-2M	M18-3VPFF75-2M
		4-pin Euro QD	M18-3VNFF75-Q8	M18-3VPFF75-Q8
 FIXED-FIELD	100 mm	2 m	M18-3VNFF100-2M	M18-3VPFF100-2M
		4-pin Euro QD	M18-3VNFF100-Q8	M18-3VPFF100-Q8
 FIXED-FIELD	150 mm	2 m	M18-3VNFF150-2M	M18-3VPFF150-2M
		4-pin Euro QD	M18-3VNFF150-Q8	M18-3VPFF150-Q8
 FIXED-FIELD	200 mm	2 m	M18-3VNFF200-2M	M18-3VPFF200-2M
		4-pin Euro QD	M18-3VNFF200-Q8	M18-3VPFF200-Q8

For more specifications see page 135.

 Connection options: A model with a QD requires a mating cordset (see page 132).

For 150 mm cable with a 4-pin M12/Euro-style quick disconnect model, add the suffix "Q5". For example, M18-3VNDL-Q5.

# M18-4 Series

## Metal Barrel-Mount Sensors



- Chemically robust stainless steel sensors for wash-down applications
- Powerful and bright visible red emitter beam for easy alignment and set-up
- Advanced ASIC technology is resistant to optical and electrical noise source
- Robust 250° adjustment potentiometer on select models
- Cordsets and brackets see page 132

### Opposed M18-4

Visible Red LED

Sensing Mode	Range	Connection	Models NPN	Models PNP
 OPPOSED	25 m	2 m	M18-4NAEL-2M Emitter	
		4-pin Euro QD	M18-4NAEL-Q8 Emitter	
		2 m	M18-4NAEJ-2M Emitter (Beam inhibit)	
		4-pin Euro QD	M18-4NAEJ-Q8 Emitter (Beam inhibit)	
 OPPOSED	25 m	2 m	M18-4NAES-2M Emitter (Adjustment)	
		4-pin Euro QD	M18-4NAES-Q8 Emitter (Adjustment)	
		2 m	M18-4VNRL-2M	M18-4VPRL-2M
		4-pin Euro QD	M18-4VNRL-Q8	M18-4VPRL-Q8
		2 m	M18-4VNRS-2M (Adjustment)	M18-4VPRS-2M (Adjustment)
		4-pin Euro QD	M18-4VNRS-Q8 (Adjustment)	M18-4VPRS-Q8 (Adjustment)

### Retro & Polar Retro M18-4

Infrared LED Visible Red LED

Sensing Mode	Range †	Connection	Models NPN	Models PNP
 RETRO	7.5 m	2 m	M18-4VNLV-2M (Adjustment)	M18-4VPLV-2M (Adjustment)
		4-pin Euro QD	M18-4VNLV-Q8 (Adjustment)	M18-4VPLV-Q8 (Adjustment)
 POLAR RETRO	2 m	2 m	M18-4VNLP-2M	M18-4VPLP-2M
		4-pin Euro QD	M18-4VNLP-Q8	M18-4VPLP-Q8
		2 m	M18-4VNLPC-2M (Adjustment)	M18-4VPLPC-2M (Adjustment)
		4-pin Euro QD	M18-4VNLPC-Q8 (Adjustment)	M18-4VPLPC-Q8 (Adjustment)

For more specifications see page 135.

Connection options: A model with a QD requires a mating cordset (see page 132).

For 150 mm cable with a 4-pin M12/Euro-style quick disconnect model, add the suffix "Q5". For example, M18-4VNRL-Q5.

† Retroreflective range is specified using one model BRT-84.

Actual sensing range may differ, depending on the efficiency and reflective area of the retroreflector used. See Accessories section for more information.

Diffuse M18-4

 Visible Red LED

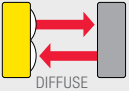
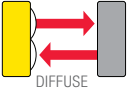
Sensing Mode	Range	Connection	Models NPN	Models PNP
 DIFFUSE	750 mm	2 m	M18-4VNDL-2M (Adjustment)	M18-4VPDL-2M (Adjustment)
		4-pin Euro QD	M18-4VNDL-Q8 (Adjustment)	M18-4VPDL-Q8 (Adjustment)
 DIFFUSE	300 mm	2 m	M18-4VNDS-2M (Adjustment)	M18-4VPDS-2M (Adjustment)
		4-pin Euro QD	M18-4VNDS-Q8 (Adjustment)	M18-4VPDS-Q8 (Adjustment)

Fixed-Field M18-4

 Visible Red LED

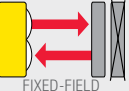
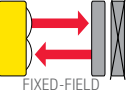
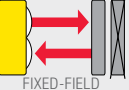
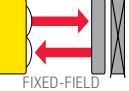
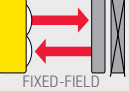
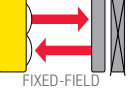
Sensing Mode	Range	Connection	Models NPN	Models PNP
 FIXED-FIELD	30 mm	2 m	M18-4VNFF30-2M	M18-4VPFF30-2M
		4-pin Euro QD	M18-4VNFF30-Q8	M18-4VPFF30-Q8
 FIXED-FIELD	50 mm	2 m	M18-4VNFF50-2M	M18-4VPFF50-2M
		4-pin Euro QD	M18-4VNFF50-Q8	M18-4VPFF50-Q8
 FIXED-FIELD	75 mm	2 m	M18-4VNFF75-2M	M18-4VPFF75-2M
		4-pin Euro QD	M18-4VNFF75-Q8	M18-4VPFF75-Q8
 FIXED-FIELD	100 mm	2 m	M18-4VNFF100-2M	M18-4VPFF100-2M
		4-pin Euro QD	M18-4VNFF100-Q8	M18-4VPFF100-Q8
 FIXED-FIELD	150 mm	2 m	M18-4VNFF150-2M	M18-4VPFF150-2M
		4-pin Euro QD	M18-4VNFF150-Q8	M18-4VPFF150-Q8
 FIXED-FIELD	200 mm	2 m	M18-4VNFF200-2M	M18-4VPFF200-2M
		4-pin Euro QD	M18-4VNFF200-Q8	M18-4VPFF200-Q8

For more specifications see page 135.

 Connection options: A model with a QD requires a mating cordset (see page 132).  
 For 150 mm cable with a 4-pin M12/Euro-style quick disconnect model, add the suffix "Q5". For example, M18-3VNDL-Q5.



4-Pin  
**MQDC-406**  
 2 m (6.5')  
**MQDC-415**  
 5 m (15')  
**MQDC-430**  
 9 m (30')

**Euro-Style**  
 Straight connector models listed;  
 for right-angle, add **RA** to the end  
 of the model number (example,  
**MQDC-406RA**)

Additional cordset information is available  
 See page 758



4-Pin  
**MQAC-406**  
 2 m (6.5')  
**MQAC-415**  
 5 m (15')  
**MQAC-430**  
 9 m (30')

4-Pin  
**MQAC-406**  
 2 m (6.5')  
**MQAC-415**  
 5 m (15')  
**MQAC-430**  
 9 m (30')

Reflectors



Additional information is available  
 See page 790

Apertures



Additional information is available  
 See page 816



SMB18A



SMBAMS18P

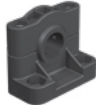

SMB3018SC



SMB18FAM12

Additional bracket information is available  
 See page 723



S18-2 dc Polarized Retroreflective  
 and Fixed-Field Models  
 Suffix LP and FF



S18 dc Opposed, Non-polarized  
 Retroreflective and Diffuse Models  
 Suffix E, R, L and D



S18 ac Opposed, Retroreflective,  
 Polarized Retroreflective, Diffuse and  
 Fixed-Field Models  
 Suffix E, R, L, LP, D and FF



M18 Opposed, Non-polarized  
 Retroreflective and Diffuse Models  
 Suffix E, R, L, D and DL





M18-3 Opposed, Retroreflective,  
 Polarized Retroreflective, Fixed-Field and Diffuse Models  
 Suffix E, R, L, D and DL





M18-4 Opposed, Retroreflective,  
 Polarized Retroreflective, Fixed-Field and Diffuse Models  
 Suffix E, R, L, D and DL

## S18-2 and S18 DC Specifications

<b>Supply Voltage and Current</b>	<p><b>S18:</b> 10 to 30 V dc (10% max. ripple); Supply current (exclusive of load current):  <b>S18-2:</b> 10 to 30 V dc ≤ 55° C; 10 to 24 V dc &gt; 55° C (10% max. ripple); Supply current (exclusive of load current):</p> <p><b>S18-2:</b>   <b>Opposed Emitters:</b> 17 mA           <b>S18:</b> Opposed Emitters: 25 mA                <b>Opposed Receivers:</b> 8 mA       <b>Opposed Receivers:</b> 20 mA                <b>Polarized Retroreflective:</b> 16 mA   <b>Polarized Retroreflective:</b> 30 mA                <b>Diffuse:</b> 16 mA                   <b>Non-polarized Retroreflective:</b> 25 mA    <b>Fixed-Field:</b> 35 mA    <b>Diffuse:</b> 25 mA</p>
<b>Supply Protection Circuitry</b>	Protected against reverse polarity and transient voltages
<b>Output Configuration</b>	Solid-state complementary dc switch; NPN (current sinking) or PNP (current sourcing), depending on model <b>S18:</b> The Dark Operate (DO) output may be wired as a normally open marginal signal alarm output, depending upon hookup to the power supply
<b>Output Rating</b>	<p><b>S18:</b> 150 mA max. (each) in standard hookup. When wired for alarm output, the total load may not exceed 150 mA  <b>S18-2:</b> Less than or equal to 100 mA total current through both outputs at less than or at 55 °C  Less than or equal to 50 mA total current for ambient temperatures greater than 55 °C  <b>OFF-state leakage current: S18-2:</b> less than 50 µA at 30 V dc    <b>S18:</b> less than 1 µA at 30 V dc  <b>ON-state saturation voltage: S18-2:</b> less than 1.5 V at 10 mA dc; less than 2.75 V at 100 mA dc    <b>S18:</b> less than 1 V at 10 mA dc; less than 1.5 V at 150 mA dc</p>
<b>Output Protection Circuitry</b>	Protected against false pulse on power-up and continuous overload or short circuit of outputs
<b>Output Response Time</b>	<p><b>S18-2: Opposed:</b> 1.5 milliseconds ON, 1.0 milliseconds OFF                    <b>Retro, Polarized Retroreflective and Diffuse:</b> 1.5 milliseconds ON, 0.75 milliseconds OFF  <b>S18: Opposed:</b> 3 milliseconds ON, 1.5 milliseconds OFF                    <b>Polarized Retroreflective, Non-polarized Retroreflective, Fixed-Field and Diffuse:</b> 3 milliseconds ON/OFF</p>
<b>Delay at Power-up</b>	100 milliseconds; outputs are non-conducting during this time
<b>Repeatability</b>	<p><b>S18-2: Opposed:</b> 170 microseconds                    <b>Polarized Retroreflective and Diffuse:</b> 100 microseconds  <b>S18: Opposed:</b> 375 microseconds                    <b>Polarized Retroreflective, Non-polarized Retroreflective, Fixed-Field and Diffuse:</b> 750 microseconds. Repeatability and response are independent of signal strength.</p>
<b>Adjustments</b>	<p><b>Diffuse (DL), Emitter (ES), Receiver (RS), Polarized Retroreflective (LPC), Retroreflective (LV) models:</b> Single turn sensitivity (gain) adjustment potentiometer  <b>Emitter Beam Inhibit (EJ) models:</b> Tie black wire to 10 to 30 V dc for beam inhibit</p>
<b>Indicators</b>	<p><b>S18-2: Three LED's: Green:</b> Power is ON           <b>Green Flashing:</b> Marginal sensing signal           <b>Yellow:</b> Pin 4 (black wire) output conducting  <b>S18: Two LEDs: Green:</b> Power is ON           <b>Green Flashing:</b> Output overloaded           <b>Yellow:</b> Light Operate (LO) output is energized</p>
<b>Construction</b>	<p><b>S18-2 models:</b> ABS housing  <b>S18 models:</b> thermoplastic polyester housing  Lenses are polycarbonate or acrylic; S18 models come with two jam nuts</p>
<b>Environmental Rating</b>	<p><b>S18-2:</b> IEC 60529 IP67  <b>S18:</b> Leakproof design rated NEMA 6P, IP67. QD models rated IP69K per DIN 40050-9.</p>
<b>Connections</b>	2 m or 9 m attached cable, or 4-pin Euro-style quick-disconnect fitting. QD cordsets are ordered separately.
<b>Operating Conditions</b>	<b>Temperature:</b> -40° to +70° C <b>Relative humidity: S18:</b> 90% at 50° C (non-condensing) <b>S18-2:</b> 95% @ 50° C (non-condensing)
<b>Vibration and Mechanical Shock</b>	All models meet Mil. Std. 202F requirements. Method 201A (Vibration; frequency 10 to 60 Hz, max., double amplitude 0.06-inch acceleration 10G). Method 213B conditions H&I (Shock: 75G with unit operating; 100G for non-operation)
<b>Certifications</b>	<p>S18-2, S18 models:     S18 models:      ECOLAB® chemical compatibility pending on some models; contact Banner Engineering for details</p>

## S18 AC Specifications

Supply Voltage and Current	20 to 250 V ac (50/60 Hz). <b>Average current:</b> 20 mA. <b>Peak current:</b> 200 mA at 20 V ac, 500 mA at 120 V ac, 750 mA at 250 V ac
Supply Protection Circuitry	Protected against transient voltages
Output Configuration	Solid-state ac switch; three-wire hookup; Light Operate (LO) or Dark Operate (DO), depending on model <b>Light Operate:</b> Output conducts when the sensor sees its own (or the emitter's) modulated light <b>Dark Operate:</b> Output conducts when sensor sees dark
Output Rating	300 mA max. (continuous) <b>Fixed-Field:</b> derate 5 mA/° C above +50° C <b>Inrush capability:</b> 1 amp for 20 milliseconds, non-repetitive <b>OFF-state leakage current:</b> less than 100 µA <b>ON-state voltage drop:</b> 3 V at 300 mA ac; 2 V at 15 mA ac
Output Protection Circuitry	Protected against false pulse on power-up
Output Response Time	<b>Opposed:</b> 16 milliseconds ON, 8 milliseconds OFF <b>Polarized Retroreflective, Non-polarized Retroreflective, Fixed-Field and Diffuse:</b> 16 milliseconds ON/OFF
Delay at Power-up	100 milliseconds
Repeatability	<b>Opposed:</b> 2 milliseconds <b>Polarized Retroreflective, Non-polarized Retroreflective, Fixed-Field and Diffuse:</b> 4 milliseconds Repeatability and response are independent of signal strength.
Indicators	<b>Two LEDs:</b> <b>Green:</b> Power ON <b>Yellow:</b> Light sensed <b>Yellow Flashing:</b> Marginal excess gain
Construction	Housings are thermoplastic polyester. Lenses are polycarbonate or acrylic; two jam nuts included.
Environmental Rating	Leakproof design rated NEMA 6P, IP67. QD models rated IP69K per DIN 40050-9.
Connections	2 m or 9 m attached cable, or 4-pin Micro-style quick-disconnect fitting. QD cordsets are ordered separately.
Operating Conditions	<b>Temperature:</b> -40° to +70° C <b>Relative humidity:</b> 90% at 50° C (non-condensing)
Vibration and Mechanical Shock	All models meet Mil. Std. 202F requirements. Method 201A (Vibration; frequency 10 to 60 Hz, max, double amplitude 0.06-inch acceleration 10G). Method 213B conditions H&I (Shock: 75G with unit operating; 100G for non-operation)
Certifications	   ECOLAB® chemical compatibility pending on some models; contact Banner Engineering for details



## M18 DC Specifications

Supply Voltage and Current	10 to 30 V dc (10% max. ripple); Supply current (exclusive of load current): <b>Opposed Emitters:</b> 25 mA <b>Opposed Receivers:</b> 20 mA <b>Polarized Retroreflective:</b> 30 mA <b>Non-polarized Retroreflective:</b> 25 mA <b>Fixed-Field:</b> 35 mA <b>Diffuse:</b> 25 mA
Supply Protection Circuitry	Protected against reverse polarity and transient voltages
Output Configuration	Solid-state complementary dc switch; NPN (current sinking) or PNP (current sourcing), depending on model The Dark Operate (DO) output may be wired as a normally open marginal signal alarm output, depending upon hookup to the power supply
Output Rating	150 mA max. (each) in standard hookup. When wired for alarm output, the total load may not exceed 150 mA <b>OFF-state leakage current:</b> less than 1 $\mu$ A at 30 V dc <b>ON-state saturation voltage:</b> less than 1 V at 10 mA dc; less than 1.5 V at 150 mA dc
Output Protection Circuitry	Protected against false pulse on power-up and continuous overload or short circuit of outputs
Output Response Time	<b>Opposed:</b> 3 milliseconds ON, 1.5 milliseconds OFF <b>Polarized Retroreflective, Non-polarized Retroreflective, Fixed-Field and Diffuse:</b> 3 milliseconds ON/OFF
Delay at Power-up	100 milliseconds; outputs are non-conducting during this time
Repeatability	<b>Opposed:</b> 375 microseconds <b>Polarized Retroreflective, Non-polarized Retroreflective, Fixed-Field and Diffuse:</b> 750 microseconds. Repeatability and response are independent of signal strength.
Indicators	<b>Two LEDs: Green:</b> Power is ON <b>Yellow:</b> Light Operate (LO) output is energized <b>Green Flashing:</b> Output overloaded <b>Yellow Flashing:</b> Marginal excess gain
Construction	Stainless steel housing Lenses are polycarbonate or acrylic; come with two jam nuts
Environmental Rating	Leakproof design rated NEMA 6P, IP67. QD models rated IP69K per DIN 40050-9.
Connections	2 m or 9 m attached cable, or 4-pin Euro-style quick-disconnect fitting. QD cordsets are ordered separately.
Operating Conditions	<b>Temperature:</b> -40° to +70° C <b>Relative humidity:</b> 90% at 50° C (non-condensing)
Vibration and Mechanical Shock	All models meet Mil. Std. 202F requirements. Method 201A (Vibration; frequency 10 to 60 Hz, max., double amplitude 0.06-inch acceleration 10G). Method 213B conditions H&I (Shock: 75G with unit operating; 100G for non-operation)
Certifications	

# S30 Series

## Plastic Barrel-Mount Sensors



- Long-range opposed mode
- Features 30 mm plastic threaded barrel
- Available in 10-30 V dc or 20-250 V ac
- Ideal for use in harsh sensing environments
- Cordsets and brackets see page 138

### Opposed S30, 10-30 V DC

Infrared LED

Sensing Mode	Range	Connection	Models NPN	Models PNP
 OPPOSED	60 m	2 m	S306E Emitter	
		4-Pin Euro QD	S306EQ Emitter	
		2 m	S30SN6R	S30SP6R
		4-Pin Euro QD	S30SN6RQ	S30SP6RQ

### Polar Retro S30, 10-30 V DC

Visible Red LED

Sensing Mode	Range	Connection	Models NPN	Models PNP
 POLAR RETRO	6 m <sup>†</sup>	2 m	S30SN6LP	S30SP6LP
		4-Pin Euro QD	S30SN6LPQ	S30SP6LPQ

### Fixed-Field S30, 10-30 V DC

Infrared LED

Sensing Mode	Range	Connection	Models NPN	Models PNP
 FIXED-FIELD	0 - 200 mm Cutoff	2 m	S30SN6FF200	S30SP6FF200
		4-Pin Euro QD	S30SN6FF200Q	S30SP6FF200Q
 FIXED-FIELD	0 - 400 mm Cutoff	2 m	S30SN6FF400	S30SP6FF400
		4-Pin Euro QD	S30SN6FF400Q	S30SP6FF400Q
 FIXED-FIELD	0 - 600 mm Cutoff	2 m	S30SN6FF600	S30SP6FF600
		4-Pin Euro QD	S30SN6FF600Q	S30SP6FF600Q

For more specifications see page 138.

Connection options: A model with a QD requires a mating cordset (see page 138).

For 9 m cable, add suffix W/30 to the 2 m model number (example, S30SP6LP W/30).

<sup>†</sup> Retroreflective range is specified using one model BRT-3 retroreflector.

Actual sensing range may differ, depending on the efficiency and reflective area of the retroreflector used. See Accessories for more information.

Opposed S30, 20-250 V AC

 Infrared LED

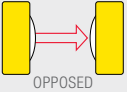
Sensing Mode	Range	Connection	Models Light Operate	Models Dark Operate
	60 m	2 m	S303E Emitter	
		4-Pin Micro QD	S303EQ1 Emitter	
		2 m	S30AW3R	S30RW3R
		4-Pin Micro QD	S30AW3RQ1	S30RW3RQ1

Polar Retro S30, 20-250 V AC

 Visible Red LED

Sensing Mode	Range	Connection	Models Light Operate	Models Dark Operate
	6 m <sup>†</sup>	2 m	S30AW3LP	S30RW3LP
		4-Pin Micro QD	S30AW3LPQ1	S30RW3LPQ1

Fixed-Field S30, 20-250 V AC

 Infrared LED

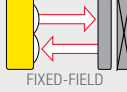
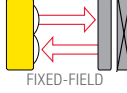
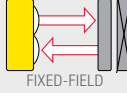
Sensing Mode	Range	Connection	Models Light Operate	Models Dark Operate
	0 - 200 mm Cutoff	2 m	S30AW3FF200	S30RW3FF200
		4-Pin Micro QD	S30AW3FF200Q1	S30RW3FF200Q1
	0 - 400 mm Cutoff	2 m	S30AW3FF400	S30RW3FF400
		4-Pin Micro QD	S30AW3FF400Q1	S30RW3FF400Q1
	0 - 600 mm Cutoff	2 m	S30AW3FF600	S30RW3FF600
		4-Pin Micro QD	S30AW3FF600Q1	S30RW3FF600Q1

For more specifications see page 139.

 Connection options: A model with a QD requires a mating cordset (see page 138).

For 9 m cable, add suffix W/30 to the 2 m model number (example, S30SP6LP W/30).

<sup>†</sup> Retroreflective range is specified using one model BRT-3 retroreflector.  
Actual sensing range may differ, depending on the efficiency and reflective area of the retroreflector used. See Accessories for more information.



**Euro-Style**  
Straight connector models listed; for right-angle, add **RA** to the end of the model number (example, **MQDC-406RA**)

**4-Pin**  
**MQDC-406**  
2 m (6.5')  
**MQDC-415**  
5 m (15')  
**MQDC-430**  
9 m (30')



**Micro-Style**  
Straight connector models listed; for right-angle, add **RA** to the end of the model number (example, **MQDC-306RA**)

**4-Pin**  
**MQAC-406**  
2 m (6.5')  
**MQAC-415**  
5 m (15')  
**MQAC-430**  
9 m (30')

Additional cordset information is available  
See page 758



SMB18A



SMBAMS18P

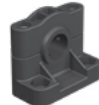

SMB3018SC



SMB18FA..

Additional bracket information is available  
See page 724



S30 DC Opposed, Polarized Retroreflective and Fixed-Field Models  
Suffix E, R, LP and FF



S30 AC Opposed, Polarized Retroreflective and Fixed-Field Models  
Suffix E, R, LP and FF

Reflectors



Apertures



Additional information is available  
See page 790

Additional information is available  
See page 816

S30 DC Specifications



Supply Voltage and Current	10 to 30 V dc (10% max. ripple); Supply current (exclusive of load current): <b>Opposed Emitters:</b> 25 mA <b>Opposed Receivers:</b> 20 mA <b>Polarized Retroreflective:</b> 30 mA <b>Fixed-Field:</b> 35 mA
Supply Protection Circuitry	Protected against reverse polarity and transient voltages
Output Configuration	Solid-state complementary; choose NPN (current sinking) or PNP (current sourcing) models. The Dark Operate (DO) output may be wired as a normally open marginal signal alarm output, depending upon hookup to the power supply.
Output Rating	150 mA max. (each) in standard hookup; When wired for alarm output, the total load may not exceed 150 mA <b>OFF-state leakage current:</b> less than 1 µA at 30 V dc <b>ON-state saturation voltage:</b> less than 1 V at 10 mA dc; less than 1.5 V at 150 mA dc
Output Protection Circuitry	Protected against false pulse on power-up and continuous overload or short circuit of outputs
Output Response Time	<b>Opposed:</b> 3 milliseconds ON; 1.5 milliseconds OFF <b>Polarized Retroreflective and Fixed-Field:</b> 3 milliseconds ON/OFF
Delay at Power-up	100 milliseconds; outputs are non-conducting during this time
Repeatability	<b>Opposed:</b> 375 microseconds <b>Polarized Retroreflective and Fixed-Field:</b> 750 microseconds Repeatability and response are independent of signal strength
Indicators	<b>Two LEDs:</b> <b>Solid Green:</b> Power ON <b>Flashing Green:</b> output over loaded <b>Solid Yellow:</b> Light Operate (LO) energized <b>Flashing Yellow:</b> marginal excess gain See datasheet for detailed information
Construction	Housings are thermoplastic polyester. Lenses are polycarbonate or acrylic; two jam nuts included.
Environmental Rating	Leakproof design rated NEMA 6P, IP67. QD models rated IP69K per DIN 40050-9.
Connections	2 m or 9 m attached cable, or 4-pin Euro-style quick-disconnect fitting. QD cordsets are ordered separately.
Operating Conditions	<b>Temperature:</b> -40° to +70° C <b>Relative humidity:</b> 90% at 50° C (non-condensing)
Vibration and Mechanical Shock	All models meet Mil. Std. 202F requirements. Method 201A (Vibration; frequency 10 to 60 Hz, max., double amplitude 0.06-inch acceleration 10G). Method 213B conditions H&I (Shock: 75G with unit operating; 100G for non-operation)

Certifications



ECOLAB® chemical compatibility pending on some models; contact Banner Engineering for details

## S30 AC Specifications

Supply Voltage and Current	20 to 250 V ac (50/60 Hz). Average current: 20 mA <b>Peak current:</b> 200 mA at 20 V ac, 500 mA at 120 V ac, 750 mA at 250 V ac
Supply Protection Circuitry	Protected against transient voltages
Output Configuration	Solid-state ac switch; three-wire hookup; choose Light Operate (LO) or Dark Operate (DO) models; <b>Light Operate:</b> Output conducts when the sensor sees its own (or the emitter's) modulated light <b>Dark Operate:</b> Output conducts when sensor sees dark
Output Rating	300 mA max. (continuous) <b>Fixed-Field:</b> derate 5 mA/° C above +50° C <b>Inrush capability:</b> 1 amp for 20 milliseconds, non-repetitive <b>OFF-state leakage current:</b> less than 100 µA <b>ON-state voltage drop:</b> 3 V at 300 mA ac; 2 V at 15 mA ac
Output Protection Circuitry	Protected against false pulse on power-up
Output Response Time	<b>Opposed:</b> 16 milliseconds ON; 8 milliseconds OFF <b>Polarized Retroreflective and Fixed-Field:</b> 16 milliseconds ON/OFF
Delay at Power-up	100 milliseconds
Repeatability	<b>Opposed:</b> 2 milliseconds <b>Polarized Retroreflective and Fixed-Field:</b> 4 milliseconds Repeatability and response are independent of signal strength
Indicators	<b>Two LEDs:</b> <b>Solid Green:</b> Power ON <b>Solid Yellow:</b> Light Operate (LO) energized <b>Flashing Yellow:</b> marginal excess gain See datasheet for detailed information
Construction	Housings are thermoplastic polyester. Lenses are polycarbonate or acrylic; two jam nuts included
Environmental Rating	Leakproof design rated NEMA 6P, IP67. QD models rated IP69K per DIN 40050-9
Connections	2 m or 9 m attached cable, or 4-pin Micro-style quick-disconnect fitting QD cordsets are ordered separately.
Operating Conditions	<b>Temperature:</b> -40° to +70° C <b>Relative humidity:</b> 90% at 50° C (non-condensing)
Vibration and Mechanical Shock	All models meet Mil. Std. 202F requirements. Method 201A (Vibration; frequency 10 to 60 Hz, max, double amplitude 0.06-inch acceleration 10G). Method 213B conditions H&I (Shock: 75G with unit operating; 100G for non-operation).
Certifications	   ECOLAB® chemical compatibility pending on some models; contact Banner Engineering for details

# SM30 Series

## Long-Range, Opposed-Mode Barrel Sensors



- Available with ac or dc supply voltages
- Ideal in equipment washdown environments
- Epoxy-encapsulated
- Sensing range up to 200 m

### Opposed SM30 Emitters, 10-30 V DC or 12-240 V AC, Frequency A<sup>†</sup>

Infrared LED

Sensing Mode	Housing	Range	Connection	Output Type	Models
 OPPOSED	Plastic	150 m	2 m 3-Pin Mini QD	N/A	SMA30PEL SMA30PELQD
	Stainless Steel	150 m	2 m 3-Pin Mini QD	N/A	SMA30SEL SMA30SELQD

### Opposed SM30 Receivers, 10-30 V DC Frequency A<sup>†</sup>

Infrared LED

Sensing Mode	Housing	Range	Connection	Output Type	Models
 OPPOSED	Plastic	150 m	2 m 4-Pin Mini QD	Bi-Modal™ NPN or PNP	SM30PRL SM30PRLQD
	Stainless Steel	150 m	2 m 4-Pin Mini QD	Bi-Modal™ NPN or PNP	SM30SRL SM30SRLQD

### Opposed SM30 Receivers, 24-240 V AC, Frequency A<sup>†</sup>

Infrared LED

Sensing Mode	Housing	Range	Connection	Output Type	Models
 OPPOSED	Plastic	150 m	2 m	LO	SM2A30PRL
			3-Pin Mini QD		SM2A30PRLQD
	Stainless Steel	150 m	2 m	LO	SM2A30SRL
			3-Pin Mini QD		SM2A30SRLQD
	Plastic	150 m	2 m	DO	SM2A30PRLNC
			3-Pin Mini QD		SM2A30PRLNCQD
Stainless Steel	150 m	2 m	DO	SM2A30SRLNC	
		3-Pin Mini QD		SM2A30SRLNCQD	

Connection options: A model with a QD requires a mating cordset.

For 9 m cable, add suffix W/30 to the 2 m model number (example, SMA30PEL W/30).

<sup>†</sup> Modulation frequency "A" is standard; frequencies "B" and "C" are also available to minimize optical crosstalk potential between adjacent pairs and are specified by adding "B" or "C" at the end of the standard model number (example, SMA30PELB or SMA30PELC).





Additional cordset information is available  
 See page 758



Additional bracket information is available  
 See page 724



Opposed Models—All Frequencies  
 Suffix E and R  
 (Metal Housing Shown)



### SM30 Specifications



Supply Voltage and Current	<b>Emitters:</b> 12 to 240 V ac (50/60 Hz) or 10 to 30 V dc (10% max. ripple) at 20 mA <b>DC Receivers:</b> 10 to 30 V dc (10% max. ripple) at 10 mA max, exclusive of load <b>AC Receivers:</b> 24 to 240 V ac (50/60 Hz)
Supply Protection Circuitry	Protected against reverse polarity and transient voltages
Output Configuration	<b>DC Receivers:</b> Bi-Modal™ output (PNP sourcing or NPN sinking). Selection of sourcing or sinking configuration depends upon receiver's power supply hookup polarity. Once wired, the unit performs as a solid-state switch. <b>AC Receivers:</b> Solid-state switch offer Light Operate (LO) or Dark Operate (DO) by model
Output Rating	<b>DC Receivers:</b> 250 mA continuous <b>Output saturation voltage:</b> (PNP & NPN configuration) less than 1 volt at 10 mA; less than 2 volts at 250 mA <b>OFF-state leakage current:</b> less than 10 µA <b>AC Receivers:</b> Max. steady-state load capability is 500 mA <b>Inrush capability:</b> 10 amps for 1 second (non-repeating) <b>OFF-state leakage:</b> current less than 1.7 mA rms <b>ON-state voltage drop:</b> less than 3.5 volts rms across a 500 mA load; less than 5 volts rms across a 15 mA load
Output Protection Circuitry	Outputs of dc receivers are short circuit protected
Output Response Time	10 milliseconds ON/OFF
Repeatability	<b>"A" frequency units:</b> 1 millisecond <b>"B" frequency units:</b> 1.5 milliseconds <b>"C" frequency units:</b> 2.3 milliseconds
Indicators	Internal Red LED, visible through the lens or from side of the sensor. <b>Emitters:</b> Red "Power ON" indicator LED <b>DC Receivers:</b> Lights whenever receiver sees its modulated light source <b>AC Receivers:</b> Lights whenever receiver's output is conducting
Construction	Fully epoxy-encapsulated tubular threaded housing, positive sealed at both ends, quad-ring sealed acrylic lens <b>Plastic models:</b> 30 mm diameter thermoplastic polyester housing and jam nuts <b>Stainless Steel models:</b> 30 mm diameter 303 stainless steel housing and jam nuts
Environmental Rating	Exceeds NEMA 6P; IEC IP67 standards
Connections	PVC-jacketed 2 m or 9 m cables or Mini-style quick-disconnect (QD) fitting are available. QD cordsets are ordered separately.
Operating Conditions	<b>Temperature:</b> -40° to +70° C <b>Relative humidity:</b> 90% at 50° C (non-condensing)





## Slot & Area

Slot sensors, also known as fork sensors, provide easy and reliable opposed-mode sensing of objects as small as 0.3 mm. Slot sensors are offered in a wide variety of sizes to meet your application needs.

Series	Description	Max Sensing Range	Dimensions H x W x D	Protection Rating	Housing Material	Power Supply
	<p><b>SLM</b> Easy to mount, focus-beamed sensors with powerful optics. Page 144</p>	<p><b>Opposed:</b> 220 mm</p>	<p>Varies by model</p>	<p>IP67; NEMA 6</p>	<p>Die-cast zinc</p>	<p>10 to 30 V dc</p>
	<p><b>SL30 &amp; SL10</b> A fixed-distance slot sensor with a slot that offers high speed sensing with expert push-button TEACH options. Page 146</p>	<p><b>Opposed:</b> 30 mm</p>	<p>72 x 52 x 18.8 mm</p>	<p>IP67; NEMA 6</p>	<p>ABS/polycarbonate</p>	<p>10 to 30 V dc</p>
	<p><b>LX</b> Part-Sensing Arrays provides wide area detection used for detecting small parts on conveyors, part ejection verification and leading edge detection. Page 148</p>	<p><b>Opposed:</b> 2 m</p>	<p>Varies by model</p>	<p>IP65</p>	<p>Aluminum housing, die-cast zinc with black e-coated painted endcaps</p>	<p>10 to 30 V dc</p>

# SLM Series

## Rugged, Nickel-Plated, Fixed-Distance Slot Sensors



- Easy to mount, focus-beamed sensors with powerful optics.
- Powerful optics for detecting between sheets of plastic
- Requires no alignment, with easy and economical mounting that uses molded in-beam guides to simplify beam placement
- Rugged metal housing rated to IP67

### SLM Nickel-Plated

➔ Visible Red LED

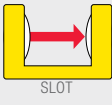
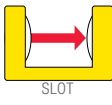
Sensing Mode	Slot Width/ Depth	Width (W)	Depth (D)	Connection	Response	Models NPN	Models PNP
	10 mm/ 60.8 mm	42 mm	80 mm	2 m 4-Pin Euro Pigtail QD 3-Pin Pico QD	500 μs	SLM10B6 (Bipolar NPN/PNP) SLM10B6QPMA (Bipolar NPN/PNP) SLM10N6Q	SLM10P6Q
	20 mm/ 60.8 mm	52 mm	80 mm	2 m 4-Pin Euro Pigtail QD 3-Pin Pico QD	500 μs	SLM20B6 (Bipolar NPN/PNP) SLM20B6QPMA (Bipolar NPN/PNP) SLM20N6Q	SLM20P6Q
	30 mm/ 60.8 mm	62 mm	80 mm	2 m 4-Pin Euro Pigtail QD 3-Pin Pico QD	500 μs	SLM30B6 (Bipolar NPN/PNP) SLM30B6QPMA (Bipolar NPN/PNP) SLM30N6Q	SLM30P6Q
	50 mm/ 60.8 mm	82 mm	80 mm	2 m 4-Pin Euro Pigtail QD 3-Pin Pico QD	500 μs	SLM50B6 (Bipolar NPN/PNP) SLM50B6QPMA (Bipolar NPN/PNP) SLM50N6Q	SLM50P6Q
	80 mm/ 60.8 mm	112 mm	80 mm	2 m 4-Pin Euro Pigtail QD 3-Pin Pico QD	500 μs	SLM80B6 (Bipolar NPN/PNP) SLM80B6QPMA (Bipolar NPN/PNP) SLM80N6Q	SLM80P6Q
	120 mm/ 120.7 mm	152 mm	140 mm	2 m 4-Pin Euro Pigtail QD 3-Pin Pico QD	500 μs	SLM120B6 (Bipolar NPN/PNP) SLM120B6QPMA (Bipolar NPN/PNP) SLM120N6Q	SLM120P6Q
	180 mm/ 120.7 mm	202 mm	140 mm	2 m 4-Pin Euro Pigtail QD 3-Pin Pico QD	500 μs	SLM180B6 (Bipolar NPN/PNP) SLM180B6QPMA (Bipolar NPN/PNP) SLM180N6Q	SLM180P6Q
	220 mm/ 120.7 mm	252 mm	140 mm	2 m 4-Pin Euro Pigtail QD 3-Pin Pico QD	500 μs	SLM220B6 (Bipolar NPN/PNP) SLM220B6QPMA (Bipolar NPN/PNP) SLM220N6Q	SLM220P6Q

 Connection options: A model with a QD requires a mating cordset

For 9 m cable, add suffix W/30 to the 2 m model number (example, SLM10B6 W/30).



**Euro QD**  
(for ..Q8 or ..Q5 models)  
Straight connector models listed; for right-angle, add **RA** to the end of the model number (example, **MQDC-406RA**)

**4-Pin**  
**MQDC-406**  
2 m (6')  
**MQDC-415**  
5 m (15')  
**MQDC-430**  
9 m (30')



**Pico QD (for Q models)**  
Straight connector models listed; for right-angle, **W** replaces **G** in the model number.  
(example, **PKW3M-5**)  
\*There are no PKW3M-7, or PKW3M-10 models available

**3-Pin**  
**PKG3M-2**  
2 m (6.5')  
**PKG3M-5**  
5 m (15')  
**PKG3M-7**  
7 m (23')  
**PKG3M-9**  
9 m (30')  
**PKG3M-10**  
10 m

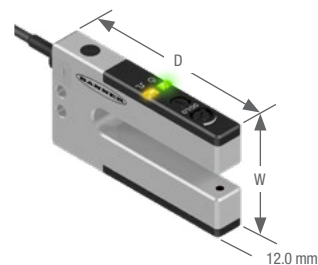

Additional cordset information is available  
See page 758

### SLM Specifications

<b>Slot Opening</b>	10, 20, 30, 50, 80, 120, 180 or 220 mm (depending on model); beam is 5 mm from outer edge							
<b>Supply Voltage and Current</b>	10 to 30 V dc (10% ripple) @ less than 25 mA, exclusive of load							
<b>Supply Protection Circuitry</b>	Protected against reverse polarity and transient voltages							
<b>Output Configuration</b>	<b>Cabled and Euro-style QD models: Bipolar:</b> One current sourcing ( <b>PNP</b> ) and one current sinking ( <b>NPN</b> ) <b>Pico-style QD models:</b> Current sourcing ( <b>PNP</b> ) or current sinking ( <b>NPN</b> ), depending on model							
<b>Output Rating</b>	100 mA with short circuit protection <b>OFF-state leakage current:</b> less than 10 µA sourcing; less than 200 µA sinking <b>ON-state saturation voltage:</b> <b>NPN:</b> 1.6 V @ 100 mA <b>PNP:</b> 2.0 V @ 100 mA							
<b>Output Protection Circuitry</b>	Protected against output short-circuit and false pulse on power up. 100 milliseconds max. delay at power up; outputs do not conduct during this time.							
<b>Minimum Object Detection* at Max. Gain</b>	<b>SLM10...</b>	<b>SLM20...</b>	<b>SLM30...</b>	<b>SLM50...</b>	<b>SLM80...</b>	<b>SLM120...</b>	<b>SLM180...</b>	<b>SLM220...</b>
	1.00 mm	1.25 mm	1.50 mm	1.65 mm	1.80 mm	1.80 mm	1.80 mm	2.40 mm
<b>Minimum Object Detection* at 2X Excess Gain</b>	0.30 mm	0.30 mm	0.40 mm	0.60 mm	0.75 mm	0.90 mm	0.90 mm	1.00 mm
<b>Hysteresis**</b>	0.10 mm	0.10 mm	0.10 mm	0.10 mm	0.20 mm	0.20 mm	0.20 mm	0.20 mm
<b>Repeatability†</b>	0.02 mm	0.02 mm	0.02 mm	0.04 mm	0.06 mm	0.08 mm	0.08 mm	0.08 mm
<b>Output Response Time</b>	500 microseconds							
<b>Repeatability</b>	95 microseconds							
<b>Adjustments</b>	1-turn potentiometer Sensitivity adjustment Light Operate / Dark Operate Selection switch							
<b>Indicators</b>	<b>Two LED Indicators:</b> <b>Solid Green:</b> Power ON <b>Flashing Green:</b> output short circuit <b>Solid Yellow:</b> Output activated See datasheet for detailed information							
<b>Construction</b>	<b>Housing:</b> Die-cast zinc <b>Endcaps:</b> ABS <b>Optic windows:</b> Acrylic							
<b>Environmental Rating</b>	IEC IP67; NEMA 6							
<b>Connections</b>	<b>Cabled models:</b> 2 m or 9 m 4-conductor, PVC-jacketed cable <b>Pico-style QD models:</b> 3-pin, threaded <b>Euro-style QD models:</b> 4-pin, threaded 150 mm pigtail with polyurethane (PUR) cable							
<b>Operating Conditions</b>	<b>Temperature:</b> -20° to +60° C <b>Relative humidity:</b> 95% @ 55° C (non-condensing)							
<b>Certifications</b>								

\* **Minimum Object Detection:** Smallest diameter rod that can be detected when passed slowly through sensing beam.

**NOTE:** Minimum object detection is measured midway between the emitter and receiver. For best results, objects to be detected should be placed in the midway position when possible.  
The minimum object detection size may increase if the object is very close to the receiver side.

\*\* **Hysteresis:** Distance an object must move to toggle between output OFF and output ON conditions.

† **Repeatability:** Variation in switching distance for a standard target at controlled sensing conditions.

# SL30 Series

## Fixed-Distance Slot Sensors



- Uses molded in-beam guides to simplify beam placement
- Provides easy-to-use self-contained opposed-mode sensor pair in rugged U-shaped housing
- Features manual sensitivity adjustment or easy push-button TEACH-mode setup, depending on model
- Cordsets and brackets see page 148

### SL30

Visible Red LED

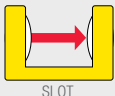
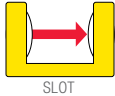
Sensing Mode	Slot Width	Connection	Output Type	Response	Repeatability	Models
	30 mm	2 m 5-Pin Euro QD	Bipolar NPN/PNP	1 ms	250 $\mu$ s	SL30VB6V SL30VB6VQ
	30 mm	2 m 5-Pin Euro QD	Bipolar NPN/PNP	300 $\mu$ s	75 $\mu$ s	SL30VB6VY SL30VB6VYQ

### SLO30

Infrared LED

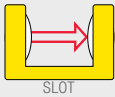
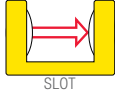
Sensing Mode	Slot Width	Connection	Output Type	Response	Repeatability	Models
	30 mm	2 m 5-Pin Euro QD	Bipolar NPN/PNP	1 ms	250 $\mu$ s	SLO30VB6 SLO30VB6Q
	30 mm	2 m 5-Pin Euro QD	Bipolar NPN/PNP	300 $\mu$ s	75 $\mu$ s	SLO30VB6Y SLO30VB6YQ

### SLE30 Expert™

Visible Red LED

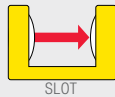
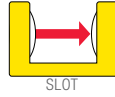
Sensing Mode	Slot Width	Connection	Output Type	Response	Repeatability	Models
	30 mm	2 m 5-Pin Euro QD	Bipolar NPN/PNP	500 $\mu$ s	100 $\mu$ s	SLE30B6V SLE30B6VQ
	30 mm	2 m 5-Pin Euro QD	Bipolar NPN/PNP	150 $\mu$ s	75 $\mu$ s	SLE30B6VY SLE30B6VYQ

For more specifications see page 148.

Connection options: A model with a QD requires a mating cordset (see page 148).

For 9 m cable, add suffix W/30 to the 2 m model number (example, SL30VB6V W/30).

# SL10 Series

## Fixed-Distance Slot Sensors



- Uses molded in-beam guides to simplify beam placement
- Provides easy-to-use self-contained opposed-mode sensor pair
- Features manual sensitivity adjustment or easy push-button TEACH-mode setup, depending on model
- Cordsets and brackets see page 148

### SL10

➔ Visible Red LED

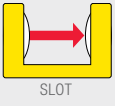
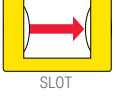
Sensing Mode	Slot Width	Connection	Output Type	Response	Repeatability	Models
	10 mm	2 m 5-Pin Euro QD	Bipolar NPN/PNP	1 ms	250 $\mu$ s	SL10VB6V SL10VB6VQ
	10 mm	2 m 5-Pin Euro QD	Bipolar NPN/PNP	300 $\mu$ s	75 $\mu$ s	SL10VB6VY SL10VB6VYQ

### SLE10 Expert™

➔ Visible Red LED

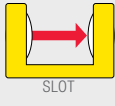
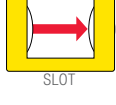
Sensing Mode	Slot Width	Connection	Output Type	Response	Repeatability	Models
	10 mm	2 m 5-Pin Euro QD	Bipolar NPN/PNP	500 $\mu$ s	100 $\mu$ s	SLE10B6V SLE10B6VQ
	10 mm	2 m 5-Pin Euro QD	Bipolar NPN/PNP	150 $\mu$ s	75 $\mu$ s	SLE10B6VY SLE10B6VYQ

For more specifications see page 148.

➔ Connection options: A model with a QD requires a mating cordset (see page 148).

For 9 m cable, add suffix W/30 to the 2 m model number (example, SL10VB6V W/30).





**Euro-Style**  
Straight connector models listed; for right-angle, add **RA** to the end of the model number (example, **MQDC1-506RA**)

**5-Pin**  
**MQDC1-501.5**  
0.5 m (1.6')  
**MQDC1-506**  
2 m (6.5')  
**MQDC1-515**  
5 m (15')  
**MQDC1-530**  
9 m (30')



**SMBSL**  
12-ga. stainless steel

Additional cordset information is available  
See page 758

Additional bracket information is available  
See page 724

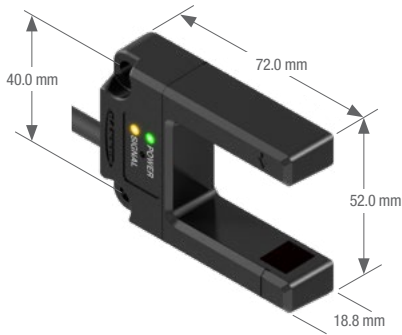

SL30, SLO30 and SLE30 Models

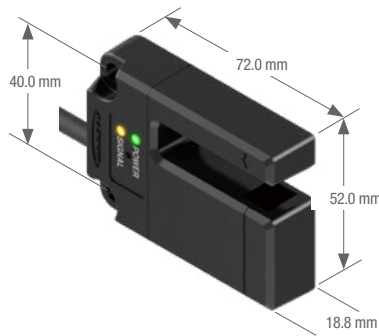

SL10 and SLE10 Models

### SL30, SL10 and SLO30 Specifications

Supply Voltage and Current	10 to 30 V dc, 30 mA
Supply Protection Circuitry	Protected against reverse polarity and transient voltages
Output Configuration	<b>Bipolar:</b> One current sinking (NPN) and one current sourcing (PNP) open-collector transistor
Output Rating	150 mA, each output
Output Protection Circuitry	Protected against false pulse on power-up and short-circuit of outputs
Output Response Time	1 millisecond or 300 microseconds, depending on model
Repeatability	250 microseconds or 75 microseconds, depending on model
Adjustments	<b>SL30 and SL10:</b> 4-turn clutched potentiometer sensitivity adjustment <b>SLO30:</b> None
Indicators	<b>Green:</b> Power ON/OFF indicator <b>Yellow:</b> Signal condition indicator
Construction	<b>Housing:</b> ABS/polycarbonate <b>Lenses:</b> Acrylic
Environmental Rating	IP67; NEMA 6
Connections	2 m or 9 m 5-conductor PVC-jacketed attached cable, or 5-pin Euro-style quick-disconnect (QD) fitting. QD cordsets are ordered separately.
Operating Conditions	<b>Temperature:</b> -40° to +70° C <b>Relative humidity:</b> 90% @ 50° C (non-condensing)



SLE30 and SLE10 *Expert*<sup>TM</sup> Specifications

Supply Voltage and Current	10 to 30 V dc (10% max. ripple) at less than 45 mA, exclusive of load
Supply Protection Circuitry	Protected against reverse polarity and transient voltages
Output Configuration	<b>Bipolar:</b> One current sourcing (PNP) and one current sinking (NPN) open-collector transistor
Output Rating	150 mA max. each output at 25° C, derated to 100 mA at 70° C (derate ≈1 mA per ° C) <b>OFF-state leakage current:</b> less than 5 µA @ 30 V dc <b>ON-state saturation current:</b> less than 1 V @ 10 mA; less than 1.5 V @ 150 mA
Output Protection Circuitry	Protected against false pulse on power-up and continuous overload or short-circuit of outputs
Output Response Time	Sensors will respond to either a "light" or a "dark" signal of 500 microseconds (or 150 microseconds, depending on model) or longer duration, 1 kHz max
Delay at Power-up	1 second; outputs are non-conducting during this time
Repeatability	100 microseconds or 75 microseconds, depending on model
Adjustments	Pushbutton TEACH-mode sensitivity setting; remote TEACH-mode input
Indicators	<b>Two LEDs:</b> Yellow and Bicolor Green/Red <b>Green (RUN Mode):</b> ON when power is applied Flashes when received light level approaches the switching threshold <b>Red (TEACH Mode):</b> OFF when no signal is received. Pulses to indicate signal strength (received light level). Rate is proportional to signal strength (the stronger the signal, the faster the pulse rate). This is a function of Banner's Alignment Indicating Device (AID <sup>TM</sup> ). <b>Alternating Red/Green:</b> Microprocessor memory error <b>Flashing</b> <b>Yellow (Static TEACH):</b> ON to indicate sensor is ready to learn output ON condition OFF to indicate sensor is ready to learn output OFF condition <b>Yellow (Dynamic TEACH):</b> Pulses at 0.5 Hz when ready to sample ON to indicate Dynamic TEACH sampling OFF to indicate sampling was accepted <b>Yellow (RUN Mode):</b> ON when outputs are conducting
Construction	<b>Housing:</b> ABS/polycarbonate <b>Lenses:</b> Acrylic
Environmental Rating	IEC IP67; NEMA 6
Connections	PVC-jacketed 5-conductor 2 m or 9 m unterminated cable, or 5-pin Euro-style quick-disconnect (QD) fitting. QD cordsets are ordered separately.
Operating Conditions	<b>Temperature:</b> -20° to +70° C <b>Relative humidity:</b> 90% at 50° C (non-condensing)
Application Notes	The first condition presented during TEACH mode becomes the output ON condition
Certifications	

# LX

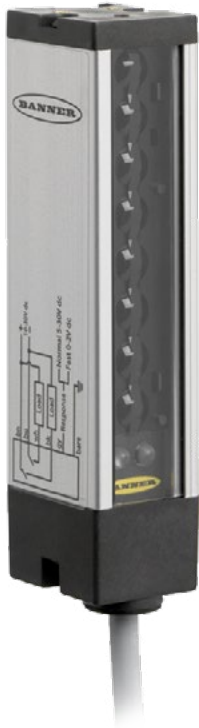

## High-Speed Part-Sensing Array

- Detects objects as small as 5.6 mm and extremely flat objects passing anywhere through the screen
- Responds in 0.8 to 6.5 milliseconds, faster than comparable products even at the slowest speed
- Features rugged silver anodized housing rated to IP65
- Uses integrated T-slot mounting channel for unique mounting flexibility

### LX Light Screens Short-Range (75-200 mm)

Sensing Array Length	Connection	Output Type	Min object detection size: 5.6 mm dia.	
			Emitters	Receivers
67 mm	2 m	Bipolar NPN/PNP	LX3ESR	LX3RSR
143 mm	2 m	Bipolar NPN/PNP	LX6ESR	LX6RSR
295 mm	2 m	Bipolar NPN/PNP	LX12ESR	LX12RSR

### LX Light Screens Standard Range (150 mm-2 m)

Sensing Array Length	Connection	Output Type	Min object detection size: 9.5 mm dia.	
			Emitters	Receivers
67 mm	2 m	Bipolar NPN/PNP	LX3E	LX3R
143 mm	2 m	Bipolar NPN/PNP	LX6E	LX6R
218 mm	2 m	Bipolar NPN/PNP	LX9E	LX9R
295 mm	2 m	Bipolar NPN/PNP	LX12E	LX12R
371 mm	2 m	Bipolar NPN/PNP	LX15E	LX15R
447 mm	2 m	Bipolar NPN/PNP	LX18E	LX18R
523 mm	2 m	Bipolar NPN/PNP	LX21E	LX21R
599 mm	2 m	Bipolar NPN/PNP	LX24E	LX24R

 Connection options: A model with a QD requires a mating cordset.  
 For 5-pin 150 mm Euro-style Pigtail QD, add suffix Q to the 2 m model number (example, LX3ESRQ).

**Euro-Style**  
 Straight connector models listed; for right-angle, add **RA** to the end of the model number (example, MQDC1-506RA)



**5-Pin**  
 MQDEC2-506  
 2 m (6.5')  
 MQDEC2-515  
 5 m (15')  
 MQDEC2-530  
 9 m (30')



SMBLX



SMBLXR

Additional cordset information is available  
 See page 758

Additional bracket information is available  
 See page 724



Models	Length (L)
LX3	113.4 mm
LX6	189.6 mm
LX9	265.8 mm
LX12	342.0 mm
LX15	418.2 mm
LX18	494.4 mm
LX21	570.6 mm
LX24	646.8 mm

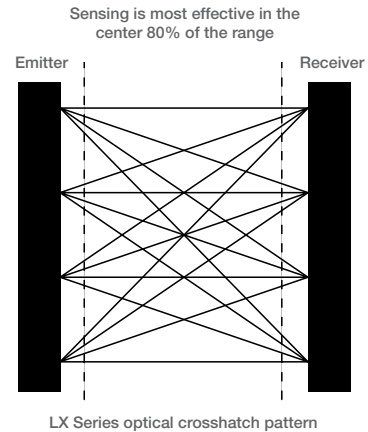

### LX Specifications

<b>Sensing Range</b>	<table border="0"> <tr> <td></td> <td><b>Normal (see hookups)</b></td> <td><b>Reduced</b></td> </tr> <tr> <td><b>Short-range models:</b></td> <td>100 to 200 mm</td> <td>75 to 150 mm</td> </tr> <tr> <td><b>Standard-range models:</b></td> <td>300 mm to 2 m</td> <td>150 to 600 mm</td> </tr> </table>		<b>Normal (see hookups)</b>	<b>Reduced</b>	<b>Short-range models:</b>	100 to 200 mm	75 to 150 mm	<b>Standard-range models:</b>	300 mm to 2 m	150 to 600 mm
	<b>Normal (see hookups)</b>	<b>Reduced</b>								
<b>Short-range models:</b>	100 to 200 mm	75 to 150 mm								
<b>Standard-range models:</b>	300 mm to 2 m	150 to 600 mm								
<b>Supply Voltage and Current</b>	10 to 30 V dc (10% max. ripple) at less than 1 watt each for emitter and receiver (exclusive of load)									
<b>Supply Protection Circuitry</b>	Protected against reverse polarity and transient voltages									
<b>Output Configuration</b>	<b>Bipolar:</b> One current sourcing (PNP) and one current sinking (NPN) open-collector transistor									
<b>Output Rating</b>	125 mA max. each output <b>OFF-state leakage current:</b> less than 5 $\mu$ A <b>Output saturation voltage (PNP output):</b> less than 1 volt at 10 mA and less than 1.5 volts at 100 mA <b>Output saturation voltage (NPN output):</b> less than 0.5 volts at 10 mA and less than 0.6 volts at 100 mA									
<b>Output Protection Circuitry</b>	Protected against false pulse on power-up and continuous overload or short circuit of outputs									
<b>Output Response Time</b>	<b>LX3:</b> 0.8 milliseconds ON-time; 6 milliseconds OFF-time (5 milliseconds OFF-delay) <b>LX6:</b> 1.6 milliseconds ON-time; 7 milliseconds OFF-time (5 milliseconds OFF-delay) <b>LX9:</b> 2.4 milliseconds ON-time; 7.5 milliseconds OFF-time (5 milliseconds OFF-delay) <b>LX12:</b> 3.2 milliseconds ON-time; 8.5 milliseconds OFF-time (5 milliseconds OFF-delay) <b>LX15:</b> 4.0 milliseconds ON-time; 9 milliseconds OFF-time (5 milliseconds OFF-delay) <b>LX18:</b> 4.8 milliseconds ON-time; 10 milliseconds OFF-time (5 milliseconds OFF-delay) <b>LX21:</b> 5.6 milliseconds ON-time; 11 milliseconds OFF-time (5 milliseconds OFF-delay) <b>LX24:</b> 6.4 milliseconds ON-time; 11.5 milliseconds OFF-time (5 milliseconds OFF-delay)									
<b>Minimum Object Detection Size</b>	<b>Smallest diameter rod that can be detected in sensing range:</b> 5.6 mm (short-range) or 9.5 mm (standard-range), depending on model									
<b>Indicators</b>	<table border="0"> <tr> <td><b>Emitter:</b></td> <td><b>LED1 (Green)</b> ON: Power ON, good sensor OFF: Reduced Range</td> <td><b>LED2 (Red)</b> ON: Reduced range OFF: Normal range Flashing: Emitter hardware failure</td> </tr> <tr> <td><b>Receiver:</b></td> <td><b>LED1 (Yellow)</b> ON: Output conducting OFF: Output not conducting</td> <td><b>LED2 (Bicolor Green/Red)</b> Green: Normal range Red: Reduced range Flashing Red: Receiver hardware failure</td> </tr> </table>	<b>Emitter:</b>	<b>LED1 (Green)</b> ON: Power ON, good sensor OFF: Reduced Range	<b>LED2 (Red)</b> ON: Reduced range OFF: Normal range Flashing: Emitter hardware failure	<b>Receiver:</b>	<b>LED1 (Yellow)</b> ON: Output conducting OFF: Output not conducting	<b>LED2 (Bicolor Green/Red)</b> Green: Normal range Red: Reduced range Flashing Red: Receiver hardware failure			
<b>Emitter:</b>	<b>LED1 (Green)</b> ON: Power ON, good sensor OFF: Reduced Range	<b>LED2 (Red)</b> ON: Reduced range OFF: Normal range Flashing: Emitter hardware failure								
<b>Receiver:</b>	<b>LED1 (Yellow)</b> ON: Output conducting OFF: Output not conducting	<b>LED2 (Bicolor Green/Red)</b> Green: Normal range Red: Reduced range Flashing Red: Receiver hardware failure								
<b>Construction</b>	Aluminum housing, die-cast zinc with black e-coated painted encaps, acrylic lens window									
<b>Environmental Rating</b>	IEC IP65									
<b>Connections</b>	2 m 5-conductor (with drain) PVC-jacketed cable or 150 mm pigtail with 5-pin Euro-style quick-disconnect fitting, depending on model. Cordsets are ordered separately.									
<b>Operating Conditions</b>	<b>Temperature:</b> -20° to +70° C <b>Relative humidity:</b> 90% at 50° C (non-condensing)									
<b>Application Notes</b>	<ol style="list-style-type: none"> <li>The best sensing resolution occurs within the center 80% of the sensing range</li> <li>Low-profile packages can be reliably detected</li> <li>Outputs are active while the light screen is interrupted</li> <li>For reliable detection, successive parts must be spaced up to the total of ON-time plus OFF-time apart. (i.e., 12 milliseconds for the LX12)</li> </ol>									

Certifications









## Miniature

Miniature photoelectric sensors are extremely compact, conveniently fitting into limited spaces with barrel and right angle housings.

Sensors have high-power performance for close range detection. Six sensing modes are available with an opposed mode sensing range up to 3 meters.

Series	Description	Max Sensing Range	Dimensions H x W x D	Protection Rating	Housing Material	Power Supply
	<b>VSM Series</b> Heavy-duty metal sensors that are compact and ideal for use in confined areas. Page 154	<b>Opposed:</b> 250 mm <b>Diffuse:</b> 200 mm	Varies by model	IP67; NEMA 6P	Stainless steel	10 to 30 V dc
	<b>VS1</b> Small, high performance sensor can easily be embedded into the application. Page 156	<b>Convergent:</b> 15 mm	25.7 x 8.3 x 11.6 mm	IP54, NEMA3	ABS/ polycarbonate	10 to 30 V dc
	<b>VS2</b> Ultra-thin VS2 miniature sensors are suited to work well in confined areas while providing high performance. Page 158	<b>Opposed:</b> 3 m <b>Convergent:</b> 30 mm	25.1 x 12 x 4.3 mm	IP67; NEMA 6P	ABS	10 to 30 V dc
	<b>VS3</b> Provides coaxial optics for close-range retro detection of the sensor. Page 160	<b>Coaxial Retro:</b> 250 mm <b>Coaxial Polar Retro:</b> 250 mm	25.4 x 9 x 15.6 mm	IP67; NEMA 6P	ABS	10 to 30 V dc

OTHER AVAILABLE MODELS



Q12 page 66

# VSM Series

## Self-Contained Metal Sensors



- Heavy-duty, compact, metal sensors that are ideal for use in confined areas.
- Sapphire lens
- Tough 300 series stainless steel body withstands a wide variety of chemicals and cutting fluids
- Smooth barrel models are ideal for hygienic applications that require frequent cleaning
- Advanced optical design provides high performance with repeatable sensing

### VSMQ (Flat-Pack, Side-Looker)

Infrared LED

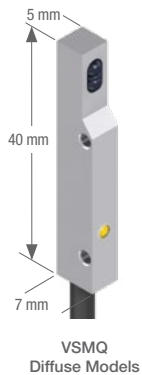

Sensing Mode	Range	Connection	Output Type	Models NPN	Models PNP
DIFFUSE	20-50 mm	2 m	LO	VSMQAN6CV20	VSMQAP6CV20
DIFFUSE	50-140 mm	2 m	LO	VSMQAN6CV50	VSMQAP6CV50
DIFFUSE	90-200 mm	2 m	LO	VSMQAN6CV90	VSMQAP6CV90

### VSM4 (4 mm Smooth Barrel)

Infrared LED

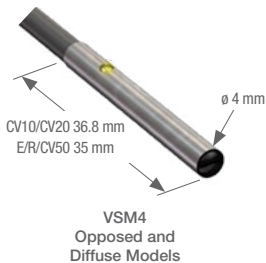

Sensing Mode	Range	Connection	Output Type	Models NPN	Models PNP
OPPOSED	250 mm	2 m	—	VSM46E Emitter	
	250 mm	3-Pin Pico QD	DO	VSM46EQ7 Emitter	
DIFFUSE	10-30 mm	2 m	LO	VSM4AN6CV10	VSM4AP6CV10
		3-Pin Pico QD		VSM4AN6CV10Q7	VSM4AP6CV10Q7
DIFFUSE	20-50 mm	2 m	LO	VSM4AN6CV20	VSM4AP6CV20
		3-Pin Pico QD		VSM4AN6CV20Q7	VSM4AP6CV20Q7
DIFFUSE	50-140 mm	2 m	LO	VSM4AN6CV50	VSM4AP6CV50
		3-Pin Pico QD		VSM4AN6CV50Q7	VSM4AP6CV50Q7

Connection options: A model with a QD requires a mating cordset.



VSM5 (5 mm Threaded Barrel)



Sensing Mode	Range	Connection	Output Type	Models NPN	Models PNP
OPPOSED	250 mm	2 m 3-Pin Pico QD	—	VSM56E Emitter VSM56EQ7 Emitter	
OPPOSED	250 mm	2 m 3-Pin Pico QD	DO	VSM5RN6R VSM5RN6RQ7	VSM5RP6R VSM5RP6RQ7
DIFFUSE	10-30 mm	2 m 3-Pin Pico QD	LO	VSM5AN6CV10 VSM5AN6CV10Q7	VSM5AP6CV10 VSM5AP6CV10Q7
DIFFUSE	20-50 mm	2 m 3-Pin Pico QD	LO	VSM5AN6CV20 VSM5AN6CV20Q7	VSM5AP6CV20 VSM5AP6CV20Q7
DIFFUSE	50-140 mm	2 m 3-Pin Pico QD	LO	VSM5AN6CV50 VSM5AN6CV50Q7	VSM5AP6CV50 VSM5AP6CV50Q7

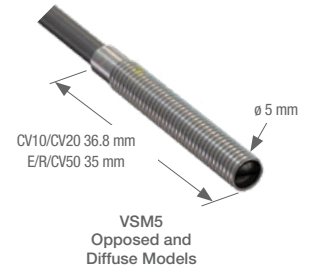

Connection options: A model with a QD requires a mating cordset.

**Pico QD (for Q models)**  
Straight connector models listed; for right-angle, **W** replaces **G** in the model number. (example, **PKW3M-2**)



**3-Pin**  
**PKG3M-2**  
2 m (6')  
**PKG3M-5**  
5 m (15')  
**PKG3M-9**  
9 m (30')



**SMBVSM4**

Additional cordsett information is available  
See page 758

Additional bracket information is available  
See page 722

VSM Specifications

Supply Voltage and Current	10 to 30 V dc (10% max. ripple)
Supply Protection Circuitry	Protected against reverse polarity and transient voltages
Output Configuration	<b>Single-output:</b> 1 NPN or 1 PNP, Light Operate (LO) or Dark Operate (DO), depending on model
Output Rating	100 mA max. <b>OFF-state leakage current:</b> less than 1 µA <b>ON-state saturation voltage:</b> less than 2 V @ 100 mA
Output Protection Circuitry	Protected against false pulse on power-up and continuous overload or short circuit of outputs Overload trip point ≥ 100 mA
Response Time	2.5 milliseconds
Delay at Power-up	20 milliseconds
Repeatability	1 millisecond
Indicators	<b>Yellow LED:</b> light sensed
Construction	300 series stainless steel with PVC cable <b>CV10 &amp; CV20:</b> sapphire lens <b>CV50 &amp; Opposed:</b> Glass lens
Environmental Rating	IP67
Connections	2 m PVC-jacketed cable or 3-pin Pico-style integral QD (Q7), depending on model. QD cordsets ordered separately.
Operating Conditions	Operating temperature: 0° to +55° C

Certification



# VS1 Series

## Miniature Self-Contained Sensors



- Small housing for powerful sensing performance in confined areas
- Available with 10 or 15 mm focal length
- Reliable sensing without adjustments

### Convergent VS1

➔ Red LED    ➔ Infrared LED

Sensing Mode	Range	Connection	Output Type	Models NPN	Models PNP
 CONVERGENT	10 mm focus	2 m	LO	VS1AN5CV10	VS1AP5CV10
		3-Pin Pico Pigtail QD		VS1AN5CV10Q	VS1AP5CV10Q
		2 m	DO	VS1RN5CV10	VS1RP5CV10
		3-Pin Pico Pigtail QD		VS1RN5CV10Q	VS1RP5CV10Q
 CONVERGENT	15 mm focus	2 m	LO	VS1AN5CV20	VS1AP5CV20
		3-Pin Pico Pigtail QD		VS1AN5CV20Q	VS1AP5CV20Q
		2 m	DO	VS1RN5CV20	VS1RP5CV20
		3-Pin Pico Pigtail QD		VS1RN5CV20Q	VS1RP5CV20Q
 CONVERGENT	10 mm focus	2 m	LO	VS1AN5C10	VS1AP5C10
		3-Pin Pico Pigtail QD		VS1AN5C10Q	VS1AP5C10Q
		2 m	DO	VS1RN5C10	VS1RP5C10
		3-Pin Pico Pigtail QD		VS1RN5C10Q	VS1RP5C10Q
 CONVERGENT	15 mm focus	2 m	LO	VS1AN5C20	VS1AP5C20
		3-Pin Pico Pigtail QD		VS1AN5C20Q	VS1AP5C20Q
		2 m	DO	VS1RN5C20	VS1RP5C20
		3-Pin Pico Pigtail QD		VS1RN5C20Q	VS1RP5C20Q

Connection options: A model with a QD requires a mating cordset.  
 For 9 m cable, add suffix W/30 to the 2 m model number (example, VS1AN5CV10 W/30).



**3-Pin**  
**PKG3M-2**  
 2 m (6')  
**PKG3M-5**  
 5 m (15')  
**PKG3M-9**  
 9 m (30')

**Pico QD (for Q models)**  
 Straight connector models listed; for right-angle, **W** replaces **G** in the model number. (example, **PKW3M-2**)

**Reflectors**



Additional information is available  
 See page 790

Additional cordset information is available  
 See page 758



**SMBVS1T**



**SMBVS1TC**



**SMBVS1S**



**SMBVS1SC**

Additional bracket information is available  
 See page 724



**VS1 Specifications**

<b>Supply Voltage and Current</b>	10 to 30 V dc (10% max. ripple) at less than 25 mA (exclusive of load)
<b>Supply Protection Circuitry</b>	Protected against reverse polarity and transient voltages
<b>Output Configuration</b>	Solid-state switch NPN (current sinking) or PNP (current sourcing), depending on model Light Operate (LO) or Dark Operate (DO) models
<b>Output Rating</b>	50 mA max. <b>OFF-state leakage current:</b> less than 1 µA at 24 V dc <b>ON-state saturation voltage:</b> less than 0.25 V at 10 mA dc; less than 0.5 V at 50 mA dc
<b>Output Protection Circuitry</b>	Protected against false pulse on power-up and continuous overload or short circuit of outputs Overload trip point ≥ 100 mA
<b>Output Response Time</b>	1 millisecond ON/OFF
<b>Repeatability</b>	250 microseconds
<b>Indicators</b>	<b>Two LEDs: Solid Green:</b> power ON <b>Solid Yellow:</b> light sensed <b>Flashing Green:</b> output over loaded <b>Flashing Yellow:</b> marginal excess gain
<b>Construction</b>	Black ABS/polycarbonate housing with clear acrylic lens
<b>Environmental Rating</b>	IP54; NEMA 3
<b>Connections</b>	2 m or 9 m attached cable, or 150 mm pigtail with 3-pin Pico-style quick-disconnect fitting. QD cables are ordered separately.
<b>Operating Conditions</b>	<b>Temperature:</b> -20° to +55° C <b>Relative humidity:</b> 80% at 50° C (non-condensing)
<b>Application Notes</b>	M2 stainless steel mounting hardware is included. Optional mounting brackets are available.

**Certifications**



# VS2 Series

## Flat Pack Miniature Sensors



- Offers flat-front mounting or optional bracket
- Reliable sensing without adjustments
- Models available in opposed or convergent modes

### Opposed VS2

➔ Visible Red LED   ➔ Infrared LED

Sensing Mode	Range	Connection	Output Type	Models NPN†	Models PNP†
<p>OPPOSED</p>	Optimum up to 600 mm, 1.2 m max.	2 m	—	VS25EV Emitter	
		3-Pin Pico Pigtail QD	LO	VS25EVQ Emitter	
		2 m		VS2AN5R	VS2AP5R
		3-Pin Pico Pigtail QD	VS2AN5RQ	VS2AP5RQ	
<p>OPPOSED</p>	3.0 m	2 m	DO	VS2RN5R	VS2RP5R
		3-Pin Pico Pigtail QD		VS2RN5RQ	VS2RP5RQ
		2 m	—	VS25E Emitter	
		3-Pin Pico Pigtail QD	VS25EQ Emitter		
		2 m	LO	VS2AN5R	VS2AP5R
		3-Pin Pico Pigtail QD	VS2AN5RQ	VS2AP5RQ	
<p>OPPOSED</p>	3.0 m	2 m	DO	VS2RN5R	VS2RP5R
		3-Pin Pico Pigtail QD		VS2RN5RQ	VS2RP5RQ

### Convergent VS2

➔ Visible Red LED

Sensing Mode	Range	Connection	Output Type	Models NPN†	Models PNP†
<p>CONVERGENT</p>	15 mm ±5 mm	2 m	LO	VS2AN5CV15	VS2AP5CV15
		3-Pin Pico Pigtail QD		VS2AN5CV15Q	VS2AP5CV15Q
		2 m	DO	VS2RN5CV15	VS2RP5CV15
		3-Pin Pico Pigtail QD		VS2RN5CV15Q	VS2RP5CV15Q
<p>CONVERGENT</p>	30 mm ±10 mm	2 m	LO	VS2AN5CV30	VS2AP5CV30
		3-Pin Pico Pigtail QD		VS2AN5CV30Q	VS2AP5CV30Q
		2 m	DO	VS2RN5CV30	VS2RP5CV30
		3-Pin Pico Pigtail QD		VS2RN5CV30Q	VS2RP5CV30Q

➔ Connection options: A model with a QD requires a mating cordset.  
 For 9 m cable, add suffix W/30 to the 2 m model number (example, VS2RP5R W/30).  
 † Opposed-mode models also sold as pairs. Contact factory for more information 1-888-373-6767.



**3-Pin**  
**PKG3M-2**  
 2 m (6')  
**PKG3M-5**  
 5 m (15')  
**PKG3M-9**  
 9 m (30')

**Pico QD (for Q models)**  
 Straight connector models listed;  
 for right-angle, **W** replaces **G** in  
 the model number.  
 (example, **PKW3M-2**)

Additional cordset information is available  
 See page 758

**Reflectors**



Additional information is available  
 See page 790

**Appartures**



Additional information is available  
 See page 816



**SMBVS2RA**

Additional bracket information is available  
 See page 724



**Opposed Models**  
 Suffix E and R



**Convergent Models**  
 Suffix C

**VS2 Specifications**

<b>Supply Voltage and Current</b>	10 to 30 V dc (10% max. ripple) <b>Emitter:</b> 25 mA (visible red); 30 mA (infrared) <b>Receiver (Convergent):</b> at less than 25 mA (exclusive of load)
<b>Supply Protection Circuitry</b>	Protected against reverse polarity and transient voltages
<b>Output Configuration</b>	Solid-state switch NPN (current sinking) or PNP (current sourcing), depending on model Light Operate (LO) or Dark Operate (DO), depending on model
<b>Output Rating</b>	50 mA max. <b>OFF-state leakage current:</b> less than 1 $\mu$ A at 24 V dc <b>ON-state saturation voltage:</b> less than 0.25 V at 10 mA dc; less than 0.5 V at 50 mA dc
<b>Output Protection Circuitry</b>	Protected against false pulse on power-up and continuous overload or short circuit of outputs Overload trip point $\geq$ 100 mA
<b>Output Response Time</b>	<b>Opposed:</b> 1 millisecond ON; 0.5 millisecond OFF <b>Convergent:</b> 1 millisecond ON; OFF
<b>Delay at Power-up</b>	Maximum 100 millisecond (opposed) and 150 millisecond (convergent); output does not conduct during this time
<b>Repeatability</b>	<b>Opposed:</b> 100 microseconds <b>Convergent:</b> 160 microseconds
<b>Indicators</b>	Two LEDs: <b>Solid Green:</b> power ON <b>Flashing Green:</b> output overload <b>Solid Yellow:</b> light sensed <b>Flashing Yellow (opposed mode only):</b> marginal excess gain
<b>Construction</b>	<b>Opposed:</b> Black ABS housing with clear MABS lens <b>Convergent:</b> Black ABS housing with acrylic lens
<b>Environmental Rating</b>	IEC IP67; NEMA 6
<b>Connections</b>	2 m or 9 m attached cable or 150 mm pigtail with 3-pin Pico-style quick-disconnect fitting. QD cordsets are ordered separately.
<b>Operating Conditions</b>	<b>Temperature:</b> -20° to +55° C <b>Relative humidity:</b> 80% at 50° C (non-condensing)
<b>Vibration and Mechanical Shock</b>	<b>Vibration:</b> All models meet IEC 60068-2-6, IEC 60947-5-2, UL491 Section 40, MIL-STD-202F Method 201A; 10 to 60 Hz, 0.5 mm peak to peak All models meet IEC 60068-2-27, IEC 60947-5-2; 30g peak acceleration, 11 millisecond pulse duration, half-sine wave pulse shape
<b>Application Notes</b>	M2 stainless steel mounting hardware is included. Optional mounting brackets are available.

**Certifications**



# VS3 Series

## Miniature Sensors with Advanced Optics



- Reliable sensing without adjustments
- Uses coaxial optics to eliminate blind areas at close range
- Accurately detects shiny objects
- Visible sensing beam for easy alignment

### Coaxial & Coaxial Polar Retro VS3

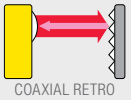
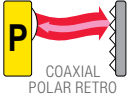
Sensing Mode	Range <sup>†</sup>	Connection	Output Type	Models NPN	Models PNP
 COAXIAL RETRO	250 mm	2 m	LO	VS3AN5XLV	VS3AP5XLV
		3-Pin Pico QD		VS3AN5XLVQ	VS3AP5XLVQ
		2 m	DO	VS3RN5XLV	VS3RP5XLV
		3-Pin Pico QD		VS3RN5XLVQ	VS3RP5XLVQ
 COAXIAL POLAR RETRO	250 mm	2 m	LO	VS3AN5XLP	VS3AP5XLP
		3-Pin Pico QD		VS3AN5XLPQ	VS3AP5XLPQ
		2 m	DO	VS3RN5XLP	VS3RP5XLP
		3-Pin Pico QD		VS3RN5XLPQ	VS3RP5XLPQ

 Connection options: A model with a QD requires a mating cordset .

For 9 m cable, add suffix W/30 to the 2 m model number (example, VS3AN5XLV W/30).

<sup>†</sup> Retroreflective range is specified using one model BRT-32X20AM retroreflector. Actual sensing range may differ, depending on efficiency and reflective area of the retroreflector in use. See accessories for more information.



3-Pin

**Pico QD (for Q models)**  
 Straight connector models listed;  
 for right-angle, **W** replaces **G** in  
 the model number.  
 (example, **PKW3M-2**)

- PKG3M-2**  
2 m (6')
- PKG3M-5**  
5 m (15')
- PKG3M-9**  
9 m (30')

Additional cordset information is available  
 See page 758

Reflectors



Additional information is available  
 See page 790



Non-Polarized Retroreflective Models  
 Suffix LV



SMBVS3S



SMBVS3T

Additional bracket information is available  
 See page 724

VS3 Specifications

<b>Supply Voltage and Current</b>	10 to 30 V dc (10% max. ripple) at less than 25 mA (exclusive of load)
<b>Supply Protection Circuitry</b>	Protected against reverse polarity and transient voltages
<b>Output Configuration</b>	Solid-state switch NPN (current sinking) or PNP (current sourcing), depending on model Light Operate (LO) or Dark Operate (DO), depending on model
<b>Output Protection Circuitry</b>	Protected against false pulse on power-up and continuous overload or short circuit of outputs Overload trip point $\geq$ 100 mA
<b>Output Rating</b>	50 mA max. <b>OFF-state leakage current:</b> less than 1 $\mu$ A at 24 V dc <b>ON-state saturation voltage:</b> less than 0.25 V at 10 mA dc; less than 0.5 V at 50 mA dc
<b>Output Response Time</b>	1 millisecond ON/OFF
<b>Delay at Power-up</b>	150 millisecond; output does not conduct during this time
<b>Repeatability</b>	160 microseconds
<b>Indicators</b>	<b>Two LEDs:</b> <b>Solid Green:</b> power ON <b>Flashing Green:</b> output over loaded <b>Solid Yellow:</b> light sensed
<b>Construction</b>	<b>Non-polarized Retroreflective:</b> Black ABS housing with acrylic lens <b>Polarized Retroreflective:</b> Black ABS housing with glass lens and acrylic cover
<b>Environmental Rating</b>	IEC IP67; NEMA 6
<b>Connections</b>	2 m or 9 m attached cable, or 3-pin Pico-style quick-disconnect fitting. QD cordsets are ordered separately.
<b>Operating Conditions</b>	<b>Temperature:</b> -20° to +55° C <b>Relative humidity:</b> 80% at 50° C (non-condensing)
<b>Vibration and Mechanical Shock</b>	<b>Vibration:</b> All models meet IEC 60068-2-6, IEC 60947-5-2, UL491 Section 40, MIL-STD-202F Method 201A; 10 to 60 Hz, 0.5 mm peak to peak <b>Shock:</b> All models meet IEC 60068-2-27, IEC 60947-5-2; 30g peak acceleration, 11 millisecond pulse duration, half-sine wave pulse shape
<b>Application Notes</b>	M3 stainless steel mounting hardware is included. Optional mounting brackets are available.

Certifications











## Fiber Optics

Fiber optic cables are ideal for harsh conditions including high vibration, extreme heat, noisy, wet, corrosive or explosive environments. Fiber optic sensors have thin profiles, allowing for close mounting of multiple units and mounting in confined areas. Sensors can be positioned precisely where needed with flexible fibers.

Series	Description	Output Response Time	Dimensions H x W x D	Housing Material	Power Supply
	<b>DF-G3</b> Long-range easy to read dual display fiber amplifier page 164	500 $\mu$ s varies by model	33.0 x 72.0 x 10.0 mm	Thermoplastic	<b>NPN/PNP models:</b> 10 to 30 V dc <b>IO-Link models:</b> 18 to 30 V dc
	<b>DF-G2</b> High-speed easy to read dual display fiber amplifier page 166	10 $\mu$ s (varies by model)	33.0 x 72.0 x 10.0 mm	Thermoplastic	<b>NPN/PNP models:</b> 10 to 30 V dc <b>IO-Link models:</b> 18 to 30 V dc
	<b>DF-G1</b> Easy to read dual display fiber amplifier page 168	<b>High Speed:</b> 200 $\mu$ s <b>Long Range:</b> 2 ms <b>Extra Long Range:</b> 5 ms	33.0 x 72.0 x 10.0 mm	Thermoplastic	<b>NPN/PNP models:</b> 10 to 30 V dc <b>IO-Link models:</b> 18 to 30 V dc
	<b>D10</b> Advanced fiber optic amplifier page 172	varies by model	35.9 x 68.1 x 10.0 mm	Thermoplastic	12 to 24 V dc
	Plastic Fibers page 174				
	Glass Fibers page 192				

OTHER AVAILABLE MODELS



R55F see website

# DF-G3 Series

## Long-range Fiber Optic Amplifiers



- World-class long-range sensing capability, more than 3 m (10 ft) with opposed mode fibers
- Easy to read dual digital displays show both signal level and threshold simultaneously
- Cross-talk avoidance function allows seven inspections in dense sensing point applications
- Models with IO-Link enable a point-to-point communication link between a master device and a sensor, facilitating remote monitoring, teaching, and configuration
- Operator control of the sensitivity (hysteresis) provides additional detection sensitivity, or a stabilized output depending on the application details

### IO-Link DF-G3

Sensing Beam Color	Range*	Connection	Output	Models
Visible Red, 635 nm	3,000 mm	2 m	Channel1: IO-Link, push/pull Channel 2: PNP only output, or input	DF-G3-KD-2M
Infrared, 850 nm**	6,000 mm	2 m	Channel1: IO-Link, push/pull Channel 2: PNP only output, or input	DF-G3IR-KD-2M

### Single Output DF-G3

Sensing Beam Color	Range*	Connection	NPN Models	PNP Models
Visible Red	3,000 mm	2 m	DF-G3-NS-2M	DF-G3-PS-2M
Infrared, 850 nm**	6,000 mm	2 m	DF-G3IR-NS-2M	DF-G3IR-PS-2M

### Dual Output DF-G3

Sensing Beam Color	Range*	Connection	NPN Models	PNP Models
Visible Red	3,000 mm	2 m	DF-G3-ND-2M	DF-G3-PD-2M
Infrared, 850 nm**	6,000 mm	2 m	DF-G3IR-ND-2M	DF-G3IR-PD-2M

### Analog DF-G3

Sensing Beam Color	Range*	Connection	Supply Voltage	NPN Models	PNP Models
Visible Red	3,000 mm	2 m	Voltage: 12-30 V DC	DF-G3-NU-2M	DF-G3-PU-2M
			Current: 10-30 V DC	DF-G3-NI-2M	DF-G3-PI-2M
Infrared, 850 nm**	6,000 mm	2 m	Voltage: 12-30 V DC	DF-G3IR-NU-2M	DF-G3IR-PU-2M
			Current: 10-30 V DC	DF-G3IR-NI-2M	DF-G3IR-PI-2M

For more specifications see page 169

 Connection Option: A model with a QD requires a mating cordset. (see page 169)

\* Excess gain = 1, Long Range response speed, opposed mode sensing.

\*\* IR models require T5 terminated glass fiber optic cables

# DF-G3 Series

## Water Detection Fiber Optic Amplifiers



- 1450 nm infrared wavelength to enhance contrast of clear liquids
- Reliable detection of presence or absence of water-based liquids
- Easy to read dual digital displays show both signal level and threshold simultaneously
- Cross-talk avoidance function allows seven inspections in dense sensing point applications
- Models with IO-Link enable a point-to-point communication link between a master device and a sensor, facilitating remote monitoring, teaching, and configuration
- Cordsets and brackets see page 169

### Single Output DF-G3

Sensing Beam Color	Range*	Connection	NPN Models	PNP Models
Long Infrared, 1450 nm**	900 mm	2 m	DF-G3LIR-NS-2M	DF-G3LIR-PS-2M

### Dual Output DF-G3

Sensing Beam Color	Range*	Connection	NPN Models	PNP Models
Long Infrared, 1450 nm**	900 mm	2 m	DF-G3LIR-ND-2M	DF-G3LIR-PD-2M

### Analog DF-G3

Sensing Beam Color	Range*	Connection	Supply Voltage	NPN Models	PNP Models
Long Infrared, 1450 nm**	900 mm	2 m	Voltage: 12-30 V DC	DF-G3LIR-NU-2M	DF-G3LIR-PU-2M
			Current: 10-30 V DC	DF-G3LIR-NI-2M	DF-G3LIR-PI-2M

For more specifications see page 169

 Connection Option: A model with a QD requires a mating cordset. (see page 169)

\* Excess gain = 1, Long Range response speed, opposed mode sensing.

\*\* IR models require T5 terminated glass fiber optic cables

# DF-G2 Series

## High-Speed *Expert*™ Fiber Optic Amplifiers



- The high speed DF-G2 fiber amplifiers now offer several LED colors to maximize contrast in challenging low-contrast applications
- Best in Class response time
- Programming via displays and switches/buttons or remote input teach wire
- *Expert* TEACH and SET methods ensure optimal gain and threshold for all applications, especially low contrast applications
- Cross talk avoidance algorithm allows two sensors to operate in close proximity for many applications

### IO-Link DF-G2

Sensing Beam Color	Range	Connection	Output	Models
Visible Red, 635 nm	1,100 mm	2 m	Channel 1: IO-Link, push/pull Channel 2: PNP only output, or input	DF-G2-KD-2M
Infrared, 850 nm*	2,100 mm	2 m	Channel 1: IO-Link, push/pull Channel 2: PNP only output, or input	DF-G2IR-KD-2M

### DF-G2

Sensing Beam Color	Range	Connection	NPN Models	PNP Models
Visible Red	Range varies by response speed and fiber optics used	2 m	DF-G2-NS-2M	DF-G2-PS-2M



### Multiple Color DF-G2

Sensing Beam Color	Range	Connection	NPN Models	PNP Models
Broad Spectrum White	50% of Visible Red Range	2 m	DF-G2W-NS-2M	DF-G2W-PS-2M
Visible Green	60% of Visible Red Range	2 m	DF-G2G-NS-2M	DF-G2G-PS-2M
Visible Blue	70% of Visible Red Range	2 m	DF-G2B-NS-2M	DF-G2B-PS-2M
Infrared*	190% of Visible Red Range	2 m	DF-G2IR-NS-2M	DF-G2IR-PS-2M

### DF-G2 Multiple color

Multiple LED color options available.

For more specifications see page 170.

 Connection options: A model with a QD requires a mating cordset (see page 169).

For 9 m cable, change the suffix 2M to 9M in the 2 m model number (example, DF-G2-NS-9M).

For M8 pico pigtail, change the suffix 2M to Q3 in the 2 m model number (example, DF-G2-NS-Q3).

For M12 euro pigtail, change the suffix 2M to Q5 in the 2 m model number (example, DF-G2-NS-Q5).

\* IR models require T5 terminated glass fiber optic cables

# DF-G2 Series

## Small Object Fiber Optic Amplifiers



- The DF-G2 Series uses Banner's unique firmware designed to achieve accurate, high speed, low contrast performance for small object detection applications
- Percent-based threshold selectable from 2% to 50% for sensitivity adjustment
- Automatic Gain Compensation (AGC) algorithm compensates for dust build-up on fiber optics to extend counting cycle and maintain count accuracy
- Intelligent Dynamic Event Stretcher (DES) minimizing chance for double-counting, even with non-uniform objects (i.e. gel caps, washers, etc.)

### DF-G2

Sensing Beam Color	Range	Connection	NPN Models	PNP Models
Visible Red, 635 nm	Range varies by response speed and fiber optics used	2 m	DF-G2-NC-2M	DF-G2-PC-2M

### Fiber Optic Arrays for DF-G2

Sensing Beam Color	Window Size	Fiber Exit	Minimum Object Size	Model
Visible Red, 635 nm	10 x 25 mm	Side Exit	1.5 mm	PFCVA-10X25-S
		End Exit		PFCVA-10X25-E
Visible Red, 635 nm	25 x 25 mm	Side Exit	3 mm	PFCVA-25X25-S
		End Exit		PFCVA-25X25-E
Visible Red, 635 nm	34 x 25 mm	Side Exit	4 mm	PFCVA-34X25-S
		End Exit		PFCVA-34X25-E



DF-G2 and array fibers

Multiple array fiber models available.

For more specifications see page 170.

Connection options: A model with a QD requires a mating cordset (see page 169)

For 9 m cable, change the suffix 2M to 9M in the 2 m model number (example, DF-G2-NC-9M).

# DF-G1 Series

## Expert™ Dual-Display Fiber Optic Amplifiers



- The DF-G1 Series has a simple user interface to ensure easy sensor set-up and programming via displays and switches/buttons, remote input teach wire or IO-Link
- End user has full control over operating parameters, including Light/Dark Operate, output timing functions, gain level and response speed
- Cross talk avoidance algorithm allows multiple sensors to operate in close proximity
- Light receiver models detect light emission from a wide variety of sources

### IO-Link DF-G1

Sensing Beam Color	Range	Connection	Output	Models
Visible Red, 660 nm	Range varies by Speed Selection used and with fiber optics used. See fibers section on page 174 or reference website for range information.	2 m	Channel1: IO-Link, push/pul Channel 2: PNP only output, or input	DF-G1-KS-2M

### DF-G1

Sensing Beam Color	Range	Connection	NPN Models	PNP Model
Visible Red, 660 nm	Range varies by Speed Selection used and with fiber optics used. See fibers section on page 174 or reference website for range information.	2 m	DF-G1-NS-2M	DF-G1-PS-2M

### Light Receiver DF-G1

Sensing Beam Color	Range	Connection	NPN Models	PNP Model
Visible Red, 660 nm	Range varies by response speed used, gain setting, target light source intensity, ambient light level and with fiber optics used. See fibers section on page 174 or reference website for range information.	2 m	DF-G1-NR-2M	DF-G1-PR-2M

 Connection options: A model with a QD requires a mating cordset

For 9 m cable, change the suffix 2M to 9M in the 2 m model number (example, DF-G1-NS-9M).  
 For M8 Pico pigtail change the suffix 2M to Q3 in the 2 m model number (example, DF-G1-NS-Q3).  
 For M12 Euro pigtail change the suffix 2M to Q5 in the 2 m model number (example, DF-G1-NS-Q5).



**Euro QD**  
(for ..Q8 or ..Q5 models)  
Straight connector models listed; for right-angle, add **RA** to the end of the model number (example, **MQDC-406RA**)



**4-Pin**  
**MQDC-406**  
2 m (6')  
**MQDC-415**  
5 m (15')  
**MQDC-430**  
9 m (30')

**Pico QD**  
(for Q7 models)  
Straight snap-on connector

**Pico QD (for Q7 models)**  
Right-angle snap-on connector



**4-Pin**  
**PKG4-2**  
2 m (6')  
**PKW4Z-2**  
2 m (6')

Additional cordset information is available  
See page 758



DIN-35..



SA-DIN-BRACKET

Mounting Clamp



SA-DIN-CLAMP

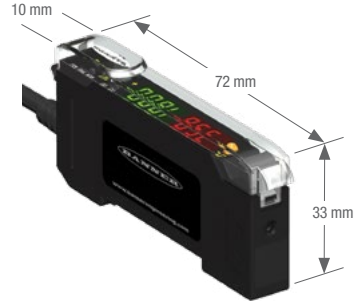



Additional bracket information is available  
See page 730



DF-G1 Specifications

Supply Voltage and Current	<b>NPN/PNP Models:</b> 10 to 30 V dc (10% max ripple) <b>Standard Mode:</b> 960 mW, Current consumption < 40 mA @ 24 V dc	<b>IO-Link Models:</b> 18 to 30 V dc (10% max ripple) <b>ECO Display Mode:</b> 720 mW, Current consumption < 30 mA @ 24 V dc
Supply Protection Circuitry	Protected against reverse polarity, over voltage, and transient voltages	
Output Configuration	<b>NPN/PNP Models:</b> 1 current sourcing (PNP) or 1 current sinking (NPN) output, depending on model <b>IO-Link Models:</b> 1 push-pull and 1 PNP (complementary outputs)	
Output Rating	100 mA max. load (derate 1 mA per °C above 30 °C) <b>OFF-state leakage current:</b> NPN/PNP: < 5 µA at 30 V dc IO-Link: < 50 µA at 30 V dc <b>ON-state saturation voltage:</b> NPN: < 1.5 V PNP: < 2 V IO-Link: < 2 V	
Output Protection Circuitry	Protected against output short-circuit, continuous overload, transient over-voltages, and false pulse on power up	
Output Response Time	<b>High Speed:</b> 200 us <b>Standard:</b> 500 us <b>Long Range:</b> 2 ms <b>Extra Long Range:</b> 5 ms <b>Light receiver models:</b> 50 ms, 150 ms	
Delay at Power-up	500 milliseconds max.; outputs do not conduct during this time	
Adjustments	3-way RUN/PRG/ADJ Mode Switch 2-way LO/DO Switch 3-way +/SET/- Rocker Button See datasheet for detailed information	
Indicators	<b>Red 4-digit Display:</b> Signal Level <b>Green 4-digit Display:</b> Threshold <b>Yellow LED:</b> Output conducting (In Program Mode, Red and Green displays are used for programming menus)	
Construction	Black ABS/polycarbonate alloy (UL94 V-0 rated) housing, clear polycarbonate cover	
Environmental Rating	IEC IP50, NEMA 1	
Operating Conditions	<b>Temperature:</b> -10 to +55 °C <b>Storage:</b> -20 to +85 °C <b>Relative Humidity:</b> 90% @ 60 °C (non-condensing)	
Certifications		

## DF-G2 Specifications

Supply Voltage and Current	10 to 30 V dc (10% max ripple)																										
Supply Protection Circuitry	Protected against reverse polarity, over voltage, and transient voltages <b>Standard display mode:</b> 960 mW, Current consumption less than 40 mA at 24 V dc <b>ECO display mode:</b> 720 mW, Current consumption less than 30 mA at 24 V dc																										
Output Configuration	<b>NPN/PNP Models:</b> 1 current sourcing (PNP) or 1 current sinking (NPN) output, depending on model, plus 1 Health Mode output																										
Output Rating	100 mA max. load (derate 1 mA per °C above 30 °C) <b>OFF-state leakage current:</b> NPN/PNP: < 5 µA at 30 V dc <b>ON-state saturation voltage:</b> NPN: < 1.5 V PNP: < 2 V																										
Output Protection Circuitry	Protected against output short-circuit, continuous overload, transient over-voltages, and false pulse on power up																										
Sensing Beam	<b>DF-G2:</b> Visible red, 635 nm <b>DF-G2W:</b> Broad spectrum white, 450 to 650 nm <b>DF-G2B:</b> Visible blue, 470 nm <b>DF-G2G:</b> Visible green, 525 nm <b>DF-G2IR:</b> Infrared, 850 nm																										
Output Response Time	<table border="0"> <tr> <td><b>Super High Speed:</b> 10 µs</td> <td><b>High Speed:</b> 15 µs</td> </tr> <tr> <td><b>Fast:</b> 50 µs</td> <td><b>Standard:</b> 250 µs</td> </tr> <tr> <td><b>Medium Range:</b> 500 µs</td> <td><b>Long Range:</b> 1000 µs</td> </tr> <tr> <td colspan="2"><b>Long Range with immunity to Energy Efficient Lights:</b> 2000 µs</td> </tr> <tr> <td><b>Super High Speed:</b> 10 µs</td> <td><b>High Speed:</b> 15 µs</td> </tr> <tr> <td><b>Fast:</b> 50 µs</td> <td><b>Standard:</b> 250 µs</td> </tr> <tr> <td><b>Medium Range:</b> 500 µs</td> <td><b>Long Range:</b> 1000 µs</td> </tr> <tr> <td colspan="2"><b>DF-G2 Small Object Counter:</b> 25 µs</td> </tr> <tr> <td></td> <td>50 µs</td> </tr> <tr> <td></td> <td>150 µs</td> </tr> <tr> <td></td> <td>250 µs</td> </tr> <tr> <td></td> <td>500 µs</td> </tr> </table>			<b>Super High Speed:</b> 10 µs	<b>High Speed:</b> 15 µs	<b>Fast:</b> 50 µs	<b>Standard:</b> 250 µs	<b>Medium Range:</b> 500 µs	<b>Long Range:</b> 1000 µs	<b>Long Range with immunity to Energy Efficient Lights:</b> 2000 µs		<b>Super High Speed:</b> 10 µs	<b>High Speed:</b> 15 µs	<b>Fast:</b> 50 µs	<b>Standard:</b> 250 µs	<b>Medium Range:</b> 500 µs	<b>Long Range:</b> 1000 µs	<b>DF-G2 Small Object Counter:</b> 25 µs			50 µs		150 µs		250 µs		500 µs
<b>Super High Speed:</b> 10 µs	<b>High Speed:</b> 15 µs																										
<b>Fast:</b> 50 µs	<b>Standard:</b> 250 µs																										
<b>Medium Range:</b> 500 µs	<b>Long Range:</b> 1000 µs																										
<b>Long Range with immunity to Energy Efficient Lights:</b> 2000 µs																											
<b>Super High Speed:</b> 10 µs	<b>High Speed:</b> 15 µs																										
<b>Fast:</b> 50 µs	<b>Standard:</b> 250 µs																										
<b>Medium Range:</b> 500 µs	<b>Long Range:</b> 1000 µs																										
<b>DF-G2 Small Object Counter:</b> 25 µs																											
	50 µs																										
	150 µs																										
	250 µs																										
	500 µs																										
Repeatability	<table border="0"> <tr> <td><b>Super High Speed:</b> 5 µs</td> <td><b>High Speed:</b> 5 µs</td> </tr> <tr> <td><b>Fast:</b> 12 µs</td> <td><b>Standard:</b> 50 µs</td> </tr> <tr> <td><b>Medium Range:</b> 80 µs</td> <td><b>Long Range:</b> 165 µs</td> </tr> <tr> <td colspan="2"><b>Long Range with immunity to Energy Efficient Lights:</b> 165 µs</td> </tr> <tr> <td colspan="2"><b>DF-G2 Small Object Counter:</b> 12 µs</td> </tr> <tr> <td></td> <td>12 µs</td> </tr> <tr> <td></td> <td>30 µs</td> </tr> <tr> <td></td> <td>50 µs</td> </tr> <tr> <td></td> <td>80 µs</td> </tr> </table>			<b>Super High Speed:</b> 5 µs	<b>High Speed:</b> 5 µs	<b>Fast:</b> 12 µs	<b>Standard:</b> 50 µs	<b>Medium Range:</b> 80 µs	<b>Long Range:</b> 165 µs	<b>Long Range with immunity to Energy Efficient Lights:</b> 165 µs		<b>DF-G2 Small Object Counter:</b> 12 µs			12 µs		30 µs		50 µs		80 µs						
<b>Super High Speed:</b> 5 µs	<b>High Speed:</b> 5 µs																										
<b>Fast:</b> 12 µs	<b>Standard:</b> 50 µs																										
<b>Medium Range:</b> 80 µs	<b>Long Range:</b> 165 µs																										
<b>Long Range with immunity to Energy Efficient Lights:</b> 165 µs																											
<b>DF-G2 Small Object Counter:</b> 12 µs																											
	12 µs																										
	30 µs																										
	50 µs																										
	80 µs																										
Construction	Black ABS/polycarbonate alloy (UL94 V-0 rated) housing, clear polycarbonate cover																										
Environmental Rating	IEC IP50, NEMA 1																										
Operating Conditions	Temperature: -10 to +55 °C	Storage: -20 to +85 °C	Relative Humidity: 90% @ 60 °C (non-condensing)																								
Certifications	 																										

## DF-G3 Specifications

Supply Voltage and Current	<b>NPN/PNP Models:</b> 10 to 30 V dc (10% max ripple) <b>Voltage output models:</b> 12 to 30 V dc (10% max ripple) <b>Standard Mode:</b> 960 mW, Current consumption < 40 mA @ 24 V dc	<b>IO-Link Models:</b> 18 to 30 V dc (10% max ripple) <b>Current output models:</b> 10 to 30 V dc (10% max ripple) <b>ECO Display Mode:</b> 720 mW, Current consumption < 30 mA @ 24 V dc
Supply Protection Circuitry	Protected against reverse polarity, over voltage, and transient voltages	
Sensing Beam	<b>DF-G3:</b> Visible red, 635 nm <b>DF-G3IR:</b> Infrared, 850 nm <b>DF-G3LIR:</b> Long Infrared, 1450 nm	
Output Configuration	<b>NPN/PNP Models:</b> 1 current sourcing (PNP) or 1 current sinking (NPN) output, depending on model <b>IO-Link Models:</b> 1 push-pull and 1 PNP (complementary outputs) <b>Voltage output models:</b> 1 analog voltage output (user configurable as 1 V to 5 V or 0 V to 10 V) with 1 current sinking (NPN) or 1 current sourcing (PNP) discrete output <b>Current output models:</b> 1 analog current output (4 mA to 20 mA) with 1 current sinking (NPN) or 1 current sourcing (PNP) discrete output	
Output Rating	100 mA max. load (derate 1 mA per °C above 30 °C) <b>OFF-state leakage current:</b> <b>NPN/PNP/current:</b> < 5 µA at 30 V dc <b>IO-Link:</b> < 50 µA at 30 V dc  <b>ON-state saturation voltage:</b> <b>NPN:</b> < 1.5 V <b>PNP:</b> < 2 V <b>IO-Link:</b> < 2 V	
Output Protection Circuitry	Protected against output short-circuit, continuous overload, transient over-voltages, and false pulse on power up	
Output Response Time	<b>High Speed:</b> 500 us <b>Fast:</b> 1000 us <b>Standard:</b> 2 ms <b>Long Range:</b> 8 ms <b>Extra Long Range:</b> 24 ms	
Delay at Power-up	500 milliseconds max.; outputs do not conduct during this time	
Indicators	<b>Red 4-digit Display:</b> Signal Level <b>Green 4-digit Display:</b> Threshold <b>Yellow LED:</b> Output conducting (In Program Mode, Red and Green displays are used for programming menus)	
Construction	Black ABS/polycarbonate alloy (UL94 V-0 rated) housing, clear polycarbonate cover	
Environmental Rating	IEC IP50, NEMA 1	
Operating Conditions	<b>Temperature:</b> -10 to +55 °C <b>Storage:</b> -20 to +85 °C	<b>Relative Humidity:</b> 50% @ +50 °C (non-condensing)
Certifications	  	

# D10 Series

## High-Speed *Expert*™ Fiber Optic Amplifiers



- Available with visible red or green beam
- Available in Light or Dark Operate
- Includes specially designed models for reliable detection of objects as small as 1.5 mm
- Features bussable models for side-by-side mounting and simplified wiring of up to 16 sensors
- Features thin 10 mm housing for standard 35 mm DIN-rail mounting

### D10

Sensing Beam Color	Range	Connection	Output Type	Response Speed	Models
Visible Red	Range varies by Power Level/Speed Selection used and with fiber optics used. See fibers section on page 174 or reference datasheet for range information.	2 m	Bipolar NPN/PNP	500 ms	D10AFP
Visible Green		2 m		500 ms	D10AFPG
Visible Red		2 m		200 ms	D10AFPY
Visible Green		2 m		200 ms	D10AFPGY



Connection options: A model with a QD requires a mating cordset

For 4-pin Snap-on Pico QD cable, add suffix Q to the 2 m model number (example, D10AFPQ).

Pico QD  
(for Q7 models)  
Straight snap-on connector

Pico QD (for Q7 models)  
Right-angle snap-on connector



4-Pin  
PKG4-2  
2 m (6')

PKW4Z-2  
2 m (6')

6-Pin  
PKG6Z-2  
2 m (6')

PKW6Z-2  
2 m (6')



DIN-35..



SMBR55F01



SMBR55FRA

Additional cordset information is available  
See page 758

Additional bracket information is available  
See page 730



D10—Discrete Specifications

Required Fiber Optic Cable	Banner P-Series plastic fibers (See Plastic Fiber Optic section, page 174)
Supply Voltage & Current	10 to 30 V dc (10% max. ripple) @ less than 25 mA, exclusive of load
Supply Protection Circuitry	Protected against reverse polarity and transient voltage
Output Configuration	<b>Bipolar:</b> 1 current sourcing (PNP) and 1 current sinking (NPN)
Output Rating	100 mA per output with short circuit protection <b>OFF-state leakage current:</b> less than 10 $\mu$ A sourcing; 200 $\mu$ A sinking <b>ON-state saturation voltage:</b> NPN: 1.6 V @ 100 mA PNP: 2.0 V @ 100 mA
Output Protection Circuitry	Protected against output short-circuit and false pulse on power up
Delay at Power-up	Max. 100 milliseconds; outputs do not conduct during this time
Output Response Time	<b>Standard models (with crosstalk avoidance circuitry):</b> 500 microseconds <b>High-speed models:</b> 200 microseconds
Repeatability	<b>Standard models:</b> 95 microseconds <b>High-speed models:</b> 50 microseconds
Adjustments	12-turn Sensitivity potentiometer with relative position indicator; LO/DO Selection switch; 0 or 40 milliseconds OFF-delay switch NOTE: Use proper ESD techniques while making adjustments under cover
Indicators	<b>Two LEDs:</b> Green and Yellow <b>Green:</b> Power ON <b>Yellow:</b> Light Sensed Signal strength indicator See datasheet for detailed information
Construction	Black ABS/polycarbonate alloy (UL94 V-0 rated) housing, clear polycarbonate cover
Environmental Rating	IEC IP50; NEMA 1
Operating Conditions	<b>Temperature:</b> -10 to +55 °C <b>Storage:</b> -20 to +85 °C <b>Relative humidity:</b> 90% @ 55 °C (non-condensing)

Certifications



# Plastic Fiber Optics

Provide an economical alternative to glass fiber optics for piping photoelectric sensing light to and from confined areas with suitable environments

- Ideal for detecting small objects
- Withstand repeated flexing and bending
- Available in individual or bifurcated styles
- Available with core diameters of 0.25, 0.50, 0.75, 1.0 and 1.5 mm



## Choosing Plastic or Glass

Plastic fibers are for general purpose use. They tolerate severe flexing, can be cut to length in the field and cost less than glass fibers. Glass fibers are the best choice for challenging environments such as high temperatures, corrosive materials and moisture.



### Fiber Construction

**Core:** Thin glass or plastic center of the fiber through which light travels

**Cladding:** Outer optical material surrounding the core that reflects light back into the core

**Jacket/Sheath:** Protective layer to protect fiber from damage and moisture



### Plastic fibers page 174

- Inexpensive and easily cut to length during installation
- Bend for a precise fit
- Available in high-flex models to withstand flexing
- Offered with special jackets that withstand corrosion, impact and abrasion
- Available for applications requiring articulated or reciprocating motion
- Available in diameters of 0.25, 0.5, 1.0 Or 1.5 mm
- Can be quickly custom designed and built for your unique applications



### Glass fibers page 192

- Solve numerous challenging sensing requirements
- Ideal for hostile environments such as high temperatures to 480° C, corrosive materials and extreme moisture
- Withstand high levels of shock and vibration
- Inherently immune to extreme electrical noise
- Available with choice of sheathings: standard stainless-steel flexible conduit, PVC or other flexible tubing
- Can be quickly custom designed

## Model Key



### PLASTIC FIBER FAMILY

Same for all plastic fibers

### ASSEMBLY STYLE

- I = Individual fiber\*
- DI = Dual Individual fiber\*
- B = Bifurcated fiber

### SENSING END

- A = 90° Angle
- AT = 90° Angle/Thread
- CF = Coaxial Ferrule
- CT = Coaxial Thread
- E = Encapsulated
- EFP = Extended Ferrule Probe
- F = Ferrule
- FM = Ferrule Miniature
- FMP = Ferrule Miniature Probe
- L = Lensed
- P = Probe
- PF = Probe Ferrule
- PMSB = Probe Miniature Side-view Bendable
- PS = Probe Side-view
- PSB = Probe Side-view Bendable
- PSM = Probe Side-view Miniature
- R = Rectangular
- RS = Rectangular Side-view
- T = Thread
- TA = Thread/90° Angle
- TP = Thread/Probe

### MODIFICATIONS†

- MFR = Flex relief
- MSW = Slot width
- MTA = Tight angle
- MTL = Thread length
- MAL = Array length
- MPL = Probe length
- MFL = Ferrule length

### CONTROL END

- U = Unterminated straight cable\*\*
- UC = Unterminated Coiled cable
- UHF = Unterminated DURA-BEND™ multi-core cable
- T5 = Terminated
- TMB5 = SteelSkin™ braiding over monocoil reinforcement

### FIBER LENGTH

- 3 = 1 m (1000 mm)
- 6 = 2 m (2000 mm)
- 15 = 5 m (5000 mm)
- 30 = 9 m (9,000 mm)
- 100 = 30 m (30,000 mm)

### FIBER CORE DIAMETER

- 1 = 0.25 mm
- 2 = 0.50 mm
- 3 = 0.75 mm
- 4 = 1.00 mm
- 6 = 1.50 mm
- 1x4 = 4 x 0.25 mm
- 1x16 = 16 x 0.265 mm
- 1x32 = 32 x 0.265 mm

\* All individual plastic fiber optics are sold and used in pairs. Bifurcated fibers are two-way fibers with a single sensing end that both emits and receives light and with dual-control sensor ends that attach separately to the sensor's LED and photodetector.

\*\* Plastic fibers with "U" in the suffix of the model numbers have unterminated control ends; cut them to the required length using the supplied cutter.

† Not all modifications can be applied to all fiber assemblies. Please consult factory for verification of modifications.

## Specialty fibers for specific sensing applications

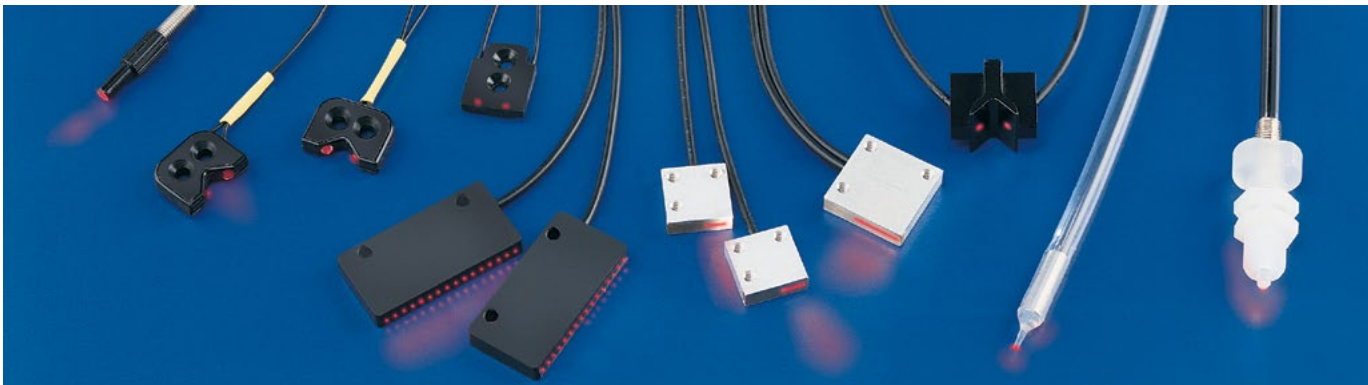

DURA-BEND™ for extremely tight radius bends



Fluoropolymer encapsulated fibers



Focused beam fibers



Convergent beam fibers



Linear array fibers



Liquid level detection fibers



High temperature fibers



SteelSkin™ for impact and abrasion





















# Vantage Line Plastic Fibers

- OEM friendly packaging
- No fiber cutter included
- Opposed models come as a pair

## Opposed Vantage Line Fibers

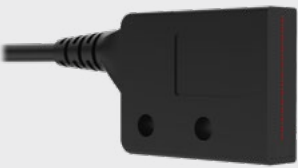

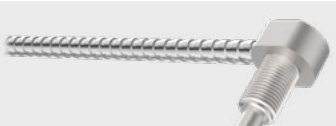
End Tip	Features	Minimum Bend Radius	Core Diameter	Free Cut	Typical Range (mm)	Models
	M6 threaded tip and integrated lens with flex relief 20 mm spot size at 100 mm	15 mm	0.5 mm		DF-G3 2000† DF-G2 2000 DF-G1 2000	PITL23UM6-VL*
	M4 threaded tip and integrated lens with flex relief 30 mm spot size at 100 mm	15 mm	0.5 mm		DF-G3 2000† DF-G2 2000 DF-G1 1680	PITL23UM4-VL*
	M4 & M2.6 threaded tip with flex relief	25 mm	1 mm		DF-G3 2000† DF-G2 1460 DF-G1 900	PIT43U-VL*
	M4 threaded tip with flex relief	25 mm	0.5 mm		DF-G3 1980 DF-G2 410 DF-G1 255	PIT23UM4-VL*
	M3 threaded tip with flex relief	25 mm	1 mm		DF-G3 2000† DF-G2 1450 DF-G1 895	PIT43UM3-VL*
	M3 threaded tip with flex relief	25 mm	0.5 mm		DF-G3 2000† DF-G2 440 DF-G1 270	PIT23U-VL*
	M4 & M2.6 threaded tip with flex relief 90° angle/thread	25 mm	1 mm		DF-G3 2000† DF-G2 1250 DF-G1 770	PIAT43UTA-VL*
	M4 & M2.6 threaded tip with flex relief 90° angle/thread	2 mm	1 mm		DF-G3 2000† DF-G2 1200 DF-G1 740	PIAT43UHFTA-VL*
	Rectangular housing with front exit 14.5 mm array	60 mm	32 x 0.25 mm	–	DF-G3 2000† DF-G2 1510 DF-G1 930	PIR1X323T-VL*
	M4 & M2.6 threaded tip with stainless protective jacket	25 mm	1 mm	–	DF-G3 2000† DF-G2 1700 DF-G1 1060	PIT43TSL5-VL*
	M4 & M2.6 threaded tip with stainless protective jacket 90° angle/thread	25 mm	1 mm	–	DF-G3 2000† DF-G2 1170 DF-G1 720	PIAT43TSL5TA-VL*

\* For two meter cable lengths replace ...3., with 6 in the model number (example, PIT46U-VL)

† Max range determined by cable length 1 m = 2,000 mm

Diffuse Vantage Line Fibers



End Tip	Features	Minimum Bend Radius	Core Diameter	Free Cut	Typical Range (mm)		Models
	M6 threaded tip with flex relief	25 mm	1 mm		DF-G3 DF-G2 DF-G1	2000 <sup>†</sup> 455 280	PBT43U-VL*
	M3 threaded tip with flex relief	25 mm	0.5 mm		DF-G3 DF-G2 DF-G1	855 180 110	PBT23U-VL*
	M4 & M2.6 thread non-bendable tip	25 mm	0.5 mm		DF-G3 DF-G2 DF-G1	815 170 105	PBT23UM4-VL*
	M6 threaded tip with flex relief 90° angle/thread	25 mm	1 mm		DF-G3 DF-G2 DF-G1	2000 <sup>†</sup> 390 240	PBAT43UTA-VL*
	M6 threaded tip with flex relief 90° angle/thread	2 mm	1 mm		DF-G3 DF-G2 DF-G1	2000 <sup>†</sup> 365 225	PBAT43UHFTA-VL*
	Rectangular housing with front exit 14.5 mm array	25 mm	32 x 0.25 mm		DF-G3 DF-G2 DF-G1	2000 <sup>†</sup> 350 215	PBR1X323U-VL*
	M6 threaded tip with stainless protective jacket	25 mm	1 mm	-	DF-G3 DF-G2 DF-G1	2000 <sup>†</sup> 500 310	PBT43TSL5-VL*
	M6 threaded tip with stainless protective jacket 90° angle/thread	25 mm	1 mm	-	DF-G3 DF-G2 DF-G1	2000 <sup>†</sup> 435 270	PBAT43TSL5TA-VL*

\* For two meter cable lengths replace ...3.. with 6 in the model number (example, PBT46U-VL)

† Max range determined by cable length 1 m = 2,000 mm (does not apply to diffuse models)



# Array and Slot Fibers



Array and Slot fibers are customizable for a simple setup and provide an optimal solution for small part counting applications. Array fibers are ideal for broad spectrum detection and slot fibers are pre-aligned and easy to install.

- Quick and easy setup and alignment
- Small part counting applications
- Multiple beams can be customized for different array lengths
- Wide area detection
- Ideal for tracking applications, profiling parts, edge guiding, finding the edge of objects
- Opposed models come as a pair

## Opposed Fibers



End Tip	Features	Minimum Bend Radius	Core Diameter	Free Cut	Typical Range (mm)	Models
	Ultra-compact head 5.25 mm straight exit Aluminium	5 mm	16 x 0.25 mm		DF-G3 4000† DF-G2 1040 DF-G1 640 D10A 260	PIR1X166U
	Ultra-compact head 5.25 mm side exit Aluminium	5 mm	16 x 0.25 mm		DF-G3 4000† DF-G2 1040 DF-G1 640 D10A 260	PIR1X166U
	Compact head 10 mm side exit Aluminium	5 mm	16 x 0.25 mm		DF-G3 4000† DF-G2 1230 DF-G1 760 D10A 260	PIR1X166UM.4
	19 mm side exit Plastic	5 mm	16 x 0.25 mm		DF-G3 4000† DF-G2 1245 DF-G1 770 D10A 270	PIR1X166UMPM.75
	34 mm side exit Plastic	5 mm	16 x 0.25 mm		DF-G3 4000† DF-G2 1100 DF-G1 680 D10A 260	PIR1X166UMPMAL
	Easy mount "fork" head Plastic	5 mm	1 mm		DF-G3 12 DF-G2 12 DF-G1 12 D10A 12	PDIS46UM12
	10 x 25 mm coverage Side (...S) or end exit (...E) Min. object detection of 1.5 mm	5 mm	16 x 0.25 mm	-	DF-G3 25 DF-G2 25 DF-G1 25 D10A 25	PFCVA-10X25-S PFCVA-10X25-E
	25 x 25 mm coverage Side (...S) or end exit (...E) Min. object detection of 3 mm	5 mm	16 x 0.25 mm	-	DF-G3 25 DF-G2 25 DF-G1 25 D10A 25	PFCVA-25X25-S PFCVA-25X25-E
	34 x 25 mm coverage Side (...S) or end exit (...E) Min. object detection of 4 mm	5 mm	16 x 0.25 mm	-	DF-G3 34 DF-G2 34 DF-G1 34 D10A 34	PFCVA-34X25-S PFCVA-34X25-E

† Max range determined by cable length 2 m = 4,000

# STEELSKIN™ Fibers

SteelSkin™ rugged fiber models resist kinking, cutting and snagging and have a low profile to easily embed in machines. Ideal for busy assembly stations, embedded in stations, part presence or places where equipment is constantly moved on and off a production line.

- Abrasion resistant while maintaining flexibility
- Bend to tighter radius and thinner than standard plastic fiber optics
- Superior resistance to wear, chemicals and other environmental conditions
- Assembly stations, part presence, busy assembly cells
- Opposed models come as a pair



## Opposed Fibers



End Tip	Features	Minimum Bend Radius	Core Diameter	Free Cut	Typical Range (mm)	Models
	Probe Stainless Steel Braid over monocoil	12 mm	1 mm	-	DF-G3 2000 <sup>†</sup> DF-G2 1200 DF-G1 740 D10A 350	PITP43TMB5
	Ferrule Stainless Steel Braid over monocoil	12 mm	1 mm	-	DF-G3 2000 <sup>†</sup> DF-G2 1200 DF-G1 740 D10A 350	PIF43TMB5
	Thread Stainless Steel Braid over monocoil	12 mm	1 mm	-	DF-G3 2000 <sup>†</sup> DF-G2 1200 DF-G1 740 D10A 350	PIT43TMB5

## Diffuse Fibers



End Tip	Features	Minimum Bend Radius	Core Diameter	Free Cut	Typical Range (mm)	Models
	Thread Stainless Steel Braid over monocoil	12 mm	1 mm	-	DF-G3 1780 DF-G2 370 DF-G1 230 D10A 80	PBT43TMB5
	Coaxial Thread Stainless Steel Braid over monocoil	12 mm	1 x 0.5 & 9 x 0.25 mm	-	DF-G3 855 DF-G2 180 DF-G1 110 D10A 40	PBCT23TMB5
	Coaxial Threaded right angle Stainless Steel Braid over monocoil	12 mm	1 x 0.5 & 9 x 0.25 mm	-	DF-G3 620 DF-G2 130 DF-G1 80 D10A 30	PBCT23TMB5MTA
	Coaxial Thread Stainless Steel Braid over monocoil	12 mm	1 x 0.5 & 9 x 0.25 mm	-	DF-G3 855 DF-G2 180 DF-G1 110 D10A 40	PBCT23TMB5M4
	Threaded right angle Stainless Steel Braid over monocoil	12 mm	1 mm	-	DF-G3 1630 DF-G2 340 DF-G1 210 D10A 80	PBAT43TMB5MTA

<sup>†</sup> Max range determined by cable length 1 m = 2,000 (does not apply to diffuse models)

# DURA-BEND™ Fibers

DURA-BEND™ fiber models provide improved flexibility for limited space setups and difficult-to-access locations. These fibers are best for use when fibers need to be integrated into a small fixture where a great deal of bending in tight spaces is needed.

- Minimal transmission loss under extreme bend radius
- Maintains performance regardless of flexing
- Multicore assemblies available
- Can almost kink fiber without affecting performance
- Works well in constant flexing applications
- Opposed models come as a pair



## Opposed Fibers



End Tip	Features	Minimum Bend Radius	Core Diameter	Free Cut	Typical Range (mm)	Models
	M4 x 0.7 and M2.5 x 0.45 Thread	2 mm	1 mm		DF-G3 3420 DF-G2 715 DF-G1 440 D10A 230	PIT46UHF
	Smooth ferrule	2 mm	1 mm		DF-G3 3420 DF-G2 715 DF-G1 440 D10A 230	PIF46UHF
	Thread	1 mm	0.5 mm		DF-G3 930 DF-G2 195 DF-G1 120 D10A 65	PIT26UHF
	Smooth ferrule	2 mm	1 mm		DF-G3 3420 DF-G2 710 DF-G1 440 D10A 230	PIFM46UHF
	Right angle Low profile	2 mm	1 mm		DF-G3 3110 DF-G2 650 DF-G1 400 D10A 200	PIA46UHFMBMPMS
	Right angle Threaded	2 mm	1 mm		DF-G3 3420 DF-G2 710 DF-G1 440 D10A 330	PIAT46UHFMTA

## Diffuse Fibers



End Tip	Features	Minimum Bend Radius	Core Diameter	Free Cut	Typical Range (mm)	Models
	Thread	1 mm	0.5 mm		DF-G3 310 DF-G2 65 DF-G1 40 D10A 18	PBT26UHF
	Thread	2 mm	1 mm		DF-G3 1090 DF-G2 230 DF-G1 140 D10A 70	PBT46UHF
	Right Angle Threaded	2 mm	1 mm		DF-G3 930 DF-G2 195 DF-G1 120 D10A 70	PBAT46UHFMTA



# High Temp Fibers

High temp fiber optics are used in situations where the temperature is above a certain limit for most plastic fibers. These are usually used in thermal process applications and Banner offers the widest selection of plastic and glass fibers for high temperature situations.

- For high temp applications above 100° C
- Thermal process applications
- For sensing near manufacturing ovens
- Manufacturing of solar panels, colored glass and ceramics
- Widest selection of plastic and glass fibers for high temp applications

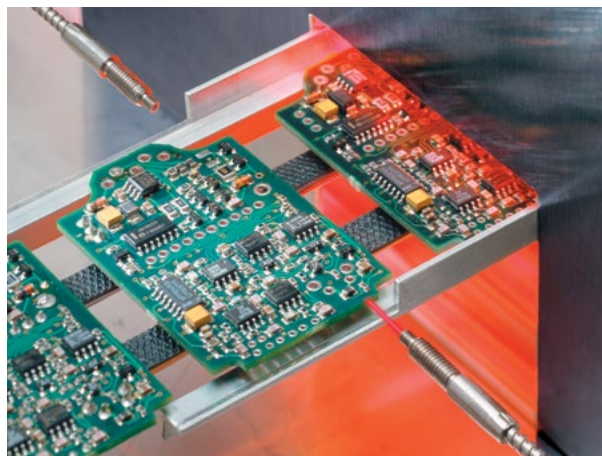

## Opposed Fibers



End Tip	Features	Minimum Bend Radius	Core Diameter	Free Cut	Typical Range (mm)	Models
	M2.5 x 0.45 thread Stainless Steel Sheath End tip withstands 315° C	19 mm	1.2 mm	–	DF-G3 4000 <sup>†</sup> DF-G2 1260 DF-G1 775 D10A 325	IMT.756.6S-HT
	Smooth ferrule Side exit Stainless steel 250° C	19 mm	0.5 mm	–	DF-G3 1320 DF-G2 275 DF-G1 170 D10A 53	IA.31.7ST5ETA
	Smooth ferrule 90° angle Stainless steel tip End tip withstands 105° C	19 mm	1.3 mm	–	DF-G3 4000 <sup>†</sup> DF-G2 1310 DF-G1 810 D10A 310	IA.82.5PT5
	Smooth ferrule Side exit Stainless steel 480° C	19 mm	1.3 mm	–	DF-G3 4000 <sup>†</sup> DF-G2 1310 DF-G1 810 D10A 300	IA.83.3ST5ETA
	Thread End tip withstands 105° C	15 mm	1 mm		DF-G3 4000 <sup>†</sup> DF-G2 960 DF-G1 600 D10A 210	PIT46UHT1

<sup>†</sup> Max range determined by cable length 2 m = 4,000

## Diffuse Fibers



End Tip	Features	Minimum Bend Radius	Core Diameter	Free Cut	Typical Range (mm)	Models
	Miniature thread Stainless Steel Sheathing End tip withstands 315° C	19 mm	1.6 mm	–	DF-G3 390 DF-G2 80 DF-G1 50 D10A 15	BMT16.6S-HT
	Thread right angle Stainless Steel Sheathing End tip withstands 250° C	12 mm	1.6 mm	–	DF-G3 2100 DF-G2 440 DF-G1 270 D10A NA	BAT16.6ST5MTA
	Thread End tip withstands 105° C	15 mm	0.5 mm		DF-G3 390 DF-G2 80 DF-G1 50 D10A 20	PBT26UHT2

# Specialty Fibers

Specialty and custom fibers are designed for specific sensing applications. Many of the standard fibers can be customized and ready for use in days, not weeks. Banner excels in customization and will work with you to find the right solution.

- Chemical resistance
- Extreme environments
- Liquid level detection
- Customize bifurcations, material, lengths and other fiber features

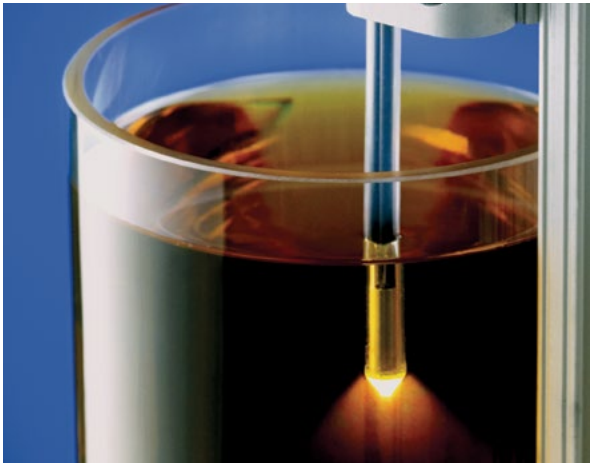

## Liquid Level Fibers

End Tip	Features	Minimum Bend Radius	Core Diameter	Free Cut	Typical Range (mm)	Models
	Fluoropolymer encapsulated Sensor switches when tip of fiber is immersed in liquid	25 mm	1 mm		DF-G3 DF-G2 DF-G1 D10A	NA       <b>PBE46UTMLLP</b>
	Fluoropolymer encapsulated Sensor switches when tip of fiber is immersed in liquid End tip withstands 105° C	15 mm	1 mm		DF-G3 DF-G2 DF-G1 D10A	NA       <b>PBE46UTMLLPHT1</b>
	Clear tube mount, 2 to 25 mm diameter	2 mm	1 mm		Sensor switches when liquid meniscus reaches optical axis	<b>PDI46U-LLD</b>

## Diffuse Fibers



End Tip	Features	Minimum Bend Radius	Core Diameter	Free Cut	Typical Range (mm)	Models
	Coaxial ferrule probe Non-metallic end tip	25 mm	1 x 1.0 & 16 x 0.25 mm		DF-G3 1710 DF-G2 360 DF-G1 220 D10A 120	<b>PBCFP46UMLR</b>
	Fluoropolymer encapsulated tip	25 mm	1 mm		DF-G3 1710 DF-G2 360 DF-G1 220 D10A 12	<b>PBE46UTMNL</b>
	Dual bifurcated Light "OR" or Dark "AND" logic	15 mm	0.5 mm	-	DF-G3 DF-G2 DF-G1 D10A	NA       <b>PDBF26T5</b>



Opposed Fibers



End Tip	Features	Minimum Bend Radius	Core Diameter	Free Cut	Typical Range (mm)	Models
	Specialty slot sensor 90° angle; compact "fork" head	2 mm	1 mm		DF-G3 5 DF-G2 5 DF-G1 5 D10A 5	PDISM46UM5MA
	Sold as a pair Fluoropolymer encapsulated; lens	25 mm	1 mm		DF-G3 4000† DF-G2 3080 DF-G1 1900 D10A 1600	PIE46UT
	Sold as a pair Fluoropolymer encapsulated; lens	40 mm	1.5 mm		DF-G3 4000† DF-G2 1540 DF-G1 950 D10A 300	PIE66UTMNL
	Sold as a pair Fluoropolymer encapsulated; Side-view prism	25 mm	1 mm		DF-G3 400 DF-G2 280 DF-G1 280 D10A 280	PIES46UT
	Sold as a pair Flat sides for easy alignment Brass housing	40 mm	1.5 mm		DF-G3 4000† DF-G2 1100 DF-G1 680 D10A 350	PIPS66UMSQMAP

Vacuum Applications

End Tip	Features	Minimum Bend Radius	Core Diameter	Free Cut	Typical Range (mm)	Models
	Vacuum compatible No epoxy	19 mm	1.6 mm	-	Varies by feed through and amp used	BMT13SMVF
	Aluminum Vacuum feed through	-	-	-	DF-G3 NA DF-G2 NA DF-G1 NA D10A NA	DVFT-2.ONWQ50
	Miniature thread No epoxy used For use on vacuum side Entire cable withstands 480 °C	19 mm	1.2 mm	-	Varies by feed through and amp used	IMT.753SMVF
	For use with Vacuum feed through on ambient side Opposed mode sold as a pair	40 mm	1.5 mm		DF-G3 4000† DF-G2 2140 DF-G1 1320 D10A 350	PIF66UMVFA
	Stainless steel Vacuum feed through	-	-	-	DF-G3 NA DF-G2 NA DF-G1 NA D10A NA	VFT-M8MVS

† Max range determined by cable length 2 m = 4,000

# Standard Fibers

Standard fiber optics come in a variety of materials with standard fiber tips in various sizes. If a standard fiber does not meet your application requirements, modifications can be made to give you a customized solution.

- Plastic individual fibers ideal for use in small, confined areas
- Available in side view/right angles
- Available in bifurcated models
- Opposed models come as a pair



## Opposed Fibers



End Tip	Features	Minimum Bend Radius	Core Diameter	Free Cut	Typical Range (mm)	Models
	Smooth ferrule Stainless steel tip	15 mm	0.5 mm		DF-G3 1710 DF-G2 355 DF-G1 220 D10A 75	PIF26U
	Smooth ferrule Stainless steel tip	25 mm	1 mm		DF-G3 4000† DF-G2 1330 DF-G1 820 D10A 300	PIF46U
	Smooth ferrule Stainless steel tip	40 mm	1.5 mm		DF-G3 4000† DF-G2 2140 DF-G1 1320 D10A 525	PIF66U
	Stainless steel tip Best for repetitive flexing (1,000s of cycles)	5 mm	4 x 0.25 mm		DF-G3 1940 DF-G2 405 DF-G1 250 D10A 70	PIFM1X46U
	Smooth ferrule Stainless steel tip	25 mm	1 mm		DF-G3 4000† DF-G2 1330 DF-G1 820 D10A 300	PIFM46U
	Smooth ferrule Stainless steel tip	5 mm	0.25 mm		DF-G3 505 DF-G2 105 DF-G1 65 D10A 20	PIF16U
	Smooth ferrule Stainless steel tip Thick jacket (ø 2.2 mm)	15 mm	0.5 mm		DF-G3 1710 DF-G2 355 DF-G1 220 D10A 80	PIF26UMLS
	Smooth ferrule Stainless steel tip 90° angle sideview	25 mm	1 mm		DF-G3 2720 DF-G2 565 DF-G1 350 D10A 160	PIPS46U
	Smooth ferrule Stainless steel tip 90° angle sideview	40 mm	1.5 mm		DF-G3 2950 DF-G2 615 DF-G1 380 D10A 350	PIPS66U
	Probe Stainless steel tip	5 mm	0.5 mm		DF-G3 505 DF-G2 105 DF-G1 65 D10A 20	PIP16U

† Max range determined by cable length 2 m = 4,000

Opposed Fibers



End Tip	Features	Minimum Bend Radius	Core Diameter	Free Cut	Typical Range (mm)	Models
	Probe Stainless steel tip	15 mm	0.5 mm		DF-G3 1825 DF-G2 380 DF-G1 235 D10A 80	PIP26U
	Probe Stainless steel tip	25 mm	1 mm		DF-G3 4000 <sup>†</sup> DF-G2 1230 DF-G1 760 D10A 265	PIP46U
	Stainless steel threaded tip	5 mm	0.25 mm		DF-G3 465 DF-G2 100 DF-G1 60 D10A 15	PIT16U
	Nickel plated brass threaded tip	15 mm	0.5 mm		DF-G3 1710 DF-G2 220 DF-G1 75 D10A	PIT26U
	Nickel plated brass threaded tip	25 mm	1 mm		DF-G3 4000 <sup>†</sup> DF-G2 1120 DF-G1 690 D10A 240	PIT415U
	Nickel plated brass threaded tip	25 mm	1 mm		DF-G3 4000 <sup>†</sup> DF-G2 1330 DF-G1 820 D10A 300	PIT46U
	Nickel plated brass threaded tip	40 mm	1.5 mm		DF-G3 4000 <sup>†</sup> DF-G2 2140 DF-G1 1320 D10A 525	PIT66U
	Nickel plated brass threaded tip	40 mm	1.5 mm		DF-G3 4000 DF-G2 1815 DF-G1 1120 D10A 450	PIT615U
	Stainless steel 90° angle tip	5 mm	0.25 mm		DF-G3 230 DF-G2 50 DF-G1 30 D10A 15	PIA16U
	Stainless steel 90° angle tip	15 mm	0.5 mm		DF-G3 930 DF-G2 195 DF-G1 120 D10A 50	PIA26U
	Nickel plated brass threaded 90° angle tip	5 mm	0.25 mm		DF-G3 465 DF-G2 100 DF-G1 60 D10A 10	PIAT16U
	Nickel plated brass threaded 90° angle tip	15 mm	0.5 mm		DF-G3 1555 DF-G2 325 DF-G1 200 D10A 50	PIAT26U

<sup>†</sup> Max range determined by cable length 2 m = 4,000

Opposed Fibers



End Tip	Features	Minimum Bend Radius	Core Diameter	Free Cut	Typical Range (mm)	Models
	Stainless steel threaded 90° angle tip	25 mm	1 mm		DF-G3 4000† DF-G2 1360 DF-G1 840 D10A 275	PIAT46U
	Stainless steel threaded 90° angle tip	40 mm	1.5 mm		DF-G3 4000† DF-G2 2075 DF-G1 1280 D10A 350	PIAT66U
	Stainless steel threaded 90° angle tip	25 mm	1 mm		DF-G3 4000† DF-G2 1360 DF-G1 840 D10A 275	PIAT46UM.4X.4MT
	Stainless steel threaded 90° angle tip	2 mm	1 mm		DF-G3 4000† DF-G2 970 DF-G1 600 D10A 210	PIAT46UHF
	Delrin side exit	2 mm	1 mm		DF-G3 2000† DF-G2 710 DF-G1 440 D10A 230	PIA46UHFMB8X12

† Max range determined by cable length 2 m = 4,000

Diffuse Fibers



End Tip	Features	Minimum Bend Radius	Core Diameter	Free Cut	Typical Range (mm)	Models
	Smooth ferrule Stainless steel tip	15 mm	0.5 mm		DF-G3 620 DF-G2 130 DF-G1 80 D10A 25	PBF26U
	Smooth ferrule Stainless steel tip	25 mm	1 mm		DF-G3 1710 DF-G2 355 DF-G1 220 D10A 85	PBF46U
	Smooth ferrule Stainless steel tip Thin jacket (ø 1.3)	25 mm	1 mm		DF-G3 1710 DF-G2 355 DF-G1 220 D10A 85	PBF46UM3MJ1.3
	Smooth ferrule Stainless steel tip	40 mm	1.5 mm		DF-G3 2410 DF-G2 500 DF-G1 310 D10A 170	PBF66U
	Smooth ferrule Stainless steel tip	2 mm	1 mm		DF-G3 1445 DF-G2 300 DF-G1 186 D10A 65	PBF46UHF
	Smooth ferrule Stainless steel tip Coaxial	5 mm	1 x 1.0 and 16 x 0.25 mm		DF-G3 2140 DF-G2 445 DF-G1 275 D10A 96	PBCF46U
	Smooth ferrule Stainless steel tip	15 mm	0.5 mm		DF-G3 175 DF-G2 160 DF-G1 100 D10A 35	PBEFP26U
	Smooth ferrule Stainless steel tip	25 mm	1 mm		DF-G3 1980 DF-G2 410 DF-G1 255 D10A 90	PBFM46U
	Smooth ferrule Stainless steel tip	2 mm	1 mm		DF-G3 1440 DF-G2 300 DF-G1 185 D10A 65	PBFM46UHF
	Smooth ferrule Stainless steel tip	5 mm	0.25 mm		DF-G3 4000† DF-G2 1120 DF-G1 690 D10A 240	PBFMP16UMP.2
	Smooth ferrule Stainless steel tip 90° angle sideview	15 mm	0.5 mm		DF-G3 230 DF-G2 50 DF-G1 30 D10A 15	PBPS26U
	Smooth ferrule Stainless steel tip 90° angle sideview	25 mm	1 mm		DF-G3 275 DF-G2 160 DF-G1 100 D10A 50	PBPS46U
	Probe ferrule Stainless steel tip	15 mm	0.5 mm		DF-G3 545 DF-G2 115 DF-G1 70 D10A 30	PBPF215U
	Probe ferrule Bendable stainless steel tip	15 mm	0.5 mm		DF-G3 620 DF-G2 130 DF-G1 80 D10A 25	PBP26U

Diffuse Fibers



End Tip	Features	Minimum Bend Radius	Core Diameter	Free Cut	Typical Range (mm)	Models
	Probe ferrule Bendable stainless steel tip	25 mm	1 mm	✂	DF-G3 1710 DF-G2 355 DF-G1 220 D10A 85	PBP46U
	Probe ferrule Stainless steel tip	5 mm	0.25 mm	✂	DF-G3 155 DF-G2 30 DF-G1 20 D10A 10	PBFM16U
	Probe ferrule Bendable stainless steel tip	5 mm	0.25 mm	✂	DF-G3 115 DF-G2 25 DF-G1 15 D10A 5	PBP16U
	Probe ferrule Bendable stainless steel tip	2 mm	1 mm	✂	DF-G3 1475 DF-G2 310 DF-G1 190 D10A 65	PBP46UHF
	Probe ferrule Stainless steel tip	15 mm	0.5 mmv	✂	DF-G3 620 DF-G2 130 DF-G1 80 D10A 25	PBPF26U
	Coaxial Threaded Stainless steel tip	5 mm	1 x 0.5 & 9 x 0.25 mm	✂	DF-G3 700 DF-G2 145 DF-G1 90 D10A 40	PBCT26U
	Coaxial Threaded Stainless steel tip	5 mm	1 x 0.5 & 9 x 0.25 mm	✂	DF-G3 700 DF-G2 145 DF-G1 90 D10A 40	PBCT26UM3
	Coaxial Threaded Stainless steel tip	5 mm	1 x 0.5 & 9 x 0.25 mm	✂	DF-G3 700 DF-G2 145 DF-G1 90 D10A 40	PBCT26UM4M2.5
	Coaxial Threaded Stainless steel tip Overmolded flex relief	15 mm	1 x 0.5 10 x 0.25 mm	✂	DF-G3 1555 DF-G2 325 DF-G1 200 D10A 110	PBCT26UMFR
	Coaxial Threaded Nickel plated Brass tip	5 mm	1 x 1.0 & 16 x 0.25 mm	✂	DF-G3 1710 DF-G2 355 DF-G1 220 D10A 120	PBCT46U
	Coaxial Threaded Stainless steel tip Overmolded flex relief	25 mm	1 x 1.0 16 x 0.25 mm	✂	DF-G3 1555 DF-G2 325 DF-G1 200 D10A 110	PBCT46UMFR
	Threaded Stainless steel tip	5 mm	0.25 mm	✂	DF-G3 80 DF-G2 15 DF-G1 10 D10A 5	PBT16U
	Threaded Nickel plated Brass tip	15 mm	0.5 mm	✂	DF-G3 620 DF-G2 130 DF-G1 80 D10A 25	PBT26U
	Stainless steel tip	12 mm	0.5 mm	✂	DF-G3 620 DF-G2 130 DF-G1 80 D10A 25	PBT26UMSSMFF

Diffuse Fibers



End Tip	Features	Minimum Bend Radius	Core Diameter	Free Cut	Typical Range (mm)	Models
	Threaded Nickel plated Brass tip	25 mm	1 mm		DF-G3 1710 DF-G2 355 DF-G1 220 D10A 85	PBT46U
	Threaded Nickel plated Brass tip	40 mm	1.5 mm		DF-G3 2400 DF-G2 500 DF-G1 310 D10A 170	PBT66U
	Threaded Nickel plated Brass tip	25 mm	1 mm		DF-G3 1400 DF-G2 290 DF-G1 180 D10A 70	PBT415U
	Threaded Nickel plated Brass tip	15 mm	0.5 mm		DF-G3 740 DF-G2 155 DF-G1 95 D10A 30	PBT26UM6M.1
	Stainless steel threaded 90° angle tip	25 mm	1 mm		DF-G3 930 DF-G2 195 DF-G1 120 D10A 70	PBAT46U
	10.9 mm front exit Aluminium	5 mm	32 x 0.25 mm		DF-G3 1555 DF-G2 325 DF-G1 200 D10A 65	PBR1X326U
	10.9 mm side exit Aluminium	5 mm	32 x 0.25 mm		DF-G3 1555 DF-G2 325 DF-G1 200 D10A 65	PBR1X326U
	Dual lens straight exit Aluminium	25 mm	1 mm		DF-G3 4000† DF-G2 950 DF-G1 590 D10A 210	PBL46U

† Max range determined by cable length 2 m = 4,000



Plastic Fiber Optics Specifications

Construction	<p><b>Optical Fiber:</b> Acrylic (PMMA) monofilament, except as noted  <b>Protective Jacket:</b> Black polyethylene, except as noted  <b>Threaded End Tips and Hardware:</b> Nickel-plated brass, except as noted  <b>Probe End Tips:</b> Annealed (bendable) 304 stainless steel  <b>Angled End Tips:</b> Hardened 304 stainless steel  <b>Ferrule End Tips:</b> 303 stainless steel</p>
Sensing Range	Refer to the specific fiber optic/sensor combination
Implied Dimensional Tolerance	All dimensions are in millimeters: x = ±2.5 mm, x.x = ±0.25 mm and x.xx = ±0.12 mm, unless specified "L" = ±40 mm per meter
Minimum Bend Radius	8 mm for 0.25 mm diameter fibers 12 mm for 0.5 mm diameter fibers (except DURA-BEND™) 25 mm for 1.0 mm diameter fibers (except DURA-BEND™) 38 mm for 1.5 mm diameter fibers
Repeat Bending/Flexing	Life expectancy of plastic fiber optic cable is in excess of one million cycles at bend radii of no less than the minimum and a bend of 90° or less. Avoid stress at the point where the cable enters the sensor ("control end") and at the sensing end tip. Coiled plastic fiber optic assemblies are recommended for any application requiring reciprocating fiber motion.
Chemical Resistance	The acrylic core of the monofilament optical fiber will be damaged by contact with acids, strong bases (alkalis) and solvents. The polyethylene jacket will protect the fiber from most chemical environments. However, materials may migrate through the jacket with long term exposure. Samples of fiber optic material are available from Banner for testing and evaluation.
Temperature Extremes	Temperatures below -30 °C will cause embrittlement of the plastic materials but will not cause transmission loss. Temperatures above +70 °C will cause both transmission loss and fiber shrinkage.
Operating Temperature	-30 to +70 °C, unless otherwise specified

Fiber Core Diameter Comparison

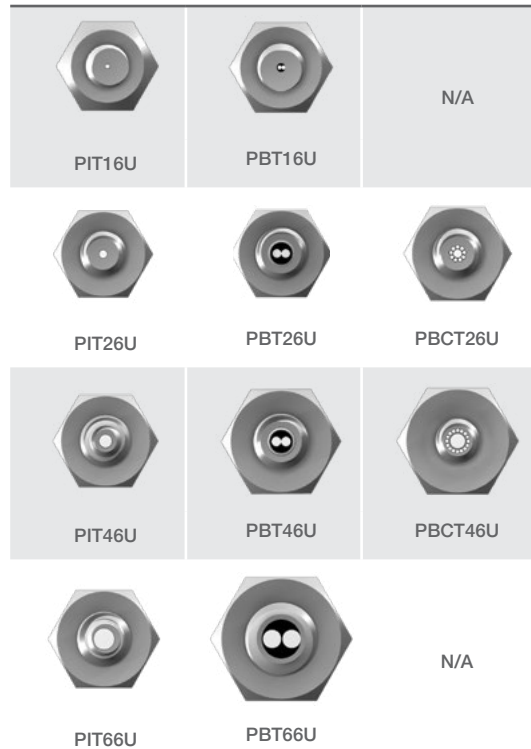

**⚠ Application Notes and Warnings ⚠**

- 1 Plastic fiber assemblies with "U" in the suffix of the model numbers have unterminated control ends (the end that is coupled to the photoelectric sensor). The customer can cut these fiber optic assemblies to the required length using the supplied cutter. Use only the supplied cutter to ensure optimal light coupling efficiency.
- 2 Terminated plastic fiber assemblies are optically ground and polished and cannot be shortened, spliced or otherwise modified.
- 3 Do not subject the plastic fibers to sharp bends, pinching, high tensile loads or high levels of radiation.
- 4 When ordering fiber lengths in excess of 2 m, take into account light signal attenuation due to the additional length.
- 5 Due to their light transmission properties, plastic fiber optics are recommended for use only with visible light fiber optic sensors.
- 6 Use caution when applying fiber optics in hazardous locations. Although fiber optic assemblies are, by themselves, intrinsically safe, the sensor and associated electronics must be LOCATED IN A SAFE ENVIRONMENT. Alternatively, fiber optics may be used with NAMUR sensor model Q45AD9FP. Fiber optics do not necessarily provide a hermetic seal between a hazardous environment and the safe environment.

Fiber Optic Accessories

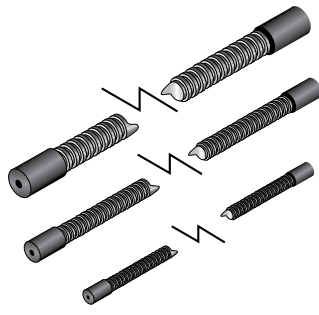
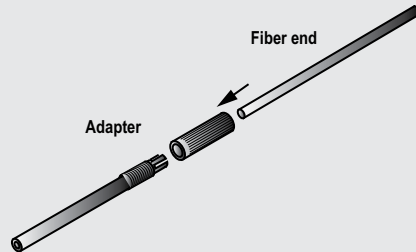
	Model Specific Features	General Features	Image	Model Number
Fiber Cutters	Plastic fiber cutter	single cutter	 <p>NOTE: Adaptors used with Q45, OMNI-BEAM, ECONO-BEAM, MAXI-BEAM and VALU-BEAM sensors only.</p>	PFC-4
		100 cutters		PFC-4-100
	For use with 0.25 and 0.5 mm diameter cables.	<ul style="list-style-type: none"> <li>• These kits are used with unterminated plastic fiber cables</li> <li>• Each kit contains 40 sensor adaptors and 10 cutter assemblies</li> </ul>		PFK20
	For use with 1 and 1.5 mm diameter cables.			PFK40
Plastic Fiber Field-Installable Sheathing	May be used with bifurcated fiber assemblies having M6 x 0.75 threaded end tips (e.g., PBCT46U, PBP46U, PBT46UHT1 and PBT66U).	<ul style="list-style-type: none"> <li>• Stainless steel sheathing with stainless steel end fittings (one end internally threaded to capture fiber end tips, other end non-threaded) is used in applications where protection is required for plastic fiber optic cables</li> <li>• All models listed are 1.8 m in length</li> <li>• Other lengths are available by contacting Banner Applications Department</li> </ul>		PFS69S6T
	May be used with individual or bifurcated fiber assemblies having M4 x 0.7 threaded end tips (e.g., PBCT26U, PBP26U, PIP46U, PIT46U and PIT66U).			PFS53S6T
	May be used with individual fiber assemblies having M3 x 0.5 threaded end tips (e.g., PIP26U, PIT26U and PIT1X46U).			PFS44S6T
Plastic Fiber Adapters	Use to adapt plastic fiber optic cables with outside jacket diameter of 1.0 mm, such as PIT26U and PBP16U.	<ul style="list-style-type: none"> <li>• Compression fitting adapters are used with small-diameter unterminated plastic fiber cables</li> <li>• Use when interfacing small-diameter plastic fibers to D10, D12, QM42, QS18, R55F, FI22 and MINI-BEAM plastic fiber sensor families</li> <li>• Each kit contains 100 pairs of adapters. One pair will interface either one bifurcated fiber optic cable or a pair of individual cables to a fiber optic amplifier</li> </ul>		UPFA-1-100
	Use to adapt plastic fiber optic cables with outside jacket diameter of 1.25 mm or 1.3 mm, such as PBCT26U and PBF46UM3MJ1.3.			UPFA-2-100

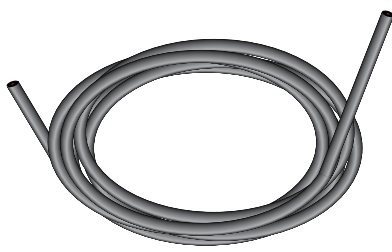
	Core	Length	Type	Drawing	Model Number
Unterminated Individual and Bifurcated Plastic Fibers	0.5 mm	9 m	Single		PIU230U
		18 m			PIU260U
	1.0 mm	9 m	Single		PIU430U
		18 m			PIU460U
	1.5 mm	9 m	Single		PIU630U
		18 m			PIU660U
	1.0 mm	9 m	Duplex		PBU430U
		18 m			PBU460U

# Glass Fiber Optics

Solve numerous challenging sensing applications in the most hostile environments, including temperatures up to 480° C, corrosive materials and extreme moisture

- Withstand severe shock and vibration
- Ignore extreme electrical noise
- Constructed of a combination of optical glass fiber, stainless steel, PVC, brass, molded thermoplastics and optical-grade epoxy

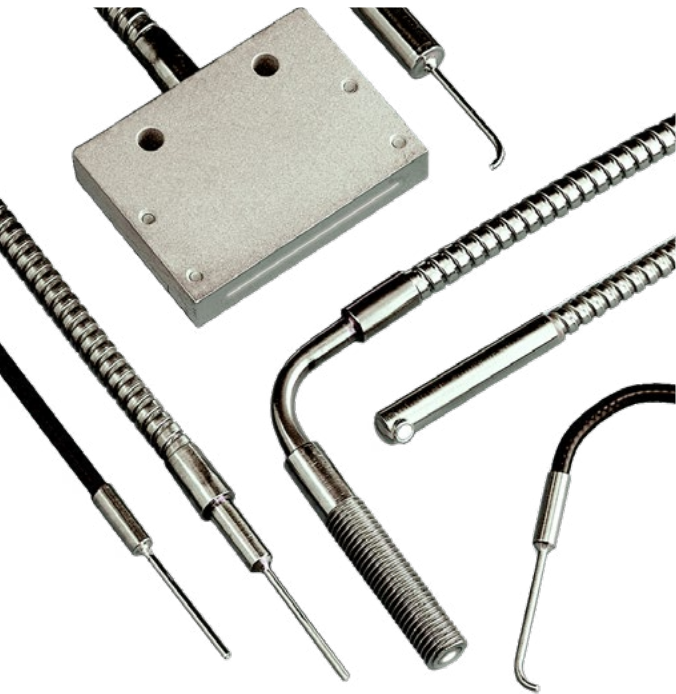

## Choosing Glass or Plastic

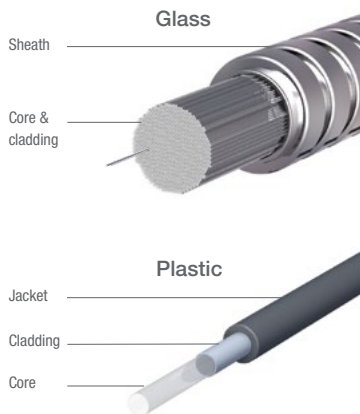

### Fiber Construction

**Core:** Thin glass or plastic center of the fiber through which light travels

**Cladding:** Outer optical material surrounding the core that reflects light back into the core

**Jacket/**

**Sheath:** Protective layer to protect fiber from damage and moisture

Plastic fibers are for general purpose use. They tolerate severe flexing, can be cut to length in the field and cost less than glass fibers. Glass fibers are the best choice for challenging environments such as high temperatures, corrosive materials and moisture.



### Glass fibers **page 192**

- Solve numerous challenging sensing requirements
- Ideal for hostile environments such as high temperatures to 480° C, corrosive materials and extreme moisture
- Withstand high levels of shock and vibration
- Inherently immune to extreme electrical noise
- Available with choice of sheathings: standard stainless-steel flexible conduit, PVC or other flexible tubing
- Can be quickly custom designed



### Plastic fibers **page 174**

- Inexpensive and easily cut to length during installation
- Bend for a precise fit
- Available in high-flex models to withstand flexing
- Offered with special jackets that withstand corrosion, impact and abrasion
- Available for applications requiring articulated or reciprocating motion
- Available in diameters of 0.25, 0.5, 1.0 Or 1.5 mm
- Can be quickly custom designed and built for your unique applications

## Model Key



### ASSEMBLY STYLE

- B = Bifurcated fiber
- I = Individual fiber\*

### SENSING END TIP STYLE

- A = 90° Angle
- AM = Miniature 90° Angle
- AT = 90° Angle/Thread
- F = Ferrule
- M = Miniature Tip
- MP = Miniature Probe
- MT = Miniature Thread
- R = Rectangular Bundle Termination
- T = Thread
- TA = Thread/90° Angle
- TETA = Thread and Extra Tight 90° Angle

### MODIFICATIONS

- "MXX" = Sensing end tip modification
- "M600" = Sensing end withstands 315° C
- "M900" = Sensing end withstands 480° C

### SHEATHING MATERIAL

- S = Stainless steel flexible conduit
- P = PVC with galvanized monocoil reinforcing wire

### OVERALL LENGTH (in feet)

- 2 = 2 ft. = 610 mm ±38 mm
- 3 = 3 ft. = 914 mm ±38 mm

### FIBER BUNDLE DIAMETER

- .44 = 0.027 in = 0.69 mm
- .5 = 0.032 in = 0.81 mm
- .75 = 0.046 in = 1.17 mm
- 1 = 0.062 in = 1.57 mm
- 1.5 = 0.09 in = 2.29 mm
- 2 = 0.125 in = 3.18 mm
- 2.5 = 0.156 in = 3.96 mm

\* Individual glass fibers are packaged separately.

Opposed Glass Fibers



End Tip	Features	Minimum Bend Radius	Core Diameter	Temp	Typical Range (mm)		Models
	90° angle	19 mm	3.18 mm	<b>M600</b> <b>M900</b>	QS18 R55F SME312 D12E D12	715 1050 250 975 550	IA23S
	90° angle/thread Lenses available	19 mm	3.18 mm	<b>M600</b> <b>M900</b>	QS18 R55F SME312 D12E D12	900 1050 250 975 550	IAT23S
	Smooth ferrule	19 mm	3.18 mm	<b>M600</b> <b>M900</b>	QS18 R55F SME312 D12E D12	990 1050 975 550	IF23P
	Miniature thread	9.5 mm	0.69 mm		QS18 R55F SME312 D12E D12	NA 75 25 102 70	IMT.442P
	Thread Lenses available	19 mm	3.18 mm	<b>M600</b> <b>M900</b>	QS18 R55F SME312 D12E D12	900 1050 250 975 550	IT23S
	90° angle/thread	19 mm	3.18 mm	<b>M600</b> <b>M900</b>	QS18 R55F SME312 D12E D12	1100 1050 250 925 550	ITA23S
	Miniature probe 90° angle	19 mm	1.17 mm	<b>M600</b>	QS18 R55F SME312 D12E D12	110 130 50 180 170	IAM.752S
	Miniature probe Non-bendable probe	19 mm	1.17 mm	<b>M600</b>	QS18 R55F SME312 D12E D12	NA 130 50 180 170	IM.752S
	Miniature probe	9.5 mm	1.17 mm		QS18 R55F SME312 D12E D12	NA 130 50 180 170	IMP.753P

**M600** Available 315 °C models. Add M600 to end of model number (example, IA23SM600).

**M900** Available 480 °C models. Add M900 to end of model number (example, IA23SM900).  
Dimensions may vary for these models.

NA: Not recommended.

Opposed Glass Fibers



End Tip	Features	Minimum Bend Radius	Core Diameter	Temp	Typical Range (mm)	Models
	Straight exit; 38 mm width	19 mm	3.7 mm	M600	QS18 760 R55F 1175 SME312 350 D12E 975 D12 580	IR2.53S
	Straight exit; 10 mm width	19 mm	3.2 mm	M600	QS18 1045 R55F 1050 SME312 250 D12E 925 D12 550	IR23S
	Side exit Stainless steel	19 mm	2.3 mm	M600	QS18 250 R55F 600 SME312 180 D12E 500 D12 450	IA1.53SMETA
	Side exit Stainless steel	19 mm	2.3 mm	M600	QS18 340 R55F 600 SME312 180 D12E 500 D12 450	IA1.53SMTA
	Side exit Stainless steel	19 mm	2.3 mm	M600	QS18 390 R55F 600 SME312 180 D12E 500 D12 450	ITETA1.53S
	For use in vacuum applications No epoxy	19 mm	1.3 mm		Contact factory for sensing range	IMT.753SMVF
	Glass lens withstands 315 °C Contact factory for range					L9
	Plastic housing withstands 105 °C Contact factory for range					L16F
	Aluminum housing withstands 315 °C Contact factory for range					L16FAL
	Stainless steel housing withstands 480 °C Contact factory for range					L16FSS

M600 Available 315 °C models. Add M600 to end of model number (example, BA23SM600).

Diffuse Glass Fibers

End Tip	Features	Minimum Bend Radius	Core Diameter	Temp	Typical Range (mm)		Models
	Stainless steel 90° angle	19 mm	3.2 mm	<b>M600</b> <b>M900</b>	QS18 R55F SME312 D12E D12	80 110 25 180 150	BA23S
	Stainless Steel/Brass 90° angle	19 mm	3.2 mm	<b>M600</b> <b>M900</b>	QS18 R55F SME312 D12E D12	90 110 25 180 150	BAT23S
	PVC sheath	19 mm	3.2 mm	-	QS18 R55F SME312 D12E D12	100 110 25 180 150	BF23P
	PVC over Moncoil Sheathing Brass	9.5 mm	0.7 mm	-	QS18 R55F SME312 D12E D12	NA NA 1 10 5	BMT.442P
	Stainless Steel/Brass	19 mm	3.2 mm	<b>M600</b> <b>M900</b>	QS18 R55F SME312 D12E D12	100 110 25 180 150	BT23S
	Stainless steel/Brass 90° angle	19 mm	3.2 mm	<b>M600</b> <b>M900</b>	QS18 R55F SME312 D12E D12	85 110 25 180 150	BTA23S
	Stainless Steel 90° angle	19 mm	1.2 mm	<b>M600</b>	QS18 R55F SME312 D12E D12	NA 11 3 42 25	BAM.752S
	Stainless Steel Probe	19 mm	1.2 mm	<b>M600</b>	QS18 R55F SME312 D12E D12	NA 11 3 42 25	BM.752S
	PVC over Moncoil Sheathing Probe	9.5 mm	1.2 mm	-	QS18 R55F SME312 D12E D12	NA 11 3 42 25	BMP.753P

**M600** Available 315 °C models. Add w to end of model number (example, BA23SM600).

**M900** Available 480° C models. Add M900 to end of model number (example, BA23SM900).  
Dimensions may vary for these models.

NA: Not recommended.



Diffuse Glass Fibers

End Tip	Features	Minimum Bend Radius	Core Diameter	Temp	Typical Range (mm)		Models
	Straight exit; 38 mm width	19 mm	3.7 mm	M600	QS18 R55F SME312 D12E D12	75 120 30 180 155	BR2.53S
	Straight exit; 9.7 mm width	19 mm	3.2 mm	M600	QS18 R55F SME312 D12E D12	110 110 25 180 150	BR23S
	90° angle	19 mm	2.3 mm	M600	QS18 R55F SME312 D12E D12	45 65 20 135 125	BA1.53SMETA
	90° angle	19 mm	2.3 mm	M600	QS18 R55F SME312 D12E D12	50 60 20 135 125	BA1.53SMTA
	90° angle	19 mm	2.3 mm	M600	QS18 R55F SME312 D12E D12	30 60 20 135 125	BTETA1.53S
	Glass lens; withstands 315 °C Focuses light to .80 mm with ø 1.6 mm fiber						Contact factory for range information

M600 Available 315 °C models. Add M600 to end of model number (example, BA23SM600).

## Glass Fiber Optics Specifications

<b>Construction</b>	Combination of optical glass fiber, stainless steel or PVC, brass, molded thermoplastics, and optical-grade epoxy. Optical fiber is F2 core, EN1 clad, approx. 50 $\mu\text{m}$ diameter per strand. Flexible steel interlock sheathing is 302 stainless.
<b>Sensing Range</b>	Refer to the specific fiber optic to be used
<b>Bend Radius</b>	Inside bend radius must be 12 mm or greater for PVC covered fiber optic assemblies, and 25 mm or greater for stainless steel armored cable covered fibers
<b>Length</b>	Standard length for assemblies is 915 mm; see dimension diagrams Most models are available from the factory with shorter or longer cable lengths, up to 18 m max
<b>Length Dimension Tolerance</b>	<b>Overall assembly length:</b> $\pm 12$ mm per 300 mm of length <b>Shrink junction dimensions:</b> $\pm 12$ mm
<b>Implied Dimensional Tolerances</b>	<b>All dimensions are in millimeters:</b> x = $\pm 2.5$ mm, x.x = $\pm 0.25$ mm and x.xx = $\pm 0.12$ mm, unless specified.
<b>Operating Conditions</b>	Fiber assemblies with stainless-steel (SS) sheathing and metal end tips: $-140^{\circ}$ to $+249^{\circ}$ C Fiber assemblies with PVC sheathing and/or plastic end tips: $-40^{\circ}$ to $+105^{\circ}$ C Special order assemblies with SS sheathing and metal end tips and model suffix "M600": $-140^{\circ}$ to $+315^{\circ}$ C* Special order assemblies with SS sheathing and metal end tips and model suffix "M900": $-140^{\circ}$ to $+480^{\circ}$ C*; note dimensional changes from STD models  * sensing end tip only

▲ Application Notes and Warnings ▲

- 1** The ends of glass fiber optic assemblies are optically ground and polished. Care taken in this manufacturing process accounts for the light coupling efficiency of the fiber optic assembly. As a result, glass fiber assemblies cannot be shortened, spliced or otherwise modified.
- 2** Use caution when applying fiber optics in hazardous locations. Although fiber optic assemblies are by themselves, intrinsically safe, the sensor and associated electronics must be LOCATED IN A SAFE ENVIRONMENT. Alternatively, fiber optics may be used with sensor model SMI912FQD. This sensor is approved for use inside hazardous areas when used with an appropriate intrinsic barrier. Also, see NAMUR sensor models Q45AD9F and MIAD9F. Fiber optics do not necessarily provide a hermetic seal between a hazardous environment and the safe environment.
- 3** In applications where glass fibers are used to insulate the control from high voltage, specify silicone rubber, Teflon®, or high-density polyethylene sheathing with no reinforcing wire in the cable. It is the responsibility of the user to test each fiber optic assembly for insulation capacity.
- 4** Do not subject the fibers to sharp bends, pinching, repeated flexing or high levels of radiation.
- 5** When ordering fiber lengths in excess of 1 m, take into account light signal reduction of 5 percent per 300 mm of additional length.

Teflon® is a registered trademark of Dupont™.

## Additional Models Available

In addition to the configurations shown, Banner offers thousands of readily available alternative fiber models:

- Substitute PVC over monocoil sheathing for stainless steel
- Reduce or increase glass fiber optic bundle diameters  
Example: Change  $\varnothing$  3.18 mm bundle to  $\varnothing$  1.57 mm
- Substitute a rectangular-shaped fiber bundle (0.5 x 2.5 mm) for a circular bundle
- Change endtip material from brass to stainless steel
- Modify straight or angled probe tip dimensions
- Modify overall fiber length in intervals of 305 mm (standard lengths are 914 and 610 mm)



## Measurement

High-quality optical, ultrasonic, radar and measuring array sensors help to solve the most challenging measurement applications.

# MEASUREMENT

---

LASER **page 202**

ULTRASONIC **page 216**

RADAR **page 240**

ARRAYS **page 246**

TEMPERATURE &  
VIBRATION **page 260**





## Laser

Laser distance measurement sensors provide accurate non-contact measuring and monitoring of targets with varying color, shape and temperature.

Series	Description	Max Sensing Range	Dimensions H x W x D	Resolution	Housing Material	Power Supply
	<b>LTF</b> High-performance LTF Series Sensors detect targets regardless of color, material or sheen from up to 12 m away, straight-on or at an angle page 204	12 m	77 x 26 x 56 mm	0.3 to 3 mm	Die-cast zinc	12 to 30 V dc
	<b>LE</b> A laser sensor with a range of 100 up to 1000 mm right out of the box with 2-line LCD display easy adjustment, setup and use. page 206	1 m	60 x 26 x 56 mm	0.02 to 1.0 mm	Die-cast zinc	12 to 30 V dc
	<b>LH</b> High-precision laser measurement page 208	200 mm	80 x 33 x 65 mm	0.001 to 0.01 mm	Aluminum	18 to 30 V dc
	<b>LG</b> High-precision short-range laser measurement page 210	125 mm	55.3 x 20.2 x 82.3 mm	0.003 to 0.01 mm	Zinc alloy die-cast, plated and painted finish	12 to 30 V dc
	<b>LT3</b> Time-of-flight laser distance-gauging page 212	<b>Diffuse:</b> 5 m <b>Retro:</b> 50 m	68.5 x 35.3 x 87 mm	1.0 to 1.25 mm	ABS	12 to 24 V dc
	<b>LT7</b> Time-of-flight laser distance-gauging page 214	<b>Diffuse:</b> 10 m <b>Retro:</b> 250 m	93 x 42 x 95 mm	4.0 to 8.0 mm	ABS	18 to 30 V dc

OTHER AVAILABLE MODELS



Q4X page 34



Q50 Website Only



# LTF Series

## High-Performance Laser Time of Flight



- Best in class combination of range, repeatability and accuracy enable highly reliable target detection and precise distance measurement
- Two-line, eight-character display and push-button programming for easy setup, troubleshooting and real-time distance measuring
- Durable IP67 housing, high ambient light immunity and stable performance across temperatures provide reliable performance in challenging environments
- Advanced options, including delay timers, advanced triggered measurement modes and cross-talk avoidance

### LTF

Example Model Number: LTF12IC2LDQ

Family	Range (m)	Output	Laser Class	Sensing Mode	Connector
<b>LTF</b>	<b>12</b>	<b>I</b>	<b>C2</b>	<b>LD</b>	<b>Q</b>
	12 24	I = 4 to 20 mA analog and (1) NPN/PNP discrete U = 0 to 10 V analog and (1) NPN/PNP discrete K = Dual Discrete with IO-Link	C2 = Class 2	LD = Laser diffuse	Blank = 2 m Integral Cable Q = Rotatable M12 Euro QD QP = PVC M12 Euro Pigtail QD W/30 = 9 m intergal cable

NOTE: Discrete NPN/PNP is user configurable



 Connection Option: A model with a QD requires a mating cordset.

**M12/Euro-Style with Shield**  
Straight connector models listed; for right-angle, add **RA** to the end of the model number (example, **MQDEC2-506RA**)



**5-Pin**  
**MQDEC2-506**  
2 m (6.5')  
**MQDEC2-515**  
5 m (15')  
**MQDEC2-530**  
9 m (30')

Additional cordset information is available  
See page 758



**SMBLTFL**



**SMBLTFU**



**SMBAMSSLTFP**



**SMBLFFFA**

includes 3/8" bolt for mounting  
**SMBLFFAM10**  
includes 10 mm bolt for mounting  
**SMBLFFAM12**  
clamps directly onto industry standard bracket systems of 1/2" or 12 mm rods

Additional bracket information is available  
See page 724

LTF Specifications

<b>Supply Voltage and Current</b>	12 to 30 V dc														
<b>Normal Run Mode:</b>	< 2.1 W. Current consumption < 85 mA at 24 V dc														
<b>Sensing Beam</b>	Visible red laser; class 2														
<b>Beam Spot Size</b>	<table border="1"> <thead> <tr> <th>Distance (mm)</th> <th>Size</th> </tr> </thead> <tbody> <tr> <td>50</td> <td>6.5 mm</td> </tr> <tr> <td>7500</td> <td>10 mm</td> </tr> <tr> <td>12000</td> <td>12.5 mm</td> </tr> </tbody> </table>	Distance (mm)	Size	50	6.5 mm	7500	10 mm	12000	12.5 mm						
Distance (mm)	Size														
50	6.5 mm														
7500	10 mm														
12000	12.5 mm														
<b>Response Time</b>	<b>Fast:</b> 1.5 ms <b>Standard:</b> 8 ms <b>Medium:</b> 32 ms <b>Slow:</b> 256 ms														
<b>Range and Linearity / Accuracy</b>	<table border="1"> <thead> <tr> <th rowspan="2">Reflectance</th> <th colspan="2">Accuracy</th> </tr> <tr> <th>±10 mm</th> <th>±20 mm</th> </tr> </thead> <tbody> <tr> <td>6% Black Card</td> <td>5 m</td> <td>7 m</td> </tr> <tr> <td>18% Gray Card</td> <td>8 m</td> <td>11 m</td> </tr> <tr> <td>90% White Card</td> <td>12 m</td> <td>-</td> </tr> </tbody> </table>	Reflectance	Accuracy		±10 mm	±20 mm	6% Black Card	5 m	7 m	18% Gray Card	8 m	11 m	90% White Card	12 m	-
Reflectance	Accuracy														
	±10 mm	±20 mm													
6% Black Card	5 m	7 m													
18% Gray Card	8 m	11 m													
90% White Card	12 m	-													
<b>Repeatability</b> Slow 256 ms shown (for more info see datasheet)															
<b>Resolution</b>	< 0.3 to 3 mm*														
<b>Construction</b>	Die-cast zinc housing; acrylic window														
<b>Environmental Rating</b>	IEC IP67; NEMA 6														
<b>Connections</b>	5-Pin Threaded M12/Euro-Style Cordsets— with Shield														
<b>Operating Conditions</b>	<b>Temperature:</b> -20 to +55 °C <b>Humidity:</b> 90% at +55 °C maximum relative humidity (non-condensing)														
<b>Certifications</b>															

\* Resolution measured as twice repeatability with white target at slow response speed at 20 °C. See repeatability curves for more detail.

# LE Series

## Laser Sensor



- The LE laser sensors are ready to measure right out of the box with easy adjustment, setup and use.
- Easy adjustment with a two-line, eight-character intuitive display
- Repeatability and accuracy for challenging targets, from metal to black rubber
- Visible class 2 laser for small spot size and simple alignment

### LE

Example Model Number: LE550IQ

Family	Range	Output	Laser Class	Connector
<b>LE</b>	<b>550</b>	<b>I</b>	<b>Blank</b>	<b>Q</b>
	550 = 100-1000 mm 250 = 100-400 mm	I = 4 to 20 mA analog and (1) NPN/PNP discrete U = 0 to 10 V analog and (1) NPN/PNP discrete D = (2) NPN/PNP discrete K = Dual Discrete with IO-Link	Blank = Class 2 C1 = Class1	Blank = 2 m Integral Cable Q = Rotatable M12 Euro QD QP = PVC M12 Euro Pigtail QD W/30 = 9 m Integral Cable
NOTE: Discrete NPN/PNP is user configurable				

 Connection Option: A model with a QD requires a mating cordset.

**M12/Euro-Style with Shield**

Straight connector models listed; for right-angle, add **RA** to the end of the model number (example, **MQDEC2-506RA**)



5-Pin

- MQDEC2-506**  
2 m (6.5')
- MQDEC2-515**  
5 m (15')
- MQDEC2-530**  
9 m (30')



**SMBLEU**    **SMBLEL**    **SMBLEFA**

Additional bracket information is available  
See page 724

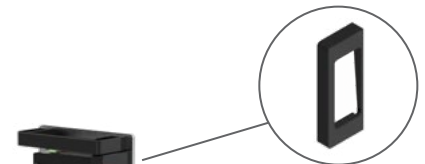

**RWAMSLE**  
replacement windows

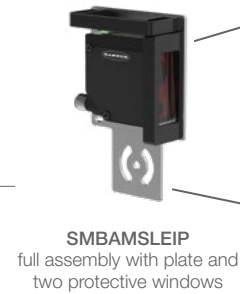

**SMBAMSLEIP**  
full assembly with plate and two protective windows

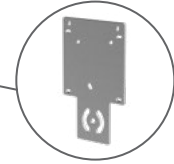

**SMBAMSLTFP**  
mounting plate

Additional cordset information is available  
See page 758



LE Specifications

Sensing Beam	Visible red Class 2 laser, 650 nm																																							
Supply Voltage and Current	12 to 30 V dc <b>Normal Run Mode:</b> 1.7 W, Current consumption less than 70 mA at 24 V dc																																							
Supply Protection Circuitry	Protected against reverse polarity and transient over voltages																																							
Spot Size	<div style="display: flex; align-items: center;"> <table border="1"> <thead> <tr> <th colspan="4">LE550 Models</th> <th colspan="3">LE250 Models</th> </tr> <tr> <th colspan="2"></th> <th colspan="3">Distance</th> <th colspan="3">Distance</th> </tr> <tr> <th></th> <th></th> <th>100 mm</th> <th>550 mm</th> <th>1000 mm</th> <th>100 mm</th> <th>250 mm</th> <th>400 mm</th> </tr> </thead> <tbody> <tr> <td>X</td> <td></td> <td>8.4 mm</td> <td>10.5 mm</td> <td>12.1 mm</td> <td>3.2 mm</td> <td>2.1 mm</td> <td>1.2 mm</td> </tr> <tr> <td>Y</td> <td></td> <td>3.5 mm</td> <td>4.2 mm</td> <td>4.9 mm</td> <td>2.2 mm</td> <td>1.5 mm</td> <td>0.9 mm</td> </tr> </tbody> </table> </div>	LE550 Models				LE250 Models					Distance			Distance					100 mm	550 mm	1000 mm	100 mm	250 mm	400 mm	X		8.4 mm	10.5 mm	12.1 mm	3.2 mm	2.1 mm	1.2 mm	Y		3.5 mm	4.2 mm	4.9 mm	2.2 mm	1.5 mm	0.9 mm
LE550 Models				LE250 Models																																				
		Distance			Distance																																			
		100 mm	550 mm	1000 mm	100 mm	250 mm	400 mm																																	
X		8.4 mm	10.5 mm	12.1 mm	3.2 mm	2.1 mm	1.2 mm																																	
Y		3.5 mm	4.2 mm	4.9 mm	2.2 mm	1.5 mm	0.9 mm																																	
Temperature Effect	LE250: ±0.03 to ±0.15 mm/°C LE550: ±0.25 to ±0.5 mm/°C																																							
Analog Linearity	LE250: ±0.375 to ±0.9 mm LE550: ±2 to ±4.5 mm																																							
Analog Resolution	LE550: Less than 0.5 mm (100 – 600 mm) Less than 1 mm (600 – 1000 mm) LE250: Less than 0.02 mm (100 – 250 mm) Less than 0.2 mm (250 – 400 mm)																																							
Construction	<b>Housing:</b> die-cast zinc <b>Lens:</b> polycarbonate																																							
Vibration/Mechanical Shock	IEC 60947-5-2																																							
Operating Conditions	<b>Temperature:</b> -20 to +55 °C <b>Humidity:</b> 90% at +55 °C																																							
Environmental Rating	IP67, NEMA 6																																							
Certifications																																								

# LH Series

## High-Precision Laser Measurement



- Highly precise laser technology of a 1024 pixel CMOS linear imager provides reliable and accurate measurement on most materials, including machined metal, wood, ceramic, paper and painted targets.
- Automatic laser power and measurement rate control for reliable measurement under changing or challenging conditions such as moving processes, hot parts, machined parts and a variety of colors and textures
- Robust, self-contained laser displacement sensor

### Class 2 Laser LH

Visible Red Laser

Sensing Mode	Measurement				Connection	Output	Spot Size at Reference Distance	Models
	Span	Start of Range	End of Range	Reference Distance				
 DIFFUSE LASER	10 mm	25 mm	35 mm	30 mm	8-pin Euro Pigtail QD	Analog 4-20 mA & RS-485	50 micron	LH30IX485QP
 DIFFUSE LASER	40 mm	60 mm	100 mm	80 mm	8-pin Euro Pigtail QD	Analog 4-20 mA & RS-485	125 micron	LH80IX485QP
 DIFFUSE LASER	100 mm	100 mm	200 mm	150 mm	8-pin Euro Pigtail QD	Analog 4-20 mA & RS-485	225 micron	LH150IX485QP

Connection options: A model with a QD requires a mating cordset.



**M12/Euro-Style with Shield**  
Straight connector models listed

**8-Pin**

- MQLH-806-F**  
2 m (6.5')
- MQLH-815-F**  
5 m (15')
- MQLH-830-F**  
9 m (30')

Additional cordset information is available  
See page 758



**Double Ended M12/Euro-Style with Shield**  
Straight connector models only

**8-Pin**

<b>Straight Male to Straight Female</b>	—	<b>Straight Male to Straight Male</b>
<b>MQLH-806-MF</b> 2.0 m (6')	—	<b>MQLH-801-MM</b> 0.3 m (1')
<b>MQLH-815-MF</b> 5 m (15')	—	—
<b>MQLH-830-MF</b> 9 m (30')	—	—



**Euro QD—Splitter with Shield**

**8-Pin**

- CSB-M1280M1280-LH**  
Branches 2 x 0 m
- CSB-M1281M1282-LH**  
Branches 2 x 0.6 m (2')
- Trunk 0.3 m (1')
- CSB3-M1281M1282-LH**  
Branches 3 x 0.6 m (2')
- Trunk 0.3 m (1')



**SMBLH1**    **SMBLH30**    **SMBLH80**    **SMBLH150**

Additional bracket information is available  
See page 724

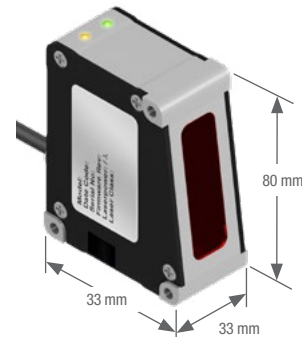

LH Specifications

<b>Sensing Beam</b>	670 nm (1mW) visible red IEC and CDRH Class 2 laser		
<b>Supply Voltage and Current</b>	18 to 30 V dc (10% max. ripple); 250 mA max. @ 24 V dc (exclusive of load)		
<b>Supply Protection Circuitry</b>	Protected against reverse polarity and transient over voltages		
<b>Delay at Power-up</b>	1.25 seconds		
<b>Temperature Effect</b>	0.01% of measurement range/ °C		
<b>Linearity</b>	0.1% of measurement range		
<b>Resolution</b>	<b>LH30:</b> 1 µm	<b>LH80:</b> 4 µm	<b>LH150:</b> 10 µm Resolution obtained with an average of 64 readings on a white ceramic target
<b>Ambient Light</b>	≤ 3000 Lux		
<b>Measurement Frequency</b>	Dynamically adjusted from 300 to 4000 Hz depending on target conditions, or locked via LH Series configurator software		
<b>Indicators</b>	<b>Green:</b> Power ON; Flashing = target at reference distance <b>Orange:</b> Target inside measurement range		
<b>Construction</b>	<b>Housing:</b> Aluminum	<b>Cover:</b> Aluminum	<b>Lens:</b> Glass <b>Cable:</b> PVC and nickel-plated brass
<b>Environmental Rating</b>	IP67		
<b>Output Configuration</b>	<b>Analog current output:</b> 4 to 20 mA (current sourcing) <b>Analog output rating:</b> 1 kΩ max. @ 24 V dc, max. load resistance = [(Vcc-4.5)/0.02]Ω		
<b>Operating Conditions</b>	<b>Operating Temperature:</b> -10 to +45 °C <b>Storage Temperature:</b> -10 to +80 °C <b>Maximum relative humidity:</b> 85% at +45 °C, non-condensing		
<b>Vibration and Mechanical Shock</b>	<b>Vibration:</b> 60 Hz, 30 minutes, 3 axes <b>Shock:</b> 30G for 11 milliseconds, half sine wave, 3 axes		
<b>Application Notes</b>	Allow 30-minute warm-up for specified performance		
<b>Factory Default Settings</b>	<b>Mode:</b> Displacement Mode <b>Sensor Address:</b> Unset (address 0) <b>Baud Rate:</b> 115200 <b>Analog Output:</b> 4-20 mA, positive slope, full range		

Certifications 

# LG Series

## High-Precision Short-Range Laser Measurement



- The LG5 uses an ultra-narrow beam for applications requiring precise measurement of distance, height or thickness as well as gauging applications
- Replaces two-piece laser gauging sensors with completely self-contained, compact housing
- Houses discrete (switched) and analog outputs in the same unit, each independently programmable

### Diffuse LG5

Visible Red Laser

Sensing Mode	Laser Class	Sensing Distance	Beam Size	Connection	Analog Output	Models NPN	Models PNP
 DIFFUSE LASER	Class 2	45-60 mm	<b>At 53 mm:</b> 0.4 mm x 0.6 mm  <b>Focus:</b> 70 mm	2 m	0-10 V dc	LG5A65NU	LG5A65PU
				8-pin Euro Pigtail QD		LG5A65NUQ	LG5A65PUQ
 DIFFUSE LASER	Class 2	45-60 mm	<b>At 53 mm:</b> 0.1 mm  <b>Focus:</b> 53 mm	2 m	0-10 V dc	LG5B65NU	LG5B65PU
				8-pin Euro Pigtail QD		LG5B65NUQ	LG5B65PUQ
 DIFFUSE LASER	Class 2	45-60 mm	<b>At 53 mm:</b> 0.1 mm  <b>Focus:</b> 53 mm	2 m	4-20 mA	LG5A65NI	LG5A65PI
				8-pin Euro Pigtail QD		LG5A65NIQ	LG5A65PIQ
 DIFFUSE LASER	Class 2	45-60 mm	<b>At 53 mm:</b> 0.1 mm  <b>Focus:</b> 53 mm	2 m	4-20 mA	LG5B65NI	LG5B65PI
				8-pin Euro Pigtail QD		LG5B65NIQ	LG5B65PIQ

### Diffuse LG10

Visible Red Laser

Sensing Mode	Laser Class	Sensing Distance	Beam Size	Connection	Analog Output	Models NPN	Models PNP
 DIFFUSE LASER	Class 2	75-125 mm	<b>At 125 mm:</b> 0.6 mm x 0.8 mm  <b>Focus:</b> 180 mm	2 m	0-10 V dc	LG10A65NU	LG10A65PU
				8-pin Euro Pigtail QD		LG10A65NUQ	LG10A65PUQ
 DIFFUSE LASER	Class 2	75-125 mm	<b>At 125 mm:</b> 0.6 mm x 0.8 mm  <b>Focus:</b> 180 mm	2 m	4-20 mA	LG10A65NI	LG10A65PI
				8-pin Euro Pigtail QD		LG10A65NIQ	LG10A65PIQ

Connection options: A model with a QD requires a mating cordset.

For 9 m cable, add suffix **W/30** to the 2 m model number (example, **LG10A65PU W/30**).





Additional cordset information is available  
 See page 758

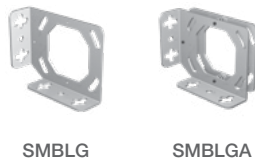

Additional bracket information is available  
 See page 724



LG5 and LG10 Specifications

<b>Sensing Beam</b>	650 nm visible Red IEC and CDRH Class 2 laser; 0.20 mW max. radiant output power	
<b>Supply Voltage and Current</b>	12 to 30 V dc (10% max. ripple); 50 mA max. @ 24 V dc (exclusive of load)	
<b>Supply Protection Circuitry</b>	Protected against reverse polarity and transient overvoltages	
<b>Delay at Power-up</b>	1.25 second	
<b>Output Rating</b>	<b>Discrete (switched) and Alarm outputs:</b> 100 mA max. <b>OFF-state leakage current:</b> less than 5 µA Output saturation voltage <b>PNP outputs:</b> less than 1.2 V at 10 mA and less than 1.6 V at 100 mA <b>NPN outputs:</b> less than 200 mV at 10 mA and less than 600 mV at 100 mA <b>Analog Current output:</b> 1 kΩ max. @ 24 V dc, max. load resistance = [(Vcc - 4.5)/0.02]Ω <b>Analog Voltage output:</b> 2.5 kΩ min. load impedance	
<b>Output Configuration</b>	Discrete (switched) & alarm outputs: Solid-state switch; choose NPN (current sinking) or PNP (current sourcing) models Analog output: 4 to 20 mA (current sourcing) or 0 to 10 V dc (voltage sourcing), depending on model	
<b>Output Protection</b>	Discrete and alarm outputs are protected against continuous overload and short circuit	
<b>Output Response Time</b>	Discrete Outputs (ON/OFF) <b>Fast:</b> 2.0 milliseconds <b>Medium:</b> 10 milliseconds <b>Slow:</b> 100 milliseconds Analog Output (-3dB) <b>Fast:</b> 450 Hz (1 millisecond average/1 millisecond update rate) <b>Medium:</b> 45 Hz (10 millisecond average/2 millisecond update rate) <b>Slow:</b> 4.5 Hz (100 millisecond average/5 millisecond update rate)	
<b>Analog Resolution and Repeatability of Discrete Trip Point*</b>	<b>LG5: Fast:</b> Less than 40 µm @ 50 mm <b>Medium:</b> Less than 12 µm @ 50 mm <b>Slow:</b> Less than 3 µm @ 50 mm	<b>LG10: Fast:</b> Less than 150 µm @ 100 mm <b>Medium:</b> Less than 50 µm @ 100 mm <b>Slow:</b> Less than 10 µm @ 100 mm
<b>Analog Linearity*</b>	<b>LG5:</b> +/- 60 µm over 45 to 60 mm sensing window +/- 10 µm over 49 to 51 mm sensing window	<b>LG10:</b> +/- 200 µm over 75 to 125 mm sensing window +/- 20 µm over 95 to 100 mm sensing window
	*Resolution and linearity specified @ 24 V dc, 22 °C, using a white ceramic test surface (see Application Notes)	
<b>Minimum Window Size (Analog or Discrete)</b>	<b>LG5:</b> 1.5 mm	<b>LG10:</b> 5 mm
<b>Discrete Output Hysteresis</b>	<b>LG5:</b> Less than 0.2 mm	<b>LG10:</b> Less than 1.0 mm
<b>Color Sensitivity (typical)</b>	<b>LG5:</b> Less than 75 µm for white to dark gray ceramic target	<b>LG10:</b> Less than 100 µm for white to dark gray ceramic target
<b>Temperature Effect</b>	<b>LG5:</b> +/- 7 µm/ °C	<b>LG10:</b> +/- 25 µm/ °C
<b>Adjustments</b>	<b>Response speed:</b> Push button toggles between Slow, Medium, and Fast (see Output Response Time) <b>Window limits (analog or discrete):</b> TEACH-mode programming of near and far window limits. Limits may also be taught remotely using TEACH wire <b>Analog output slope:</b> The first limit taught is assigned to the minimum analog output (0 V dc or 4 mA)	
<b>Indicators</b>	<b>Green Power ON LED:</b> Indicates when power is ON, overloaded output and laser status <b>Yellow Output LED:</b> Indicates when discrete load output is conducting <b>Red Signal LED:</b> Indicates when target is within sensing range and the condition of the received light signal <b>Tri-color Red/Green/Yellow TEACH LED:</b> Indicates sensor is ready for programming each limit (indicates Red for analog output, Green for discrete, and Yellow for simultaneous analog and discrete) <b>Yellow Fast/Slow LEDs:</b> Combination of 2 lights ON or OFF indicates 1 of 3 response speeds	
<b>Construction</b>	<b>Housing:</b> Zinc alloy die-cast, plated and painted finish	<b>Cover plate:</b> Aluminum with painted finish <b>Lens:</b> Acrylic
<b>Environmental Rating</b>	IP67; NEMA 6	
<b>Operating Conditions</b>	<b>Temperature:</b> -10 to +50 °C	<b>Relative humidity:</b> 90% at 50 °C (non-condensing)
<b>Vibration and Mechanical Shock</b>	<b>Vibration:</b> 60 Hz, 30 minutes, 3 axes <b>Shock:</b> 30G for 11 milliseconds, half sine wave, 3 axes	
<b>Certifications</b>		

# LT3 Series

## Time-of-Flight Laser Distance-Gauging Sensors



- The LT3 uses advanced “time-of-flight” technology for precise, long-distance gauging.
- Reliably detects targets regardless of angles
- Visible red laser spot for easy alignment
- Offers push-button programming for other output response times or remote programming for added security and convenience

### Diffuse LT3, Class 2 Laser

Visible Red Laser

Sensing Mode	Range	Connection	Analog Output	Models NPN	Models PNP
<p>DIFFUSE LASER</p>	0.3 to 5 m*	2 m	None	LT3BD (Dual NPN or PNP selectable)	
		8-pin Euro QD		LT3BDQ (Dual NPN or PNP selectable)	
	0.3 to 5 m*	2 m	0 to 10 V dc	LT3NU	
		8-pin Euro QD		LT3NUQ	
	0.3 to 5 m*	2 m	4 to 20 mA	LT3NI	
		8-pin Euro QD		LT3NIQ	

### Retro LT3, Class 1 Laser

Visible Red Laser

Sensing Mode	Range	Connection	Analog Output	Models NPN	Models PNP
<p>LASER RETRO</p>	0.5 to 50 m†	2 m	None	LT3BDLV (Dual NPN or PNP selectable)	
		8-pin Euro QD		LT3BDLVQ (Dual NPN or PNP selectable)	
	0.5 to 50 m†	2 m	0 to 10 V dc	LT3NULV	
		8-pin Euro QD		LT3NULVQ	
	0.5 to 50 m†	2 m	4 to 20 mA	LT3NULVQ	
		8-pin Euro QD		LT3NULVQ	

Connection options: A model with a QD requires a mating cordset.

For 9 m cable, add suffix W/30 to the 2 m model number (example, LT3BD W/30).

\* Based on a 90% reflectivity white card

† Retroreflective range is specified using a BRT-TVHG-8X10P high-grade target.

Actual sensing range may differ, depending on the efficiency and reflective area of the retroreflector used. See Accessories for more information.



Euro QD (w/ Shield)  
Straight connector models only

**8-Pin**  
**MQDC-806**  
 2 m (6')  
**MQDC-815**  
 5 m (15')  
**MQDC-830**  
 9 m (30')



SMBLT31



SMBLT32



SMBLT3IP



Additional cordset information is available  
See page 758

Additional bracket information is available  
See page 724

Reflectors



Additional information is available  
See page 790

L-GAGE® LT3 Specifications

<b>Sensing Beam</b>	<b>Typical beam diameter:</b> 6 mm @ 3 m <b>Typical laser lifetime:</b> 75,000 hours <b>Diffuse:</b> 658 nm visible red IEC and CDRH Class 2 laser; 0.5 mW max. radiant output power <b>Retroreflective:</b> 658 nm visible red IEC and CDRH Class 1 laser; 0.15 mW max. radiant output power	
<b>Sensing Range</b>	<b>Diffuse:</b> <b>90% white card:</b> 0.3 to 5 m <b>18% gray card:</b> 0.3 to 3 m <b>6% black card:</b> 0.3 to 2 m	<b>Retroreflective:</b> 0.5 to 50 m (using supplied target)
<b>Supply Voltage and Current</b>	12 to 24 V dc (10% max. ripple); 108 mA max. @ 24 V dc or [2600/V dc] mA	
<b>Supply Protection Circuitry</b>	Protected against reverse polarity and transient voltages	
<b>Delay at Power-up</b>	1 second; outputs do not conduct during this time	
<b>Output Rating</b>	<b>Discrete (switched) output:</b> 100 mA max. <b>OFF-state leakage current:</b> less than 5 µA <b>Output saturation NPN:</b> less than 200 mV @ 10 mA; less than 600 mV @ 100 mA <b>Output saturation PNP:</b> less than 1.2 V at 10 mA; less than 1.6 V at 100 mA <b>Analog voltage output:</b> 2.5 kΩ min. load impedance (voltage sourcing) <b>Analog current output:</b> 1 kΩ max. @ 24V; max. load resistance = [Vcc-4.5/0.02 Ω] (current sourcing)	
<b>Output Protection</b>	Protected against short circuit conditions	
<b>Output Response Time</b>	<b>Discrete output</b> <b>Fast:</b> 1 millisecond ON/OFF <b>Medium:</b> 10 milliseconds ON/OFF <b>Slow:</b> 100 milliseconds ON/OFF <b>Diffuse Analog Voltage output (-3 dB)</b> <b>Fast:</b> 450 Hz (1 ms average/1 ms update rate) <b>Medium:</b> 45 Hz (10 ms average/2 ms update rate) <b>Slow:</b> 4.5 Hz (100 ms average/4 ms update rate)	
<b>Color Sensitivity (typical)</b>	<b>Diffuse:</b> 90% white to 18% gray: less than 10 mm; 90% white to 6% black: less than 20 mm. <b>Retroreflective Analog Voltage output (-3 dB)</b> <b>Fast:</b> 114 Hz (6 ms average/ 1 ms update rate) <b>Medium:</b> 10 Hz (48 ms average/ 1 ms update rate) <b>Slow:</b> 2.5 Hz (192 ms average/ 1 ms update rate)	
<b>Analog Linearity</b>	<b>Retroreflective:</b> ± 60 mm from 0.5 to 50 m (0.12% of full scale) (Specified @ 24 V dc, 22° C using supplied BRT-TVHG-8X10P retroreflector)	
<b>Discrete Output Hysteresis</b>	<b>Diffuse</b> <b>Fast:</b> 10 mm <b>Medium:</b> 5 mm <b>Slow:</b> 3 mm	<b>Retroreflective</b> <b>Fast:</b> 20 mm <b>Medium:</b> 10 mm <b>Slow:</b> 6 mm
<b>Temperature Effect</b>	<b>Diffuse:</b> less than 2 mm/° C <b>Retroreflective:</b> less than 3 mm/° C	
<b>Minimum Window Size</b>	<b>Diffuse:</b> 20 mm <b>Retroreflective:</b> 40 mm	
<b>Remote TEACH Input</b>	18 kΩ min. (65 kΩ at 5 V dc)	
<b>Remote TEACH</b>	<b>To teach:</b> Connect yellow wire to +5 to 24 V dc <b>To disable:</b> Connect yellow wire to 0 to +2 V dc (or open connection)	
<b>Construction</b>	<b>Housing:</b> ABS/polycarbonate blend <b>Window:</b> Acrylic <b>Quick-disconnect:</b> ABS/polycarbonate blend	
<b>Environmental Rating</b>	IP67; NEMA 6	
<b>Operating Conditions</b>	<b>Temperature:</b> 0 to +50 °C <b>Relative humidity:</b> 90% at 50 °C (non-condensing)	

Certifications



# LT7 Series

## Time-of-Flight Laser Distance-Gauging Sensors



- Visible red laser spot during programming mode for easy alignment
- Features TEACH-mode programming using integrated push-buttons or a serial interface
- Onboard LCD display for easy troubleshooting
- Long-range retroreflective models up to 250 m and diffuse models up to 10 m

### Diffuse L-GAGE® LT7

Infrared Laser

Sensing Mode	Laser Class	Sensing Distance*	Connection	Discrete Output	Analog Output	Serial	Models
DIFFUSE LASER	Class 1 Infrared Sensing Laser (Class 2 Visible Red Alignment Laser)	0.5 to 10 m	12-pin M16 QD	2 PNP	4-20 mA	RS-422 or SSI	LT7PIDQ

### Retro L-GAGE® LT7

Infrared Laser

Sensing Mode	Laser Class	Sensing Distance*	Connection	Discrete Output	Analog Output	Serial	Models
RETRO LASER	Class 1 Infrared Sensing Laser (Class 2 Visible Red Alignment Laser)	0.5 to 250 m	12-pin M16 QD	2 PNP	—	RS-422 or SSI	LT7PLVQ

Connection options: A model with a QD requires a mating cordset.  
 \*Diffuse-mode range specified using a 90% reflectance white card.  
 Retroreflective range is specified using a BRT-250, BRT-540 or BRT-700 retroreflective target (see page page 790).



**Euro QD (w/ Shield)**  
Straight connector models listed; for right-angle, replace **ST** with **RA** at the end of the model number (example, **MQDC-1210RA**)

**12-Pin**  
**MQDC-1210ST** 3 m  
**MQDC-1213ST** 10 m

Additional cordset information is available  
See page 758



**SMBLT7**

Additional bracket information is available  
See page 724



**Reflectors**



Additional information is available  
See page 790

**L-GAGE® LT7 Specifications**









<b>Sensing Range</b>	<b>LT7PLVQ:</b> 0.5 to 250 m (using specified reflector) <b>LT7PIDQ: 6% Black card:</b> 0.5 to 3 m <b>18% Gray card:</b> 0.5 to 7 m <b>90% White card:</b> 0.5 to 10 m																														
<b>Supply Voltage and Current</b>	18 to 30 V dc (10% max. ripple)																														
<b>Power Consumption</b>	Less than 4.5 W @ 25° C																														
<b>Measuring Laser</b>	Infrared, 900 nm, Class 1																														
<b>Laser Control</b>	Measurement laser is ON when sensor is ON. Pilot (visible) laser enabled during Programming mode; alternates with measurement laser.																														
<b>Spot Size</b>	<table border="0"> <tr> <td></td> <td><b>Distance</b></td> <td><b>Spot Size</b></td> <td></td> <td><b>Distance</b></td> <td><b>Spot Size</b></td> </tr> <tr> <td><b>LT7PLVQ:</b></td> <td>10 m</td> <td>ø 20 mm</td> <td><b>LT7PIDQ:</b></td> <td>4 m</td> <td>3 x 10 mm</td> </tr> <tr> <td></td> <td>50 m</td> <td>ø 100 mm</td> <td></td> <td>6 m</td> <td>4 x 12 mm</td> </tr> <tr> <td></td> <td>100 m</td> <td>ø 200 mm</td> <td></td> <td>10 m</td> <td>10 x 20 mm</td> </tr> <tr> <td></td> <td>250 m</td> <td>ø 500 mm</td> <td></td> <td></td> <td></td> </tr> </table>		<b>Distance</b>	<b>Spot Size</b>		<b>Distance</b>	<b>Spot Size</b>	<b>LT7PLVQ:</b>	10 m	ø 20 mm	<b>LT7PIDQ:</b>	4 m	3 x 10 mm		50 m	ø 100 mm		6 m	4 x 12 mm		100 m	ø 200 mm		10 m	10 x 20 mm		250 m	ø 500 mm			
	<b>Distance</b>	<b>Spot Size</b>		<b>Distance</b>	<b>Spot Size</b>																										
<b>LT7PLVQ:</b>	10 m	ø 20 mm	<b>LT7PIDQ:</b>	4 m	3 x 10 mm																										
	50 m	ø 100 mm		6 m	4 x 12 mm																										
	100 m	ø 200 mm		10 m	10 x 20 mm																										
	250 m	ø 500 mm																													
<b>Pilot Laser (Alignment)</b>	Visible red, 650 nm, Class 2																														
<b>Discrete &amp; Analog Output Protection</b>	Protected against continuous overload and short circuit																														
<b>Discrete Outputs</b>	(2) 100 mA, PNP																														
<b>Discrete Switch Points</b>	Adjustable in 1 mm steps																														
<b>Discrete Output Hysteresis</b>	Adjustable, 10 mm min.																														
<b>Alarm Outputs</b>	50 mA, PNP (NO)																														
<b>Analog Output</b>	<b>LT7PLVQ:</b> None <b>LT7PIDQ:</b> 4-20 mA																														
<b>Output Response Time</b>	12 milliseconds																														
<b>Linearity</b>	±10 mm																														
<b>Resolution/Repeatability</b>	<b>LT7PLVQ:</b> ±2 mm <b>LT7PIDQ:</b> ±4 mm																														
<b>Temperature Effect</b>	Less than ± 5 mm over the total sensing range																														
<b>Minimum Analog Window Size</b>	<b>LT7PLVQ:</b> Not Applicable <b>LT7PIDQ:</b> 300 mm																														
<b>Adjustments</b>	Push-button directed password enable/disable, measurement unit select, offset value select, output limits set, output mode select, analog output slope select (diffuse models only) and output limit manual adjust. See datasheet for information.																														
<b>Serial Measurement Speed</b>	<b>SSI:</b> 1.4 milliseconds (SSI cycle 80 microseconds) <b>RS-422:</b> 2.9 milliseconds @ 57.6 kBaud																														
<b>Construction</b>	ABS shock-resistant housing; PMMA window; polycarbonate displays																														
<b>Weight</b>	Approximately 230 g																														
<b>Environmental Rating</b>	IEC IP67																														
<b>Operating Conditions</b>	<b>Temperature:</b> -10 to +50 °C in continuous operation																														
<b>Storage Temperature</b>	-30 to +75 °C																														
<b>Vibration/Shock</b>	EN 60947-5-2																														





## Ultrasonic

Ultrasonic sensors use sound waves rather than light, making them ideal for stable detection of uneven surfaces, liquids, clear objects, and objects in dirty environments. These sensors work well for applications that require precise measurements between stationary and moving objects.

Series	Description	Max Sensing Range	Dimensions H x W x D (mm)	Protection Rating	Housing Material	Power Supply
	<b>QT50U</b> The QT50U features a completely sealed, shock-resistant housing that is ideal for monitoring levels of liquids and solids. page 218	8 m	84.2 x 74.1 x 67.4	IP67; NEMA 6P	ABS/ Polycarbonate	10 to 30 V dc, 85 to 264 V ac
	<b>S18U</b> The S18U is ideal for material handling and packaged goods applications, such as bottling or liquid level detection and as a control for small containers. page 222	300 mm	80.8 x ø 18	IP67; NEMA 6P	Thermoplastic polyester	10 to 30 V dc
	<b>T30U/T30UX</b> The T30UX features T-style, right-angle sensor package with a 30 mm threaded barrel and a wide variety of mounting options. page 226	3 m	51.5 x 40 x 45	IP67; NEMA 6	PTB polyester	10 to 30 V dc, 12 to 24 V dc, 15 to 24 V dc
	<b>M25U</b> The M25U Ultrasonic Sensor features a smooth 316 series stainless steel construction to withstand the toughest sanitary challenges. page 226	500 mm	103 x ø 25	IP67; NEMA 6, IP69K	316 Stainless Steel	10 to 30 V dc
	<b>T18U</b> The T18U offers versatile mounting, and a response time of 1 millisecond. page 230	600 mm	51.5 x 40 x 30	IP67; NEMA 6P	PTB polyester	12 to 30 V dc
	<b>Q45U</b> The Q45U accepts programming storage cards for fast and easy sensing parameter changes. page 232	3 m	87.6 x 44.5 x 60.5	IP67; NEMA 6P	PTB polyester	12 to 24 V dc, 15 to 24 V dc
	<b>Q45UR</b> The Q45UR has sensing head choices of 18 mm diameter threaded barrel housing in plastic or stainless steel, or ultra-compact plastic Flat-Pak. page 234	250 mm	87.6 x 44.5 x 60.5 (Remote sensors vary by model)	IP67; NEMA 6P	Thermoplastic polyester	12 to 24 V dc, 15 to 24 V dc
	<b>QS18U</b> The QS18U senses clear and transparent materials, as well as color variations, including clear web material, clear or shiny bottles, highly reflective surfaces and liquid or dry bulk materials inside cramped locations. page 236	500 mm	41.5 x 15 x 33.5	IP67 or IP68; NEMA 6P	ABS	12 to 30 V dc
	<b>K50U</b> Designed for plug-and-play use with the Q45U wireless node, creating a cost-effective and easy-to-use solution for monitoring mobile or remote tanks and totes page 238	3 m	59.5 x ø 50	IP67 NEMA 6P	PTB polyester	3.6 to 5.5 V dc or 10 to 30 V dc



# QT50U Series

## Long-Range Ultrasonic Sensors



- Features a small ultrasonic dead zone of 200 mm
- Available in a chemically resistant model with a Teflon® flange
- Detects targets at long ranges within confined areas, such as a storage tank, without interference from the tank walls
- Push-button and remote TEACH-mode programming with an external switch, computer or controller for added security and convenience

### QT50U, 10-30 V DC

Range	Connection	Output	Models*
200 mm to 8 m	2 m	Selectable 0 to 10 V dc or 4 to 20 mA	QT50ULB
	5-pin Mini QD		QT50ULBQ
	5-pin Euro QD		QT50ULBQ6
200 mm to 8 m	2 m	Selectable Dual NPN or PNP	QT50UDB
	5-pin Mini QD		QT50UDBQ
	5-pin Euro QD		QT50UDBQ6

### QT50U Universal Voltage, 85-264 V AC/48-250 V DC

Range	Connection	Output Operation Mode	Output	Models*
200 mm to 8 m	2 m	Window-limit (complementary outputs)	SPDT e/m relay	QT50UVR3W
	5-pin Micro QD			QT50UVR3WQ1
	5-pin Mini QD			QT50UVR3WQ
200 mm to 8 m	2 m	Pump/level control (pump-in and pump-out logic)	SPDT e/m relay	QT50UVR3F
	5-pin Micro QD			QT50UVR3FQ1
	5-pin Mini QD			QT50UVR3FQ

For more specifications see page 220-221.

 Connection options: A model with a QD requires a mating cordset.

For 9 m cable, add suffix W/30 to the 2 m model number (example, QT50ULB W/30).

\* For sensors with Teflon®-protected face and transducer, add suffix -CRFV to the model number (example, QT50ULB-CRFV).

Teflon® is a registered trademark of Dupont™.



5-Pin

**Euro-Style with Shield**

Straight connector models listed; for right-angle, add **RA** to the end of the model number (example, **MQDEC2-506RA**)

- MQDEC2-506**  
2 m (6.5')
- MQDEC2-55**  
5 m (15')
- MQDEC2-530**  
9 m (30')



5-Pin

**Micro-Style**

Straight connector models listed; for right-angle, add **RA** to the end of the model number (example, **MQVR3S-506RA**)

- MQVR3S-506**  
2 m (6.5')
- MQVR3S-515**  
5 m (15')
- MQVR3S-50**  
9 m (30')



5-Pin

**Mini-Style**

Straight connector models only

- MBCC2-506**  
2 m (6.5')
- MBCC2-512**  
4 m (15')
- MBCC2-530**  
9 m (30')

Additional cordset information is available  
See page 758



SMB30A



SMB30MM



SMB30SC

Additional bracket information is available  
See page 725



DC and Universal Voltage Models



Teflon®-protected Models  
(Suffix -CRFV)

## QT50U DC Specifications

Supply Voltage and Current	<b>Analog models:</b> 10 to 30 V dc (10% max. ripple); 100 mA max @ 10 V, 40 mA max. @ 30 V (exclusive of load) <b>Dual-discrete models:</b> 10 to 30 V dc (10% max. ripple); 100 mA max. @ 10 V, 40 mA @ 30 V (exclusive of load)
Ultrasonic Frequency	75 kHz burst, rep. rate 96 milliseconds
Supply Protection Circuitry	Protected against reverse polarity and transient overvoltages
Output Protection	Protected against short circuit conditions
Delay at Power-up	1.5 seconds
Output Configuration	<b>Analog models: Voltage sourcing:</b> 0 to 10 V dc <b>Current sourcing:</b> 4 to 20 mA <b>Dual-discrete models:</b> Dual PNP or NPN, selectable using DIP switch
Output Ratings	<b>Analog Voltage Output:</b> 0 to 10 V dc Minimum load resistance = 500 Ω Minimum required supply voltage for full 0-10 V output span = $(\frac{1000 + 13}{R_{LOAD}}) V$ dc <b>Analog Current Output:</b> 4 to 20 mA Maximum load resistance = 1 kΩ or $(\frac{V_{supply} - 5}{0.02}) \Omega$ , whichever is lower Minimum required supply voltage for full 4-20 mA output span = 10 V dc or $[(R_{Load} \times 0.02) + 5] V$ dc, whichever is greater. 4-20 mA output calibrated at 25° C with 250 Ω load. <b>Discrete Output:</b> 150 mA max. <b>OFF-State leakage current:</b> less than 5 μA <b>Output saturation: NPN:</b> less than 200 mV @ 10 mA; less than 650 mV @ 150 mA <b>PNP:</b> less than 1.2 V @ 10 mA; less than 1.65 V @ 150 mA
Temperature Effect	<b>Uncompensated:</b> 0.2% of distance/° C <b>Compensated:</b> 0.02% of distance/° C
Linearity (Analog Models)	+/- 0.2% of span from 200 to 8000 mm; +/- 0.1% of span from 500 to 8000 mm (1 mm minimum)
Resolution/Repeatability	1.0 mm
Hysteresis	5 mm
Output Response Time	<b>Analog models:</b> 100 to 2300 milliseconds <b>Dual-discrete models:</b> 100 to 1600 milliseconds
Minimum Window Size	20 mm
Adjustments	<b>Sensing window limits:</b> TEACH-Mode programming of near and far window limits may be set using the buttons or remotely using TEACH input
Indicators	<b>Green Power ON LED:</b> Indicates power is ON <b>Red Signal LED:</b> Indicates target is within sensing range, and the condition of the received signal <b>Teach/Output indicator (bicolor Yellow/Red):</b> <b>Yellow:</b> Target is within taught limits <b>Yellow OFF (Discrete):</b> Target is outside taught window limits <b>Red:</b> Sensor is in TEACH mode <b>Yellow Flashing (Analog):</b> Target is outside taught window limits
Remote TEACH	See data sheet
Construction	<b>Transducer:</b> Ceramic/Epoxy composite <b>Housing:</b> ABS/Polycarbonate <b>Membrane Switch:</b> Polyester <b>Lightpipes:</b> Acrylic
Environmental Rating	Leakproof design is rated IEC IP67; NEMA 6P
Operating Conditions	<b>Temperature:</b> -20 to +70 °C <b>Relative humidity:</b> 100%
Vibration and Mechanical Shock	All models meet Mil Std. 202F requirements. Method 201A (vibration: 10 to 60Hz max., double amplitude 0.06", maximum acceleration 10G). Also meets IEC 947-5-2 requirements: 30G 11 milliseconds duration, half sine wave.
Temperature Warmup Drift	Less than 0.8% of sensing distance upon power-up with Temperature Compensation enabled
Application Notes	1. Objects passing inside the specified near limit (200 mm ) may produce a false response 2. For best accuracy, allow 30 minute warm-up before programming or operating
Certifications	

## QT50U Universal Voltage Specifications

Supply Voltage	85 to 264 V ac, 50/60 Hz/48 to 250 V dc (1.5 watts max., exclusive of load)
Ultrasonic Frequency	75 kHz burst, rep. rate 96 milliseconds
Supply Protection Circuitry	Protected against transient over voltages. DC hookup is without regard to polarity.
Output Protection	Protected against short circuit conditions
Delay at Power-up	1.5 seconds
Output Configuration	SPDT (Single-Pole, Double-Throw) electromechanical relay output One normally open (NO) and one normally closed (NC)
Output Ratings	<p><b>Max. switching power (resistive load):</b> 2000 VA, 240 W (1000 VA, 120 W for sensors with Micro QD)</p> <p><b>Max. switching voltage (resistive load):</b> 250 V ac, 125 V dc</p> <p><b>Max. switching current (resistive load):</b> 8A @ 250 V ac, 8A @ 30 V dc derated to 200 mA @ 125 V dc (4A max. for sensors with Micro QD)</p> <p><b>Min. voltage and current:</b> 5 V dc, 10 mA</p> <p><b>Mechanical life of relay:</b> 50,000,000 operations</p> <p><b>Electrical life of relay at full resistive load:</b> 100,000 operations</p> <p>NOTE: Transient suppression is recommended when switching inductive loads</p>
Temperature Effect	<b>Uncompensated:</b> 0.2% of distance/ °C <b>Compensated:</b> 0.02% of distance/ °C
Repeatability	1.0 mm
Hysteresis	<b>Window-limit sensor models:</b> 5 mm <b>Fill-level control sensor models:</b> 0 mm
Output Response Time	Selectable 1600, 400 or 100 milliseconds
Minimum Window Size	20 mm
Adjustments	<p><b>Sensing limits:</b> TEACH-Mode programming of near and far limits may be set using the TEACH push button</p> <p><b>Sensor configuration:</b> Output response time and temperature compensation mode may be set using the Speed push button</p> <p><b>Factory default settings:</b> 400 milliseconds output response time; temperature compensation enabled</p>
Indicators	<p><b>Green Power ON LED:</b> Indicates power is ON</p> <p><b>Red Signal LED:</b> Indicates target is within sensing range, and the condition of the received signal</p> <p><b>Output indicator (bicolor Yellow/Red):</b> Indicates output status or TEACH mode</p> <p><b>Response indicator (bicolor Yellow/Red):</b> Indicates output response time selection</p>
Construction	<p><b>Transducer:</b> Ceramic/Epoxy composite</p> <p><b>Housing:</b> ABS</p> <p><b>Membrane Switch:</b> Polyester</p>
Environmental Rating	Leakproof design is rated IEC IP67; NEMA 6P
Operating Conditions	<b>Temperature:</b> -20 to +70 °C <b>Relative humidity:</b> 100%
Vibration and Mechanical Shock	All models meet Mil Std. 202F requirements. Method 201A (vibration: 10 to 60Hz max., double amplitude 0.06", maximum acceleration 10G). Also meets IEC 947-5-2 requirements: 30G 11 milliseconds duration, half sine wave.
Temperature Warmup Drift	Less than 1.0% of sensing distance upon power-up with Temperature Compensation enabled
Application Notes	Objects passing inside the specified minimum sensing distance (200 mm) may produce a false response
Certifications	

# S18U Series

## Barrel Ultrasonic Sensors



- Features minimal dead zone and can eliminate dead zone if used in retrosonic mode
- Compensates for temperature to provide greatest sensing accuracy
- Push-button and remote TEACH-mode programming with an external switch, computer or controller for added security and convenience



### S18U

Range	Connections	Output	Housing Configuration	Models
30 to 300 mm	2 m	0 to 10 V dc	Straight	S18UUA
	5-pin Euro QD			S18UUAQ
30 to 300 mm	2 m	4 to 20 mA	Straight	S18UIA
	5-pin Euro QD			S18UIAQ
30 to 300 mm	2 m	Bipolar NPN/PNP	Straight	S18UBA
	5-pin Euro QD			S18UBAQ

### S18U Right-Angle

Range	Connections	Output	Housing Configuration	Models
30 to 300 mm	2 m	0 to 10 V dc	Right-Angle	S18UJAR
	5-pin Euro QD			S18UJARQ
30 to 300 mm	2 m	4 to 20 mA	Right-Angle	S18UIAR
	5-pin Euro QD			S18UIARQ
30 to 300 mm	2 m	Bipolar NPN/PNP	Right-Angle	S18UBAR
	5-pin Euro QD			S18UBARQ

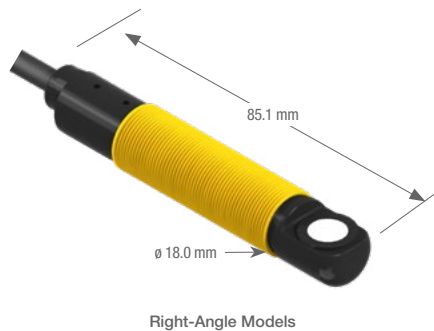

 Connection options: A model with a QD requires a mating cable.

For 9 m cable, add suffix W/30 to the 2 m model number (example, S18UUA W/30).



5-Pin

**Euro-Style with Shield**  
Straight connector models listed; for right-angle, add **RA** to the end of the model number (example, MQDEC2-506RA)

**MQDEC2-506**  
2 m (6.5')  
**MQDEC2-515**  
5 m (15')  
**MQDEC2-530**  
9 m (30')

Additional cordset information is available  
See page 758



SMB18A



SMB18FM

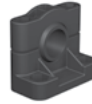

SMB18SF

Additional bracket information is available  
See page 723

Ultrasonic Wave Guides



Inside Diameter	Model
5.0 mm	UWG18-5.0
6.4 mm	UWG18-6.4

Additional wave guide information is available  
See page 959

S18U Specifications

Supply Voltage and Current	10 to 30 V dc (10% max. ripple); 65 mA max. (exclusive of load), 40 mA typical @ 25 V input	
Ultrasonic Frequency	300 kHz, rep. rate 2.5 milliseconds	
Supply Protection Circuitry	Protected against reverse polarity and transient voltages	
Output Protection	Protected against short circuit conditions	
Output Ratings	<p><b>Analog Voltage Output:</b> 2.5 kΩ min. load resistance Minimum supply for a full 10 V output is 12 V dc (for supply voltages between 10 and 12, V out max is at least V supply -2) <b>Analog Current Output:</b> 1 kΩ max @ 24 V input Max load resistance = (Vcc-4)/0.02 Ω</p> <p><b>Discrete:</b> 100 mA max. <b>OFF-state leakage current:</b> less than 5 μA <b>NPN saturation:</b> less than 200 mV @ 10 mA and less than 600 mV @ 100 mA <b>PNP saturation:</b> less than 1.2 V @ 10 mA and less than 1.6 V @ 100 mA</p>	
Output Configuration	<p><b>Analog:</b> 0 to 10 V dc or 4 to 20 mA, depending on model <b>Discrete: Bipolar:</b> One NPN (current sinking) and one PNP (current sourcing) output in each model. Solid-state switch conducts when target is sensed within sensing window.</p>	
Output Response Time	<b>Analog: 30 milliseconds:</b> Black wire at 0 to 2 V dc (or open)	<b>2.5 milliseconds:</b> Black wire at 5 to 30 V dc
Delay at Power-up	300 milliseconds	
Linearity	<b>Analog output models: 2.5 milliseconds response:</b> ± 1 mm	<b>30 milliseconds response:</b> ± 0.5 mm
Resolution	<b>Analog output models: 2.5 milliseconds response:</b> 1 mm	<b>30 milliseconds response:</b> 0.5 mm
Repeatability	<b>Discrete models:</b> 0.5 mm	
Temperature Effect	0.02% of distance/ °C	
Temperature Warmup Drift	Less than 1.7% of sensing distance upon power-up	
Minimum Window Size	5 mm	
Switching Hysteresis	<b>Discrete output models:</b> 0.7 mm	
Adjustments	<b>Sensing window limits:</b> TEACH-Mode programming of near and far window limits may be set using the push button or remotely using TEACH input	
Indicators	<p><b>Power/Signal Strength (Red/Green):</b> <b>Green:</b> Target is within sensing range <b>Red:</b> Target is outside sensing range <b>OFF:</b> Sensing power is OFF</p>	<p><b>Teach/Output Indicator (Yellow/Red):</b> <b>Yellow:</b> Target is within taught limits <b>OFF:</b> Target is outside taught window limits <b>Red:</b> Sensor is in TEACH mode</p>
Remote TEACH Input	<b>Impedance:</b> 12 kΩ	
Construction	<b>Threaded Barrel:</b> Thermoplastic polyester <b>Push Button:</b> Santoprene	<b>Push Button Housing:</b> ABS/PC <b>Lightpipes:</b> Acrylic
Environmental Rating	Leakproof design is rated IEC IP67; NEMA 6P	
Operating Conditions	<b>Temperature:</b> -20 to +60 °C	<b>Relative humidity:</b> 100%
Vibration and Mechanical Shock	All models meet Mil. Std. 202F requirements. method 201A (vibration: 10 to 60 Hz max., double amplitude 0.06", maximum acceleration 10G). Also meets IEC 947-5-2 requirements: 30G 11 milliseconds duration, half sine wave	
Application Notes	Objects passing inside the specified near limit may produce a false response	

Certifications



# T30UX Series

## Right-Angle, Long-Range Ultrasonic Sensors



- Built-in temperature compensation for high-accuracy across a wide range of ambient temperatures
- Resists harsh environments with rugged IP67 (NEMA 6) housing and fully encapsulated electronics
- Push-button and remote TEACH-mode programming with an external switch, computer or controller for added security and convenience

### T30UX

Range	Frequency	Connection	Response Time	Output	Models*
100 mm to 1 m	224 kHz	2 m 4-Pin Euro QD	45 ms	<b>Discrete:</b> NPN, PNP, NO, NC, Selectable	T30UXDA T30UXDAQ8
200 mm to 2 m	174 kHz	2 m 4-Pin Euro QD	92 ms	<b>Discrete:</b> NPN, PNP, NO, NC, Selectable	T30UXDB T30UXDBQ8
300 mm to 3 m	114 kHz	2 m 4-Pin Euro QD	135 ms	<b>Discrete:</b> NPN, PNP, NO, NC, Selectable	T30UXDC T30UXDCQ8
100 mm to 1 m	224 kHz	2 m 4-Pin Euro QD	Selectable 45 or 105 ms	<b>Analog:</b> 0 to 10 V dc	T30UXUA T30UXUAQ8
100 mm to 1 m	224 kHz	2 m 4-Pin Euro QD	Selectable 45 or 105 ms	<b>Analog:</b> 4 to 20 mA	T30UXIA T30UXIAQ8
200 mm to 2 m	174 kHz	2 m 4-Pin Euro QD	Selectable 92 or 222 ms	<b>Analog:</b> 0 to 10 V dc	T30UXUB T30UXUBQ8
200 mm to 2 m	174 kHz	2 m 4-Pin Euro QD	Selectable 92 or 222 ms	<b>Analog:</b> 4 to 20 mA	T30UXIB T30UXIBQ8
300 mm to 3 m	114 kHz	2 m 4-Pin Euro QD	Selectable 135 or 318 ms	<b>Analog:</b> 0 to 10 V dc	T30UXUC T30UXUCQ8
300 mm to 3 m	114 kHz	2 m 4-Pin Euro QD	Selectable 135 or 318 ms	<b>Analog:</b> 4 to 20 mA	T30UXIC T30UXICQ8

 Connection options: A model with a QD requires a mating cordset.

For 9 m cable, add suffix W/30 to the 2 m model number (example, T30UXDA W/30).

QD models: For a 4-pin 150 mm Euro-style PUR pigtail QD, add suffix QPMA the 2 m model number (example, T30UXDAQPMA).

\* Contact factory to request chemically resistant flange or fill-level control models.





4-Pin

**Euro-Style with Shield**  
Straight connector models listed; for right-angle, add **RA** to the end of the model number (example, MQDEC2-406RA)

- MQDEC2-406  
2 m (6.5')
- MQDEC2-415  
5 m (15')
- MQDEC2-430  
9 m (30')

Additional cordset information is available  
See page 758



SMB30A



SMB30FA..

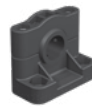



SMB1815SF

Additional bracket information is available  
See page 723



T30UX (Long-range) Models

T30UX Specifications

Supply Voltage and Current	10 to 30 V dc (10% max. ripple) at 40 mA, exclusive of load		
Supply Protection Circuitry	Protected against reverse polarity and transient voltages		
Output Configuration	<b>Discrete (switched) output models:</b> SPST solid-state switch. Configurable as NPN (sinking) or PNP (sourcing) via Mode push button. Normally Open (NO) or Normally Closed (NC) operation is also selectable via Mode push button. The default setting is PNP/NO. <b>Analog output models:</b> 0 to 10 V dc or 4 to 20 mA, depending on model		
Output Ratings	<b>Discrete output models:</b> 100 mA max. <b>OFF-state leakage current:</b> NPN: < 200 µA @ 30 V dc (see NOTE 1)                      PNP: < 10 µA @ 30 V dc <b>ON-state saturation voltage:</b> NPN: < 1.6 V @ 100 mA                                      PNP: < 3 V @ 100 mA <b>Analog output models:</b> <b>Analog Voltage Output:</b> 2.5 kΩ min. load resistance Minimum supply for a full 10 V output is 12 V dc (for supply voltages between 10 and 12, V out max. is at least V supply -2) <b>Analog Current Output:</b> 1 kΩ max. @ 24 V input; max. load resistance = (Vcc-4)/0.02Ω For current output (4-20 mA) models, ideal results are achieved when the total load resistance R = [(Vin - 4)/0.020]Ω. Example, at Vin = 24 V dc, R ≈ 1 kΩ (1 watt)		
Output Protection Circuitry	Protected against short circuit conditions		
Output Response Time	"A" suffix models: 45 milliseconds	"B" suffix models: 92 milliseconds	"C" suffix models: 135 milliseconds
Delay at Power-up	500 milliseconds		
Temperature Effect	0.02% of distance/ °C		
Linearity (analog models)	0.25% of distance		
Repeatability/Resolution	"A" suffix models: 0.1% of distance (0.5 mm min.) "B" suffix models: 0.1% of distance (1.0 mm min.) "C" suffix models: 0.1% of distance (1.5 mm min.)		
Sensing Hysteresis (discrete models)	"A" suffix models: 2 mm	"B" suffix models: 3 mm	"C" suffix models: 4 mm
Minimum Window Size	10 mm		
Adjustments	<b>Sensing window limits:</b> TEACH-Mode configuration of near and far window limits may be set using the push button or remotely via TEACH input <b>Discrete output models:</b> <b>Output Configuration:</b> NPN, PNP, Normally Open (NO), Normally Closed (NC) select <b>Advanced configuration options:</b> Push button enabled/disabled, temperature compensation enabled/disabled <b>Analog output models:</b> <b>Response speed selection:</b> Fast or Slow <b>Advanced configuration options:</b> Analog output slope, push button enabled/disabled, temperature compensation enabled/disabled		
Indicators	<b>Green Power LED ON:</b> Power ON, RUN mode <b>Red Signal LED:</b> Target signal strength <b>Amber Output LED:</b> Output enabled; sensor receiving a signal within the window limits <b>Amber Mode LED:</b> Currently selected mode		
Loss of Signal Indication (analog models)	0 to 10 V dc models: Analog output goes to 0 V 4 to 20 mA models: Analog output goes to 3.6 mA		
Construction	<b>Housing:</b> PBT polyester <b>Push buttons:</b> Polyester <b>Transducer:</b> Epoxy /ceramic composite		
Environmental Rating	Leakproof design, rated IEC IP67 (NEMA 6)		
Operating Conditions	<b>Temperature:</b> -40 to +70 °C <b>Relative humidity:</b> 95% at 50 °C non-condensing		
Vibration and Mechanical Shock	All models meet Mil. Std. 202F requirements. Method 201A (Vibration: 10 to 60Hz max., double amplitude 0.06", maximum acceleration 10G). Also meets IEC 947-5-2 requirements: 30G, 11 milliseconds duration, half sine wave.		
Application Notes	The temperature warmup drift upon power-up is less than 1% of the sensing distance		
Certifications	 		

NOTE: NPN < 200 µA for load impedance > 3 kΩ; for load current of 100 mA, leakage < 1% of load current

# T30U Series

## Right-Angle, Long-Range Ultrasonic Sensors



- Dual-discrete models for ON/OFF switching or pump-level control
- Resists harsh environments with rugged IP67 (NEMA 6) housing and fully encapsulated electronics
- Chemically resistant models with a Teflon® coating
- Push-button and remote TEACH-mode programming with an external switch, computer or controller for added security and convenience

### T30U, 12-24 V DC

Range	Frequency	Connection	Response Time	Discrete Output(s)	Analog Output	Models*
150 mm to 1 m	228 kHz	2 m	48 ms	NPN	4 to 20 mA	T30UINA
		5-pin Euro QD				T30UINAQ
		2 m		PNP		T30UIPA
		5-pin Euro QD				T30UIPAQ
300 mm to 2 m†	128 kHz	2 m	96 ms	NPN	4 to 20 mA	T30UINB
		5-pin Euro QD				T30UINBQ
		2 m		PNP		T30UIPB
		5-pin Euro QD				T30UIPBQ
150 mm to 1 m	228 kHz	2 m	48 ms	Dual NPN	None	T30UDNA
		5-pin Euro QD				T30UDNAQ
		2 m		Dual PNP		T30UDPA
		5-pin Euro QD				T30UDPAQ
300 mm to 2 m†	128 kHz	2 m	96 ms	Dual NPN	None	T30UDNB
		5-pin Euro QD				T30UDNBQ
		2 m		Dual PNP		T30UDPB
		5-pin Euro QD				T30UDPBQ
150 mm to 1 m	228 kHz	2 m	48 ms	Pump/Level Control	None	T30UHNA
		5-pin Euro QD				T30UHNAQ
300 mm to 2 m†	128 kHz	2 m	96 ms	Dual NPN	None	T30UHNB
		5-pin Euro QD				T30UHNBQ
150 mm to 1 m	228 kHz	2 m	48 ms	Pump/Level Control	None	T30UHPA
		5-pin Euro QD				T30UHPAQ
300 mm to 2 m†	128 kHz	2 m	96 ms	Dual PNP	None	T30UHPB
		5-pin Euro QD				T30UHPBQ

 Connection options: A model with a QD requires a mating cordset.

For 9 m cable, add suffix W/30 to the 2 m model number (example, T30UXDA W/30).

QD models: For a 4-pin 150 mm Euro-style PUR pigtail QD, add suffix QPMA the 2 m model number (example, T30UXDAQPMA).

\* Contact factory to request chemically resistant flange or fill-level control models.

† Teflon®-encapsulated models have a range of 300 mm - 1.5 m

T30U, 15-24 V DC

Range	Frequency	Connection	Response Time	Analog Output	Models NPN*	Models PNP*
150 mm to 1 m	228 kHz	2 m 5-pin Euro QD	48 ms	0 to 10 V dc	T30UUNA T30UUNAQ	T30UUPA T30UUPAQ
300 mm to 2 m†	128 kHz	2 m 5-pin Euro QD	96 ms	0 to 10 V dc	T30UUNB T30UUNBQ	T30UUPB T30UUPBQ

 Connection options: A model with a QD requires a mating cordset

For 9 m cable, add suffix W/30 to the 2 m model number (example, T30UUNA W/30).

\* For sensors with Teflon®-protected face and transducer (long-range models only), add suffix -CRFV to the model number (example, T30UUNB-CRFV).

† Teflon®-encapsulated models have a range of 300 mm - 1.5 m.

Teflon® is a registered trademark of Dupont™.

 **Euro-Style with Shield**  
Straight connector models listed; for right-angle, add RA to the end of the model number (example, MQDEC2-506RA)

**5-Pin**  
MQDEC2-506  
2 m (6.5')  
MQDEC2-515  
5 m (15')  
MQDEC2-530  
9 m (30')



SMB30A



SMB30FA..

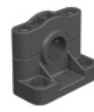

SMB1815SF

Additional cordset information is available  
See page 758

Additional bracket information is available  
See page 723



T30U Specifications

Supply Voltage and Current	<p><b>Current sourcing analog output models:</b> 12 to 24 V dc (10% max. ripple); 90 mA (exclusive of load)</p> <p><b>Voltage sourcing analog output models:</b> 15 to 24 V dc (10% max. ripple); 90 mA (exclusive of load)</p> <p><b>Dual-discrete output models:</b> 12 to 24 V dc (10% max. ripple); 90 mA (exclusive of load)</p>
Supply Protection Circuitry	Protected against reverse polarity and transient voltages
Ultrasonic Frequency	<p><b>Short Range (“A” suffix modes):</b> 228 kHz</p> <p><b>Long Range (“B” suffix models):</b> 128 kHz</p>
Output Protection	Protected against continuous overload and short-circuit; transient over-voltage; no false pulse on power-up
Output Configuration	<p><b>Discrete (switched) output:</b> Solid-state switch conducts when target is sensed within sensing window; choose NPN (current sinking) or PNP (current sourcing) models</p> <p><b>Analog output:</b> Choose 0 to 10 V dc sourcing or 4 to 20 mA sourcing output models; output slope may be selected using TEACH sequence</p>
Output Ratings	<p><b>Discrete (switched) output:</b> 100 mA max., total-both outputs</p> <p><b>OFF-state leakage current:</b> less than 10 µA</p> <p><b>ON-state saturation voltage:</b> less than 1 V at 10 mA and less than 1.5 V at 100 mA</p> <p><b>Analog Output:</b></p> <p><b>Voltage sourcing:</b> 0 to 10 V dc (at 1 kΩ min. resistance)</p> <p><b>Current sourcing:</b> 4 to 20 mA, 1 Ω to Rmax      <math>R_{max} = \frac{V_{supply} - 7V}{20 \text{ mA}}</math></p>
Output Response Time	<p><b>Discrete output:</b> “A” suffix models: 48 milliseconds      “B” suffix models: 96 milliseconds</p> <p><b>Analog output:</b> “A” suffix models: 48 milliseconds average, 16-millisecond update</p> <p>“B” suffix models: 96 milliseconds average, 32-millisecond update</p>
Sensing Performance (Specified using a 100 x 100 mm aluminum target at 25° C under fixed sensing conditions.)	<p><b>Analog sensing resolution or discrete output repeatability:</b> ±0.25% of measured distance</p> <p>“A” suffix models: .5 mm min      “B” suffix models: 1 mm min</p> <p><b>Analog linearity:</b> ±0.5% of full-scale span</p> <p><b>Min. window size:</b> 10 mm      <b>Hysteresis of discrete output:</b> 2.5 mm      <b>Temperature effect:</b> 0.2% of sensing distance per °C</p>
Indicators	<p><b>Four status LEDs: In RUN mode:</b></p> <p><b>Green ON Steady:</b> Power ON, RUN mode</p> <p><b>Green Flashing:</b> Discrete output is overloaded</p> <p><b>Red Flashing:</b> Relative received signal strength</p> <p><b>Yellow analog ON Steady:</b> Target is inside window limits</p> <p><b>Yellow discrete ON Steady:</b> Output conducting</p> <p><b>In Program mode:</b></p> <p><b>Green OFF:</b> PROGRAM mode</p> <p><b>Red Flashing:</b> Relative received signal strength</p> <p><b>Yellow ON Steady:</b> Ready for first window limit</p> <p><b>Yellow Flashing:</b> Ready for second limit</p> <p><b>Yellow OFF:</b> Not teaching this output</p>
Construction	Molded reinforced thermoplastic polyester housing
Environmental Rating	Leakproof design is rated IEC IP67; NEMA 6P
Operating Conditions	<p><b>Temperature:</b> -20 to +70 °C      <b>Relative humidity:</b> 100%</p>
Vibration and Mechanical Shock	All models meet Mil. Std. 202F requirements. Method 201A (Vibration: 10 to 60Hz max., double amplitude 0.06", maximum acceleration 10G). Also meets IEC 947-5-2 requirements: 30G, 11 milliseconds duration, half sine wave.
Certifications	

# M25U Series

## Stainless Steel Opposed Ultrasonic Sensors



- 316 stainless steel with no thread, gaps or seams to trap debris
- Constructed with FDA approved materials and rated to IP69K, IEC IP67 (NEMA 6) with fully encapsulated electronics
- Withstands high-temperature sprays of up to 80° C and 1500 psi occurring every few hours
- Features high-immunity to ambient electrical and sonic noise

### M25U

Range*	Frequency	Connection	Output	Response Time	Models
Normal Speed: 500 mm High Speed: 250 mm	140 kHz	4-pin Euro QD	—	—	<b>M25UEQ8</b> Emitter
		5-pin Euro QD	Bipolar NPN/PNP	<b>Normal Speed: 4.0 ms</b> <b>High Speed: 3.0 ms</b>	<b>M25URBQ8</b> Receiver

 Connection options: A model with a QD requires a mating cordset.

\* M25U receivers may be wired for either of two speed modes: Normal or High, depending on hookup. The Normal-Speed mode offers a sensing range of 500 mm. The Normal-Speed mode maximizes sensing energy, as is required in demanding environments. The High-Speed mode offers a sensing range of 250 mm. The High-Speed mode maximizes sensing response, as is needed in high-speed counting applications.



5-Pin

**Euro-Style with Shield**  
Straight connector models listed;  
for right-angle, add **RA** to the end  
of the model number (example,  
**MQDEC2-506RA**)

**MQDEC2-506**  
2 m (6.5')  
**MQDEC2-515**  
5 m (15')  
**MQDEC2-530**  
9 m (30')



5-Pin

**Euro-Style Washdown**  
Straight connector models only

**MQDCWD-506**  
2 m (6.5')  
**MQDCWD-530**  
9 m (30')

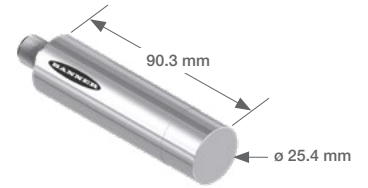

Additional cordset information is available  
See page 758



SMBM25A



SMBM25B

Additional bracket information is available  
See page 725

### M25U Specifications

<b>Sensing Range</b>	<b>Normal Speed:</b> 500 mm <b>High Speed:</b> 250 mm
<b>Ultrasonic Frequency</b>	140KHz
<b>Supply Voltage and Current</b>	<b>Emitter:</b> 10 to 30 V dc (10% max. ripple) at less than 85 mA <b>Receiver:</b> 10 to 30 V dc (10% max. ripple) at less than 38 mA (exclusive of load)
<b>Supply Protection Circuitry</b>	Protected against reverse polarity and transient voltages
<b>Receiver Output Configuration</b>	Bipolar (1 NPN & 1 PNP) solid-state output; Normally Open (output is activated when an object blocks the sensing beam)
<b>Output Rating</b>	100 mA (each output) with short circuit protection; see Note 1 <b>OFF-state leakage current:</b> NPN: < 200 µA sinking PNP: < 10 µA sourcing <b>ON-state saturation voltage:</b> NPN: < 1.6 V @ 100 mA PNP: < 3.0 V @ 100 mA
<b>Output Protection Circuitry</b>	Protected against short circuit conditions
<b>Output Response Time</b>	<b>Normal Speed:</b> 4.0 milliseconds <b>High Speed:</b> 3.0 milliseconds
<b>Repeatability</b>	1 millisecond
<b>Delay at Power-up</b>	< 250 milliseconds
<b>Delay for Switching Between Normal and High Speed</b>	20 milliseconds
<b>Indicators</b>	<b>Green Power LED:</b> indicates Power ON <b>Amber Output LED:</b> indicates output activated
<b>Construction</b>	<b>Housing:</b> 316 Stainless Steel <b>LED window:</b> Polysulphone
<b>Environmental Rating</b>	Leakproof design, rated IEC IP67 (NEMA 6), IP69K
<b>Operating Conditions</b>	<b>Temperature:</b> -20 to +70 °C <b>Max. Relative Humidity:</b> 95% at 50° C non-condensing
<b>Vibration and Mechanical Shock</b>	All models meet Mil. Std. 202F requirements method 201A (vibration: 10 to 60 Hz max. amplitude 0.06", max. acceleration 10G). Also meets IEC 947-5-2; 30G 11 ms duration.
<b>Notes</b>	1. NPN < 200 µA for load impedance > 3 KΩ; for load current of 100 mA, leakage < 1% of load current 2. When mounting the M25U, care should be taken to acoustically isolate the emitter and receiver to eliminate sound energy coupling between the sensor pair. This is best accomplished with elastomeric materials between the sensor and rigid mounting brackets.

Certifications



# T18U Series

## Opposed Dual-Range Ultrasonic Sensors



- T-style right-angle sensor package with an 18 mm threaded mounting hub, for versatile mounting
- Response time of 1 millisecond and ranges up to 600 mm suitable for high-speed applications such as counting
- Offers high immunity to electrical and acoustic noise
- Includes signal strength indicator to make alignment easy
- Ideal for small object and clear object detection

### T18U

Range <sup>†</sup>	Connection	Response Time	Models NPN*	Models PNP*
NORMAL resolution: 600 mm HIGH resolution: 300 mm	2 m 4-pin Euro QD	NORMAL resolution: 2 ms HIGH resolution: 1 ms	T186UE Emitter T186UEQ Emitter	
NORMAL resolution: 600 mm HIGH resolution: 300 mm	2 m 4-pin Euro QD	NORMAL resolution: 2 ms HIGH resolution: 1 ms	T18VN6UR T18VN6URQ	T18VP6UR T18VP6URQ

 Connection options: A model with a QD requires a mating cordset.

For 9 m cable, add suffix W/30 to the 2 m model number (example, T18VN6UR W/30).

<sup>†</sup> Receivers may be wired for either resolutions: Normal or High.

\* Sensor pair requires one emitter and one receiver.



**Euro-Style**  
 Straight connector models listed; for right-angle, add **RA** to the end of the model number (example, **MQDC-406RA**)

Additional cordset information is available  
 See page 758



Additional bracket information is available  
 See page 723



**Ultrasonic Wave Guides**

Inside Diameter	Model
5.0 mm	<b>UWG18-5.0</b>
6.4 mm	<b>UWG18-6.4</b>

Additional wave guide information is available  
 See page 959

**T18U Specifications**

<b>Sensing Range (no minimum range)</b>	<b>NORMAL resolution mode:</b> to 600 mm <b>HIGH resolution mode:</b> to 300 mm
<b>Supply Voltage and Current</b>	12 to 30 V dc, 10% max. ac ripple 50 mA (emitters); 35 mA (receivers), exclusive of output load
<b>Ultrasonic Frequency</b>	230 kHz
<b>Minimum spacing (adjacent pairs)</b>	50 mm for emitter-to-receiver separations of up to 150 mm Add 10 mm of adjacent-pair spacing for every 100 mm of emitter-to-receiver spacing beyond 150 mm
<b>Receiver Output Configuration</b>	<b>T18VN models:</b> NPN sinking, NO and NC (complementary) <b>T18VP models:</b> PNP sourcing, NO and NC (complementary)
<b>Receiver Output Rating</b>	150 mA max. each output at 25 °C, derated to 100 mA at 70 °C (derate ≈ 1 mA per °C) Both outputs may be used simultaneously. <b>ON-state saturation voltage:</b> less than 1.5 V at 10 mA; less than 2.0 V at 150 mA <b>OFF-state leakage current:</b> less than 1 µA at 30 V dc <b>Output protection:</b> Overload and short-circuit protected. <b>No false pulse upon receiver power-up:</b> false pulse protection causes a 100 millisecond delay upon power-up.
<b>Output Response Time</b>	<b>NORMAL resolution mode:</b> 2 milliseconds ON/OFF <b>HIGH resolution mode:</b> 1 millisecond ON/OFF
<b>Rep Rate</b>	<b>NORMAL resolution mode:</b> 125 Hz max. <b>HIGH resolution mode:</b> 200 Hz max.
<b>Mechanical Sensing Repeatability at 300 mm range</b>	<b>NORMAL resolution mode:</b> less than 2 mm <b>HIGH resolution mode:</b> less than 1 mm
<b>Beam Angle (-3dB full angle)</b>	15 ± 2°
<b>Indicators</b>	Emitters have a green LED for dc power ON.      Receivers have two LEDs, one yellow and one green <b>Solid Green:</b> power ON <b>Flashing Green:</b> output overloaded <b>Yellow:</b> sonic signal received (flash rate is proportional to received signal strength; flash is from full to half intensity) See data sheet for detailed information
<b>Construction</b>	T-style yellow PBT polyester housing with black PBT polyester back cover. Transducer housing is threaded M18 x 1. Mating jam nut is supplied for mounting. Acoustic face is epoxy reinforced. Circuitry is epoxy-encapsulated.
<b>Environmental Rating</b>	IEC IP67; NEMA 6P
<b>Operating Temperature</b>	-40 to +70 °C
<b>Vibration and Mechanical Shock</b>	All models meet Mil.Std 202F requirements method 201A (Vibration: frequency 10 to 60 Hz, max., and double amplitude 0.06", maximum acceleration 10G) and method 213B conditions H&I (Shock: 75G with unit operation; 100G for non-operation). Also meets IEC 947-5-2 requirements: 30G, 11 milliseconds duration, half sine wave.

Certifications





# Q45U Series

## Versatile Ultrasonic Sensors



- The Q45U accepts programming storage cards for fast, easy sensing parameter changes with ranges up to 3 m
- Bipolar discrete models have switches for ON/OFF presence detection and HIGH/LOW level control
- In ON/OFF mode, bipolar discrete models detect when the target is within the set range or when it is outside the range
- In HIGH/LOW mode, bipolar discrete models detect when the target is outside the configured range, for fill level control, web tensioning control and similar applications
- Response time is programmed with switches in discrete models and with a potentiometer in analog models
- Push-button and remote TEACH-mode programming with an external switch, computer or controller for added security and convenience



### Q45U Discrete Output, 12-24 V DC

Range	Temperature Compensation	Connection	Output Type	Response Time	Models
100 mm to 1.4 m	No	2 m	Bipolar NPN/PNP	Programmable for 20, 40, 160 or 640 ms	Q45UBB63DA Q45UBB63DAQ Q45UBB63DAQ6
		5-pin Mini QD 5-pin Euro QD			
100 mm to 1.4 m	Yes	2 m	Bipolar NPN/PNP	Programmable for 20, 40, 160 or 640 ms	Q45UBB63DAC Q45UBB63DACQ Q45UBB63DACQ6
		5-pin Mini QD 5-pin Euro QD			
250 mm to 3 m†	Yes	2 m	Bipolar NPN/PNP	Programmable for 40, 80, 320 or 1280 ms	Q45UBB63BC Q45UBB63BCQ Q45UBB63BCQ6
		5-pin Mini QD 5-pin Euro QD			



### Q45U Analog Output, 15-24 V DC

Range	Temperature Compensation	Connection	Output Type	Response Time	Models
100 mm to 1.4 m	Yes	2 m	Selectable 0 to 10 V dc or 4 to 20 mA	Adjustable from 40 to 1280 ms	Q45ULIU64ACR Q45ULIU64ACRQ Q45ULIU64ACRQ6
		5-pin Mini QD 5-pin Euro QD			
250 mm to 3 m†	Yes	2 m	Selectable 0 to 10 V dc or 4 to 20 mA	Adjustable from 80 to 2560 ms	Q45ULIU64BCR Q45ULIU64BCRQ Q45ULIU64BCRQ6
		5-pin Mini QD 5-pin Euro QD			

Connection options: A model with a QD requires a mating cordset.

For 9 m cable, add suffix W/30 to the 2 m model number (example, Q45UBB63DA W/30).

† The far limit may be extended as far as 3.9 m for good acoustical targets—hard surfaces with area greater than 100 cm<sup>2</sup>.



5-Pin

**Euro-Style with Shield**  
Straight connector models listed; for right-angle, add **RA** to the end of the model number (example, **MQDEC2-506RA**)

- MQDEC2-506**  
2 m (6.5')
- MQDEC2-515**  
5 m (15')
- MQDEC2-530**  
9 m (30')



5-Pin

**Mini-Style with Shield**  
Straight connector models only

- MBCC2-506**  
2 m (6.5')
- MBCC2-515**  
5 m (15')
- MBCC2-530**  
9 m (30')



SMB30A



SMB30MM



SMB30SC

Additional cordset information is available  
See page 758

Additional bracket information is available  
See page 722

Q45U Specifications

<b>Sensing Range</b>	<b>"A" suffix:</b> Near limit: 100 mm min. (239 kHz) <b>"B" suffix:</b> Near limit: 250 mm min. (128 kHz) <b>"A" suffix:</b> Far limit: 1.4 m max. (239 kHz) <b>"B" suffix:</b> Far limit: 3.0 m max. (128 kHz) NOTE: The far limit may be extended on long range units, as far as 3.9 m for good acoustical targets (hard surfaces with area greater than 100 cm <sup>2</sup> )		
<b>Supply Voltage and Current</b>	<b>Discrete:</b> 12 to 24 V dc (10% max. ripple); 100 mA (exclusive of load) <b>Analog:</b> 15 to 24 V dc (10% max. ripple); 100 mA (exclusive of load)		
<b>Supply Protection Circuitry</b>	Protected against reverse polarity and transient voltages		
<b>Output Protection Circuitry</b>	Protected against false pulse on power-up and continuous overload or short-circuit of outputs		
<b>Output Configuration</b>	<b>Discrete: Bipolar:</b> One current sourcing (PNP) and one current sinking (NPN) open collector transistor <b>Analog:</b> One voltage sourcing and one current sourcing; one or the other output is enabled by internal programming switch #2		
<b>Output Ratings</b>	<b>Discrete:</b> 150 mA max. (each) <b>OFF-state leakage current:</b> less than 25 $\mu$ A at 24 V dc <b>ON-state saturation voltage:</b> less than 1.5 V at 10 mA; less than 2.0 V at 150 mA <b>Analog:</b> <b>Voltage sourcing:</b> 0 to 10 V dc, 10 mA max. <b>Current sourcing:</b> 4 to 20 mA, 1 to 500 $\Omega$ impedance		
<b>Performance Specifications</b>	<b>"A" suffix</b>	<b>"B" suffix</b>	
<b>Analog resolution or discrete repeatability:</b>	$\pm$ 0.1% of sensing distance ( $\pm$ 0.25 mm min.)	$\pm$ 0.1% of sensing distance ( $\pm$ 0.5 mm min.)	
<b>Analog Linearity:</b>	1% of full scale	1% of full scale	
<b>Temperature effect:</b>	0.05% of sensing distance/ $^{\circ}$ C with temp. comp. 0.2% of sensing distance/ $^{\circ}$ C without temp. comp.	0.05% of sensing distance/ $^{\circ}$ C	
<b>Min. window size:</b>	10 mm	25 mm	
<b>Hysteresis (discrete output):</b>	5 mm	10 mm	
<b>Adjustments</b>	The following may be selected by a 4-position DIP switch. <b>Discrete:</b> <b>Switch 1:</b> Output normally open/normally closed (pump in/pump out) <b>Switch 2:</b> High/Low level control mode or on/off presence sensing mode <b>Switch 3 &amp; 4:</b> Response speed selection (digital filter) <b>Analog:</b> <b>Switch 1:</b> Output slope positive or output slope negative <b>Switch 2:</b> Current output mode or voltage output mode <b>Switch 3:</b> Loss of echo min/max mode or loss of echo Hold Mode <b>Switch 4:</b> Loss of echo min/max default output value		
<b>Indicators</b>	<b>Discrete: Three status LEDs:</b> <b>Solid Green:</b> power ON <b>Flashing Green:</b> output overloaded <b>Yellow:</b> outputs are conducting (Yellow LED also indicates programming status during setup mode) <b>Red:</b> indicates relative strength of received echo <b>Analog: Three status LEDs:</b> <b>Green:</b> power ON <b>Flashing Green:</b> current output fault (4-20 mA current path to ground is open) <b>Yellow:</b> target is sensed within the window limits (Yellow LED also indicates programming status during setup mode) <b>Red flashing:</b> indicates relative strength of received echo 5-segment moving dot LED indicates the position of the target within the sensing window. See data sheet for detailed information.		
<b>Construction</b>	Molded PBT polyester thermoplastic polyester housing, o-ring sealed transparent acrylic top cover, and stainless steel hardware. Q45U sensors are designed to withstand 1200 psi washdown. The base of cabled models has a 1/2"-14NPS internal conduit thread.		
<b>Environmental Rating</b>	Leakproof design is rated IEC IP67; NEMA 6P		
<b>Operating Conditions</b>	<b>Temperature:</b> -25 to +70 $^{\circ}$ C <b>Relative humidity:</b> 100%		
<b>Vibration and Mechanical Shock</b>	All models meet Mil. Std. 202F requirements. Method 201A (Vibration: 10 to 60Hz max., double amplitude 0.06", maximum acceleration 10G). Method 213B conditions H & I (Shock: 75G with unit operating; 100G for non-operation). Also meets IEC 947-5-2 requirements: 30G, 11 milliseconds duration, half sine wave.		
<b>Application Notes</b>	<b>"A" suffix: Min. target size:</b> 10 x 10 mm aluminum plate at 500 mm <span style="float: right;">35 x 35 mm aluminum plate at 1.4 m</span> <b>"B" suffix: Min. target size:</b> 50 x 50 mm aluminum plate at 3 m <b>Discrete:</b> Enable/Disable; Connect yellow wire to +5 to 24 V dc to enable sensor and 0 to +2 V dc to disable sensor. When the sensor is disabled, the last output state is held until the sensor is re-enabled. The wire must be held to the appropriate voltage for at least 40 milliseconds for the sensor to enable or disable.		
<b>Certifications</b>			



# Q45UR Series

## Remote Transducer Ultrasonic Sensors





- Q45 housing with an available plastic or a stainless steel 18 mm threaded barrel sensing head or an ultra-compact plastic Flat-Pak sensing head
- The Q45UR has sensing ranges up to 250 mm
- Resolution/repeatability +/- 0.2% of sensing distance
- Analog models feature a selectable positive or negative output slope
- Environmental rating is IEC IP65 and NEMA 4
- Push-button and remote TEACH-mode programming with an external switch, computer or controller for added security and convenience

### Q45UR Discrete Output, 12-24 V DC

Sensor Range	Controller Connection	Controller Output	Kit Models	Kit Includes: Controller & Sensor	
50 to 250 mm	2 m	Bipolar NPN/PNP	Q45UR3BA63CK	 <b>M18C2.0</b> Stainless Steel Barrel	
	5-pin Mini QD		Q45UR3BA63CQK		Q45UR3BA63CQ
	5-pin Euro QD		Q45UR3BA63CQ6K		Q45UR3BA63CQ6
50 to 250 mm	2 m	Bipolar NPN/PNP	Q45UR3BA63CKQ	 <b>Q13C2.0</b> Flat-Pak	
	5-pin Mini QD		Q45UR3BA63CQKQ		Q45UR3BA63CQ
	5-pin Euro QD		Q45UR3BA63CQ6KQ		Q45UR3BA63CQ6
50 to 250 mm	2 m	Bipolar NPN/PNP	Q45UR3BA63CKS	 <b>S18C2.0</b> Molded Barrel	
	5-pin Mini QD		Q45UR3BA63CQKS		Q45UR3BA63CQ
	5-pin Euro QD		Q45UR3BA63CQ6KS		Q45UR3BA63CQ6



### Q45UR Analog Output, 15-24 V DC

Sensor Range	Controller Cable	Controller Output	Kit Models	Kit Includes: Controller & Sensor	
50 to 250 mm	2 m		Q45UR3LIU64CK	 <b>M18C2.0</b> Stainless Steel Barrel	
	5-pin Mini QD		Q45UR3LIU64CQK		Q45UR3LIU64CQ
	5-pin Euro QD		Q45UR3LIU64CQ6K		Q45UR3LIU64CQ6
50 to 250 mm	2 m	Selectable 0 to 10 V dc or 4 to 20 mA	Q45UR3LIU64CKQ	 <b>Q13C2.0</b> Flat-Pak	
	5-pin Mini QD		Q45UR3LIU64CQKQ		Q45UR3LIU64CQ
	5-pin Euro QD		Q45UR3LIU64CQ6KQ		Q45UR3LIU64CQ6
50 to 250 mm	2 m		Q45UR3LIU64CKS	 <b>S18C2.0</b> Molded Barrel	
	5-pin Mini QD		Q45UR3LIU64CQKS		Q45UR3LIU64CQ
	5-pin Euro QD		Q45UR3LIU64CQ6KS		Q45UR3LIU64CQ6

 Connection options: A model with a QD requires a mating cordset.

For 9 m cable, add suffix W/30 to the 2 m model number (example, Q45UR3BA63CK W/30).



**Euro-Style with Shield**  
Straight connector models listed; for right-angle, add **RA** to the end of the model number (example, **MQDEC2-506RA**)

**5-Pin**  
**MQDEC2-506**  
2 m (6.5')  
**MQDEC2-515**  
5 m (15')  
**MQDEC2-530**  
9 m (30')



**Mini-Style with Shield**  
Straight connector models only

**5-Pin**  
**MBCC2-506**  
2 m (6.5')  
**MBCC2-512**  
4 m (12')  
**MBCC2-530**  
9 m (30')



SMB30A



SMB30MM



SMB30SC

Additional bracket information is available  
See page 722

Q45UR High-Gain Controllers

Version	Model
Discrete	63060 <b>Q45UR3BA63CQ6-63060</b>
Analog	63667 <b>Q45UR3LIU64CQ6-63667</b>

NOTE: Special High-Gain controllers are available for small object detection.  
Contact factory for more information.

Q45UR Remote Sensors Specifications

<b>Supply Voltage and Current</b>	<b>Discrete:</b> 12 to 24 V dc (10% max. ripple); 100 mA (exclusive of load)	<b>Analog:</b> 15 to 24 V dc (10% max. ripple); 100 mA (exclusive of load)
<b>Ultrasonic Frequency</b>	400 kHz	
<b>Supply Protection Circuitry</b>	Protected against reverse polarity and transient voltages	
<b>Output Protection Circuitry</b>	Both outputs are protected against continuous overload and short circuit	
<b>Output Rating</b>	<b>Discrete:</b> 150 mA max. (each output) <b>OFF-state leakage current:</b> less than 25 µA at 24 V dc <b>ON-state saturation voltage:</b> less than 1.5 V at 10 mA;	<b>Analog:</b> <b>Voltage sourcing:</b> 0 to 10 V dc, 10 mA max. <b>Current sourcing:</b> 4 to 20 mA, 1 to 500 Ω impedance
<b>Output Configuration</b>	<b>Discrete: Bipolar:</b>  One current sourcing (PNP) and one current sinking (NPN) open collector transistor	<b>Analog:</b> One voltage sourcing and one current sourcing; one or the other output is enabled by internal programming switch #2
<b>Performance Specifications</b>	<b>Discrete:</b> <b>Response Speed:</b> 40 or 160 ms (switch selectable) <b>Repeatability*:</b> ±0.2% of measured distance <b>Temperature stability:</b> ±0.03% of the window limit positions per °C from 0 to 50 °C, (±0.05% per °C over remainder of operating temperature range) <b>Sensing window width:</b> 5 to 200 mm, when independent near and far limits are taught; 1, 2, 3, or 4 mm (switch selectable), when a sensing distance set point is taught <b>Hysteresis:</b> 0.5 mm <b>Ultrasonic beam angle:</b> ±3.5°	<b>Analog:</b> <b>Response Speed:</b> 10 to 320 ms (2 to 64 cycles) selectable <b>Resolution*:</b> 0.2% of sensing distance at 320 ms response, 0.4% of sensing distance at 10 ms response <b>Linearity*:</b> 1% of full scale <b>Temperature stability:</b> ±0.03% of sensing distance per °C from 0 to 50 °C, (±0.05% per °C over remainder of operating temperature) <b>Ultrasonic beam angle:</b> ±3.5°
	* Repeatability and analog resolution and linearity are specified using a 50 x 50 mm aluminum plate at 22° C under fixed sensing conditions (Analog: using the 4 to 20 mA output @ 15 V dc)	
<b>Adjustments</b>	<b>Discrete:</b> The following may be selected by a 4-position DIP switch <b>Switch 1:</b> Output normally open (output is energized when target is within sensing window limits), or normally closed (output is energized when target is outside sensing window limits) <b>Switches 2 &amp; 3:</b> Sensing window size (1, 2, 3 or 4 mm) <b>Switch 4:</b> Response speed selection (40 or 160 milliseconds)	<b>Analog:</b> Push-button TEACH-mode programming of window limits. The following may be selected by a 4-position DIP switch located on top of the controller, beneath a transparent o-ring sealed acrylic cover and beneath the black inner cover. <b>Switch 1:</b> Output slope: output value increases or decreases with distance <b>Switch 2:</b> Output mode: current output or voltage output <b>Switches 3 &amp; 4:</b> Response to loss of echo <b>Response Speed Adjustment:</b> Single-turn potentiometer selects six response values from 10 to 320 milliseconds
<b>Indicators</b>	<b>Discrete: Three status LEDs:</b> <b>Green:</b> Power ON <b>Yellow:</b> Output are conducting (Yellow also indicates programming status during setup) <b>Red:</b> Relative strength of received echo  5-segment moving dot LED indicates the position of the target within the sensing window	<b>Analog: Three status LEDs:</b> <b>Solid Green:</b> Power ON <b>Flashing Green:</b> current output fault (4-20 mA current path to ground is open) <b>Yellow:</b> Target is sensed within the window limits (Yellow LED also indicates programming status during setup mode) <b>Red:</b> Relative strength of received echo  5-segment moving dot LED indicates the position of the target within the sensing window (See data sheet for detailed information)
<b>Construction</b>	<b>Controller:</b> Molded thermoplastic polyester housing, o-ring sealed transparent acrylic top cover, and stainless steel hardware <b>Sensors: M18C2.0:</b> Stainless steel M18 threaded barrel housing and jam nuts, polyetherimide front cover, ceramic transducer, polyurethane rear cover <b>S18C2.0:</b> Thermoplastic polyester S18 threaded barrel housing and jam nuts, polyetherimide front cover, ceramic transducer, polyurethane rear cover <b>Q13C2.0:</b> Molded 30% glass reinforced thermoplastic polyester housing, ceramic transducer, fully epoxy-encapsulated	
<b>Environmental Rating</b>	<b>Controller:</b> IEC IP67; NEMA 6P	<b>Sensor:</b> IEC IP65; NEMA 4
<b>Operating Conditions</b>	<b>Controller and sensor:</b> -25 to +70 °C	<b>Relative humidity:</b> 85% (non-condensing)
<b>Vibration and Mechanical Shock</b>	All models meet Mil. Std. 202F requirements. Method 201A Vibration: 10 to 60Hz max., double amplitude 0.06" (maximum acceleration 10G). Method 213B conditions H & I (Shock: 75G with unit operating; 100G for non-operation). Also meets IEC 947-5-2 requirements: 30G, 11 milliseconds duration, half sine wave.	
<b>Certifications</b>	CE	

# QS18U Series

## Right-Angle Ultrasonic Sensors



- Senses clear and transparent materials, as well as color variations, including clear web material, clear or shiny bottles, highly reflective surfaces and liquid or dry bulk materials inside cramped locations
- Sensing range up to 500 mm.
- Features a universal housing with an 18 mm threaded lens or side mount
- Available in encapsulated IP68 models rated for a range of harsh conditions
- Push-button and remote TEACH-mode programming with an external switch, computer or controller for added security and convenience

### QS18U

Range	Connection	TEACH Options	Models NPN	Models PNP
50 to 500 mm	2 m	Integral push button and remote TEACH (IP67; NEMA 6P)	QS18UNA	QS18UPA
	4-pin Euro QD		QS18UNAQ8	QS18UPAQ8
50 to 500 mm	2 m	Remote TEACH (epoxy-encapsulated, IP68; NEMA 6P)	QS18UNAE*	QS18UPAE*
	4-pin Euro QD		QS18UNAEQ8*	QS18UPAEQ8*

\* Models are epoxy-encapsulated, IP68; NEMA 6P with remote TEACH programming

 Connection options: A model with a QD requires a mating cordset.

For 9 m cable, add suffix W/30 to the 2 m model number (example, QS18UNA W/30).

QD models:

- For 4-pin integral Euro-style QD, add suffix Q8 (example, QS18UNAQ8).
- For 4-pin integral Pico-style QD, add suffix Q7 (example, QS18UNAQ7).
- For 4-pin 150 mm Euro-style pigtail, add suffix Q5 (example, QS18UNAQ5).
- For 4-pin 150 mm Pico-style pigtail, add suffix Q (example, QS18UNAQ).



**Euro-Style with Shield**  
Straight connector models listed; for right-angle, add **RA** to the end of the model number (example, **MQDEC2-406RA**)

4-Pin
<b>MQDEC2-406</b> 2 m (6.5')
<b>MQDEC2-415</b> 5 m (15')
<b>MQDEC2-430</b> 9 m (30')



**Pico-Style with Shield**

Straight 4-Pin	Right-Angle 4-Pin
<b>PKG4S-2</b> 2 m (6.5')	<b>PKW4ZS-2</b> 2 m (6.5')

Additional cordset information is available  
See page 758





**SMB18A**      **SMB18FA..**      **SMB1815SF**

Additional bracket information is available  
See page 722

**Ultrasonic Wave Guides**



Inside Diameter	Model
5.0 mm	<b>UWG18-5.0</b>
6.4 mm	<b>UWG18-6.4</b>

Additional wave guide information is available  
See page 959



QS18U Specifications

<b>Sensing Range</b>	50 to 500 mm	
<b>Supply Voltage and Current</b>	12 to 30 V dc (10% max. ripple); 25 mA max. (exclusive of load)	
<b>Ultrasonic Frequency</b>	300 kHz, rep. rate 7.5 milliseconds	
<b>Supply Protection Circuitry</b>	Protected against reverse polarity and transient voltages	
<b>Output Protection</b>	Protected against short circuit conditions	
<b>Delay at Power-Up</b>	300 milliseconds	
<b>Output Configurations</b>	Solid-state switch conducts when target is sensed within sensing window; one NPN (current sinking) or one PNP (current sourcing), depending on model	
<b>Temperature Effect</b>	<b>Non-encapsulated models:</b> ± 0.05% per °C from -20 to +50 °C, ± 0.1% per °C from +50 to +60 °C <b>Encapsulated models:</b> ± 0.05% per °C from 0° to +60° C, ± 0.1% per °C from -20° to 0° C	
<b>Repeatability</b>	0.7 mm	
<b>Hysteresis</b>	1.4 mm	
<b>Output Ratings</b>	100 mA max. (see Application Note 1) <b>OFF-state leakage current:</b> less than 10 µA (sourcing); less than 200 µA (sinking); See Application Note 2 <b>NPN ON-state saturation voltage:</b> less than 1.6 V @ 100 mA <b>PNP ON-state saturation voltage:</b> less than 3.0 V @ 100 mA	
<b>Output Response Time</b>	15 milliseconds	
<b>Minimum Window Size</b>	5 mm	
<b>Adjustments</b>	<b>Sensing window limits:</b> TEACH-Mode programming of near and far window limits may be set using the push button or remotely using TEACH input	
<b>Indicators</b>	<b>Range Indicator (Red/Green)</b> <b>Green:</b> Target is within sensing range <b>Red:</b> Target is outside sensing range <b>OFF:</b> Sensing power is OFF	<b>Teach/Output Indicator (Yellow/Red)</b> <b>Yellow:</b> Target is within taught limits <b>OFF:</b> Target is outside taught window limits <b>Red:</b> Sensor is in TEACH mode
<b>Construction</b>	<b>Housing:</b> ABS <b>Push Button:</b> TPE	<b>Push Button Housing:</b> ABS <b>Lightpipes:</b> Polycarbonate
<b>Environmental Rating</b>	Leakproof design, rated IEC IP67 or IP68; NEMA 6P, depending on model; UL type 1	
<b>Operating Conditions</b>	<b>Temperature:</b> -20 to +60 °C	<b>Relative humidity:</b> 100% (non-condensing)
<b>Vibration and Mechanical Shock</b>	All models meet Mil. Std. 202F requirements method 201A (vibration: 10 to 60 Hz max., double amplitude 0.06", maximum acceleration 10G). Also meets IEC 947-5-2 requirements: 30G 11 milliseconds duration, half sine wave.	
<b>Temperature Warmup Drift</b>	See data sheet	
<b>Application Notes</b>	1. If supply voltage is > 24 V dc, derate maximum output current 5 mA/ °C above 50 °C. 2. NPN OFF-state leakage current is < 200 µA for load resistances > 3 kΩ or optically isolated loads. For load current of 100 mA, leakage is < 1% of load current. 3. Objects passing inside the specified near limit may produce a false response.	
<b>Certifications</b>		



# K50U Series

## Ultrasonic Sensor for Wireless Level and Tank Monitoring



- Three meter sensing range with a 300 mm dead zone
- Provides a distance measurement from the target to the sensor
- Built-in temperature compensation
- Rugged design for demanding sensing environments; rated IEC IP67, NEMA 6P
- Functions as a Modbus slave device using RS-485

### K50U

Range and Frequency	Supply Voltage	I/O	Models
Range: 300 mm to 3 m Frequency: 114 kHz	3.6 to 5.5 V dc	Distance to target using a 1-wire serial interface	K50UX1RA
Range: 300 mm to 3 m Frequency: 114 kHz	3.6 to 5.5 V dc or 10 to 30 V dc	Distance to target using Modbus RS-485	K50UX2RA





5-Pin

**Euro-Style**  
Double-ended, straight male to female

- DEE2R-51D**  
0.31 m (1')
- DEE2R-53D**  
0.91 m (3')
- DEE2R-58D**  
2.44 m (8')

Additional cordset information is available  
See page 758



**BWA-BK-006**

Mounts both the K50U Ultrasonic sensor and a Wireless Q45 Node



Ø 50.0 mm

1/4" NPT connection

59.5 mm



### K50U Specifications

<b>Supply Voltage and Current</b>	3.6 to 5.5 V dc or 10 to 30 V dc
<b>Current</b>	Active comms: 11.3 mA at 30 V dc
<b>Indicators</b>	Two LEDs
<b>Performance</b>	<b>Sensing range:</b> 300 mm to 3 m (11.8 in to 118 in) <b>Ultrasonic frequency:</b> 114 kHz <b>Temperature effect:</b> 0.02% of distance/°C <b>Resolution:</b> 0.1% of distance (1.5 mm minimum)
<b>Discrete Inputs</b>	300 milliseconds
<b>Output Configurations</b>	One Sinking <b>Rating:</b> 3 mA max current at 30 V dc <b>ON Condition:</b> Less than 0.7 V <b>OFF Condition:</b> Greater than 2 V or open
<b>Communication Protocol</b>	Modbus RTU
<b>Communication Hardware</b>	RS-485 Serial <b>Baud Rates:</b> 9.6k, 19.2k (default), or 38.4k <b>Data Format:</b> 8 data bits, No parity (default), even parity, or odd parity 1 stop bit Do not use a termination resistor
<b>Communications Line</b>	<b>Level Receive ON:</b> Greater than 2 V <b>Level Receive OFF:</b> Less than 0.7 V <b>Level Transmit ON:</b> 2.7 to 3 V <b>Level Transmit OFF:</b> 0 V (pulldown resistor of 10 kOhm)
<b>Construction</b>	<b>Housing:</b> PBT polyester <b>Transducer:</b> Epoxy/ceramic composite
<b>Environmental Rating</b>	Leakproof design, rated IEC IP67 (NEMA 6)
<b>Operating Conditions</b>	<b>Temperature:</b> -40 to +70 °C <b>Relative humidity:</b> 95% at +50 °C maximum relative humidity (non-condensing)
<b>Vibration and Mechanical Shock</b>	All models meet Mil Std. 202F requirements. Method 201A (vibration: 10 Hz to 60 Hz max., double amplitude 0.06 inch, maximum acceleration 10G). Also meets IEC 947-5-2 requirements: 30G 11 ms duration, half sine wave
<b>Certifications</b>	



## Radar

Radar sensors use Frequency Modulated Continuous Wave (FMCW) radar to reliably detect moving or stationary targets, including cars, trains, trucks and cargo in rain, snow, high and low temperatures and wind.

Series	Description	Max. Sensing Range	Beam Angle	Outputs	Dimensions H x W x D	Power Supply
	<b>Q120R</b> FMCW Radar dual-zone, narrow-beam, high-sensitivity, sensor ideal for port crane anticollision and train detection. page 242	40 m	24° x 50°	DIP-switch-selectable NPN or PNP; N.O. or N.C.	159.5 x 90.8 x 62 mm	12 to 30 V dc
	<b>Q240RA</b> Radar-based dual-zone narrow-beam sensors for detection of moving and stationary targets page 243	100 m	11° x 13°	DIP-switchselectable NPN or PNP; N.O. or N.C.	186.9 x 159.9 x 55.5 mm	12 to 30 V dc
	<b>QT50R</b> FMCW Radar wide-beam easy-to-configure sensor ideal for traffic monitoring, ships, tollways, and car parking. page 244	24 m	90° x 76°	Bipolar NPN/PNP; DIP switch-selectable N.O. or N.C.	100.2 x 74.1 x 46.1 mm	12 to 30 V dc

# Q120R Series

## Radar-Based Adjustable-Field Sensor



- Radar-based narrow-beam sensors with high sensitivity for detection of moving and stationary targets
- Unaffected by wind, falling rain or snow, fog, humidity, air temperatures or light.
- FMCW (true-presence) radar detects moving and stationary objects
- 1 or 2 independent, adjustable sensing zones
- Easy setup and configuration of range, sensitivity and output with simple DIP switches
- Cordsets and brackets available see page 245

### Q120R Narrow Beam (24° x 50°)

Sensing Mode	Max Range <sup>†</sup>	Connection	Telecom Approval*	Output	Model
 ADJUSTABLE-FIELD	12 m	5-pin M12 QD	US, Canada and Brazil	Bipolar NPN/PNP	<b>Q120RA-US-AFQ</b>
			Europe, UK, Australia, New Zealand, Japan and China	Selectable NO or NC	<b>Q120RA-EU-AFQ</b>
			South Korea		<b>Q120RA-KR-AFQ</b>
 ADJUSTABLE-FIELD	40+ m	5-pin M12 QD	US, Canada and Brazil	(2) Selectable Dual NPN/PNP	<b>Q120RA-US-AF2Q</b>
			Europe, UK, Australia, New Zealand, Japan and China	Selectable NO or NC	<b>Q120RA-EU-AF2Q</b>
			South Korea		<b>Q120RA-KR-AF2Q</b>
 ADJUSTABLE-FIELD	26 m	5-pin M12 QD	US and Canada	(2) Selectable Dual NPN/PNP	<b>Q120RA-US-AF2WQ</b>
			Europe, UK, Australia, New Zealand, Japan and China	Selectable NO or NC	<b>Q120RA-EU-AF2WQ</b>
			South Korea		<b>Q120RA-KR-AF2WQ</b>

For more specifications see page 245.

QD models: A model with a QD requires a mating cordset (see page 245).

Cabled models: For cabled models, omit Q at the end of the QD model (example, Q120RA-US-AF2).

<sup>†</sup> Range is dependent on target object.

\* Contact factory at 1-888-373-6767 for additional information.

# Q240R Series

## Radar-Based Adjustable-Field Sensor



- Radar-based sensor has a very narrow beam pattern, making it an extremely robust solution for applications where users need to monitor a specific area without detecting adjacent objects
- FMCW (true-presence) radar detects moving and stationary objects
- Narrow beam pattern, high sensitivity, and long range
- Easy setup and configuration of range, sensitivity and output with simple DIP switches
- Two independent adjustable sensing zones (far and near proximity warning signal)
- Cordsets and brackets available see page 245

### Q240R Narrow Beam (11° x 13°)

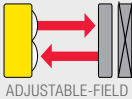
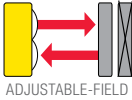
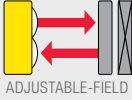
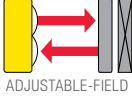
Sensing Mode	Max Range†	Connection	Telecom Approval*	Output	Model
 ADJUSTABLE-FIELD	40+ m	5-pin M12 QD	US, Canada and Brazil	(2) Selectable Dual NPN/PNP	Q240RA-US-AF2Q
			Europe, UK, Australia, New Zealand and Japan	Selectable NO or NC	Q240RA-EU-AF2Q
			China		Q240RA-CN-AF2Q
 ADJUSTABLE-FIELD	100 m	5-pin M12 QD	US and Canada	(2) Selectable Dual NPN/PNP	Q240RA-US-AF2LQ
			Europe, UK, Australia, New Zealand and Japan	Selectable NO or NC	Q240RA-EU-AF2LQ
			China		Q240RA-CN-AF2LQ
 ADJUSTABLE-FIELD	100 m	5-pin M12 QD	US and Canada	(1) 0-10 V Analog and (1) Selectable NPN/PNP	Q240RA-US-ULQ
			Europe, UK, Australia, New Zealand and Japan	Selectable NO or NC	Q240RA-EU-ULQ
			China		Q240RA-CN-ULQ
 ADJUSTABLE-FIELD	100 m	5-pin M12 QD	US and Canada	(1) 4-20 mA Analog and (1) Selectable NPN/PNP	Q240RA-US-ILQ
			Europe, UK, Australia, New Zealand and Japan	Selectable NO or NC	Q240RA-EU-ILQ
			China		Q240RA-CN-ILQ

For more specifications see page 245.

 QD models: A model with a QD requires a mating cordset (see page 245).

Cabled models: For cabled models, omit Q at the end of the QD model (example, Q240RA-US-AF2).

† Range is dependent on target object.

\* Contact factory at 1-888-373-6767 for additional information.

# QT50R Series

## Radar-Based Sensor



- Sensor's functions are unaffected by wind, rain, fog, light, humidity and temperature, making it ideal for outdoor environments
- Uses Frequency Modulated Continuous Wave (FMCW) to detect moving and stationary objects
- Easy setup and configuration of range, sensitivity and output with simple DIP switches
- Retroreflective models use a reference target, enabling reliable detection of weak targets in the foreground
- Adjustable-field models ignore objects beyond the set point

### QT50R Wide Beam (90° x 76°)

Sensing Mode	Max Range <sup>†</sup>	Connection	Telecom Approval*	Output	Model
ADJUSTABLE-FIELD	24 m	5-pin M12 QD	US, Canada and Brazil Europe, UK, Australia, New Zealand, Japan and China South Korea Taiwan	Bipolar NPN/PNP  Selectable NO or NC	QT50R-US-AFHQ QT50R-EU-AFHQ QT50R-KR-AFHQ QT50R-TW-AFHQ
ADJUSTABLE-FIELD	24 m	5-pin M12 QD	US, Canada and Brazil Europe, UK, Australia, New Zealand, Japan and China South Korea Taiwan	(2) Selectable NPN/PNP  Selectable NO or NC	QT50R-US-AF2Q QT50R-EU-AF2Q QT50R-KR-AF2Q QT50R-TW-AF2Q
ADJUSTABLE-FIELD	3.75 m	5-pin M12 QD	Europe, UK, Australia, New Zealand, Japan and China South Korea	Bipolar NPN/PNP  Selectable NO or NC	QT50R-EU-AFSQ QT50R-KR-AFSQ
RETRO	12 m	5-pin M12 QD	US, Canada and Brazil Europe, UK, Australia, New Zealand, Japan and China South Korea Taiwan	Bipolar NPN/PNP  Selectable NO or NC	QT50R-US-RHQ QT50R-EU-RHQ QT50R-KR-RHQ QT50R-TW-RHQ

QD models: A model with a QD requires a mating cordset.

Cabled models: For cabled models, omit Q at the end of the QD model (example, QT50R-US-AF2W).

<sup>†</sup> Range is dependent on target object.

\* Contact factory at 1-888-373-6767 for additional information.



5-Pin

**Euro-Style**

Straight connector models listed; for right-angle, add **RA** to the end of the model number (example, MQDEC2-506RA)

- MQDEC2-506  
2 m (6.5')
- MQDEC2-55  
5 m (15')
- MQDEC2-530  
9 m (30')



SMB30A



SMB30MM

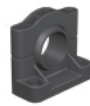

SMB30SC



SMBQ240SS1



SMBQ240SS2



SMBQ240SS3

Additional cordset information is available  
See page 758

Additional bracket information is available  
See page 725

**Weather Deflectors**



QT50RCK



SMBWSQ120



Q240WS

**Retro Wave Radar Target**



BRTR-CC20E



R-GAGE® QT50R

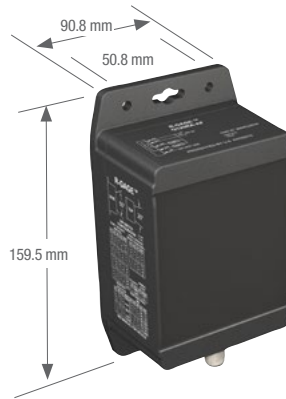

R-GAGE® Q120RA

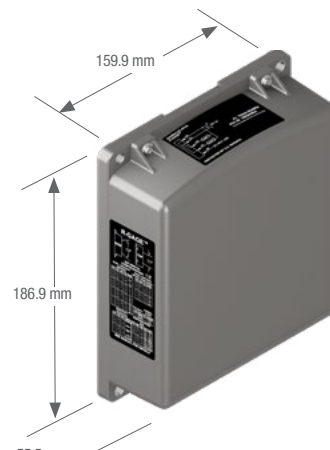

R-GAGE® Q240RA

**R-GAGE® Specifications**

Range	The sensor is able to detect a proper object (see Detectable Objects) from 0 to 100 m, depending on model
Detectable Objects	Objects containing metal, water or similar high-dielectric material
Operating Principle	Frequency Modulated Continuous Wave (FMCW) radar
Operating Frequency	24.00-24.25 GHz, ISM Band (varies slightly by model and national telecom regulations)
Supply Voltage	12 to 30 V dc, less than 100 mA (exclusive of load) <b>KR models:</b> 12 to 24 V dc
Supply Protection Circuitry	Protected against reverse polarity and transient overvoltages
Delay at Power-up	Less than 2 seconds
Output Configuration	NPN and PNP, N.O. and N.C., 150 mA each
Output Protection	Protected against short circuit conditions
Indicators	<b>Power LED:</b> Green (Power ON) <b>Signal Strength LED:</b> Red, flashes in proportion to signal strength <b>Output LEDs:</b> Yellow (output energized)/Red (configuration) See data sheets for more detailed information
Response Time	DIP-switch configurable ON/OFF response time
Adjustments	DIP-Switch configurable sensing distance, sensitivity, response time, and output configuration. Remote line TEACH for retroreflective models.
Construction	<b>Housing:</b> ABS/polycarbonate <b>Lightpipes:</b> Acrylic <b>Access Cap:</b> Polyester
Operating Temperature	-40 to +65 °C
Environmental Rating	IP67

**Certifications**





For more information regarding telecom approvals consult datasheet





## Arrays

Using an array of closely spaced light beams, measuring light screens are designed for profiling, inspections and process monitoring.

Series	Description	Minimum Object Detection Size	Dimensions H x W x D	Protection Rating	Housing Material	Power Supply
	<p><b>EZ-ARRAY™</b> Two piece measuring array page 248</p>	5 mm	H (varies by model) 36 x 45.2 mm	IP65	Aluminum with clear anodized finish	12 to 30 V dc
	<p><b>MINI ARRAY®</b> For inspections and profiling with a long range page 252</p>	19.1 mm	H (varies by model) 38.1 x 38.1 mm	IP65	Aluminum with black anodized finish	<b>Controller:</b> 16 to 30 V dc
	<p><b>High Res MINI ARRAY®</b> Excels at high-speed, precise monitoring and inspection applications page 256</p>	2.5 mm	H (varies by model) 38.1 x 38.1 mm	IP65	Aluminum with black anodized finish	<b>Controller:</b> 16 to 30 V dc

## EZ-ARRAY™

## Two-Piece Measuring Light Screens



- Two-piece light-screen design eliminates the need for a separate controller
- 5 mm beam spacing provides edge resolution of 2.5 mm
- High excess gain option for detecting opaque objects in single and double edge scan mode
- Seven zone LEDs provide instant alignment and beam blockage information
- Remote TEACH capable
- Rugged aluminum housing

## EZ-ARRAY™, 12-30 V DC, 5 mm Beam Spacing

Housing Length (L)	Array Length	Total Beams	Range*	Analog Output	Emitter Model	Receiver Model NPN Outputs	Receiver Model PNP Outputs
227 mm	150 mm	30	0.4 to 4 m	Current (4 to 20 mA) Voltage (0 to 10 V)	EA5E150Q	EA5R150NIXMODQ EA5R150NUXMODQ	EA5R150PIXMODQ EA5R150PUXMODQ
379 mm	300 mm	60		Current (4 to 20 mA) Voltage (0 to 10 V)	EA5E300Q	EA5R300NIXMODQ EA5R300NUXMODQ	EA5R300PIXMODQ EA5R300PUXMODQ
529 mm	450 mm	90		Current (4 to 20 mA) Voltage (0 to 10 V)	EA5E450Q	EA5R450NIXMODQ EA5R450NUXMODQ	EA5R450PIXMODQ EA5R450PUXMODQ
678 mm	600 mm	120		Current (4 to 20 mA) Voltage (0 to 10 V)	EA5E600Q	EA5R600NIXMODQ EA5R600NUXMODQ	EA5R600PIXMODQ EA5R600PUXMODQ
828 mm	750 mm	150		Current (4 to 20 mA) Voltage (0 to 10 V)	EA5E750Q	EA5R750NIXMODQ EA5R750NUXMODQ	EA5R750PIXMODQ EA5R750PUXMODQ
978 mm	900 mm	180		Current (4 to 20 mA) Voltage (0 to 10 V)	EA5E900Q	EA5R900NIXMODQ EA5R900NUXMODQ	EA5R900PIXMODQ EA5R900PUXMODQ
1128 mm	1050 mm**	210		Current (4 to 20 mA) Voltage (0 to 10 V)	EA5E1050Q	EA5R1050NIXMODQ EA5R1050NUXMODQ	EA5R1050PIXMODQ EA5R1050PUXMODQ
1278 mm	1200 mm**	240		Current (4 to 20 mA) Voltage (0 to 10 V)	EA5E1200Q	EA5R1200NIXMODQ EA5R1200NUXMODQ	EA5R1200PIXMODQ EA5R1200PUXMODQ
1578 mm	1500 mm**	300		Current (4 to 20 mA) Voltage (0 to 10 V)	EA5E1500Q	EA5R1500NIXMODQ EA5R1500NUXMODQ	EA5R1500PIXMODQ EA5R1500PUXMODQ
1878 mm	1800 mm**	360		Current (4 to 20 mA) Voltage (0 to 10 V)	EA5E1800Q	EA5R1800NIXMODQ EA5R1800NUXMODQ	EA5R1800PIXMODQ EA5R1800PUXMODQ
2178 mm	2100 mm**	420		Current (4 to 20 mA) Voltage (0 to 10 V)	EA5E2100Q	EA5R2100NIXMODQ EA5R2100NUXMODQ	EA5R2100PIXMODQ EA5R2100PUXMODQ
2478 mm	2400 mm**	480		Current (4 to 20 mA) Voltage (0 to 10 V)	EA5E2400Q	EA5R2400NIXMODQ EA5R2400NUXMODQ	EA5R2400PIXMODQ EA5R2400PUXMODQ

For more specifications see page 251.

 QD models: A model with a QD requires a mating cordset (see page 252).

\* Models with a range of 300 mm to 1500 mm models are available upon request. Contact factory at 1-888-373-6767 for more information.

\*\* Models with array lengths 1050 mm and longer ship with a center bracket and two end-cap brackets.

EZ-ARRAY™ IO-Link, 0-10 V DC–5 mm Beam Spacing

Housing Length (L)	Array Length	Total Beams	Range*	Emitter Model	Receiver Model PNP Outputs
227 mm	150 mm	30	0.4 to 4 m	EA5E150Q	EA5R150XKQ
379 mm	300 mm	60		EA5E300Q	EA5R300XKQ
529 mm	450 mm	90		EA5E450Q	EA5R450XKQ
678 mm	600 mm	120		EA5E600Q	EA5R600XKQ
828 mm	750 mm	150		EA5E750Q	EA5R750XKQ
978 mm	900 mm	180		EA5E900Q	EA5R900XKQ
1128 mm	1050 mm**	210		EA5E1050Q	EA5R1050XKQ
1278 mm	1200 mm**	240		EA5E1200Q	EA5R1200XKQ
1578 mm	1500 mm**	300		EA5E1500Q	EA5R1500XKQ
1878 mm	1800 mm**	360		EA5E1800Q	EA5R1800XKQ
2178 mm	2100 mm**	420		EA5E2100Q	EA5R2100XKQ
2478 mm	2400 mm**	480		EA5E2400Q	EA5R2400XKQ

For more specifications see page 251.

 QD models: A model with a QD requires a mating cordset (see page 252).

\* Models with a range of 300 mm to 1500 mm models are available upon request. Contact factory at 1-888-373-6767 for more information.

\*\* Models with array lengths 1050 mm and longer ship with a center bracket and two end-cap brackets.

# MEASUREMENT

# LASER

# ULTRASONIC

# RADAR



**M12/Euro-Style**  
Straight connector models listed; for right-angle, add **RA** to the end of the model number (example, **MAQDC-815RA**)

**8-Pin**  
**MAQDC-815** 4 m (13')  
**MAQDC-830** 9 m (30')  
**MAQDC-850** 15 m (49')

Additional cordset information is available  
See page 758



**Communication Cordsets**  
Straight connector models listed; for right-angle, add **RA** to the end of the model number (example, **MQDMC-506RA**)

**5-Pin**  
**MQDMC-506** 2 m (13')  
**MQDMC-515** 4 m (13')  
**MQDMC-530** 9 m (30')



**Double-Ended Euro-Style**  
Male/female straight Euro QD connectors

8-Pin	
<b>DEE2R-81D</b>	<b>DEE2R-825D</b>
0.31 m (1.0')	7.62 m (25.0')
<b>DEE2R-83D</b>	<b>DEE2R-850D</b>
0.91 m (3.0')	15.3 m (50.0')
<b>DEE2R-88D</b>	<b>DEE2R-875D</b>
2.44 m (8.0')	22.9 m (75.0')
<b>DEE2R-815D</b>	<b>DEE2R-8100D</b>
4.57 m (15.0')	30.5 m (100.0')

For IO-Link splitters see datasheet



**EZA-MBK-20**      **SMBLBCZB**

Additional bracket information is available  
See page 725

**Serial Adapters**



**EZA-USB485-01**      **INTUSB485-1**

Additional adapter information is available  
See page 819

**Stands**



Additional information is available  
See page 802

**Enclosures**



Additional information is available  
See page 808

**Lens Shields**





Additional information is available  
See page 812



**EZ-ARRAY Light Screen**  
W = 36.0 mm      D = 45.2 mm  
L = Length (see model chart page 255)

EZ-ARRAY™ Specification

Supply Voltage (Limit Values)	<p><b>Emitter:</b> 12 to 30 V dc  <b>Receiver Analog Current Models:</b> 12 to 30 V dc    <b>Receiver Analog Voltage Models:</b> 15 to 30 V dc  <b>IO-Link receiver:</b> 18 to 30 V dc</p>
Supply Power Requirements	<p><b>Emitter/Receiver Pair (Exclusive of discrete load):</b> Less than 9 watts    <b>Power-up delay:</b> 2 seconds</p>
Emitter/Receiver Range	400 mm to 4 m
Field of View	Nominally ± 3°
Beam Spacing	5 mm
Light Source	Infrared LED
Minimum Object Detection Size	<p><b>Straight Scan, Low-Contrast:</b> 5 mm  <b>Straight Scan, High-Excess-Gain:</b> 10 mm</p>
Sensor Positional Resolution	<p><b>Straight Scan:</b> 5 mm    <b>Double-Edge Scan:</b> 2.5 mm    <b>Single-Edge Scan:</b> 2.5 mm</p>
Teach Input (Receiver Gray Wire)	<p><b>Low:</b> 0 to 2 volts    <b>High:</b> 6 to 30 volts or open (input impedance 22 kΩ)</p>
Two Discrete Outputs	<p>Solid-State NPN or PNP (current sinking or sourcing)  <b>Rating:</b> 100 mA max. each output  <b>OFF-State Leakage Current:</b> <b>NPN:</b> less than 200 uA @ 30 V dc    <b>PNP:</b> less than 10 uA @ 30 V dc  <b>ON-State Saturation Voltage:</b> <b>NPN:</b> less than 1.6 V @ 100 mA    <b>PNP:</b> less than 2.0 V @ 100 mA                      Protected against false pulse on power-up and continuous overload or short circuit.</p> <p><b>IO-Link Model:</b>                      Discrete Output 1 (SIO Mode)  <b>Type:</b> Solid-State Push-Pull  <b>Rating:</b> 100 mA maximum (sourcing or sinking)  <b>ON-State Saturation Voltage:</b> less than 3V @100mA (sourcing or sinking)</p>
Two Analog Outputs	<p><b>Voltage Sourcing:</b> 0 to 10 V (maximum current load of 5 mA)  <b>Current Sourcing:</b> 4 to 20 mA (maximum resistance load = (Vsupply-3)/0.020)</p>
Serial Communication Interface	<p>EIA-485 Modbus RTU (up to 15 nodes per communication ring)                      RTU binary format  <b>Baud Rate:</b> 9600, 19.2K or 38.4K    IO-Link Baud Rate: 38,400 bps (COM2) 8 Data Bits, 1 Stop Bit, and Even, Odd, or 2 Stop Bits and No Parity  <b>Process data width:</b> 16 bits</p>
Scan Time	Scan times depend on scan mode and sensor length. Straight scan times range from 2.8 to 26.5 milliseconds.
Status Indicators	<p><b>Emitter:</b> Red Status LED                      ON Steady—Status                      Flashing at 1 hz—Error</p> <p><b>IO-Link:</b> <b>Green:</b> IO-Link OK  <b>Yellow flashing:</b> IO-Link Comm  <b>Solid Red:</b> IO-Link error</p> <p><b>Receiver:</b>                      7 Zone Indicators                      Red—Blocked channels within zone    Green—All channels clear within zone                      3-digit 7-segment indicators for measurement mode/diagnostic information                      Sensor Status Bicolor Indicator LED                      Red—Hardware Error or Marginal Alignment    Green—OK</p> <p><b>Modbus Activity Indicator LED:</b> Yellow  <b>Modbus Error Indicator LED:</b> Red</p>
System Configuration (Receiver Interface)	<p><b>6-position DIP switch:</b> Used to set scanning type, measurement modes, analog slope and discrete output 2 function. Alternate software GUI interface provides additional options; see full manual.  <b>Push Buttons:</b> Two momentary push buttons for alignment and gain level selection  <b>IO-Link models:</b> Supplied IODD files provide all configuration options (see manual)</p>
Connections	<p><b>Serial communication:</b> The receiver uses a PVC-jacketed, 5-conductor 22-gauge quick-disconnect cable, 5.4 mm diameter. QD cordsets are ordered separately.  <b>Other Sensor connections:</b> 8-conductor quick-disconnect cordsets (one each for emitter and receiver), ordered separately (may not exceed 75 m long), PVC-jacketed cordsets measure 5.8 mm diameter, have shield wire; 22-gauge conductors.</p>
Construction	Aluminum housing with clear-anodized finish; acrylic lens cover
Environmental Rating	IEC IP65
Operating Conditions	<p><b>Temperature:</b> -40 to +70 °C    <b>Relative humidity:</b> 95% at 50 °C (non-condensing)</p>
Certification	 

# MINI-ARRAY® Series

## Measuring Light Screens

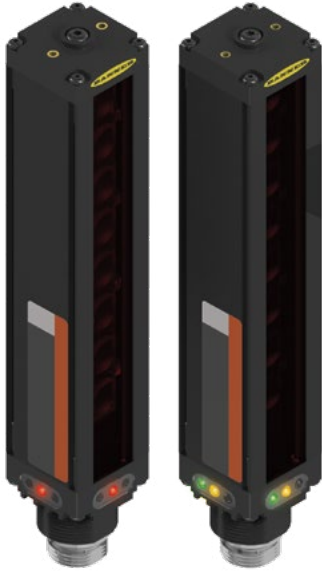

The MINI-ARRAY® is a programmable measuring light screen for inspections and profiling with a long range up to 16.5 m.

- Offers programmable controller with a selection of measurement modes, scan modes and output configurations
- Available with 9.5 or 19 mm beam spacing for detecting objects as small as 12.7 mm
- Advanced software GUI
- Highly visible indicators for status monitoring

### MINI-ARRAY® 19.1 mm Beam Spacing

Max Range	Minimum Object Size	Total Beams	3-Piece Models*			2-Piece Models		
			Length (L)	Emitter	Receiver	Length (L)	Emitter	Receiver
16.5 m	Interlaced Mode: 25.4 mm  Other scan modes: 38.1 mm	8	201 mm	BMEL616A	BMRL616A	231 mm	MAE616Q	MAR616NX485Q
		16	356 mm	BMEL1216A	BMRL1216A	384 mm	MAE1216Q	MAR1216NX485Q
		24	505 mm	BMEL1816A	BMRL1816A	536 mm	MAE1816Q	MAR1816NX485Q
		32	659 mm	BMEL2416A	BMRL2416A	689 mm	MAE2416Q	MAR2416NX485Q
		40	810 mm	BMEL3016A	BMRL3016A	841 mm	MAE3016Q	MAR3016NX485Q
		48	963 mm	BMEL3616A	BMRL3616A	993 mm	MAE3616Q	MAR3616NX485Q
		56	1115 mm	BMEL4216A	BMRL4216A	1146 mm	MAE4216Q	MAR4216NX485Q
13.5 m	Interlaced Mode: 25.4 mm  Other scan modes: 38.1 mm	64	1267 mm	BMEL4816A	BMRL4816A	1298 mm	MAE4816Q	MAR4816NX485Q
		72	–	–	–	1451 mm	MAE5416Q	MAR5416NX485Q
		80	1572 mm	BMEL6016A	BMRL6016A	1514 mm	MAE6016Q	MAR6016NX485Q
		88	–	–	–	1667 mm	MAE6616Q	MAR6616NX485Q
		96	1877 mm	BMEL7216A	BMRL7216A	1819 mm	MAE7216Q	MAR7216NX485Q

For more specifications see page 255.

 QD models: A model with a QD requires a mating cordset (see page 254).

\* One controller and an emitter/receiver pair (of matching length and resolution) required per system.



MINI-ARRAY® 9.5 mm Beam Spacing

Max Range	Minimum Object Size	Total Beams	Length (L)	3-Piece Models*		2-Piece Models		
				Emitter	Receiver	Length (L)	Emitter	Receiver
6.1 m	Interlaced Mode: 12.7 mm  Other scan modes: 19.1 mm	16	201 mm	BMEL632A	BMRL632A	231 mm	MAE632Q	MAR632NX485Q
		32	356 mm	BMEL1232A	BMRL1232A	384 mm	MAE1232Q	MAR1232NX485Q
		48	505 mm	BMEL1832A	BMRL1832A	536 mm	MAE1832Q	MAR1832NX485Q
		64	659 mm	BMEL2432A	BMRL2432A	689 mm	MAE2432Q	MAR2432NX485Q
		80	810 mm	BMEL3032A	BMRL3032A	841 mm	MAE3032Q	MAR3032NX485Q
		96	963 mm	BMEL3632A	BMRL3632A	993 mm	MAE3632Q	MAR3632NX485Q
		112	1115 mm	BMEL4232A	BMRL4232A	1146 mm	MAE4232Q	MAR4232NX485Q
		128	1267 mm	BMEL4832A	BMRL4832A	1298 mm	MAE4832Q	MAR4832NX485Q
4.6 m	Interlaced Mode: 12.7 mm  Other scan modes: 19.1 mm	144	-	-	-	1451 mm	MAE5432Q	MAR5432NX485Q
		160	1572 mm	BMEL6032A	BMRL6032A	1603 mm	MAE6032Q	MAR6032NX485Q
		176	-	-	-	1755 mm	MAE6632Q	MAR6632NX485Q
		192	1877 mm	BMEL7232A	BMRL7232A	1908 mm	MAE7232Q	MAR7232NX485Q

MINI-ARRAY® Controllers\*, 16-30 V DC

Inputs	Solid-State Discrete Outputs	Analog Outputs	Serial Output	Controller Models
1 Sensor pair & Trigger (Gate)	1 Reed & 1 NPN	-	RS-232 & RS-485	MAC-1
	2 NPN	-		MACN-1
	2 PNP	-		MACP-1
	1 NPN	(2) 0-10 V Sourcing	RS-232	MACV-1
	1 NPN	(2) 4-20 mA Sinking		MACI-1
1 Sensor pair & Trigger (Gate)	16 NPN	-	RS-232	MAC16N-1
	16 PNP	-		MAC16P-1

For more specifications see page 255.

 QD models: A model with a QD requires a mating cordset (see page 254).  
\* One controller and an emitter/receiver pair (of matching length and resolution) required per 3-piece system.

Used with 2-Piece Arrays

Used with 3-Piece Arrays

**Euro-Style with Shield**  
Straight connector models only



**8-Pin**  
**MAQDC-806**  
2 m (6')  
**MAQDC-8015**  
4.5 m (15')  
**MAQDC-830**  
9 m (30')  
**MAQDC-850**  
15 m (50')

**Communication Cordsets**

Straight connector models listed; for right-angle, add **RA** to the end of the model number (example, **MQDMC-506RA**)



**5-Pin**  
**MQDMC-506**  
2 m (13')  
**MQDMC-515**  
4 m (13')  
**MQDMC-530**  
9 m (30')



DIN-35-..



MSMB-3

Additional bracket information is available  
See page 725

Additional cordset information is available  
See page 758

Stands



Additional information is available  
See page 802

Enclosures



Additional information is available  
See page 808

Lens Shields



Additional information is available  
See page 812

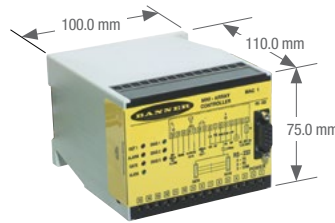

MINI-ARRAY Controller

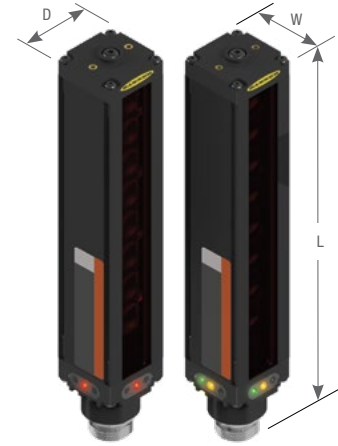

MINI-ARRAY Sensors

W = 38.1 mm      D = 38.1 mm  
L = Length (see model chart)

MINI-ARRAY® 3-Piece Set, Emitter/Receiver Specifications

<b>Max Emitter/Receiver Range</b>	<b>9.5 mm beam spacing:</b> Length 201 to 1115 mm: 6.1 m Length 1267 to 1877 mm: 4.6 m	<b>19.1 mm beam spacing:</b> Length 201 to 1115 mm: 16.5 m Length 1267 to 1877 mm: 13.5 m
<b>Minimum Object Sensitivity</b>	<b>9.5 mm Beam Spacing:</b> Straight, Edge Modes: 19.1 mm Interlaced Mode: 12.7 mm* Skip Mode: Multiply the above by the number of skipped beams, plus 1 Interlaced Mode: 12.7 mm*	<b>19.1 mm Beam Spacing:</b> Straight, Edge Modes: 38.1 mm Interlaced Mode: 25.4 mm* Skip Mode: Multiply the above by the number of skipped beams, plus 1 Interlaced Mode: 25.4 mm*
*Assumes sensing is in the middle 1/3 of sensing range		
<b>Sensor Scan Time</b>	55 microseconds per beam, plus 1 millisecond post process time per scan	
<b>Power Requirements</b> †Maximum current is for a 6' sensor	<b>9.5 mm beam spacing:</b> 12 V dc ±2%, supplied by controller Emitter: 0.10 A @ 12 V dc Receiver: 0.75 A @ 12 V dc†	<b>19.1 mm beam spacing:</b> 12 V dc ±2%, supplied by controller Emitter: 0.10 A @ 12 V dc Receiver: 0.50 A @ 12 V dc†
<b>Status Indicators</b>	<b>Emitter:</b> Red LED lights to indicate proper emitter operation <b>Receiver:</b> Green indicates sensors aligned (> 3x excess gain) Amber indicates marginal alignment of one or more beams (1x -3x excess gain) Red indicates sensors misaligned or one or more beam(s) blocked	
<b>Construction</b>	Aluminum, with black anodized finish; acrylic lens cover	
<b>Environmental Rating</b>	NEMA 4, 13; IP65	
<b>Certification</b>		



# High Resolution MINI-ARRAY®

## High-Resolution Measuring Light Screens

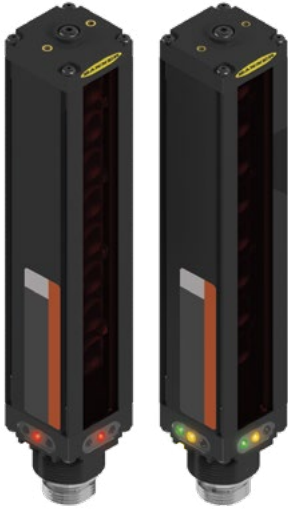

- Offers programmable controller with a selection of measurement modes scan modes and output configurations
- 120 sensing beams per foot provides reliable detection of objects as small as 2.5 mm
- Features a 1.8 m range and easy alignment
- Advanced software GUI
- Highly visible indicators for status monitoring

### High-Resolution MINI-ARRAY®, 2.5 mm Beam Spacing

Housing Length (L)	Array Length	Total Beams	Connection	Range	Minimum Object Size	Models*	
						Emitters	Receivers
236 mm	163 mm	64	5-pin Mini QD	0.4 to 1.8 m	2.5 mm	MAHE6A	MAHR6A
399 mm	325 mm	128				MAHE13A	MAHR13A
561 mm	488 mm	192				MAHE19A	MAHR19A
724 mm	650 mm	256				MAHE26A	MAHR26A
887 mm	813 mm	320				MAHE32A	MAHR32A
1049 mm	975 mm	384				MAHE38A	MAHR38A
1215 mm	1138 mm	448				MAHE45A	MAHR45A
1377 mm	1300 mm	512				MAHE51A	MAHR51A
1540 mm	1463 mm	576				MAHE58A	MAHR58A
1703 mm	1626 mm	640				MAHE64A	MAHR64A
1865 mm	1788 mm	704				MAHE70A	MAHR70A
2028 mm	1951 mm	768	MAHE77A	MAHR77A			

For more specifications see page 258.

 QD models: A model with a QD requires a mating cordset.

\* "E" and "R" in model numbers denotes "Emitter" and "Receiver" respectively. Sold separately.

High-Resolution MINI-ARRAY® Controllers†, 16-30 V DC

Inputs	Solid-State Discrete Outputs	Analog Outputs	Serial Output	Controller Models
1 Sensor pair & Trigger (Gate)	2 PNP	(2) 0 to 10 V Sourcing	RS-232 & RS-485	MAHCVP-1
	2 NPN	(2) 0 to 10 V Sourcing		MAHCVN-1
	2 PNP	(2) 4 to 20 mA Sinking		MAHCIP-1
	2 NPN	(2) 4 to 20 mA Sinking		MAHCIN-1



† One controller and an emitter/receiver pair (of matching length) required per system.

**Mini-Style Cordsets**  
Straight connector models only



- 5-Pin**  
**QDC-515C** 5 m (15')  
**QDC-525C** 8 m (25')  
**QDC-550C** 15 m (50')  
**MAQDC-575C** 23 m (75')  
**MAQDC-5100C** 30.5 m (100')  
**MAQDC-5150C** 45.5 m (150')

**DB9 Communication Cordset** | **9-Pin MASC** 2 m (13')



DIN-35-..

MSMB-3

Additional bracket information is available  
See page 725

Additional cordset information is available  
See page 758

Stands



Additional information is available  
See page 802

Enclosures



Additional information is available  
See page 808

Lens Shields



Additional information is available  
See page 812

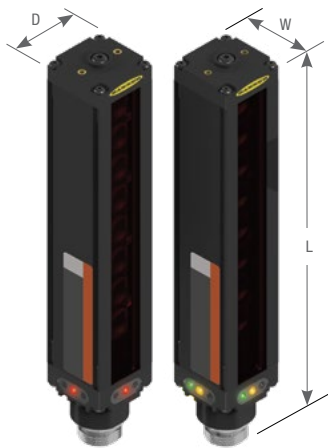

MINI-ARRAY Sensors

W = 38.1 mm      D = 38.1 mm  
L = Length (see model chart page 256)

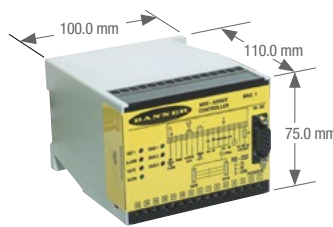

MINI-ARRAY Controller

## High-Resolution MINI-ARRAY® Emitter/Receiver Specifications

Emitter/Receiver Range	380 mm to 1.8 m
Minimum Object Sensitivity	2.5 mm
Sensor Scan Time	1.8 to 58.4 milliseconds, depending on scanning method and sensor length plus 1 millisecond post processing time for controller
Power Requirements	12 V dc $\pm$ 2%, supplied by controller
Connections	Sensors connect to controller using two 5-conductor quick-disconnect cordset (one each for emitter and receiver), ordered separately. Use only Banner cordset, which incorporate a "twisted pair" for noise immunity. Cordsets measure 8.1 mm in diameter and are shielded and PVC-jacketed. Conductors are 20 gauge (0.9 mm). Emitter and receiver cordset may not exceed 75 m long, each. See page 257.
Status Indicators	<b>Emitter:</b> Red LED lights to indicate proper emitter operation <b>Receiver:</b> Green indicates sensors aligned Yellow indicates marginal alignment of one or more beams Red indicates sensors misaligned or one or more beam(s) blocked
Construction	Aluminum, with black anodized finish; acrylic lens cover
Environmental Rating	NEMA 4, 13; IP65
Operating Conditions	<b>Temperature:</b> 0 to +50 °C <b>Relative humidity:</b> 95% at 50 °C (non-condensing)
Certifications	

## High-Resolution MINI-ARRAY® Controller Specifications

Power Requirements	16 to 30 V dc @ 1.0 A (typical: 0.5 A @ 16 V dc)
Inputs	<p><b>Sensor input:</b> Emitter and receiver wire in parallel to five terminals</p> <p><b>Trigger (Gate) input:</b> Optically isolated, requires 10 to 30 V dc (7.5 kΩ impedance) for gate signal</p> <p><b>Remote alignment input:</b> Optically isolated, requires 10 to 30 V dc (7.5 kΩ impedance) for alignment sequence signal</p>
Discrete (Switched) Outputs	<p><b>NPN outputs:</b> Open collector NPN transistor rated at 30 V dc max., 150 mA max.</p> <p><b>PNP outputs:</b> Open collector PNP transistor rated at 30 V dc max., 150 mA max.</p> <p><b>All discrete outputs:</b> <b>OFF-state leakage current:</b> less than 10 μA @ 30 V dc</p> <p><b>ON-state saturation voltage:</b> less than 1 V @ 10 mA; less than 1.5 V @ 150 mA</p>
Serial Data Outputs	<p>RS-232 or RS-485 interface. (Up to 15 control modules may be given unique addresses on one RS-485 party line.)</p> <p>ASCII or binary data format</p> <p>9600, 19.2K or 38.4K baud rate</p> <p>8 data bits 1 stop bit, and even, odd or no parity</p>
Analog Outputs	<p><b>Voltage-sourcing outputs:</b> 0 to 10 V dc (25 mA current limit)</p> <p><b>Current-sinking outputs:</b> 4 to 20 mA (16 to 30 V dc input)</p> <p><b>Resolution:</b> Span / Number of sensing channels</p> <p><b>Linearity:</b> 0.1% of full scale</p> <p><b>Temperature variation:</b> 0.01% of full scale per °C</p>
Output Configuration	<p><b>MAHCVP-1:</b> Two PNP discrete (switched), two 0-10 V voltage sourcing</p> <p><b>MAHCVN-1:</b> Two NPN discrete (switched), two 0-10 V voltage sourcing</p> <p><b>MAHCIP-1:</b> Two PNP discrete (switched), two 4-20 mA current sinking</p> <p><b>MAHCIN-1:</b> Two NPN discrete (switched), two 4-20 mA current sinking</p>
System Programming	Via RS-232 interface to PC-compatible computer running Windows® XP, Vista, Windows 7, Windows 8 and using software supplied with each control module
Status Indicators	<p><b>Output 1 (Red):</b> Lights to indicate Discrete Output #1 is active</p> <p><b>Alarm (Red):</b> Lights to indicate Discrete Output #2 is active</p> <p><b>Gate (Red):</b> Lights to indicate Trigger (Gate) is active</p> <p><b>Align (Green):</b> Lights to indicate emitter and receiver are aligned</p> <p><b>Diagnostics indicator:</b> (Key on controller side label) Identifies System errors and status</p>
Construction	Polycarbonate housing; mounts to flat surface or directly onto 35 mm DIN rail
Environmental Rating	NEMA 1; IP20
Operating Conditions	<b>Temperature:</b> 0 to +50 °C <b>Relative humidity:</b> 95% @ 50 °C (non-condensing)
Certifications	







---

## Temperature & Vibration

Temperature sensors detect small differences between the temperature of an object and the surrounding ambient temperature. Vibration and temperature sensor measures RMS velocity, in inches per second or millimeters per second, and temperature.

Series	Description	Minimum Object Detection Range	Dimensions H x W x D	Protection Rating	Housing Material	Power Supply
	<p><b>M18T</b> Works on moving or still products by detecting infrared energy that objects emit. page 262</p>	1 m	18 mm ø x (varies by model)	IP67 NEMA 6	Stainless Steel	12 to 30 V dc
	<p><b>M12F</b> Designed to work as a Modbus slave device via RS-485 or with Sure Cross® Wireless products page 264</p>	264	12 mm ø x (varies by model)	IP67 NEMA 6	Metal	12 to 24 V dc 3.6 to 5.5 V dc
	<p><b>QM42VT</b> Provides high accuracy vibration (velocity RMS) and temperature measurements page 266</p>		42 x 13 x 42 mm	IP67 NEMA 6	Zinc alloy	3.6 to 5.5 V dc

# M18T Series

## Non-Contact Temperature Sensors



- Senses temperature differences as small as 3 °C, on moving or still products
- Senses from 0 to 300 °C
- Allows threshold adjustment and real-time information display through a PC
- Requires no emitter or controller
- Uses remote or push-button programming

### M18T

Sensing Face	D:S Ratio*	Output	Connection	Models
Integrated lens	8:1	0 to 10 V dc analog, plus PNP Alarm	2 m	M18TUP8
			5-pin Euro QD	M18TUP8Q
Enclosed Plastic face (for food industry use)	6:1	0 to 10 V dc analog, plus PNP Alarm	2 m	M18TUP6E
			5-pin Euro QD	M18TUP6EQ
Germanium lens	14:1	0 to 10 V dc analog, plus PNP Alarm	2 m	M18TUP14
			5-pin Euro QD	M18TUP14Q
Integrated lens	8:1	4 to 20 mA analog, plus PNP Alarm	2 m	M18TIP8
			5-pin Euro QD	M18TIP8Q
Enclosed Plastic face (for food industry use)	6:1	4 to 20 mA analog, plus PNP Alarm	2 m	M18TIP6E
			5-pin Euro QD	M18TIP6EQ
Germanium lens	14:1	4 to 20 mA analog, plus PNP Alarm	2 m	M18TIP14
			5-pin Euro QD	M18TIP14Q

 Connection options: A model with a QD requires a mating cordset.

For 9 m cable, add suffix W/30 to the 2 m model number (example, M18TUP8 W/30).

\* For a sensor with an 8:1 D:S ratio, the sensor's spot size is a 1" diameter circle at a distance of 8"

**M12/Euro-Style with Shield**

Straight connector models listed; for right-angle, add **RA** to the end of the model number (example, **MQDEC2-506RA**)



**5-Pin**  
**MQDEC2-506**  
 2 m (6.5')  
**MQDEC2-515**  
 5 m (15')  
**MQDEC2-530**  
 9 m (30')

Additional cordset information is available  
 See page 758



SMB18A



SMB18SF



SMB18UR

Additional bracket information is available  
 See page 723



**APC-18**  
 Air Purge Collar  
 (sensor not included)



**LAT1812**  
 Laser Alignment Tool



**Cabled Models (L)**

M18T..Q8	81.3 mm
M18T..6EQ	81.7 mm
M18T..14Q	86.5 mm



**QD Models (L)**

M18T..Q8	91.3 mm
M18T..6EQ	91.8 mm
M18T..14Q	96.6 mm

**M18T Specifications**

Supply Voltage and Current	12 to 30 V dc
Wavelength	8 to 14 μm
Supply Protection Circuitry	Protected against reverse polarity and transient voltages
Output Response Time	75 ms (for a 95% step change)
Delay at Power-up	1.5 second
Repeatability	± 1% of measurement, or ± 1 °C, whichever is greater
Construction	<b>Threaded Barrel:</b> Stainless steel <b>Housing:</b> ABS/PC
Environmental Rating	IEC IP67; NEMA 6
Sensing Field of View	See datasheet
Performance Curves	See datasheet
Operating Conditions	<b>Temperature:</b> -20 to +70 °C
Certifications	<b>CE</b>

# M12F Series

## Temperature and Humidity Sensors



- Manufactured with a robust metal housing
- Designed to work as a Modbus slave device via RS-485 or with Sure Cross® 1-wire serial interface -P6 nodes, -H6 MultiHop Radios, or Q45 Sensor Node DX80N2Q45TH
- Ships with aluminum grill filter cap; optional stainless steel 10 micrometer sintered filter available separately

### M12FTH Temperature and Humidity

I/O	Power	Connection	Models
RS-485 Modbus	3.6 to 5.5 V dc low power option or 12 to 24 V dc	5-pin Euro QD	M12FTH3Q
1-wire serial interface	3.6 to 5.5 V dc		M12FTH4Q

### M12FT Temperature

I/O	Power	Connection	Models
RS-485 Modbus	3.6 to 5.5 V dc low power option or 12 to 24 V dc	5-pin Euro QD	M12FT3Q
1-wire serial interface	3.6 to 5.5 V dc		M12FT4Q



**Double Ended M12/Euro-Style with Shield**  
 Straight connector models only straight male to straight female

**5-Pin**  
**DEE2R-51D** 0.3 m (1')  
**DEE2R-53D** 1 m (3')  
**DEE2R-58D** 2.5 m (8')

*Additional cordset information is available See page 758*

**Filter Caps**



**FTH-FIL-001**  
 Aluminum Grill Filter Cap



**FTH-FIL-002**  
 Stainless Steel Filter Cap

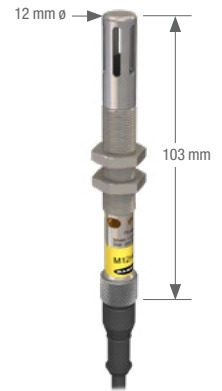

**M12F Specifications**

<b>Supply Voltage and Current</b>	3.6 to 5.5 V dc low power option or 12 to 24 V dc
<b>Resolution</b>	<b>Humidity:</b> 0.1% relative humidity <b>Temperature:</b> 0.1 °C
<b>Construction</b>	<b>Housing:</b> metal
<b>Environmental Rating</b>	IEC IP67; NEMA 6
<b>Operating Conditions</b>	<b>Temperature:</b> -40 °C to +85 °C
<b>Certifications</b>	 c Us CSA: Class I, Division 2, Groups A, B, C, D — Certificate 1921239

# QM42VT Series

## Vibration and Humidity Sensors



- Provides high accuracy vibration (velocity RMS) and temperature measurements
- Manufactured with a robust zinc alloy housing
- Connects via a 1-wire serial interface
- Reduces labor costs by obviating manual checks and eliminating error

### QM42VT

I/O	Power	Connection	Models
1-Wire Serial	3.6 to 5.5 V dc	3 m	QM42VT1
RS-485 Modbus	3.6 to 5.5 V dc low power option or 10 to 24 V dc	3 m	QM42VT2



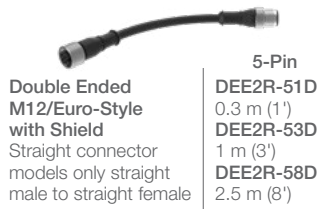

Double Ended M12/Euro-Style with Shield  
Straight connector models only straight male to straight female

5-Pin  
DEE2R-51D 0.3 m (1')  
DEE2R-53D 1 m (3')  
DEE2R-58D 2.5 m (8')

Additional cordset information is available  
See page 758



RS-485 to USB Adaptor

BWA-HW-006



RS-485 to USB Adaptor

BWA-USB1WIRE-001



BWA-BK-002



BWA-BK-001



QM42VT Specifications

Supply Voltage and Current	3.6 to 5.5 V dc or 10 to 24 V dc
Vibration	<p><b>Mounted base resonance:</b> 5.5 kHz nominal</p> <p><b>Measuring range:</b> 0-46 mm/sec or 0-1.8 in/sec RMS</p> <p><b>Frequency Range:</b> 10 – 1000 Hz</p> <p><b>Accuracy:</b> ± 10% @25 °C</p>
Temperature	<p><b>Measuring range:</b> -40 to +105 °C (-40 to +221 °F)</p> <p><b>Resolution:</b> 0.1 °C Accuracy: ±3 °C</p>
Construction	<b>Housing:</b> Zinc alloy
Shock	400G
Environmental Rating	IEC IP67; NEMA 6
Operating Conditions	<b>Temperature:</b> -40 to +105 °C

Certifications





## Special Purpose

Special purpose sensors provide a variety of choices for challenging environments and applications where standard sensors don't make the cut. From hazardous areas and heavy duty washdown environments to sensing specific colors and temperatures for maximum accuracy, special purpose sensors meet specific application needs.

# SPECIAL PURPOSE

---

BARCODE READERS **page 270**

REGISTRATION, COLOR &  
LUMINESCENCE **page 282**

STAINLESS STEEL **page 296**

CLEAR OBJECT **page 312**

TEMPERATURE **page 324**

HAZARDOUS AREA **page 328**



## Barcode Readers

Able to decode over a dozen commonly used 1D and 2D barcode symbols, provides fast read rates, wide depth of field, and high resolution.

Series	Description	Max Sensing Range	Dimensions (H x W x D)	Housing Material	Power Supply
	<p><b>iVu BCR</b> Easy to set up, powerful, affordable inspection solution solves a wide variety of simple and complex applications. page 272</p>	Varies by selected lens	95.3 x 81.2 x 53.2 mm	Black PBT	10-30 V dc
	<p><b>P4 BCR</b> Find and decode 2D and 1D linear bar codes. page 278</p>	Varies by selected lens	124.5 x 66.8 x 34.3 mm	Black anodized aluminum	10-30 V dc
	<p><b>Laser Barcode Scanner</b> Can detect over a dozen of the most commonly used linear barcode symbols with a fast reading rate. page 280</p>	600 mm	68 x 83.4 x 32.8 mm	Black anodized aluminum	10-30 V dc



# iVu BCR and iVu Plus BCR

## Bar Code Reader (BCR)



- Powerful, affordable inspection solution solves a wide variety of simple and complex applications
- Solve a variety of linear and 2D bar code applications
- First-time users can have it up and running in minutes
- Optional remote touch screen for programming
- Ability to change parameters on the fly
- iVu BCR Plus models have Ethernet communication available and is capable of storing and controlling up to 30 inspections for fast product change over

### iVu BCR Applications

#### Bar Code Type



Reading a 1D barcode

#### Screen Interface Pass

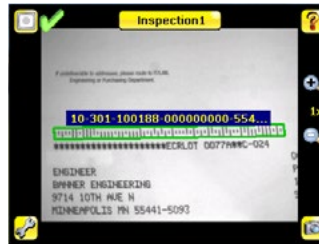

#### Screen Interface Fail



Reading a 2D barcode

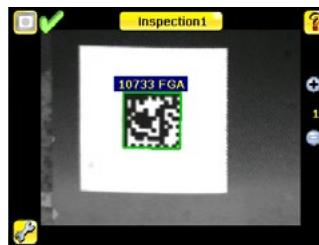

- No PC required to configure, change or monitor
- Built-in or remote touch screen
- Self-contained sensor with easy configuration and convenient monitoring right on the sensor



Installation and configuration in four easy steps

1. Install and connect the sensor
2. Select the sensor or bar code type, depending on model
3. Acquire a good image
4. Set inspection parameters



Intuitive operation with menu driven tools to guide you through setup

- Define region of interest
- Adjust intensity/contrast
- Define the pass criteria



Conducts high-performance reading of industry standard barcodes.

Reads up to ten 1D and 2D bar codes at one time.

**2D Bar Codes**  
Data Matrix (ECC200)  
QR & Micro QR

**1D Bar Codes**  
Code 128                      EAN-13 (UPC-A)                      Postnet  
Code 39                        EAN-8                                      Pharmcode  
Codabar                        UPC-E  
Interleaved 2 of 5            IMB

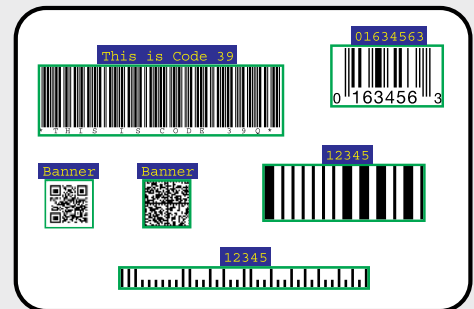



iVu BCR (Barcode Reader)

Example Model Number: IVU2PRBR04

Family	Touch Screen	Ring Light Color	Lens (mm)
<b>IVU2P</b>	<b>RB</b>	<b>R</b>	<b>04</b>
<b>IVU2</b> = Reads 1D and 2D <b>IVU2P</b> = Reads 1D and 2D with Ethernet and storage for 30 inspections	<b>TB</b> = Integrated <b>RB</b> = Remote	<b>R</b> = Red <b>B</b> = Blue <b>G</b> = Green <b>W</b> = White <b>I</b> = Infrared <b>6</b> = UV365 <b>9</b> = UV395 <b>XC</b> = C-mount* <b>X</b> = No Ring Light	<b>04</b> = 4.3 <b>06</b> = 6 <b>08</b> = 8 <b>12</b> = 12 <b>16</b> = 16 <b>25</b> = 25 <b>Blank</b> = No lens (only C-Mount)

\* Requires C-mount lens. For C-Mount lenses see page 362

<b>Power</b> <b>M12/Euro-Style with Shield</b> Straight connector models listed; for right-angle, add <b>RA</b> to the end of the model number (example, <b>MQDC2S-1206RA</b> )		<b>12-Pin</b> <b>MQDC2S-1206</b> 2 m (6.5') <b>MQDC2S-1215</b> 5 m (15') <b>MQDC2S-1230</b> 9 m (30') <b>MQDC2S-1250</b> 15 m (50')	<b>USB</b> Straight connector models listed		<b>8-Pin Euro**</b> <b>MQDEC-8005-USB</b> 0.15 m (0.5') <b>MQDEC-801-USB</b> 0.3 m (1') <b>MQDEC-803-USB</b> 0.9 m (3') <b>MQDEC-810-USB</b> 3 m (10')	<b>4-Pin Pico</b> <b>PSG-4M-4005-USB</b> 0.15 m (0.5') <b>PSG-4M-401-USB</b> 0.3 m (1') <b>PSG-4M-403-USB</b> 0.9 m (3') <b>PSG-4M-410-USB</b> 3 m (10')
<b>Ethernet</b> <b>RJ45 to 4-Pin Pico QD</b>		<b>4-Pin</b> <b>IVUC-E-406</b> 2 m (6.5') <b>IVUC-E-415</b> 5 m (15') <b>IVUC-E-430</b> 9 m (30')	<b>IVUC-E-450</b> 12 m (50') <b>IVUC-E-475</b> 23 m (75')	<b>Used with:</b> BCR with Integrated Touch Screen	<b>Used with:</b> BCR with Remote Touch Screen and BCR Plus with Remote or Integrated Touch Screen	<b>** For right-angle, add RA to the middle of the model number (example, MQDEC-8005RA-USB)</b>
<b>Used with:</b> BCR Plus only						

Additional cordset information is available. See page 758



**SMBIVURAL    SMBIVURAR    SMBIVUB    SMBIVUU**  
**Used with:** iVu BCR and iVu Plus BCR

Additional bracket information is available. See page 726

For more specifications see page 277.

Display and cordsets ordered separately.  
 Remote display is required for set up and viewing of sensors with a remote touch screen.



Remote Display Touch Screen

Description	Model
3.5" diagonal remote touch screen — Machine-mountable	RDM35
3.5" diagonal remote touch screen — Handheld	RD35

RDM35 Accessory Kits



**RDM35**  
Machine-mountable Remote Display  
Used for- programming & monitoring

Description	Straight	Right-Angle
1 m cordset, bracket/docking station, stylus and hardware	IVURDM-QDK-803	IVURDM-QDK-803RA
2 m cordset, bracket/docking station, stylus and hardware	IVURDM-QDK-806	IVURDM-QDK-806RA
5 m cordset, bracket/docking station, stylus and hardware	IVURDM-QDK-815	IVURDM-QDK-815RA
9 m cordset, bracket/docking station, stylus and hardware	IVURDM-QDK-830	IVURDM-QDK-830RA
16 m cordset, bracket/docking station, stylus and hardware	IVURDM-QDK-850	IVURDM-QDK-850RA

RD35 Accessory Kits



**RD35**  
Handheld Remote Display  
Used for- programming

Description	Straight	Right-Angle
1 m cordset, bracket/docking station, stylus and hardware	IVURD-MXK-803	IVURD-MXK-803RA
2 m cordset, bracket/docking station, stylus and hardware	IVURD-MXK-806	IVURD-MXK-806RA
5 m cordset, bracket/docking station, stylus and hardware	IVURD-MXK-815	IVURD-MXK-815RA
9 m cordset, bracket/docking station, stylus and hardware	IVURD-MXK-830	IVURD-MXK-830RA
16 m cordset, bracket/docking station, stylus and hardware	IVURD-MXK-850	IVURD-MXK-850RA

Cordsets for Remote Display

Hand Held Remote Display (RD35)

8-Pin
<b>Double Ended M12/Euro-Style</b> Straight connector models listed; for right-angle, add <b>RA</b> to the end of the model number (example, <b>IVURD-QD-803RA</b> )
<b>IVURD-QD-803</b> 1 m (3')
<b>IVURD-QD-806</b> 2 m (6')
<b>IVURD-QD-815</b> 5 m (15')
<b>IVURD-QD-830</b> 9 m (30')
<b>IVURD-QD-850</b> 16 m (50')

Machine Mountable Remote Display (RDM35)

8-Pin
<b>Euro-Style to Molex</b> Straight connector models listed; for right-angle, add <b>RA</b> to the end of the model number (example, <b>IVURD-MX-803RA</b> )
<b>IVURD-MX-803</b> 1 m (3')
<b>IVURD-MX-806</b> 2 m (6')
<b>IVURD-MX-815</b> 5 m (15')
<b>IVURD-MX-830</b> 9 m (30')
<b>IVURD-MX-850</b> 16 m (50')

Additional cordset information is available  
See page 773

Brackets for Remote Display



SMBRD35



SMBKS



SMBRDM35

Lenses



Lens	Model
4.3 mm	LMF04
6 mm	LMF06
8 mm	LMF08
12 mm	LMF12
16 mm	LMF16
25 mm	LMF25*

Used with: iVu and iVu Plus

\* 25 mm filter holder is purchased separately

Filter Kits†



Used with: iVu and iVu Plus

\* Blue band-pass filters are preinstalled on ultraviolet ringlight models  
 \*\* Infrared band-pass filters are preinstalled on infrared ring light models  
 † Filter kits include 1 color and two sizes of filter holders

Filter Model

Red	FLTMR2
Blue	FLTMB*
Green	FLTMG
Infrared	FLTMI**

Replacement Windows

Focusing ring with optically clear glass  
 Focusing ring with plastic window  
 Replacement cover for touch screen

Model

IVUW-G
IVUW
IVUBC

Used with: iVu and iVu Plus

Sensor Interface Module



**IVUSIM**  
 For simplified wiring of iVu sensors in an electrical box

2 GB USB Drive



IVU-USBFD2

Stylus



Model

STYLUS-1 (Qty 1)
STYLUS-10 (Qty 10)

C-Mount Lens Covers



Description	Model
Lens cover 50 mm — plastic window	IVUSLC50-P
Lens cover 75 mm — plastic window	IVUSLC75-P



Additional C-mount Lens information is available  
 See page 362

Accessories for C-Mount Lenses\*

Description	Format Size	Model	Used With
Extension Kit (0.5, 1.0, 5.0, 10, 20 and 40 mm)	—	LEK	All Lenses
Extension Kit (0.25 and 0.5 mm)		LEKS	
Lens Extender (increases focal length 2X)		LCF2X	
UV Lens Filter, Clear Glass	2/3"	FLTUV	Tamron Megapixel Lenses



Bandpass Filters

Example Model Number: FLTB470-27

Description	Model	Diameter
Blue	FLTB470-	25.5
Green	FLTG525-	
Infrared	FLTI850-	27
Red	FLTR635-	30.5
Dark Red	FLTR660-	34
Polarizing Filter	FLTPR032-	43

C-Mount Color Filters\*



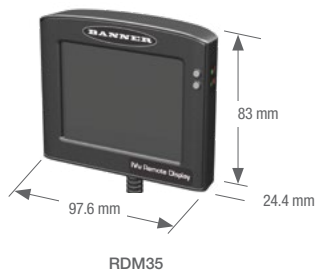

Color	Description	Plastic Models	Glass Models
Infrared	High-pass filter blocks visible light and passes infrared light. Included with all Banner Infrared light sources.	FLTI (> 760 nm)	FLTI850 (810-990 nm)
Blue	Band-pass filter improves quality by helping to reduce ambient light; it passes blue and infrared light.	FLTB (400-525 nm)	FLTB470 (435-490 nm)
Green	Band-pass filter improves quality by helping to reduce ambient light; it passes green and infrared light.	FLTG (400-575 nm)	FLTG525 (495-565 nm)
Red	High-pass filter improves quality by helping to reduce ambient light; it passes red and infrared light.	FLTR (> 600 nm)	FLTR635 (600-660 nm)
Dark Red	High-pass filter improves quality by helping to reduce ambient light; it passes red and infrared light.	—	FLTR660 (650-680 nm)

\* For C-Mount lenses see page 362



## iVu BCR &amp; iVu Plus BCR Specifications

General	
Supply Voltage	10-30 V dc
Demo Mode	Full tool functionality on canned images
Sensor Lock	Optional password protection
Integrated Ring Light	Red, IR, Green, Blue, White, UV or no integrated ring light
Imager	1/3 inch CMOS 752 x 480 pixels; adjustable Field-of-View (FOV)
Lens Mount	M12 X 1 mm thread (c-mount lens); microvideo lens 4.3, 6, 8, 12, 16, 25 mm
Output Rating	150 mA
Exposure Time	0.1 milliseconds to 1.049 seconds
Construction	Black PBT sensor housing; acrylic window <b>iVu Plus Integrated:</b> Die cast zinc and Black PBT
External Strobe Output	+ 5 V dc
Environmental Rating	IP67
Model Specific	
Power Connection	<b>iVu BCR</b> (integrated and remote touch screen): 12-pin Euro-style (M12) male connector <b>iVu Plus BCR</b> (integrated and remote touch screen): 12-pin Euro-style (M12) male connector Accessory cordset required for operation; QD cordsets are ordered separately.
Supply Current	<b>iVu BCR:</b> 800 mA max. (exclusive of I/O load) <b>iVu Plus BCR:</b> 850 mA max. (exclusive of I/O load)
USB 2.0 Host	<b>iVu BCR</b> (integrated touch screen): 8-pin Euro-style (M12) female connector <b>iVu BCR</b> (remote touch screen): 4-pin Pico-style (M8) female connector <b>iVu Plus BCR</b> (integrated and remote touch screen): 4-pin Pico-style (M8) female connector Optional USB cordset required for operation of USB Thumb Drive. QD cordsets are ordered separately. See page 274.
Ethernet Connection	<b>iVu Plus BCR:</b> 4-pin Pico-style (M8) male connector. Ethernet cordsets are ordered separately. See page 274
Output Configuration	NPN or PNP, software selectable
Display	<b>Integrated touch screen:</b> 68.5 mm (2.7") LCD Color Integrated Display 320 x 240 pixels <b>Remote touch screen:</b> See RD35 Remote Display specifications
Acquisition	<b>iVu BCR</b> (integrated touch screen): 50 fps (frames per second) max. <b>iVu Plus BCR</b> (integrated and remote touch screen): 100 fps (frames per second) max. <b>iVu BCR</b> (remote touch screen): 50 fps (frames per second) max.
Operating conditions	<b>Stable Ambient Temperature:</b> <b>BCR:</b> 0 to + 50 °C <b>iVu Plus BCR</b> (integrated touch screen): 0 to +45 °C <b>iVu Plus BCR</b> (remote touch screen): 0 to +40 °C
Remote Display connection (Remote Touch Screen Models Only)	8-pin Euro-style (M12) female connector Accessory cordset required for remote display; QD cordsets are ordered separately.
Certifications	 <b>NOTE:</b> iVu Plus remote must use Euro QD power cordset for CE compliance. 

## iVu Remote Display Specifications

Screen Size	3.5" diagonal
LCD Aspect Ratio	4:3
Display Resolution	320 x 240 RGB
Viewing Angle	60 degrees left, and 60 degrees right, 50 degrees up, and 55 degrees down
Housing Material	Zinc Zamac #3
Bracket Material	Delrin
Stylus	Delrin
Display Weight	4.8 oz
Bracket & Stylus Weight	1.1 oz
Connection	Molex HandyLink connector
Operating Temperature	0 to + 50 °C

# P4 BCR

## Bar Code Reader



- P4 Bar Code Readers find and decode 2D and 1D linear bar codes.
- Industry-standard bar code metrics and grading
- Economical one-piece solution
- High performance vision inspections in self-contained in-line or right-angle housing styles that fit in the palm of your hand

Conducts high-performance reading of industry standard barcodes.

**2D Bar Codes**  
Data Matrix (ECC200)  
QR & Micro QR

**1D Bar Codes**  
Code 128  
Code 39  
Codabar  
Interleaved 2 of 5

EAN-13 (UPC-A)  
EAN-8  
UPC-E  
IMB

Postnet  
Pharmacode

### Choosing a P4 BCR

Example Model Number P4BCR



Right-Angle Sensor Models  
(shown with lens—sold separately)



In-line Sensor Models  
(shown with lens—sold separately)

\* To add the OCR/OCV premium tool add suffix -OC to the model number. (example P4BCR-OC)

Power and I/O Cable	12-Pin	Video (BNC to BNC)	Ethernet	Shielded	Shielded Crossover	
Hirose with 12 flying leads	<b>P4C06</b> 2 m (6.5') <b>P4C23</b> 7 m (23') <b>P4C32</b> 10 m (32')	<b>P4C50</b> 15 m (49') <b>P4C75</b> 23 m (75') <b>P4C110</b> 34 m (111')	Coaxial with male BNC both ends	<b>BNC06</b> 2 m (6.5') <b>BNC15</b> 5 m (15') <b>BNC30</b> 9 m (30') <b>BNC48</b> 15 m (49')	Straight RJ45 to RJ45 Cable length: 2 m <b>STP07</b> 2 m (6.5') <b>STP25</b> 7 m (25') <b>STP50</b> 9 m (30') <b>STP75</b> 22 m (30')	<b>STPX07</b> 2 m (6.5') <b>STPX25</b> 7 m (25') <b>STPX50</b> 9 m (30') <b>STPX75</b> 22 m (30')

Additional cordset information is available  
See page 758

### PresencePLUS® P4 Dedicated-Function Specifications

Supply Voltage and Current	10 to 30 V dc (24 V dc $\pm$ 10% if the sensor powers a light source) <b>P4BCR</b> : Less than 650 mA (exclusive of lights and I/O load) <b>P4BCR 1.3</b> : Less than 550 mA (exclusive of lights and I/O load)	
Memory (Storage)	<b>BCR—8 MB Inspection (jobs)</b> : 999 max.	<b>BCR 1.3—32 MB Inspection (jobs)</b> : 999 max.
Input/Output Configuration	NPN (sinking) or PNP (sourcing) software selectable	
Output Rating	150 mA max. each output <b>OFF-state leakage current</b> : less than 100 $\mu$ A <b>ON-state saturation voltage</b> : NPN—less than 1 V @ 150 mA max. PNP—greater than V+ -2 V	
Bicolor Status Indicators	<b>PASS/FAIL</b> : Green ON steady—PASS Red ON steady—FAIL <b>POWER/ERROR</b> : Green ON steady—POWER Red ON steady—ERROR <b>READY/TRIGGER</b> : Green ON steady—READY Yellow ON steady—TRIGGER	
Display Options	PC or NTSC video (uses 9 m max. BNC cordset)	
Discrete I/O	1 Trigger IN 1 Strobe OUT 4 Programmable I/O 1 Product Change IN 1 Remote TEACH IN	
Communications	RJ-45 10/100 Ethernet connection for running PresencePLUS P4 software and/or output inspection results RS-232 connection for output of inspection results	
Imager Resolution	<b>BCR</b> : 640 x 480 pixels	<b>BCR 1.3</b> : 1280 x 1024 pixels
Pixel Size	<b>BCR</b> : 7.4 x 7.4 $\mu$ m	<b>BCR 1.3</b> : 6.7 x 6.7 $\mu$ m
Imager Size	<b>BCR</b> : 4.8 x 3.6 mm, 6 mm diagonal (1/3 inch CCD)	<b>BCR 1.3</b> : 8.6 x 6.9 mm, 11 mm diagonal (2/3 inch CMOS)
Levels of Gray	256 Gray Scale	
Exposure Time	<b>BCR</b> : 0.1 to 2830 milliseconds	<b>BCR 1.3</b> : 0.1 to 1670 milliseconds
Full Image Acquisition	<b>BCR</b> : 48 frames per second max.*	<b>BCR 1.3</b> : 27 frames per second max.*
Lens Mount	Standard C-mount (1 inch—32 UN)	
Construction	Black anodized aluminum housing, glass lens	
Weight	<b>In-line</b> : 293 g	<b>Right-angle</b> : 385 g
Environmental Rating	IEC IP20; NEMA 1	
Operating Temperature	<b>Stable ambient temperature</b> : 0 to +50 °C <b>Stable ambient lighting</b> : No large, quick changes in light level; no direct or reflected sunlight <b>Relative humidity</b> : 90% (non-condensing)	
Certifications		

\* A reduced Field-of-View (FOV) dramatically increases acquisition rates.

# Barcode Scanner

## Laser Barcode Scanner



- The TCNM can detect over a dozen of the most commonly used linear barcode symbols with a fast reading rate
- Advanced algorithm and multiple scans can reconstruct damaged codes
- Has a barcode reading range of up to 600 mm
- Rugged, IP65-rated industrial housing
- SMART TEACH push button programming



**Correct Label Verification**  
Lot control and traceability for a pharmaceutical manufacturer

### Barcode Scanner, 10-30 V DC

Visible Red Laser

Sensing Mode	Range	Resolution	Laser Output	Models
Class 2 laser	40-300 mm	Standard resolution: 8-20 mils	Single line scan	TCNM-AD-1200
	50-310 mm	High performance: 6-20 mils		TCNM-AD-1204
	30-90 mm	High resolution: 6-12 mils		TCNM-AD-2200
	45-100 mm	High resolution, High performance 5-8 mils		TCNM-AD-2204
Class 2 laser	40-300 mm	Standard resolution: 8-20 mils	Ten line raster scan	TCNM-AD-1210
	50-310 mm	High performance: 6-20 mils		TCNM-AD-1214
	30-90 mm	High resolution: 6-12 mils		TCNM-AD-2210
	45-100 mm	High resolution, High performance 5-8 mils		TCNM-AD-2214
Class 2 laser	75-340 mm	Short range: 8-14 mils	Single line scan	TCNM-EX-0200
	100-440 mm	Medium range: 10-20 mils		TCNM-EX-1200
	190-600 mm	Long range: 14-20 mils		TCNM-EX-2200
Class 2 laser	75-340 mm	Short range: 8-14 mils	Ten line raster scan	TCNM-EX-0210
	100-440 mm	Medium range: 10-20 mils		TCNM-EX-1210
	190-600 mm	Long range: 14-20 mils		TCNM-EX-2210

**Conducts high-performance reading of industry standard barcodes.**

- |                    |                      |
|--------------------|----------------------|
| Code 128           | Postnet              |
| Code 39            | Pharmacode           |
| Codabar            | GS1 DataBar          |
| Interleaved 2 of 5 | GS1 DataBar Expanded |
| EAN-13 (UPC-A)     | GS1 DataBar Limited  |
| EAN-8              |                      |
| UPC-E              |                      |
| IMB                |                      |



## Accessories



**TCNM-AD-CAB**  
Serial interface adapter (RS232 or RS-485) going from TCNM-ACBB1 to PC (DB9)



**TCNM-ACBB1**  
Connection box



## Barcode Scanner Specifications

Supply Voltage and Current	10 to 30 V dc Maximum 0.5 to 0.17 A; 5 W
Input/Output Configuration	<b>Input 1 (External Trigger), Input 2:</b> Optocoupled, polarity insensitive
Reading Features	<b>Scan Rate (software):</b> (600 to 1000 scans/sec) <b>Aperture Angle:</b> 50°
Construction	Black anodized aluminum housing, glass lens
Weight	330 g
Environmental Rating	IP65
Operating Temperature	<b>Operating temperature:</b> 0 to +45 °C <b>Storage temperature:</b> -20 to +70 °C <b>Relative humidity:</b> 90% (non-condensing)
Hookup Diagrams	See data sheet for more information



## Registration, Color & Luminescence

Registration mark sensors reliably detect registration marks in low contrast applications. True color sensors analyze colors and reliably detect registration marks in extremely low contrast applications. These sensors can detect changes in color and intensity of targets of the same color. Luminescence sensors detect luminescent marks even on irregular or reflective backgrounds.

Series	Description	Max Sensing Range	Dimensions H x W x D	Protection Rating	Housing Material	Power Supply
	<b>QC50/QCX50</b> Accurately analyze and compare colors or varying intensities of color. page 284	Diffuse: 20 mm	50 x 25 x 50 mm	IEC IP62	ABS	10 to 30 V dc
	<b>Q26</b> Reliably detects luminescent plastics, coatings, lubricants, and other targets on even and uneven surfaces page 286	Diffuse: 30 mm	14 x 25 x 42 mm	IEC IP67	ABS	12 to 30 V dc
	<b>QL56</b> Detects luminescent marks, even on luminescent backgrounds, and reflective surfaces such as ceramic, metal or mirrored glass. page 288	Diffuse: 50 mm	96.5 x 31.9 x 65.5 mm	IEC IP67	Aluminum	15 to 30 V dc
	<b>R58</b> Registration mark sensors that detect contrasts as low as 2% over a wide range of colors. page 290	Convergent: 10 mm	62.1 x 30 x 83.3 mm	IEC IP67	Zinc alloy	10 to 30 V dc
	<b>R55</b> Delivers outstanding color contrast sensitivity and features an innovative TEACH function for setting the sensing threshold. page 294	Varies depending on fiber	85.4 x 30 x 25 mm	IEC IP67; NEMA 6	ABS/polycarbonate blend	10 to 30 V dc

# QC50/QCX50 Series

## True Color Sensors



- The QC50 and QCX50 accurately analyze and compare colors or varying intensities of color. The QC50 will solve most color comparison applications and for challenging applications such as reading the difference between dark blue and black use the QCX50.
- Offers easy-to-set push-button programming options for up to three colors
- Compact, self-contained design
- Offers fast response time of 335 microseconds, depending on model

### QC50, 10-30 V DC

Visible White LED

Sensing Mode	Range	Connection	Response Time	Output Type	Models
 DIFFUSE	20 mm typical; varies according to sensor configuration	8-pin Euro QD	335 $\mu$ s	NPN, 3 channels	QC50A3N6XDWQ
				PNP, 3 channels	QC50A3P6XDWQ

### QCX50, 10-30 V DC

Visible White LED

Sensing Mode	Range	Connection	Response Time	Output Type	Models
 DIFFUSE	20 mm typical; varies according to sensor configuration	8-pin Euro QD	Selectable 5 ms or 1 ms	NPN, 3 channels	QCX50A3N6XDWQ
				PNP, 3 channels	QCX50A3P6XDWQ

Connection options: A model with a QD requires a mating cordset.

**Euro-Style**

Straight connector models listed; for right-angle, add **RA** to the end of the model number (example, **MQDC2S-806RA**)

**MQDC2S-806**  
2 m (6.5')  
**MQDC2S-815**  
5 m (15')  
**MQDC2S-830**  
9 m (30')

**SMBQC50**

Additional cordset information is available  
See page 758

Additional bracket information is available  
See page 725



## QC50/QCX50 Specifications

<b>Sensing Receiver</b>	Solid-state photodiode device with R, G, B filters
<b>Minimum Spot Diameter</b>	4 mm
<b>Supply Voltage and Current</b>	10 to 30 V dc, 2 V pp max ripple 40 mA max @ 24 V dc (excluding output current)
<b>Supply Protection Circuitry</b>	Protected against reverse polarity, over-voltage, and transient voltage
<b>Output Configuration</b>	3 PNP or 3 NPN outputs, depending on model 30 V dc max. Saturation voltage: less than 2 V
<b>Output Rating</b>	100 mA max. load per output channel
<b>Output Protection Circuitry</b>	Protected against output short-circuit, continuous overload, transient over-voltages, and false pulse on power-up
<b>Output Response Time</b>	<b>QC50 models:</b> 335 microseconds <b>QCX50 models:</b> Selectable 5 milliseconds (normal) or 1 millisecond <b>QC50 models</b> <b>QCX50 models</b> <b>Gate ON-time:</b> 335 microseconds      700 microseconds <b>Gate OFF-time:</b> 170 microseconds      400 microseconds
<b>Delay at Power-up</b>	500 milliseconds; outputs do not conduct during this time
<b>Data Retention</b>	EEPROM nonvolatile memory
<b>Ambient Light Rejection</b>	According to EN 609475-2
<b>Adjustments</b>	2 push buttons (Set and Select) • Color, scanning, color modes, delay and tolerance • Manual adjustment of color channels, sensing mode and tolerance level
<b>Indicators</b>	4-Digit LCD Display: indicates sensing mode, run status, tolerance level, output status Yellow Output LED: ON when any output is conducting 3 Green Channel Output Status LEDs: ON when its corresponding output is conducting
<b>Construction</b>	ABS shock-resistant housing; glass window and lens
<b>Environmental Rating</b>	IEC IP67
<b>Operating Conditions</b>	<b>Temperature:</b> -10 to +55 °C <b>Relative humidity:</b> 90% at 50 °C (non-condensing)
<b>Shock Resistance</b>	Approx. 30 G; 3 shocks per axis; 11 milliseconds duration
<b>Vibration</b>	0.5 mm amplitude; 10 to 60 Hz frequency; 30 minutes for each X, Y, Z axis
<b>Certifications</b>	

# Q26 Series

## Luminescence Sensor



- Reliably detects luminescent plastics, coatings, lubricants, and other targets on even and uneven surfaces
- Simple configuration with the push button on the sensor's housing or via a remote input line
- Rotary switch selects Light Operate or Dark Operate
- IP67-rated housing for use in rugged industrial environments
- Compact housing size

### Q26, 12-30 V DC

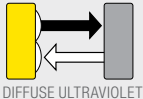
Sensing Mode	Range	Connection	Models NPN	Models PNP
 DIFFUSE ULTRAVIOLET	10 to 30 mm	4-pin M12/Euro-style quick disconnect fitting on a 150 mm (6 in) PVC cable jacket	Q26NLUMQ5	Q26PLUMQ5



Connection options: A model with a QD requires a mating cordset.

For a 9 m cable, add suffix W/30 to the 2 m model number (example, Q26NXLQ7 W/30)



**Euro-Style Cordsets**  
 Straight connector models listed;  
 for right-angle, add **RA** to the end  
 of the model number (example,  
**MQDC-406RA**)

**4-Pin**  
**MQDC-406**  
 2 m (6.5')  
**MQDC-415**  
 5 m (15')  
**MQDC-430**  
 9 m (30')

*Additional cordset information is available  
 See page 758*



**SMBLSTDLQ26**



**SMBLSTQ26**

*Additional bracket information is available  
 See page 725*



**Q26 Specifications**

<b>Supply Voltage and Current</b>	12 to 30 V dc (2 Vpp maximum ripple) <b>Supply current (exclusive of load current):</b> 30 mA
<b>Supply Protection Circuitry</b>	Protected against reverse polarity and transient voltages
<b>Output Configuration</b>	NPN or PNP
<b>Output Rating</b>	100 mA max (exclusive of load) <b>ON-state saturation voltage:</b> less than 2 V @ 10 mA dc; less than 1.5 V @ 150 mA dc
<b>Output Protection Circuitry</b>	Protected against false power-up and continuous overload or short circuit of outputs
<b>Output Response Time</b>	250 μS or 1 ms (based on sensitivity)
<b>Indicators</b>	<b>Green ON:</b> Power ON <b>Amber ON:</b> Output conducting
<b>Construction</b>	ABS plastic housing, glass window, polycarbonate lens
<b>Operating Conditions</b>	<b>Temperature:</b> -10 to +55 °C <b>Relative Humidity:</b> 90% at 50°; non-condensing
<b>Environmental Rating</b>	IEC IP67
<b>Vibration and Shock</b>	EN60068-2-6 and EN60068-2-27

**Certifications**





# QL56 Series

## Luminescence Sensors



- The Q25 sensor is completely epoxy-encapsulated for use in harsh sensing environments, including food and beverage applications.
- Compact, self-contained design
- Includes easy-to-set programming options
- High-speed response of 250 microseconds

QL56, 15-30 V DC

➔ Black Ultraviolet LED

⇐ Returned Luminescence

Sensing Mode	Range	Connection	Output Type	Models
DIFFUSE	10-20 mm	5-pin Euro QD	Bipolar NPN/PNP plus one 0.75-5.5 V dc analog	QL56M6XD15BQ
DIFFUSE	20-40 mm	5-pin Euro QD	Bipolar NPN/PNP plus one 0.75-5.5 V dc analog	QL56M6XD30BQ
DIFFUSE	30-50 mm	5-pin Euro QD	Bipolar NPN/PNP plus one 0.75-5.5 V dc analog	QL56M6XD40BQ

Connection options: A model with a QD requires a mating cordset.



QL56M6XD30BQ Models



QL56M6XD15BQ Models



QL56M6XD40BQ Models



## 5-Pin

## Euro-Style

Straight connector models listed; for right-angle, add **RA** to the end of the model number (example, **MQDC1-506RA**)

**MQDC1-506**

2 m (6.5')

**MQDC1-515**

5 m (15')

**MQDC1-530**

9 m (30')



SMB55A



SMB55RA



SMB55F



SMB55S

Additional cordset information is available  
See page 758

Additional bracket information is available  
See page 725

## QL56 Specifications

Sensing Beam	LED UV, 375 nm; class 1
Supply Voltage and Current	15 to 30 V dc, (2 V pp max ripple); 50 mA max @ 24 V dc (excluding output current)
Supply Protection Circuitry	Protected against reverse polarity
Output Configuration	Bipolar (1 NPN & 1 PNP), plus 0.75 to 5.5 V dc analog output
Analog Output	0.75 to 5.5 V dc max
Analog Output Impedance	2.2 k $\Omega$ (short-circuit protection)
Output Rating	100 mA max.
Output Saturation Voltage	< 2 V
Output Protection Circuitry	Overload and short circuit protection
Output Response Time	250 microseconds
Ambient Light Rejection	According to EN 60947-5-2
Adjustments	"+" and "-" push buttons determine sensitivity "Set" push button activates delay and keylock function
Switching Frequency	2 kHz
Delay at Power-up	0 milliseconds (default) or 20 milliseconds user selectable
Indicators	<b>Green Ready LED:</b> ON indicates power on; Flashing indicates output overload <b>Yellow Output LED:</b> ON indicates output conducting <b>Orange Delay LED:</b> ON indicates 20 milliseconds delay activated <b>Orange Keylock LED:</b> ON indicates push buttons are unlocked <b>5-segment bar graph:</b> Indicates sensitivity
Construction	Aluminum housing, glass lens; mass 180 g. max.
Environmental Rating	IP67
Operating Conditions	<b>Temperature:</b> -10 to +55 °C <b>Storage Temperature:</b> -20 to 70 °C
Minimum Spot Dimensions	2 x 8 mm @ 10 mm ( <b>QL56M6XD15BQ</b> ) 3 x 11 mm @ 24 mm ( <b>QL56M6XD30BQ</b> ) 4 x 15 mm @ 50 mm ( <b>QL56M6XD40BQ</b> )
Shock Resistance	30 G; 6 shocks per axis; 11 milliseconds duration (EN60068-2-27)
Vibration	0.5 mm amplitude; 10 to 55 Hz frequency; per axis (EN60068-2-6)
Application Notes	The lens must be used in the lower position, and the cap must remain in place on the end position
Certifications	

# R58 Expert™ Series

## Registration Mark Sensors



- The R58E sensors offer maintenance-free, solid-state reliability for color contrast applications. With a fast, 50-microsecond sensing response time, the R58E provides excellent registration repeatability, even in speedy applications.
- Bipolar outputs
- 10,000 actuations per second and 15 microsecond repeatability
- Rugged mechanical housing rated to IP67

R58 Expert™, 10-30 V DC

 Visible Red, Green or Blue LED, depending on registration mark

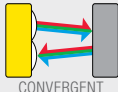
Sensing Mode/LED	Focus	Connection	Output Type	Models	
				Parallel	Perpendicular
 CONVERGENT	10 mm	2 m	Bipolar NPN/PNP	R58ECRGB1	R58ECRGB2
		5-pin Euro Pigtail QD	Bipolar NPN/PNP	R58ECRGB1Q	R58ECRGB2Q
		2 m	PNP	R58BPCRGB1	R58BPCRGB2
		5-pin Euro Pigtail QD	PNP	R58BPCRGB1Q	R58BPCRGB2Q
		2 m	NPN	R58BNCRGB1	R58BNCRGB2
		5-pin Euro Pigtail QD	NPN	R58BNCRGB1Q	R58BNCRGB2Q

For more specifications see page 293.

 Connection options: A model with a QD requires a mating cordset (see page 292)

For 9 m cable, add suffix W/30 to the 2 m model number (example, R58ECRGB1 W/30).

QD models: For integral 5-pin Euro-style QD, add suffix Q8 to the 2 m model number (example R58ECRGB1Q8).

# R58A Series

## Registration Mark Sensors



- Easy to set multi-turn potentiometer
- The R58A provides outstanding color contrast sensitivity in low-contrast or high-gloss applications and detects contrasts as low as 2% over a wide range of colors
- Bipolar outputs
- Provides a single emitter color of red or green, depending on model
- Rugged mechanical housing rated to IP67

R58A Expert™, 10-30 V DC

➔ Visible Red LED    ➔ Visible Green LED

Sensing Mode/LED	Focus	Connection	Output Type	OFF-Delay	Models	
					Parallel	Perpendicular
 CONVERGENT	10 mm	2 m	Bipolar NPN/ PNP	0 ms	R58ACG1	R58ACG2
		4-pin Euro Pigtail QD			R58ACG1Q	R58ACG2Q
		2 m			R58ACG1D	R58ACG2D
		4-pin Euro Pigtail QD			R58ACG1DQ	R58ACG2DQ
 CONVERGENT	10 mm	2 m	Bipolar NPN/ PNP	0 ms	R58ACR1	R58ACR2
		4-pin Euro Pigtail QD			R58ACR1Q	R58ACR2Q
		2 m			R58ACR1D	R58ACR2D
		4-pin Euro Pigtail QD			R58ACR1DQ	R58ACR2DQ

For more specifications see page 293.

➔ Connection options: A model with a QD requires a mating cordset (see page 292)

For 9 m cable, add suffix W/30 to the 2 m model number (example, R58ACG1 W/30).

QD models: For integral 4-pin Euro-style QD, add suffix Q8 to the 2 m model number (example, R58ACG1Q8).



**Euro-Style**  
Straight connector models listed; for right-angle, add **RA** to the end of the model number (example, **MQDEC2-506RA**)

**Used with:** Expert models

**MQDEC2-506**  
2 m (6.5')  
**MQDEC2-515**  
5 m (15')  
**MQDEC2-530**  
9 m (30')



4-Pin

**Euro-Style Cordsets**  
Straight connector models listed; for right-angle, add **RA** to the end of the model number (example, **MQDC-406RA**)

**Used with:** R58A models

**MQDC-406**  
2 m (6.5')  
**MQDC-415**  
5 m (15')  
**MQDC-430**  
9 m (30')

Additional cordset information is available  
See page 758



SMB55A



SMB55RA



SMB55F



SMB55S

Additional bracket information is available  
See page 725



R58 Expert



R58B



R58A

## R58 Specifications

Supply Voltage and Current	10 to 30 V dc (10% max. ripple) <b>R58A:</b> 36 mA exclusive of load <b>R58B &amp; R58E:</b> 75 mA @ 10 V dc 35 mA @ 30 V dc
Supply Protection Circuitry	Protected against reverse polarity and transient voltages
Output Configuration	<b>R58 Expert &amp; R58A:</b> Bipolar: One current sourcing (PNP) and one current sinking (NPN) <b>R58B:</b> Single output: One current sourcing (PNP) or one current sinking (NPN)
Output Rating	<b>R58 Expert &amp; R58B:</b> 100 mA max. (each output) OFF-state leakage current: NPN less than 200 $\mu$ A; PNP less than 10 $\mu$ A NPN saturation: less than 1.6 V @ 100 mA PNP saturation: less than 3 V @ 100 mA <b>R58A:</b> 150 mA max. (each output) OFF-state leakage current: less than 10 $\mu$ A NPN saturation: less than 200 mV @ 10 mA and less than 1 V @ 150 mA PNP saturation: less than 1 V @ 10 mA and less than 2 V @ 150 mA
Output Protection Circuitry	Protected against false pulse on power-up and continuous overload or short-circuit of outputs
Output Response Time	50 microseconds
Delay at Power-up	<b>R58A:</b> 100 milliseconds; outputs do not conduct during this time <b>R58B &amp; R58E:</b> 1 second; outputs do not conduct during this time
Repeatability	15 microseconds
Sensing Image	Rectangular: 1.2 x 3.8 mm at 10 mm from face of lens; image oriented either parallel or perpendicular to sensor length, depending on model
Adjustments	<b>R58 Expert &amp; R58B:</b> 2 push buttons and remote wire for sensor TEACH programming and configuration. See datasheet for detailed information. <b>R58A:</b> Light/Dark Operate (LO/DO) select switch, and 15-turn switchpoint adjustment potentiometer
Indicators	<b>R58 Expert: 8-segment Bargraph display:</b> <b>Green:</b> Power ON <b>Yellow:</b> Outputs ON <b>2-position Green:</b> LED ON next to DO for Dark Operate LED ON next to LO for Light Operate <b>2-position Green:</b> LED ON next to ON for ON-delay LED ON next to OFF for OFF-delay <b>R58B: Green:</b> Power ON <b>Amber:</b> Output active <b>R58A: Amber:</b> Output active <b>Green:</b> Switchpoint threshold adjustment indicators See datasheet for detailed information.
Construction	Zinc alloy die-cast housing with black painted finish and o-ring sealed lens port cap <b>Lens:</b> Acrylic <b>Lens port cap and lens holder:</b> ABS <b>Sensitivity and LO/DO adjusters:</b> Acetal <b>QD:</b> Anodized aluminum
Environmental Rating	IEC IP67
Operating Conditions	<b>Temperature: R58E:</b> -10 to +50 °C <b>R58A &amp; R58B:</b> -10 to +55 °C <b>Relative humidity:</b> 90% at 50 °C (non-condensing) <b>Storage temperature:</b> -20 to +80 °C
Shock and Vibration	All models meet IEC 68-2-6 and IEC 68-2-27 testing criteria
Certification	

# R55F Series

## Fiber Optic Sensors



- Reliably detects 16 levels of grayscale at up to 10,000 actuations per second
- 10,000 actuations per second and 15 microsecond repeatability
- Bipolar outputs

### R55F Fiber Optic, 10-30 V DC



Sensing Mode	Range	Connection	Output Type	Models
	Range varies by sensing mode and fiber optics used	2 m 5-pin Euro QD	Bipolar NPN/PNP	R55F R55FQ
	Range varies by sensing mode and fiber optics used	2 m 5-pin Euro QD	Bipolar NPN/PNP	R55FV R55FVQ
	Range varies by sensing mode and fiber optics used	2 m 5-pin Euro QD	Bipolar NPN/PNP	R55FVG R55FVGQ
	Range varies by sensing mode and fiber optics used	2 m 5-pin Euro QD	Bipolar NPN/PNP	R55FVB R55FVBQ
	Range varies by sensing mode and fiber optics used	2 m 5-pin Euro QD	Bipolar NPN/PNP	R55FVW R55FVWQ
	Range varies by sensing mode and fiber optics used	2 m 5-pin Euro QD	Bipolar NPN/PNP	R55FP R55FPQ
	Range varies by sensing mode and fiber optics used	2 m 5-pin Euro QD	Bipolar NPN/PNP	R55FPG R55FPGQ
	Range varies by sensing mode and fiber optics used	2 m 5-pin Euro QD	Bipolar NPN/PNP	R55FPB R55FPBQ
	Range varies by sensing mode and fiber optics used	2 m 5-pin Euro QD	Bipolar NPN/PNP	R55FPW R55FPWQ

Connection options: A model with a QD requires a mating cordset.

For 9 m cable, add suffix W/30 to the 2 m model number (example, R55F W/30).













---

## Stainless Steel

Stainless steel sensors hold up well in extremely abusive environments and can handle a wide variety of chemicals. This makes them ideal for hygienic applications, such as food and beverage applications.

Series	Description	Max Sensing Range	Dimensions H x W x D	Protection Rating	Power Supply
	<b>QM26</b> The QM26 withstands high-pressure washdown environments and is easy to mount for a hassle-free setup. Page 298	<b>Opposed:</b> 8.5 m <b>Polar Retro:</b> 3 m <b>Coaxial Polar Retro:</b> 2.6 m <b>Background Suppression:</b> 200 mm	48.5 x 14 x 25 mm	IP69K	10-30 V dc
	<b>QMH26</b> The QMH26 is designed with minimal grooves and crevices, making it easy to clean and ideal for clean-in-place (CIP) applications. Page 300	<b>Polar Retro:</b> 3 m <b>Coaxial Polar Retro:</b> 2.6 m <b>Background Suppression:</b> 400 mm <b>Foreground Suppression:</b> 200 mm	53.7 x 14 x 20.3 mm	IP69K	10-30 V dc
	<b>M25U</b> Universal housing design with 18 mm threaded lens; an ideal replacement for hundreds of other sensor styles. Available in eight modes with a compact housing for limited space setups. Page 302	<b>Ultrasonic:</b> 500 mm	103 x ø 25 mm	IP67; NEMA 6, IP69K	10-30 V dc
	<b>SM30</b> Powerful sensor with a long range and the stainless steel model can be used in abusive environments. Page 304	<b>Opposed:</b> 150 m	30 ø x 102 mm	IEC IP67; NEMA 6	10-30 V dc, 2-240 V ac
	<b>VSM Series</b> Heavy-duty metal sensors that are compact and ideal for use in confined areas. Page 306	<b>Opposed:</b> 250 mm <b>Diffuse:</b> 200 mm	Varies by model	IP67; NEMA 6P	10-30 V dc
	<b>M18-4</b> Heavy-duty barrel sensor protected by a 316 stainless steel housing that resists exposure to harsh chemicals and washdown conditions. Page 308	<b>Opposed:</b> 25 m <b>Retro:</b> 7.5 m <b>Polarized Retro:</b> 6 m <b>Diffuse:</b> 750 mm <b>Fixed-Field:</b> 200 mm	18 ø x 63.5 mm	IP67 IP68 IP69K	10-30 V dc

OTHER AVAILABLE MODELS



Q4X page 34

# QM26 Series

## Washdown Sensors



- The QM26 withstands high-pressure washdown environments and is easy to mount for a hassle-free setup
- Rugged, chemically resistant and food safe 316L stainless steel housing
- Reliably detects clear materials in harsh environments
- IP69K rated for use in harsh 1500 psi and 80 °C washdown
- Withstands environmental temperature cycling from -30 to 60 °C

### Opposed QM26

Visible Red LED

Sensing Mode	Range	Connection	Models NPN	Models PNP
 OPPOSED	8.5 m	4-pin Euro QD	QM26EQ5 Emitter	
			QM26VNRQ5	QM26VPRQ5

### Polar Retro QM26

Visible Red LED

Sensing Mode	Range	Connection	Models NPN	Models PNP
 POLAR RETRO	3 m	4-pin Euro QD	QM26VNLPCQ5	QM26VPLPCQ5

### Coaxial Polar Retro QM26

Visible Red LED

Sensing Mode	Range	Connection	Models NPN	Models PNP
 COAXIAL POLAR RETRO	2.6 m	4-pin Euro QD	QM26ENXLPQ5	QM26EPXLPQ5

### Background Suppression QM26

Visible Red LED

Sensing Mode	Range	Connection	Models NPN	Models PNP
 BACKGROUND SUPPRESSION	5-400 mm Cutoff	4-pin Euro QD	QM26VNAF400Q5	QM26VPAF400Q5
	5-200 mm Cutoff (small light spot)	4-pin Euro QD	QM26VNAF200Q5	QM26VPAF200Q5

Connection options: A model with a QD requires a mating cordset.

For a 5 m cable, replace Q5 with -5M to the 2 m model number (example, QM26E-5M)



**Euro-Style**  
Straight connector models listed; for right-angle, add **RA** to the end of the model number (example, **MQDC-406RA**)

4-Pin	5-Pin
<b>MQDC-406</b> 2 m (6.5')	<b>MQDC1-506</b> 2 m (6.5')
<b>MQDC-415</b> 5 m (15')	<b>MQDC1-515</b> 5 m (15')
<b>MQDC-430</b> 9 m (30')	<b>MQDC1-530</b> 9 m (30')

Additional cordset information is available  
See page 758



**SMBLSTDQ26**



**SMBLSTQ26**

Additional bracket information is available  
See page 725

**Reflectors**



Additional information is available  
See page 790

**Apertures**



Additional information is available  
See page 816



**QM26 Specifications**

<b>Supply Voltage and Current</b>	10 to 30 V dc (10% maximum ripple within specified limits); supply current (exclusive of load current) less than 20mA
<b>Supply Protection Circuitry</b>	Protected against reverse polarity and transient voltages
<b>Output Configuration</b>	<b>Most Models:</b> Complementary PNP or NPN by model number
<b>Output Rating</b>	100 mA max <b>OFF-state leakage current for load:</b> NPN less than 200 µA; PNP less than 500 µA <b>ON-state saturation voltage:</b> less than 2 V @ 100 mA
<b>Output Protection Circuitry</b>	Protected against false pulse at power-up and continuous overload or short circuit of outputs
<b>Output Response Time</b>	500 microseconds ON and OFF
<b>Repeatability</b>	<b>Opposed mode:</b> 110 microseconds <b>All other mode:</b> 150 microseconds
<b>Indicators</b>	<b>Green steady:</b> Power ON <b>Yellow steady:</b> Light sensed <b>Yellow flashing:</b> Light sensed but marginal signal
<b>Construction</b>	316L stainless steel housing; acrylic window
<b>Operating Conditions</b>	<b>Temperature:</b> -30 to +70 °C <b>Relative Humidity:</b> Periodic exposure to 100% humidity and washdown cleaning
<b>Environmental Rating</b>	IP67 & IP69K, Ecolab® compatible
<b>Vibration and Shock</b>	IEC60947-5-2

**Certifications**



With Class 2 power

ECOLAB® chemical compatibility pending on some models; contact Banner Engineering for details

# QMH26 Series

## Hygienic Sensors



- The QMH26 is designed with minimal grooves and crevices, making it easy to clean and ideal for clean-in-place (CIP) applications
- Rugged, chemically resistant and food safe 316L stainless steel housing
- Reliably detects clear materials in harsh environments
- IP69K rated for use in harsh 1500 psi and 80° C washdown
- High chemical resistance for the most demanding photoelectric sensing environments

### Polar Retro QMH26

Sensing Mode	Range	Connection	Models NPN	Models PNP
 POLAR RETRO	3 m	4-pin Pico QD	QMH26VNLPQ7	QMH26VPLPQ7

### Coaxial Polar Retro QMH26

Sensing Mode	Range	Connection	Models NPN	Models PNP
 COAXIAL POLAR RETRO	2.6 m	4-pin Pico QD	QMH26ENXLPQ7	QMH26EPXLPQ7

### Background Suppression QMH26

Sensing Mode	Range	Connection	Models NPN	Models PNP
 BACKGROUND SUPPRESSION	Adjustable between 5-400 mm	4-pin Pico QD	QMH26VNAF400Q7	QMH26VPAF400Q7

### Foreground Suppression QMH26

Sensing Mode	Range	Connection	Models NPN	Models PNP
 FOREGROUND SUPPRESSION	Adjustable between 5-200 mm	4-pin Pico QD	QMH26VNAF200Q7	QMH26VPAF200Q7

Connection options: A model with a QD requires a mating cordset.

For a 5 m cable, replace Q7 with -5M in the model number (example, QMH26VNLP-5M)



**Pico QD (for Q models)**  
Straight connector models listed; for right-angle, **W** replaces **G** in the model number.  
(example, **PKW3M-2**)

**4-Pin**  
**PKG4M-2**  
2 m (6')  
**PKG4M-5**  
5 m (15')  
**PKG4M-9**  
9 m (30')

Additional cordset information is available  
See page 758



SMBLSTDLQ26



SMBLSTQ26



SMBQMH26-SS-150

Additional bracket information is available  
See page 725

**Reflectors**



Additional information is available  
See page 790

**Apertures**



Additional information is available  
See page 816

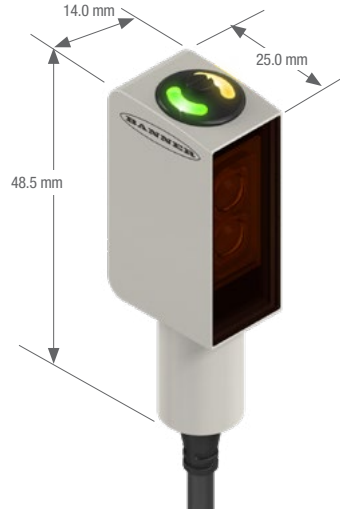

**QMH26 Specifications**

<b>Supply Voltage and Current</b>	10 to 30 V dc (10% maximum ripple within specified limits); supply current (exclusive of load current) less than 20mA
<b>Supply Protection Circuitry</b>	Protected against reverse polarity and transient voltages
<b>Output Configuration</b>	<b>Most Models:</b> Complementary PNP or NPN by model number <b>QMH26E...XLPC models:</b> Single PNP or NPN on pin 4 (black wire) with remote teach input on pin 2 (white wire)
<b>Output Rating</b>	100 mA max <b>OFF-state leakage current for load:</b> NPN less than 200 $\mu$ A; PNP less than 500 $\mu$ A <b>ON-state saturation voltage:</b> less than 2 V @ 100 mA
<b>Output Protection Circuitry</b>	Protected against false pulse at power-up and continuous overload or short circuit of outputs
<b>Output Response Time</b>	500 microseconds ON and OFF
<b>Repeatability</b>	<b>Opposed mode:</b> 110 microseconds <b>All other mode:</b> 150 microseconds
<b>Indicators</b>	<b>Green steady:</b> Power ON <b>Yellow steady:</b> Light sensed <b>Yellow flashing:</b> Light sense but marginal signal
<b>Construction</b>	316L stainless steel housing; acrylic window
<b>Operating Conditions</b>	<b>Temperature:</b> -30 to +70 °C <b>Relative Humidity:</b> Periodic exposure to 100% humidity and washdown cleaning
<b>Environmental Rating</b>	IP67 & IP69K, ECOLAB® compatible
<b>Vibration and Shock</b>	IEC60947-5-2

**Certifications**



With Class 2 power      ECOLAB® chemical compatibility pending on some models; contact Banner Engineering for details



## M25U



## Stainless Steel Ultrasonic Sensors

- Cleans easily with no thread, gaps or seams to trap debris
- The M25U Ultrasonic Sensor features a smooth 316 series stainless steel construction to withstand the toughest sanitary challenges
- Constructed with FDA approved materials and rated to IP69K, IEC IP67 (NEMA 6) with fully encapsulated electronics

## M25U

Range*	Frequency	Connection	Output	Response Time	Models
Normal Speed:500 mm High Speed:250 mm	140 kHz	4-pin Euro QD	—	—	M25UEQ8 Emitter
Normal Speed:500 mm High Speed:250 mm	140 kHz	5-pin Euro QD	Bipolar NPN/PNP	Normal Speed: 4.0 ms High Speed: 3.0 ms	M25URBQ8 Receiver

 Connection options: A model with a QD requires a mating cordset

\* M25U receivers may be wired for either of two speed modes: Normal or High, depending on hookup. The Normal-Speed mode offers a sensing range of 500 mm. The Normal-Speed mode maximizes sensing energy, as is required in demanding environments. The High-Speed mode offers a sensing range of 250 mm. The High-Speed mode maximizes sensing response, as is needed in high-speed counting applications.



**Euro-Style with Shield**  
Straight connector models listed; for right-angle, add **RA** to the end of the model number (example, **MQDEC2-506RA**)

**5-Pin**  
**MQDEC2-506**  
2 m (6.5')  
**MQDEC2-515**  
5 m (15')  
**MQDEC2-530**  
9 m (30')



Washdown **Euro-Style**  
Straight connector models listed

**5-Pin**  
**MQDCWD-506**  
2 m (6.5')  
**MQDCWD-530**  
9 m (30')

Additional cordset information is available  
See page 758



SMBM25A



SMBM25B

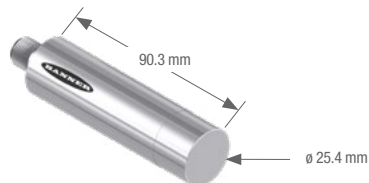

Additional bracket information is available  
See page 725

### M25U Specifications

<b>Sensing Range</b>	<b>Normal Speed:</b> 500 mm <b>High Speed:</b> 250 mm 140KHz
<b>Supply Voltage and Current</b>	<b>Emitter:</b> 10 to 30 V dc (10% max. ripple) at less than 85 mA <b>Receiver:</b> 10 to 30 V dc (10% max. ripple) at less than 38 mA (exclusive of load)
<b>Supply Protection Circuitry</b>	Protected against reverse polarity and transient voltages
<b>Receiver Output Configuration</b>	Bipolar (1 NPN & 1 PNP) solid-state output; Normally Open (output is activated when an object blocks the sensing beam)
<b>Output Rating</b>	100 mA (each output) with short circuit protection; see Note 1 <b>OFF-state leakage current:</b> NPN: < 200 µA sinking <b>ON-state saturation voltage:</b> NPN: < 1.6 V @ 100 mA PNP: < 10 µA sourcing PNP: < 3.0 V @ 100 mA
<b>Output Protection Circuitry</b>	Protected against short circuit conditions
<b>Output Response Time</b>	<b>Normal Speed:</b> 4.0 milliseconds <b>High Speed:</b> 3.0 milliseconds
<b>Repeatability</b>	1 millisecond
<b>Delay at Power-up</b>	< 250 milliseconds
<b>Delay for Switching Between Normal and High Speed</b>	20 milliseconds
<b>Indicators</b>	<b>Green Power LED:</b> indicates Power ON <b>Amber Output LED:</b> indicates output activated
<b>Construction</b>	<b>Housing:</b> 316 Stainless Steel <b>LED window:</b> Polysulfone
<b>Environmental Rating</b>	Leakproof design, rated IEC IP67 (NEMA 6), IP69K
<b>Operating Conditions</b>	<b>Temperature:</b> -20 to +70 °C <b>Max. Relative Humidity:</b> 95% at 50 °C non-condensing
<b>Vibration and Mechanical Shock</b>	All models meet Mil. Std. 202F requirements method 201A (vibration: 10 to 60 Hz max. amplitude 0.06", max. acceleration 10G). Also meets IEC 947-5-2; 30G 11 ms duration.
<b>Certifications</b>	<b>CE</b>

**Notes**

1. NPN < 200 µA for load impedance > 3 KΩ; for load current of 100 mA, leakage < 1% of load current
2. When mounting the M25U, care should be taken to acoustically isolate the emitter and receiver to eliminate sound energy coupling between the sensor pair. This is best accomplished with elastomeric materials between the sensor and rigid mounting brackets.

## SM30

High-Power, Long-Range, Opposed-Mode  
Barrel Sensors

- The SM30 is a powerful sensor with a long range for different frequencies and the stainless steel model can be used in abusive environments
- Available with ac or dc supply voltages
- Ideal in equipment washdown environments

SM30 Emitters, 10-30 V DC or 12-240 V AC, Frequency A<sup>†</sup>

Infrared LED

Sensing Mode	Housing	Range	Connection	Output Type	Models
 OPPOSED	Plastic	150 m	2 m 3-Pin Mini QD	N/A	SMA30PEL SMA30PELQD
	Stainless Steel	150 m	2 m 3-Pin Mini QD	N/A	SMA30SEL SMA30SELQD

SM30 Receivers, 10-30 V DC Frequency A<sup>†</sup>

Infrared LED

Sensing Mode	Housing	Range	Connection	Output Type	Models
 OPPOSED	Plastic	150 m	2 m 4-Pin Mini QD	Bi-Modal™ NPN or PNP	SM30PRL SM30PRLQD
	Stainless Steel	150 m	2 m 4-Pin Mini QD	Bi-Modal™ NPN or PNP	SM30SRL SM30SRLQD

SM30 Receivers, 24-240 V AC, Frequency A<sup>†</sup>

Infrared LED

Sensing Mode	Housing	Range	Connection	Output Type	Models
 OPPOSED	Plastic	150 m	2 m 3-Pin Mini QD	LO	SM2A30PRL SM2A30PRLQD
	Stainless Steel	150 m	2 m 3-Pin Mini QD	LO	SM2A30SRL SM2A30SRLQD
	Plastic	150 m	2 m 3-Pin Mini QD	DO	SM2A30PRLNC SM2A30PRLNCQD
	Stainless Steel	150 m	2 m 3-Pin Mini QD	DO	SM2A30SRLNC SM2A30SRLNCQD

Connection options: A model with a QD requires a mating cordset.

For 9 m cable, add suffix W/30 to the 2 m model number (example, SM30PR W/30).

<sup>†</sup> Modulation frequency "A" is standard; frequencies "B" and "C" are also available to minimize optical crosstalk potential between adjacent pairs and are specified by adding "B" or "C" at the end of the standard model number (example, SM30PRLB or SM30PRLC).

Mini QD  
Straight connector  
models listed



	3-Pin	4-Pin
	SM30CC-306	MBCC-406
	2 m (6.5')	2 m (6.5')
	SM30CC-312	MBCC-412
	3 m (12')	3 m (12')

Additional cordset information is available  
See page 758



SMB30A



SMB30FA..

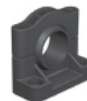

SMB30SC



SMBAMS30P

Additional bracket information is available  
See page 724

Apertures



Additional information is available  
See page 816



Opposed Models—All Frequencies  
Suffix E and R

SM30 Specifications

Supply Voltage and Current	<p><b>Emitters:</b> 12 to 240 V ac (50/60 Hz) or 10 to 30 V dc (10% max. ripple) at 20 mA</p> <p><b>DC Receivers:</b> 10 to 30 V dc (10% max. ripple) at 10 mA max, exclusive of load</p> <p><b>AC Receivers:</b> 24 to 240 V ac (50/60 Hz)</p>
Supply Protection Circuitry	Protected against reverse polarity and transient voltages
Output Configuration	<p><b>DC Receivers:</b> Bi-Modal™ output (PNP sourcing or NPN sinking). Selection of sourcing or sinking configuration depends upon receiver's power supply hookup polarity. Once wired, the unit performs as a solid-state switch.</p> <p><b>AC Receivers:</b> Solid-state switch offer Light Operate (LO) or Dark Operate (DO) by model</p>
Output Rating	<p><b>DC Receivers:</b> 250 mA continuous</p> <p><b>Output saturation voltage:</b> (PNP &amp; NPN configuration) less than 1 volt at 10 mA; less than 2 volts at 250 mA</p> <p><b>OFF-state leakage current:</b> less than 10 µA</p> <p><b>AC Receivers:</b> Max. steady-state load capability is 500 mA</p> <p><b>Inrush capability:</b> 10 amps for 1 second (non-repeating)</p> <p><b>OFF-state leakage:</b> current less than 1.7 mA rms</p> <p><b>ON-state voltage drop:</b> less than 3.5 volts rms across a 500 mA load; less than 5 volts rms across a 15 mA load</p>
Output Protection Circuitry	Outputs of dc receivers are short circuit protected
Output Response Time	10 milliseconds ON/OFF
Repeatability	<p>"A" frequency units: 1 millisecond</p> <p>"B" frequency units: 1.5 milliseconds</p> <p>"C" frequency units: 2.3 milliseconds</p>
Indicators	<p>Internal Red LED, visible through the lens or from side of the sensor.</p> <p><b>Emitters:</b> Red "Power ON" indicator LED</p> <p><b>DC Receivers:</b> Lights whenever receiver sees its modulated light source</p> <p><b>AC Receivers:</b> Lights whenever receiver's output is conducting</p>
Construction	Fully epoxy-encapsulated tubular threaded housing, positive sealed at both ends, quad-ring sealed acrylic lens 30 mm diameter 303 stainless steel housing and jam nuts
Environmental Rating	Exceeds NEMA 6P; IEC IP67 standards
Operating Conditions	<b>Temperature:</b> -40 to +70 °C <b>Relative humidity:</b> 90% at 50 °C (non-condensing)

Certifications



# VSM Series

## Self-Contained Metal Sensors



- Heavy-duty, compact, metal sensors that are ideal for use in confined areas.
- Sapphire lens
- Tough 300 series stainless steel body withstands a wide variety of chemicals and cutting fluids
- Smooth barrel models are ideal for hygienic applications that require frequent cleaning
- Advanced optical design provides high performance with repeatable sensing

### VSMQ (Flat-Pack, Side-Looker)

Infrared LED

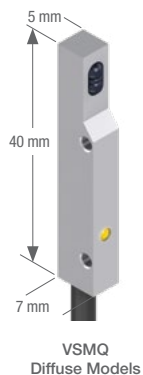

Sensing Mode	Range	Connection	Output Type	Models NPN	Models PNP
DIFFUSE	20-50 mm	2 m	LO	VSMQAN6CV20	VSMQAP6CV20
DIFFUSE	50-140 mm	2 m	LO	VSMQAN6CV50	VSMQAP6CV50
DIFFUSE	90-200 mm	2 m	LO	VSMQAN6CV90	VSMQAP6CV90

### VSM4 (4 mm Smooth Barrel)

Infrared LED

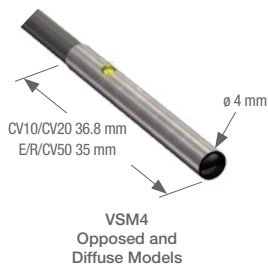

Sensing Mode	Range	Connection	Output Type	Models NPN	Models PNP
OPPOSED	250 mm	2 m	—	VSM46E Emitter	
	250 mm	3-Pin Pico QD	—	VSM46EQ7 Emitter	
OPPOSED	250 mm	2 m	DO	VSM4RN6R	VSM4RP6R
	250 mm	3-Pin Pico QD		VSM4RN6RQ7	VSM4RP6RQ7
DIFFUSE	10-30 mm	2 m	LO	VSM4AN6CV10	VSM4AP6CV10
	10-30 mm	3-Pin Pico QD		VSM4AN6CV10Q7	VSM4AP6CV10Q7
DIFFUSE	20-50 mm	2 m	LO	VSM4AN6CV20	VSM4AP6CV20
		3-Pin Pico QD		VSM4AN6CV20Q7	VSM4AP6CV20Q7
DIFFUSE	50-140 mm	2 m	LO	VSM4AN6CV50	VSM4AP6CV50
		3-Pin Pico QD		VSM4AN6CV50Q7	VSM4AP6CV50Q7

Connection options: A model with a QD requires a mating cordset.

VSM5 (5 mm Threaded Barrel)

 Infrared LED

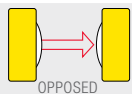
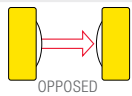
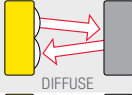
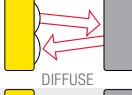
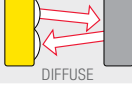
Sensing Mode	Range	Connection	Output Type	Models NPN	Models PNP
 OPPOSED	250 mm	2 m 3-Pin Pico QD	—	VSM56E Emitter VSM56EQ7 Emitter	
 OPPOSED	250 mm	2 m 3-Pin Pico QD	DO	VSM5RN6R VSM5RN6RQ7	VSM5RP6R VSM5RP6RQ7
 DIFFUSE	10-30 mm	2 m 3-Pin Pico QD	LO	VSM5AN6CV10 VSM5AN6CV10Q7	VSM5AP6CV10 VSM5AP6CV10Q7
 DIFFUSE	20-50 mm	2 m 3-Pin Pico QD	LO	VSM5AN6CV20 VSM5AN6CV20Q7	VSM5AP6CV20 VSM5AP6CV20Q7
 DIFFUSE	50-140 mm	2 m 3-Pin Pico QD	LO	VSM5AN6CV50 VSM5AN6CV50Q7	VSM5AP6CV50 VSM5AP6CV50Q7



 Connection options: A model with a QD requires a mating cordset.

**Pico QD (for Q models)**  
Straight connector models listed; for right-angle, **W** replaces **G** in the model number. (example, **PKW3M-2**)



**3-Pin**  
**PKG3M-2**  
2 m (6')  
**PKG3M-5**  
5 m (15')  
**PKG3M-9**  
9 m (30')



SMBVSM4

Additional cordset information is available  
See page 758

VSM Specifications

Supply Voltage and Current	10 to 30 V dc (10% max. ripple)
Supply Protection Circuitry	Protected against reverse polarity and transient voltages
Output Configuration	<b>Single-output:</b> 1 NPN or 1 PNP, Light Operate (LO) or Dark Operate (DO), depending on model
Output Rating	100 mA max. <b>OFF-state leakage current:</b> less than 1 µA <b>ON-state saturation voltage:</b> less than 2 V @ 100 mA
Output Protection Circuitry	Protected against false pulse on power-up and continuous overload or short circuit of outputs Overload trip point ≥ 100 mA
Response Time	2.5 milliseconds
Delay at Power-up	20 milliseconds
Repeatability	1 millisecond
Indicators	<b>Yellow LED:</b> light sensed
Construction	300 series stainless steel with PVC cable <b>CV10 &amp; CV20:</b> sapphire lens <b>CV50 &amp; Opposed:</b> Glass lens
Environmental Rating	IP67
Connections	2 m PVC-jacketed cable or 3-pin Pico-style integral QD (Q7), depending on model. QD cordsets ordered separately.
Operating Conditions	<b>Operating temperature:</b> 0° to +55 °C

Certification



## M18-4

## Heavy-Duty 18 mm Metal Barrel-Mount



- Chemically robust stainless steel sensors for washdown applications
- Robust housing is sealed against fluid ingress and exposure to harsh chemicals
- Powerful and bright visible red emitter beam for easy alignment and setup
- Highly visible output and dual-function power and stability indicators
- Advanced ASIC technology is resistant to fluorescent light and offers exceptional cross talk immunity
- Robust 250° adjustment potentiometer on select models
- Available in Emitter/Receiver, Polarized Retroreflective, Retroreflective, Diffuse, and Fixed Field models

## M18-4

Example Model Number M18-4VPFF50-Q8

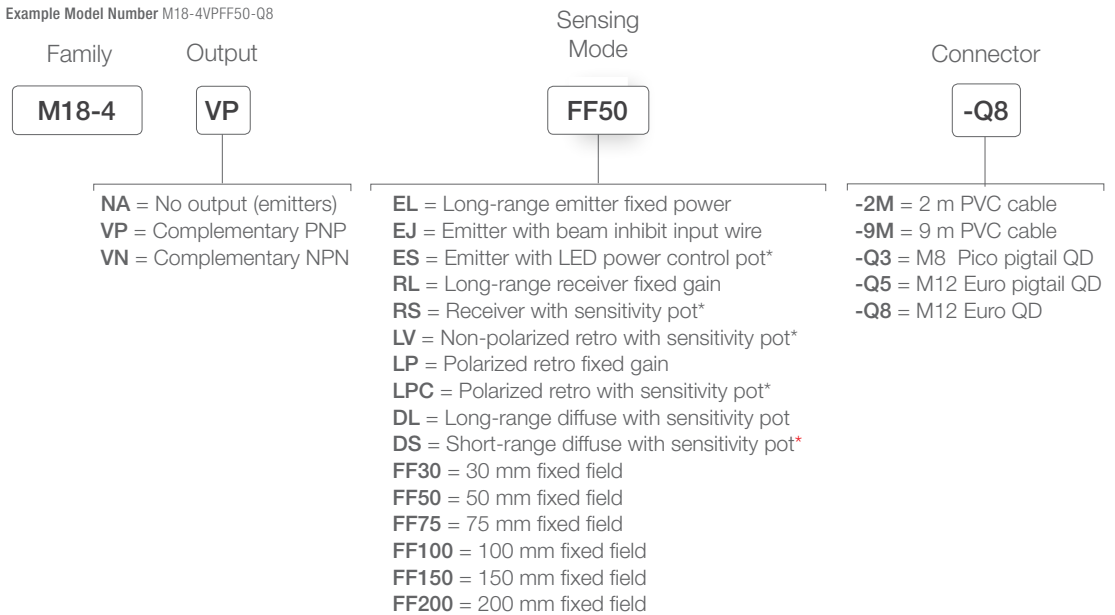

\* Sensitivity adjustment

 Connection options: A model with a QD requires a mating cordset.

† Retroreflective range is specified using one model BRT-3 retroreflector, unless otherwise noted.

Actual sensing range may differ, depending on the efficiency and reflective area of the retroreflector used. See Accessories section for more information.





**Euro-Style Cordsets**  
Straight connector models listed; for right-angle, add **RA** to the end of the model number (example, **MQDC-406RA**)

**4-Pin**  
**MQDC-406**  
2 m (6.5')  
**MQDC-415**  
5 m (15')  
**MQDC-430**  
9 m (30')



**M12/Euro-Style Washdown (IP69K)**  
Straight connector models only

**4-Pin**  
**MQDC-WDSS-0406**  
2 m (6.5')  
**MQDC-WDSS-0415**  
5 m (15')  
**MQDC-WDSS-0430**  
9 m (30')

Additional cordset information is available  
See page 758



SMB18FA..



SMB18A



SMB18SF

Additional bracket information is available  
See page 725

**Reflectors**



**Apertures**





Additional information is available  
See page 790

Additional information is available  
See page 816



M18-4

**M18-4 Specifications**

<b>Supply Voltage and Current</b>	10 V to 30 V dc for ambient temperature $\leq 55^\circ\text{C}$	10 V to 24 V dc for ambient temperature $> 55^\circ\text{C}$
<b>Supply Protection Circuitry</b>	Protected against reverse polarity and transient voltages	
<b>Output Configuration</b>	Solid-state complementary dc switch; NPN (current sinking) or PNP (current sourcing), depending on model The Dark Operate (DO) output may be wired as a normally open marginal signal alarm output, depending upon hookup to the power supply	
<b>Output Rating</b>	$\leq 50$ mA total current for ambient temperatures $> 55^\circ\text{C}$ <b>OFF-State Leakage Current:</b> $< 50$ $\mu\text{A}$ at 30 V dc	$\leq 100$ mA total current through both outputs $\leq 55^\circ\text{C}$ <b>ON-State Saturation Voltage:</b> $< 1.5$ V at 10 mA; $< 3.0$ V at 100 mA
<b>Output Protection Circuitry</b>	Protected against false pulse on power-up and continuous short circuit of outputs. Short circuit protection at elevated temperature may require a power cycle to reset.	
<b>Output Response Time</b>	<b>Opposed, Fixed Field:</b> 1.5 milliseconds ON, 1.5 milliseconds OFF <b>Polarized Retroreflective, Retroreflective, Fixed-field and Diffuse:</b> 1.5 milliseconds ON, 0.75 milliseconds OFF <b>Delay on Power-up:</b> 100 milliseconds; outputs do not conduct during this time	
<b>Delay at Power-up</b>	100 milliseconds; outputs are non-conducting during this time	
<b>Repeatability</b>	<b>Opposed:</b> 170 microseconds <b>Polarized Retroreflective, Retroreflective, Diffuse, Fixed Field:</b> 100 microseconds Repeatability and response are independent of signal strength	
<b>Indicators</b>	Three LEDs (1 green, 2 amber) <b>Green solid:</b> indicates power applied and sensor ready <b>Green flashing:</b> indicates marginal sensing signal <b>Amber solid:</b> indicates Pin 4 (black wire) output conducting	
<b>Emitter LED</b>	Visible red	
<b>Construction</b>	<b>Housing:</b> 316L stainless steel <b>Front window:</b> PMMA	<b>Indicator windows:</b> Clear polysulfone (PSU) <b>Indicator cover and gain pot driver:</b> Black PSU
<b>Environmental Rating</b>	IEC 60529 IP67, IP68, and IP69K	
<b>Operating Conditions</b>	<b>Temperature:</b> $-40^\circ$ to $+70^\circ\text{C}$	<b>Relative humidity:</b> 95% at $50^\circ\text{C}$ (non-condensing)
<b>Vibration and Mechanical Shock</b>	All models meet Mil. Std. 202F requirements. Method 201A (Vibration; frequency 10 to 60 Hz, max., double amplitude 0.06 in acceleration 10G). Method 213B conditions H&I (Shock: 75G with unit operating; 100G for non-operation)	
<b>Certifications</b>	 	



---

## Clear Object

Clear object detection sensors reliably and quickly detect clear, transparent and mirror-like surfaces with various visible red laser or ultrasonic sensor models for high precision detection.

Series	Description	Max Sensing Range	Dimensions H x W x D	Protection Rating	Housing Material	Power Supply
	<b>QS18</b> The QS18E features a polarized coaxial optical design to ensure reliable detection of clear targets and has a fast 400 microsecond response time. page 312	3 m	34.5 x 15 x 31 mm	IP67	ABS	10 to 30 V dc
	<b>Q4X COD</b> The Q4X sensor solves many challenging applications and comes in a rugged IP69K rating with FDA food grade stainless steel casing. page 314	300 mm	44 x 22 x 33 mm	IP67 IP68 IP69K	Stainless Steel	12 to 30 V dc
	<b>QS30</b> The QS30 reliably detects clear, translucent and opaque objects faster than other clear object detection sensor options. page 316	<b>Retro:</b> 2 m	44 x 22 x 33 mm	IP67	ABS	10 to 30 V dc
	<b>Q26</b> Coaxial optics enable reliable detection of clear, translucent or opaque objects including mirror-like surfaces. page 318	<b>Coaxial Polar Retro:</b> 800 mm	52.3 x 45 x 25 mm	IP67	ABS	12 to 30 V dc
	<b>OMNI-BEAM</b> Modular self-contained photoelectric sensors can be customized for specific applications and offer reliable clear object detection. page 320	<b>Polar Retro:</b> 4 m	H (varies by model) 44.5 x 54.6 mm	IP66	Thermoplastic polyester	10 to 30 V dc
	<b>MINI-BEAM</b> Universal housing design with 18 mm threaded lens; an ideal replacement for other sensor styles. page 322	<b>Polar Retro:</b> 1 m	33.3 x 12.53.1 mm	IP67	Thermoplastic polyester	10 to 30 V dc

OTHER AVAILABLE MODELS



QS18U page 236



Q4X page 34



T18U page 226



T30UX page 224



QM26 page 298



QMH26 page 300

# QS18

## Clear Object Detection Sensor



- Polarized coaxial optical design ensures reliable detection of transparent, translucent, and opaque targets at any distance between sensor and reflector
- Suitable for low contrast sensing application: PET bottles, glass containers, shrink wrap
- Detect surfaces such as: LCD panels with built in polarizing films, solar panels, and semiconductor wafers
- IO-Link option available

### QS18 COD *Expert*

Example Model Number: QS18EN6XLPCQ8

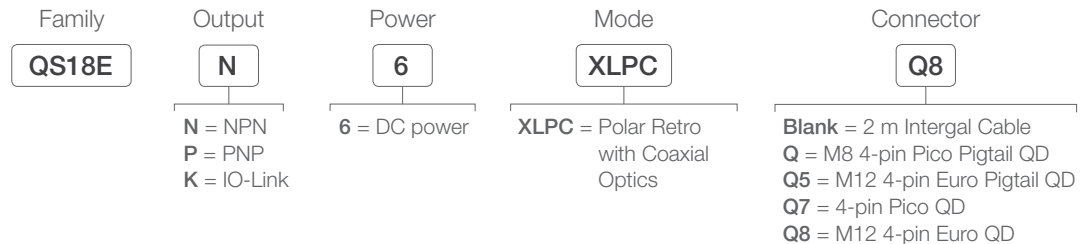

### QS18 COD with Potentiometer

Example Model Number: QS18VN6XLPCQ8

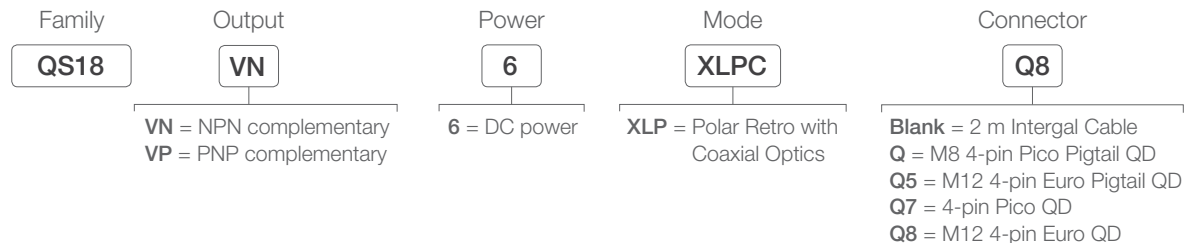

Connection options: A model with a QD requires a mating cordset.

**Euro QD**  
(for ..Q8 or ..Q5 models)  
Straight connector models listed; for right-angle, add **RA** to the end of the model number (example, **MQDC-406RA**)

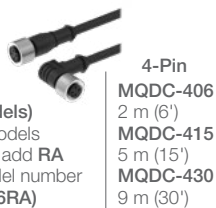

**Pico QD**  
Straight connector models listed; for right-angle, change **G** to **W** (example, **PKW4M-2**)

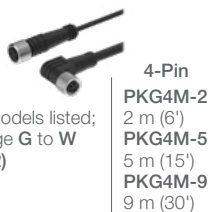

Additional cordset information is available  
See page 758



SMB18A



**SMBQ4XFA**  
Includes 3/8" bolt for mounting

**SMBQ4XFAM10**  
Includes 10 mm bolt for mounting

**SMBQ4XFAM12**  
Clamps directly onto industry standard bracket systems of 1/2" or 12 mm rods

**Reflectors**



Additional information is available  
See page 790

Additional bracket information is available  
See page 722

**QS18 Clear Object Specifications**

<b>Supply Voltage</b>	10 to 30 V dc (10% max. ripple) at less than 35 mA, exclusive of load; 10 to 24 V dc @ greater than 55° C
<b>Supply Protection Circuitry</b>	Protected against reverse polarity and transient voltages
<b>Output Configuration</b>	Solid-state NPN (current sinking) or PNP (current sourcing), depending on model Light (LO) or Dark Operate (DO) selectable Selectable 30 millisecond output OFF-delay <b>Rating:</b> 100 mA max. <b>OFF-state leakage current:</b> less than 50 µA @ 30 V dc <b>ON-state saturation voltage:</b> less than 1.5 V (2 m cable); 1.7 V (9 m cable) Protected against false pulse on power-up and continuous overload or short circuit of output
<b>Output Response Time</b>	400 microseconds ON/OFF
<b>Delay at Power-up</b>	Momentary delay on power-up; outputs do not conduct during this time
<b>Repeatability</b>	100 microseconds
<b>Adjustments</b>	<b>Thresholds:</b> Push-button/remote-wire configurable <b>Expert™-style TEACH and SET options:</b> <b>Light/Dark Operate:</b> selectable by programming order (load output follows the first taught target condition) <b>Push-button enable/disable:</b> remote wire only See datasheet for detailed information
<b>Indicators</b>	<b>2 LED indicators:</b> <b>Green:</b> RUN mode, output short-circuit <b>Yellow:</b> Output ON/marginal, TEACH mode
<b>Construction</b>	ABS housing
<b>Environmental Rating</b>	Meets NEMA 6; IEC IP67; UL Type 1
<b>Operating Conditions</b>	<b>Temperature:</b> -20 to +70 °C <b>Relative humidity:</b> 90% @ 50 °C (non-condensing)

Certifications



# Q4X Series

## Clear Object Detection Sensor



- A simple user experience from installation to setup
  - Bright spot alignment
  - Three push buttons simplify setup
  - Intuitive menus
- Four-digit display shows percent match
- FDA-grade stainless steel is suitable for IP69K washdown environments

### Q4X COD Threaded Barrel

Example Model Number: Q4XTBCOD300-Q8

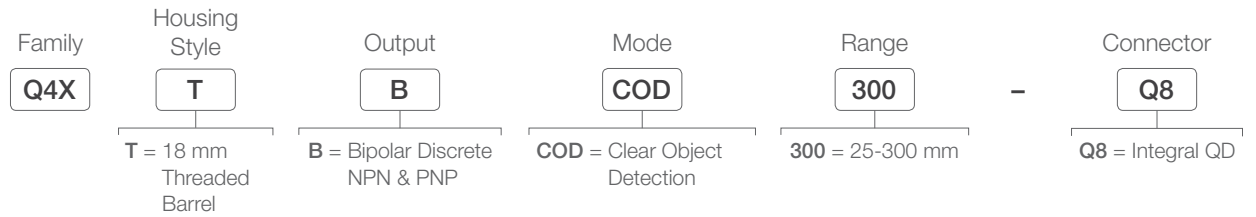

### Q4X COD Flush Mount

Example Model Number: Q4XFNCOD310-Q8

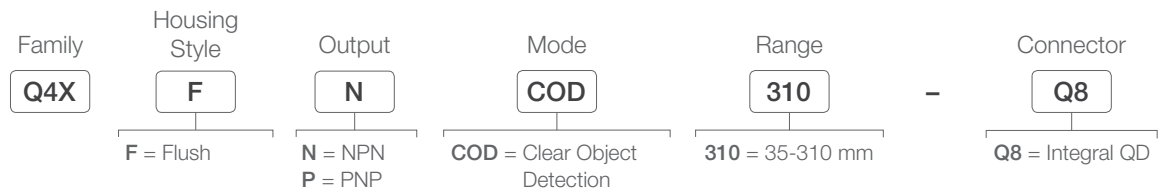

Q4XT.. models



Q4XF.. models

Connection options: A model with a QD requires a mating cordset.



**M12/Euro-Style**  
Straight connector models listed; for right-angle, add RA to the end of the model number (example, MQDC1-506RA)

**5-Pin**  
MQDC1-506  
2 m (6.5')  
MQDC1-515  
5 m (15')  
MQDC1-530  
9 m (30')



**M12/Euro-Style Washdown (IP69K)**  
Straight connector models only

**5-Pin**  
MQDC-WDSS-0506  
2 m (6.5')  
MQDC-WDSS-0515  
5 m (15')  
MQDC-WDSS-0530  
9 m (30')

Additional cordset information is available  
See page 758



SMB18A



SMBAMS18P



SMBAMS18RA



SMB46L2



**SMBQ4XFA**  
includes 3/8" bolt for mounting

**SMBQ4XFAM10**  
includes 10 mm bolt for mounting

**SMBQ4XFAM12**  
clamps directly onto industry standard bracket systems of 1/2" or 12 mm rods

Additional bracket information is available  
See page 722

### Q4X Specifications

Supply Voltage and Current	10 to 30 V dc		
Laser Characteristics	Wavelength: Class 1 Laser: 655 nm visible red		
Beam Spot Size	Distance (mm)	Size (Horizontal x Vertical)	
	25/35	2.4 mm x 1.0 mm	
	50/60	2.32mm x 0.9 mm	
	100/110	1.8 mm x 0.7 mm	
Output Response Time	User selectable: 50 ms, 25 ms, 10 ms, 3 ms and 1.5 msw		
Excess Gain	HIGH Excess Gain (STANDARD Excess Gain)		
	Response Speed (ms)	Excess Gain (90% white card)	
		25/35 mm	300/310 mm
		1.5	200
3		200	20
10	1000 (500)	100 (50*)	
25	2500 (1000)	250 (100*)	
50	5000 (2500)	500 (250*)	
Construction	Housing 316 L stainless steel; PMMA acrylic lens cover, Polysulfone lightpipe and display window		
Ambient Light Immunity	Greater than 5000 lux		
Environmental Rating	IP67 per IEC60529; IP68 per IEC60529; IP69K per DIN40050-9		
Operating Conditions	Temperature: -10 to +55 °C      Humidity: 35% to 95% relative humidity		

Certifications





# QS30

## Right-Angle Clear Object Detection Sensors



- The QS30 reliably detects clear, translucent and opaque objects faster than other clear object detection sensor options
- Three selectable thresholds based on type of target being detected
- Easy configuration of sensor via push buttons or remote wire
- Rugged housing rated to IP67 NEMA 6

### QS30 Expert™, 10-30 V DC

Visible Red LED

Sensing Mode	Laser Class	Range	Connection	Model Bipolar NPN/PNP
	—	100 mm to 2 m†	2 m	QS30ELVC
			5-pin Euro QD	QS30ELVCQ

Connection options: A model with a QD requires a mating cordset.

For 9 m cable, add suffix W/30 to the 2 m model number (example, QS30ELVC W/30).

† BRT-2X2LVC and BRT40X19A retroreflectors are included with sensor.



**Euro-Style Cordsets**  
Straight connector models listed; for right-angle, add **RA** to the end of the model number (example, **MQDC1-506RA**)

**5-Pin**  
**MQDC1-506**  
2 m (6.5')  
**MQDC1-515**  
5 m (15')  
**MQDC1-530**  
9 m (30')



SMB30A



SMBQS30L



SMBQS30YL



SMBQS30Y

Additional cordset information is available  
See page 758

Additional bracket information is available  
See page 722

**Reflectors**



Additional information is available  
See page 790

**Apertures**



Additional information is available  
See page 816



Retroreflective Expert Models  
Suffix ELVC

QS30 Expert™ Specifications

<b>Supply Voltage and Current</b>	10 to 30 V dc (10% max. ripple) at less than 25 mA, exclusive of load
<b>Output Protection Circuitry</b>	Protected against output short-circuit, continuous overload, transient over-voltages and false pulse on power-up
<b>Sensing Beam</b>	660 nm visible Red
<b>Supply Protection Circuitry</b>	Protected against reverse polarity; over voltage and transient voltages
<b>Output Configuration</b>	<b>Bipolar:</b> One NPN (current sinking) and one PNP (current sourcing); Light Operate (LO) or Dark Operate (DO) configurable
<b>Output Response Time</b>	500 microseconds
<b>Delay at Power-up</b>	250 milliseconds; outputs do not conduct during this time
<b>Repeatability</b>	150 microseconds
<b>Adjustments</b>	2 push buttons and remote wire for TEACH programming and configuration See data sheet for detailed information
<b>Indicators</b>	<b>2 LEDs: Green:</b> Power ON <b>Yellow:</b> Output conducting  See data sheet for more detailed information
<b>Construction</b>	PC/ABS housing with acrylic lens cover
<b>Environmental Rating</b>	IEC IP67 (NEMA 6); PW12 1200 PSI washdown
<b>Operating Conditions</b>	<b>Temperature:</b> -10 to +55 °C <b>Relative humidity:</b> 95% @ 55 °C (non-condensing)
<b>Vibration and Mechanical Shock</b>	All models meet Mil. Std. 202F requirements. Method 201A (Vibration; frequency 10 to 60 Hz max., double amplitude 0.06-inch acceleration 10G). Also meets IEC 947-5-2 requirements: 30G, 11 milliseconds duration, half-sine wave.
<b>Application Note</b>	If supply voltage is > 24 V dc, derate maximum output current 1 mA/°C above 25° C



## Q26

## Clear Object Sensors



- Coaxial optics enable reliable detection of clear, translucent or opaque objects including mirror-like surfaces
- Simple setup with a single turn sensitivity adjustment potentiometer
- Compact design ideal when space is limited
- Rugged ABS housing with glass window

## Q26

Sensing Mode	Range	Connection	Models NPN	Models PNP
	5-800 mm sensor to reflector distance with no detection	4-pin Pico QD	Q26NXLPQ7	Q26PXLQ7
		4-pin Euro Pigtail QD	Q26NXLPQ5	Q26PXLQ5

 Connection options: A model with a QD requires a mating cordset.

For a 9 m cable, add suffix W/30 to the 2 m model number (example, Q26NXLPQ7 W/30)



**Euro-Style Cordsets**  
Straight connector models listed; for right-angle, add **RA** to the end of the model number (example, **MQDC-406RA**)

**4-Pin**  
**MQDC-406**  
2 m (6.5')  
**MQDC-415**  
5 m (15')  
**MQDC-430**  
9 m (30')

Used with: Q models



**Pico-Style Cordsets**  
Straight connector models listed; for right-angle, replace the **G** with a **W** in the model number (example, **PKW4M-2**)

**4-Pin**  
**PKG4M-2**  
2 m (6.5')  
**PKG4M-5**  
5 m (15')  
**PKG4M-9**  
9 m (30')

Used with: Q7 models

Additional cordset information is available  
See page 758



SMBLSTDLQ26



SMBLSTQ26

Additional bracket information is available  
See page 725

**Reflectors**



Additional information is available  
See page 790

**Apertures**



Additional information is available  
See page 816



**Q26 Specifications**

<b>Supply Voltage and Current</b>	12 to 30 V dc (10% maximum ripple within specified limits); supply current (exclusive of load current): 15mA
<b>Supply Protection Circuitry</b>	Protected against reverse polarity and transient voltages
<b>Output Configuration</b>	Primary output (pin 2) NPN or PNP (current sinking or sourcing), depending on model; second output (pin 4) is a Health mode output
<b>Output Rating</b>	100 mA max <b>OFF-state leakage current:</b> less than 1 microamp @ 30 V dc <b>ON-state saturation voltage:</b> less than 1 V @ 10 mA dc; less than 1.5 V @ 150 mA dc
<b>Output Protection Circuitry</b>	Protected against false power-up and continuous overload or short circuit of outputs
<b>Output Response Time</b>	250 μS ON and OFF
<b>Repeatability</b>	50 microseconds
<b>Indicators</b>	<b>Green steady:</b> Power ON <b>Yellow steady:</b> Output conducting
<b>Construction</b>	ABS plastic housing; glass window
<b>Operating Conditions</b>	<b>Temperature:</b> -10 ° to +55 °C <b>Relative Humidity:</b> 90% at 50 °C; non-condensing
<b>Environmental Rating</b>	Leakproof design rated IP67
<b>Vibration and Shock</b>	EN60068-2-6 and EN60068-2-27

Certifications



## OMNI-BEAM™

## Rectangular Modular Sensors



- Modular self-contained photoelectric sensors can be customized for specific applications and offer reliable clear object detection
- Includes a sensor head and power block with optional timing logic module
- Offers interchangeable AC or DC power blocks
- Features exclusive multiple-LED system that display received signal strength, sensing contrast and seven different warnings

## OMNI-BEAM™ Sensor Heads

Visible Red LED

Sensing Mode	Range	Supply Voltage	Response & Repeatability	Models
	4 m†	Provided by Power Block	Response: 4 ms Repeatability: 0.2 ms	OSBLVAGC

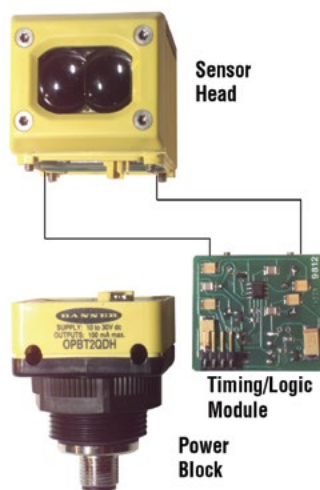

## OMNI-BEAM™ Power Blocks

Connection	Supply Voltage	Output Type	Models
2 m	10-30 V dc	Bi-Modal™ NPN or PNP <b>Two outputs:</b> Load and Alarm	OPBT2
4-Pin Mini QD			OPBT2QD
4-Pin Euro QD			OPBT2QDH
2 m	10-30 V dc	<b>No output:</b> for powering emitter-only sensor heads	OPBTE
4-Pin Mini QD			OPBTEQD
4-Pin Euro QD			OPBTEQDH
2 m	105-130 V ac	SPST solid-state ac relay <b>Two outputs:</b> Load and Alarm	OPBA2
5-Pin Mini QD			OPBA2QD
2 m	210-250 V ac		OPBB2
5-Pin Mini QD			OPBB2QD
2 m	105-130 V ac	<b>No output:</b> for powering emitter only sensor heads	OPBAE
5-Pin Mini QD			OPBAEQD
2 m	210-250 V ac		OPBBE
5-Pin Mini QD			OPBBEQD

**STEP 1:** Choose a power block for the required sensor power (ac or dc) and interface.

**STEP 2:** Choose a timing logic module (Optional)

**STEP 3:** Plug and bolt components together without interwiring.

OMNI-BEAM modular components are sold separately. The three modular components, and the lenses, can be replaced in the field.

† Retroreflective range is specified using one model BRT-3 retroreflector. Actual sensing range may differ, depending on efficiency and reflective area of the retroreflector in use. See Accessories for more information.  
NOTE: Sensor heads require a power block.

OMNI-BEAM™ Timing Logic Modules

Type	Logic Function	Timing Ranges	Models
Delay Timer Logic Module	ON-DELAY or OFF-DELAY or ON/OFF DELAY	<b>ON-Delay:</b> 0.01-1 sec., 0.15-15 sec., or none <b>OFF-Delay:</b> 0.01-1 sec., 0.15-15 sec., or none	OLM5
Pulse Timer Logic Module	ONE-SHOT pulse timer or DELAYED ONE-SHOT logic timer	<b>Delay:</b> 0.01-1 sec., 0.15-15 sec., or none <b>Pulse:</b> 0.01-1 sec., 0.15-15 sec.	OLM8



For information on Timing Diagrams, see data sheet

Connection options: A model with a QD requires a mating cordset.  
For 9 m cable, add suffix W/30 to the 2 m model number (example, OPBT2 W/30).

**Euro-Style Cordsets**  
Straight connector models listed; for right-angle, add **RA** to the end of the model number (example, **MQDC-406RA**)

4-Pin
<b>MQDC-406</b> 2 m (6.5')
<b>MQDC-415</b> 5 m (15')
<b>MQDC-430</b> 9 m (30')

**Mini-Style Cordsets**  
Straight connector models listed

4-Pin	5-Pin
<b>MBCC-406</b> 2 m (6.5')	<b>MBCC-506</b> 2 m (6.5')
<b>MBCC-415</b> 5 m (15')	<b>MBCC-515</b> 5 m (15')
<b>MBCC-430</b> 9 m (30')	<b>MBCC-530</b> 9 m (30')

Additional cordset information is available  
See page 758



SMB30A



SMB30FA..

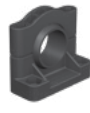

SMB30SC

Additional bracket information is available  
See page 737

Reflectors

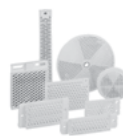

Additional information is available  
See page 790

OMNI-BEAM™ Specifications

See website for more details [www.bannerengineering.com](http://www.bannerengineering.com)

# MINI-BEAM®

## Clear Object Sensor with Mounting Versatility



- Universal housing design with 18 mm threaded lens; an ideal replacement for hundreds of other sensor styles. Available in eight modes with a compact housing for limited space setups
- Versatile sensor with several mounting options
- Meets IP67 and NEMA 6 standards for harsh environment
- Universal housing design

### MINI-BEAM® *Expert*, 10-30 V DC

➔ Visible Red LED

Sensing Mode	Range	Connection	Output	Models
	1 m	2 m	Bipolar NPN/PNP	SME312LPC*
		5-Pin Euro QD		SME312LPCQD*

➔ Connection options: A model with a QD requires a mating cordset.

For 9 m cable, add suffix W/30 to the 2 m model number (example, SME312D W/30).

\* NOTE: For clear object detection, sensing range varies, according to the efficiency and reflective area of the retroreflector(s) used.

For these low-contrast applications, the model BRT-2X2 reflector is recommended and is included with each SME312LPC(QD) sensor.

- For applications with high vibration, the model BRT-51X51BM, with its micro-prism geometry, is recommended.
- For long-range applications, the BRT-77X77C reflector provides a range up to 2 m.
- SME312LPC(QD) are for use with corner cube type reflectors only; reflective tape is not recommended.



**Euro-Style Cordsets**

Straight connector models listed; for right-angle, add **RA** to the end of the model number (example, MQDC-406RA)

**5-Pin****MQDC1-506**

2 m (6.5')

**MQDC1-515**

5 m (15')

**MQDC1-530**

9 m (30')

Additional cordset information is available  
See page 758

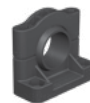
**SMB18A****SMB18FA..****SMB18SF****SMB312B****SMB3018SC**

Additional bracket information is available  
See page 722

**Reflectors**

Additional information is available  
See page 790

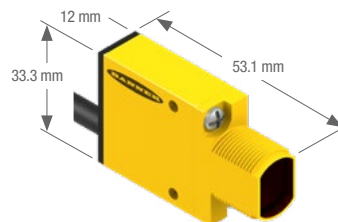
**MINI-BEAM dc**  
Suffix EPD and RPD**MINI-BEAM® Expert™ Specifications**

<b>Supply Voltage and Current</b>	10 to 30 V dc (10% max. ripple) at less than 45 mA, exclusive of load
<b>Supply Protection Circuitry</b>	Protected against reverse polarity and transient voltages
<b>Output Configuration</b>	<b>Bipolar:</b> One current sourcing (PNP) and one current sinking (NPN) open-collector transistor Configuration in TEACH sequence for Light Operate (LO) or Dark Operate (DO)
<b>Output Rating</b>	150 mA max. each output at 25 °C, derated to 100 mA at 70 °C (derate $\approx 1$ mA per °C) <b>OFF-state leakage current:</b> less than 5 $\mu$ A @ 30 V dc <b>Output saturation voltage (PNP output):</b> less than 1 V at 10 mA and less than 2 V at 150 mA <b>Output saturation voltage (NPN output):</b> less than 200 mV at 10 mA and less than 1 V at 150 mA
<b>Output Protection Circuitry</b>	Protected against false pulse on power-up and continuous overload or short-circuit of outputs
<b>Output Response Time</b>	Sensors will respond to either a "light" or a "dark" signal of 500 microseconds or longer duration, 1 kHz max.
<b>Delay at Power-up</b>	1 second; outputs do not conduct during this time
<b>Repeatability</b>	100 microseconds (all models)
<b>Adjustments</b>	Push-button TEACH mode sensitivity setting; remote TEACH mode input is provided (gray wire)
<b>Indicators</b>	<b>Two LEDs:</b> Yellow and Bicolor Green/Red <b>Green:</b> power ON <b>Red:</b> OFF when no signal is received <b>Yellow (TEACH Mode):</b> ON to indicate sensor is ready to learn output ON condition OFF to indicate sensor is ready to learn output OFF condition <b>Yellow (RUN Mode):</b> ON when outputs are conducting See data sheet for more detailed information
<b>Construction</b>	Reinforced thermoplastic polyester housing, totally encapsulated, o-ring seal, acrylic lenses, and stainless steel screws
<b>Environmental Rating</b>	Meets NEMA standards 1, 2, 3, 3S, 4, 4X, 6, 12, and 13; IEC IP67
<b>Operating Conditions</b>	<b>Temperature:</b> -20 to +70 °C <b>Relative humidity:</b> 90% at 50 °C (non-condensing)
<b>Application Notes</b>	The first condition presented during TEACH mode becomes the output ON condition

**Certifications**



---

## Temperature

Temperature sensors are passive, non-contact sensors that are able to detect a change as small as 3 °C.

Series	Description	Temperature Measurement Range	Dimensions H x W x D	Protection Rating	Housing Material	Power Supply
	<p><b>M18T</b> A small, self-contained design with easy to use TEACH mode programming. page 326</p>	<p>0 to 300 °C</p>	<p>H (varies by model) ø18 mm</p>	<p>IP67</p>	<p>304 Stainless Steel</p>	<p>10 to 30 V dc</p>

OTHER AVAILABLE MODELS



M12F page 264

## M18T

## Rugged Temperature Sensors



- The M18T has a small, self-contained design and has easy-to-use TEACH mode programming
- Rugged, encapsulated design for harsh environments
- Remote Teach available in both Static and Dynamic modes

## Discrete M18T, 10-30 V DC

Sensing Mode	D:S Ratio*	Sensing Face	Connection	Output	Models
	8:1	Integrated lens	2 m 5-Pin Euro QD	Bipolar (NPN and PNP)	<b>M18TB8</b> <b>M18TB8Q</b>
	6:1	Enclosed plastic face (for food industry use)	2 m 5-Pin Euro QD	Bipolar (NPN and PNP)	<b>M18TB6E</b> <b>M18TB6EQ</b>
	14:1	Germanium lens	2 m 5-Pin Euro QD	Bipolar (NPN and PNP)	<b>M18TB14</b> <b>M18TB14Q</b>

## Analog M18T, 12-30 V DC

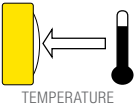
Sensing Mode	D:S Ratio*	Sensing Face	Connection	Output	Models
	8:1	Integrated lens	2 m 5-Pin Euro QD	0 to 10 V dc analog, plus PNP Alarm	<b>M18TUP8</b> <b>M18TUP8Q</b>
	6:1	Enclosed plastic face (for food industry use)	2 m 5-Pin Euro QD	0 to 10 V dc analog, plus PNP Alarm	<b>M18TUP6E</b> <b>M18TUP6EQ</b>
	14:1	Germanium lens	2 m 5-Pin Euro QD	0 to 10 V dc analog, plus PNP Alarm	<b>M18TUP14</b> <b>M18TUP14Q</b>
	8:1	Integrated lens	2 m 5-Pin Euro QD	4 to 20 mA analog, plus PNP Alarm	<b>M18TIP8</b> <b>M18TIP8Q</b>
	6:1	Enclosed plastic face (for food industry use)	2 m 5-Pin Euro QD	4 to 20 mA analog, plus PNP Alarm	<b>M18TIP6E</b> <b>M18TIP6EQ</b>
	14:1	Germanium lens	2 m 5-Pin Euro QD	4 to 20 mA analog, plus PNP Alarm	<b>M18TIP14</b> <b>M18TIP14Q</b>

 Connection options: A model with a QD requires a mating cordset.

For 9 m cable, add suffix W/30 to the 2 m model number (example, M18TB8 W/30).

\* For D:S ratio information see page 327



**Euro-Style with Shield**  
Straight connector models listed; for right-angle, add **RA** to the end of the model number (example, **MQDEC2-506RA**)

**5-Pin**  
**MQDEC2-506**  
2 m (6.5')  
**MQDEC2-515**  
5 m (15')  
**MQDEC2-530**  
9 m (30')

Additional cordset information is available  
See page 758



**SMB18A**



**SMB18SF**

Additional bracket information is available  
See page 723

### M18T Specifications



<b>Supply Voltage and Current</b>	<b>Discrete models:</b> 10 to 30 V dc (10% max. ripple) <b>Analog models:</b> 12 to 30 V dc (10% max. ripple)																																														
<b>Supply Protection Circuitry</b>	Protected against short circuit conditions																																														
<b>Output Rating</b>	<b>Analog Voltage:</b> 2.5 kΩ minimum load resistance <b>Analog Current:</b> 1 kΩ max. @ 24 V input; max. load resistance = $[(V_{cc} - 4)/0.02]\Omega$  For current output (4-20mA models): Ideal results are achieved when the total load resistance $R = [(V_{in} - 4)/0.02] \Omega$ Example, at $V_{in} = 24 \text{ V dc}$ , $R \approx 1\text{k}\Omega$ (1 watt) <b>Alarm: Off-state leakage:</b> < 10 microamps; <b>Saturation:</b> < 1.2 V @ 10 mA and < 1.6 V @ 100 mA																																														
<b>Output Protection Circuitry</b>	Protected against false pulse on power-up and continuous overload or short-circuit of outputs																																														
<b>Sensing Field of View</b>	Distance from Sensor Face Versus Sport Size <table border="1"> <thead> <tr> <th>D:S ratio</th> <th>100</th> <th>200</th> <th>300</th> <th>400</th> <th>500</th> <th>600</th> <th>700</th> <th>800</th> <th>900</th> <th>1000</th> <th>Distance (mm)</th> </tr> </thead> <tbody> <tr> <td>6:1</td> <td>17</td> <td>33</td> <td>50</td> <td>67</td> <td>83</td> <td>100</td> <td>117</td> <td>133</td> <td>150</td> <td>167</td> <td rowspan="3">Spot size (mm)</td> </tr> <tr> <td>8:1</td> <td>13</td> <td>25</td> <td>38</td> <td>50</td> <td>63</td> <td>75</td> <td>88</td> <td>100</td> <td>113</td> <td>125</td> </tr> <tr> <td>14:1</td> <td>7</td> <td>14</td> <td>21</td> <td>39</td> <td>36</td> <td>43</td> <td>50</td> <td>57</td> <td>64</td> <td>71</td> </tr> </tbody> </table>	D:S ratio	100	200	300	400	500	600	700	800	900	1000	Distance (mm)	6:1	17	33	50	67	83	100	117	133	150	167	Spot size (mm)	8:1	13	25	38	50	63	75	88	100	113	125	14:1	7	14	21	39	36	43	50	57	64	71
D:S ratio	100	200	300	400	500	600	700	800	900	1000	Distance (mm)																																				
6:1	17	33	50	67	83	100	117	133	150	167	Spot size (mm)																																				
8:1	13	25	38	50	63	75	88	100	113	125																																					
14:1	7	14	21	39	36	43	50	57	64	71																																					
<b>Construction</b>	<b>Threaded Barrel:</b> 304 stainless steel <b>Push Button Housing:</b> ABS/PC <b>Push Button:</b> Santoprene																																														
<b>Environmental Rating</b>	IEC IP67; NEMA 6																																														
<b>Operating Conditions</b>	<b>Temperature:</b> -20 to +70 °C																																														
<b>Certification</b>	<b>CE</b> (some models pending. Contact factory for additional information)																																														



---

## Hazardous Area

Sensors for hazardous areas are ideal for environments or locations with possibility of fire or explosion. Extensive approvals ensure sensors are safe to use in classified areas or zones.

Series	Description	Max Sensing Range		Dimensions H x W x D	Protection Rating	Housing Material	Power Supply
	<p><b>MINI-BEAM® NAMUR</b> Ideal for hazardous environments with approved switching amplifiers that have intrinsically safe input circuits. page 330</p>	<p><b>Opposed:</b> 6 m <b>Retro:</b> 5 m <b>Retro Polarized:</b> 2 m <b>Convergent:</b> 43 mm <b>Diffuse:</b> 380 mm <b>Glass/Plastic Fiber:</b> Varies</p>		30.7 x 12.2 x 66 mm	IP67	Thermoplastic Polyester	5 to 15 V dc
	<p><b>Q45 NAMUR</b> A specialized sensor for explosive environments meeting intrinsically safe standards to ensure it is safe for use in hazardous areas. page 336</p>	<p><b>Opposed:</b> 6 m <b>Retro:</b> 9 m <b>Retro Polarized:</b> 6 m <b>Convergent:</b> 100 mm <b>Diffuse:</b> 1 m <b>Glass/Plastic Fiber:</b> Varies</p>		87.6 x 44.5 (D varies by model)	IP67	Thermoplastic Polyester	5 to 15 V dc
	<p><b>SMI30</b> An extremely rugged and powerful intrinsically safe barrel sensor designed for the most demanding hazardous area sensing applications. page 338</p>	<p><b>Opposed:</b> 140 m</p>		ø30 x 102 mm	IP67	Thermoplastic Polyester	10 to 30 V dc



# MINI-BEAM® NAMUR

## Compact Sensors for Hazardous Areas



- The MIAD9 series NAMUR models are ideal for hazardous environments with approved switching amplifiers that have intrinsically safe input circuits
- Available in opposed, retroreflective, convergent, diffuse and fiber optic modes
- Infrared or visible red sensing beam
- Industry standard mounting holes

### Opposed MINI-BEAM®

Infrared LED

Sensing Mode	Range	Connection	Output	Models
OPPOSED	6 m	2 m 4-Pin Euro QD	—	MI9E Emitter MI9EQ Emitter
OPPOSED	6 m	2 m 4-Pin Euro QD	Constant Current: ≤1.2 mA dark ≥2.1 mA light	MIAD9R MIAD9RQ

### Retro & Polar Retro MINI-BEAM®

Visible Red LED

Sensing Mode	Range	Connection	Output	Models
RETRO	5 m	2 m 4-Pin Euro QD	Constant Current: ≤1.2 mA dark ≥2.1 mA light	MIAD9LV MIAD9LVQ
POLAR RETRO	50 mm - 2 m	2 m 4-Pin Euro QD	Constant Current: ≤1.2 mA dark ≥2.1 mA light	MIAD9LVAG MIAD9LVAGQ

For more specifications see page 333.

Connection options: A model with a QD requires a mating cordset (see page 332).

For 9 m cable, add suffix W/30 to the 2 m model number (example, MIAD9LV W/30).

## Convergent MINI-BEAM®

 Visible Red LED

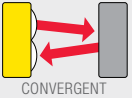
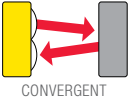
Sensing Mode	Range	Connection	Output	Models
 CONVERGENT	16 mm	2 m 4-Pin Euro QD	Constant Current: ≤1.2 mA dark ≥2.1 mA light	MIAD9CV MIAD9CVQ
 CONVERGENT	43 mm	2 m 4-Pin Euro QD	Constant Current: ≤1.2 mA dark ≥2.1 mA light	MIAD9CV2 MIAD9CV2Q

## Diffuse MINI-BEAM®

 Infrared LED

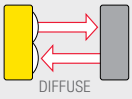
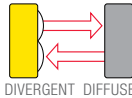
Sensing Mode	Range	Connection	Output	Models
 DIFFUSE	380 mm	2 m 4-Pin Euro QD	Constant Current: ≤1.2 mA dark ≥2.1 mA light	MIAD9D MIAD9DQ
 DIVERGENT DIFFUSE	75 mm	2 m 4-Pin Euro QD	Constant Current: ≤1.2 mA dark ≥2.1 mA light	MIAD9W MIAD9WQ

## MINI-BEAM® NAMUR

 Infrared LED

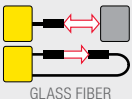
Sensing Mode	Range	Connection	Output	Models
 GLASS FIBER	Range varies by sensing mode and fiber optics used	2 m 4-Pin Euro QD	Constant Current: ≤1.2 mA dark ≥2.1 mA light	MIAD9F MIAD9FQ

For more specifications see page 333.

 Connection options: A model with a QD requires a mating cordset (see page 332).

For 9 m cable, add suffix W/30 to the 2 m model number (example, MIAD9LV W/30).

**NAMUR Euro-Style**  
Straight connector models listed;  
for right-angle, add **RA** to the end  
of the model number  
(example, **MQD9-406RA**)



**4-Pin**  
**MQD9-406**  
2 m (6.5')  
**MQD9-415**  
5 m (15')

*Additional cordset information is available  
See page 758*



**SMB312PD**



**SMB18FA**



**SMB312B**

*Additional bracket information is available  
See page 722*

**Reflectors**



*Additional information is available  
See page 821*

**Apertures**





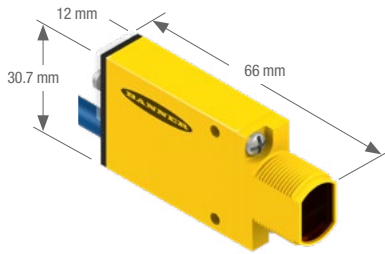

*Additional information is available  
See page 816*



**MINI-BEAM® NAMUR**  
Retroreflective, Diffuse and  
Convergent Models  
Suffix E, R, LV, D and CV

## MINI-BEAM® NAMUR Specifications

Supply Voltage	5 to 15 V dc (provided by the amplifier to which the sensor is connected)
Output	<b>Constant current output:</b> $\leq 1.2$ mA in the "dark" condition and $\geq 2.1$ mA in the "light" condition
Output Response Time	<b>Opposed receiver:</b> 2 milliseconds ON/400 microseconds OFF <b>All others:</b> 5 milliseconds ON/OFF (does not include amplifier response)
Adjustments	GAIN (sensitivity) adjustment potentiometer
Indicators	Red LED Alignment Indicator Device (AID) located on rear panel lights when the sensor sees a "light" condition; pulse rate is proportional to signal strength (the stronger the signal, the faster the pulse rate).
Construction	Reinforced thermoplastic polyester housing, totally encapsulated, o-ring sealing, acrylic lenses and stainless steel screws
Environmental Rating	Meets NEMA standards 1, 2, 3, 3S, 4, 4X, 6, 12 and 13; IEC IP67
Operating Conditions	<b>Temperature:</b> -40 to +70 °C <b>Relative humidity:</b> 90% at 50 °C (non-condensing)
Design Standards	<b>MIAD9 Series sensors comply with the following standards:</b> DIN 19 234, EN 50 014 Part 1. 1977, EN50 020 Part 7. 1977, Factory Mutual #3610 and 3611, CSA 22.2 #157-92 and 22.2 #213-M1987
Certifications	    

## APPROVALS

<b>CSA:</b> #LR 41887	<b>Intrinsically Safe, with Entity for:</b> Class I, Groups A-D Class I, Div. 2, Groups A-D	<b>FM:</b> #J.I. 5Y3A4.AX	<b>Intrinsically Safe, with Entity for:</b> Class I, II, III, Div. 1, Groups A-G Class I, II, III, Div. 2, Groups A-D and G
<b>KEMA:</b> #03ATEX1441X	II IG EEx ia IIC T6	<b>ETL:</b> #553868	

# Q45 NAMUR

## Rectangular Sensors for Hazardous Areas



- The Q45 NAMUR is a specialized sensor for explosive environments meeting intrinsically safe standards to ensure it is safe for use in hazardous areas
- Intrinsically safe dc models for potentially explosive environments
- For use with approved DIN 19 234 switching amplifiers

### Opposed Q45, 5-15 V DC

Infrared LED

Sensing Mode	Range	Connection	Output Type	Models
 OPPOSED	6 m	2 m	<b>Constant Current</b> $\leq 1.2$ mA dark $\geq 2.1$ mA light	Q459E Emitter
		4-Pin Euro QD		Q459EQ Emitter
		2 m		Q45AD9R
		4-Pin Euro QD		Q45AD9RQ

### Retro & Polar Retro Q45, 5-15 V DC

Visible Red LED

Sensing Mode	Range	Connection	Output Type	Models
 RETRO	9 m <sup>†</sup>	2 m	<b>Constant Current</b> $\leq 1.2$ mA dark $\geq 2.1$ mA light	Q45AD9LV
		4-Pin Euro QD		Q45AD9LVQ
 POLAR RETRO	6 m <sup>†</sup>	2 m	<b>Constant Current</b> $\leq 1.2$ mA dark $\geq 2.1$ mA light	Q45AD9LP
		4-Pin Euro QD		Q45AD9LPQ

For more specifications see page 337.

Connection options: A model with a QD requires a mating cordset (see page 336).

For 9 m cable, add suffix W/30 to the 2 m model number (example, Q459E W/30).

<sup>†</sup> Retroreflective range is specified using one model BRT-3 retroreflector.

Actual sensing range may differ, depending on efficiency and reflective area of the retroreflector in use. See Accessories for more information.

Diffuse Q45, 5-15 V DC

 Infrared LED

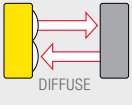
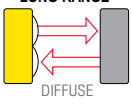
Sensing Mode	Range	Connection	Output Type	Models
 DIFFUSE	300 mm	2 m 4-Pin Euro QD	Constant Current ≤1.2 mA dark ≥2.1 mA light	Q45AD9D Q45AD9DQ
<b>LONG-RANGE</b>  DIFFUSE	1 m	2 m 4-Pin Euro QD	Constant Current ≤1.2 mA dark ≥2.1 mA light	Q45AD9DL Q45AD9DLQ

Convergent Q45, 5-15 V DC

 Visible Red LED

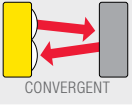
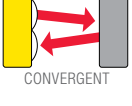
Sensing Mode	Range	Connection	Output Type	Models
 CONVERGENT	38 mm	2 m 4-Pin Euro QD	Constant Current ≤1.2 mA dark ≥2.1 mA light	Q45AD9CV Q45AD9CVQ
 CONVERGENT	100 mm	2 m 4-Pin Euro QD	Constant Current ≤1.2 mA dark ≥2.1 mA light	Q45AD9CV4 Q45AD9CV4Q

Glass & Plastic Fiber Q45, 5-15 V DC

 Infrared LED  Visible Red LED

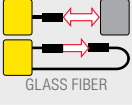
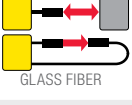
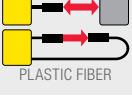
Sensing Mode	Range	Connection	Output Type	Models
 GLASS FIBER	Range varies by sensing mode and fiber optics used	2 m	Constant Current ≤1.2 mA dark ≥2.1 mA light	Q45AD9F
		4-Pin Euro QD		Q45AD9FQ
 GLASS FIBER	Range varies by sensing mode and fiber optics used	2 m	Constant Current ≤1.2 mA dark ≥2.1 mA light	Q45AD9FV
		4-Pin Euro QD		Q45AD9FVQ
 PLASTIC FIBER	Range varies by sensing mode and fiber optics used	2 m	Constant Current ≤1.2 mA dark ≥2.1 mA light	Q45AD9FP
		4-Pin Euro QD		Q45AD9FPQ

For more specifications see page 337.

 Connection options: A model with a QD requires a mating cordset (see page 336).

For 9 m cable, add suffix W/30 to the 2 m model number (example, Q459E W/30).



4-Pin

**Euro-Style NAMUR**  
Straight connector models listed;  
for right-angle, add **RA** to the end  
of the model number (example,  
**MQD9-406RA**)

**MQD9-406**  
2 m (6.5')  
**MQD9-415**  
5 m (15')



**SMB30MM**

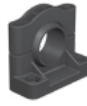

**SMB30SC**

*Additional cordset information is available  
See page 758*

*Additional bracket information is available  
See page 722*

**Reflectors**



*Additional information is available  
See page 790*

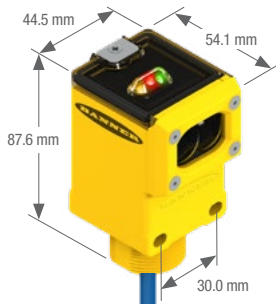

**Opposed, Retroreflective  
and Diffuse Models**  
Suffix E, R, D, DL, LV and LP



**Convergent Models**  
Suffix CV and CV4







**Plastic Fiber Model**  
Suffix FP



**Glass Fiber Models**  
Suffix F and FV



## Q45 NAMUR Specifications

Supply Voltage and Current	5 to 15 V dc. Supply voltage is provided by the amplifier to which the sensor is connected.
Output	<b>Constant current output:</b> $\leq 1.2$ mA in the dark condition and $\geq 2.1$ mA in the light condition
Output Response Time	<b>Opposed receiver:</b> 2 milliseconds ON/0.4 milliseconds OFF All others: 5 milliseconds ON/OFF (does not include amplifier response)
Adjustments	Multi-turn sensitivity control on top of sensor
Indicators	<b>Power (Red):</b> LED (emitters only) lights whenever 5 - 15 V dc power is applied <b>Signal (Red):</b> LED lights whenever the sensor sees its modulated light source
Construction	Molded thermoplastic polyester housing, o-ring sealed transparent Lexan® top cover, molded acrylic lenses, and stainless steel hardware. Q45s are designed to withstand 1200 psi washdown. The base of cabled models has a 1/2" NPS integral internal conduit thread.
Environmental Rating	IP67; NEMA 6P
Operating Conditions	<b>Temperature:</b> -40 to +70 °C <b>Relative humidity:</b> 90% at 50 °C (non-condensing)
Design Standards	Q45AD9 Series sensors comply with the following standards: DIN 19234, EN 50 014: 1977, EN 50 020: 2002
Certifications	    

Lexan® is a registered trademark of General Electric Co.

## APPROVALS

**CSA:** #LR 41887

Intrinsically Safe, with Entity for  
Class I, Groups A-D  
Class I, Div. 2, Groups A-D

**KEMA:** #03 ATEX 1441x

II IG EEx ia IICTC

**FM:** #J.I. 5Y3A4.AX

Intrinsically Safe, with Entity for  
Class I, II, III, Div. 1, Groups A-G  
Class I, II, III, Div. 2, Groups A-D and G

**ETL:** #558044      Tested per FM and CSA as shown above

## SMI30

## Long-Range Barrel Sensors for Hazardous Areas



- The SMI30 is an extremely rugged and powerful intrinsically safe barrel sensor designed for the most demanding hazardous area sensing applications
- Certified as intrinsically safe for use in hazardous atmospheres as defined by Article 500 of the National Electrical Code, when used with approved "positive input" intrinsic safety barriers
- Certified by Factory Mutual and CSA as non-incendive devices when used in Division 2 locations (except Groups E and F) without intrinsic safety barriers

SMI30 Frequency A<sup>†</sup>

Infrared LED

Sensing Mode	Range	Connection	Output Type	Response Time	Models
 OPPOSED	140 m	3-Pin Mini QD	— NPN/LO NPN/DO	10 ms	SMI306EQ SMI30AN6RQ SMI30RN6RQ
 OPPOSED	60 m	3-Pin Mini QD	— NPN/LO NPN/DO	1 ms	SMI306EYQ SMI30AN6RYQ SMI30RN6RYQ

## Intrinsic Safety Kits for Use with SMI30 Intrinsically Safe Sensors

Model	Description
C12BK-1	Includes a CI3RC2 current amplifier, one RS-11 socket, one DIN-rail mount and one single-channel intrinsically safe barrier
C12BK-2	Includes a CI3RC2 current amplifier, one RS-11 socket, one DIN-rail mount and one dual-channel intrinsically safe barrier
CI3RC2	Current trip point amplifier
C1B-1	Single channel intrinsic safety barrier
C12B-1	Dual channel intrinsic safety barrier



Connection options: A model with a QD requires a special Mini-style mating cordset.

<sup>†</sup> Modulation frequency "A" is standard; frequencies "B" and "C" are also available to minimize optical crosstalk potential between adjacent pairs and are specified by adding "B" or "C" at the end of the standard model number (example, SMI306EBQ or SMI306ECQ).



**Mini-Style**  
Straight connector models listed

3-Pin	4-Pin
<b>SMICC-306</b>	<b>MBCC-406</b>
2 m (6.5')	2 m (6.5')
<b>SMICC-312</b>	<b>MBCC-412</b>
4 m (12')	4 m (12')
<b>SMICC-330</b>	<b>MBCC-430</b>
9 m (30')	9 m (30')

Additional cordset information is available  
See page 758



**SMB30A**



**SMB30FA..**

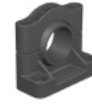

**SMBAMS30P**

Additional bracket information is available  
See page 724

**Reflectors**



Additional information is available  
See page 790





**Apertures**



Additional information is available  
See page 816



**SMI30 Specifications**

<b>Supply Voltage and Current</b>	<b>Emitters:</b> 10 to 30 V dc at 25 mA <b>Receivers:</b> 10 to 30 V dc at 15 mA max. Division 1 use, with barriers, requires minimum system supply voltage of 10 V.
<b>Supply Protection Circuitry</b>	Protected against reverse polarity and transient voltages
<b>Output Configuration</b>	<b>Receivers:</b> Current sinking NPN open-collector transistor
<b>Output Rating</b>	Three-wire hookup sinks 15 mA max. continuous, 10 to 30 V dc. Two-wire hookup sinks ≤10 mA
<b>Output Protection Circuitry</b>	Outputs are short circuit protected
<b>Output Response Time</b>	10 milliseconds or 1 millisecond ON/OFF, depending on models; independent of signal strength
<b>Repeatability</b>	"A" frequency units: 10 millisecond receiver is 1 milliseconds and 1 millisecond receiver is 360 microseconds "B" frequency units: 1.6 milliseconds "C" frequency units: 10 millisecond receiver is 2.3 milliseconds and 1 millisecond receiver is 210 microseconds Repeatability is independent of signal strength
<b>Indicators</b>	Internal Red LED lights whenever the receiver sees the emitter's modulated light source. Emitters have Red "power on" indicator LED. All indicators are visible through the lens or from side of the sensor.
<b>Construction</b>	30 mm diameter tubular threaded thermoplastic polyester housing, fully epoxy-encapsulated, positive sealing at both ends, quad-ring sealed acrylic lens. Two thermoplastic polyester jam nuts provided.
<b>Environmental Rating</b>	IP67; NEMA 6P
<b>Operating Conditions</b>	<b>Temperature:</b> -40 to +70 °C <b>Relative humidity:</b> 90% at 50° C (non-condensing)
<b>Certifications</b>	    
<b>Hookup Diagrams</b>	See data sheet for detailed Hookup Diagrams.



## Vision

Banner's extensive line of vision sensors helps you find defects earlier in the manufacturing process. Banner offers standard and high-resolution gray scale and color vision sensors. Add inspection capabilities where you need them.

# VISION

---

VISION SENSORS **page 342**

SMART CAMERAS **page 348**

VISION CONTROLLERS **page 358**

VISION LIGHTING **page 364**

# iVu TG and iVu Plus TG

## Image Sensor



- Image sensor combines the simplicity of a photoelectric sensor and the intelligence of a vision sensor, providing high-performance inspection capabilities at your fingertips
- All-inclusive image sensor with lens, light, IO and touch screen programming
- Optional remote touch screen for programming
- Profinet® communication protocol to simplify communications with some of the most commonly used industrial controllers in factory automation
- iVu Plus TG supports the ability to obtain results and command rapid product changeovers over TCP/IP, EtherNet/IP, Modbus/TCP protocols or PROFINET
- Ability to change parameters on the fly
- iVu Plus TG models have additional sort tools, multi-tool and the ability to store up to 30 inspections

- No PC required to configure, change or monitor
- Built-in or remote touch screen
- Self-contained sensor with easy configuration and convenient monitoring right on the sensor



Installation and configuration in four easy steps



1. Install and connect the sensor
2. Select the sensor or bar code type, depending on model
3. Acquire a good image
4. Set inspection parameters

Intuitive operation with menu driven tools to guide you through setup

- Define region of interest
- Adjust intensity/contrast
- Define the pass criteria



### iVu TG Sensor Types

#### Sensor Type



**Match Sensor** — Compares a part to a reference to determine if there is a match



**Area Sensor** — Detects whether a particular feature (features) are present



**Blemish Sensor** — Finds flaws on parts

#### Screen Interface Pass

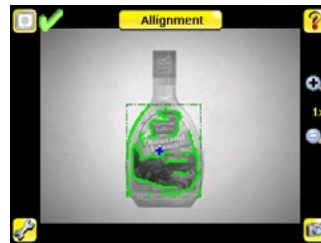

#### Screen Interface Fail

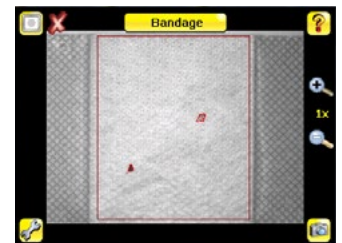
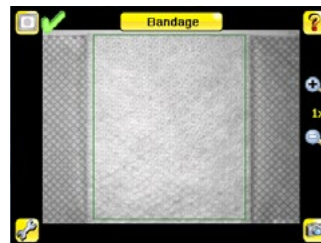
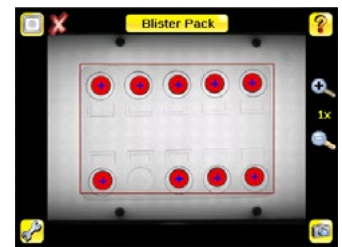
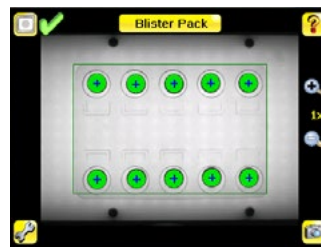





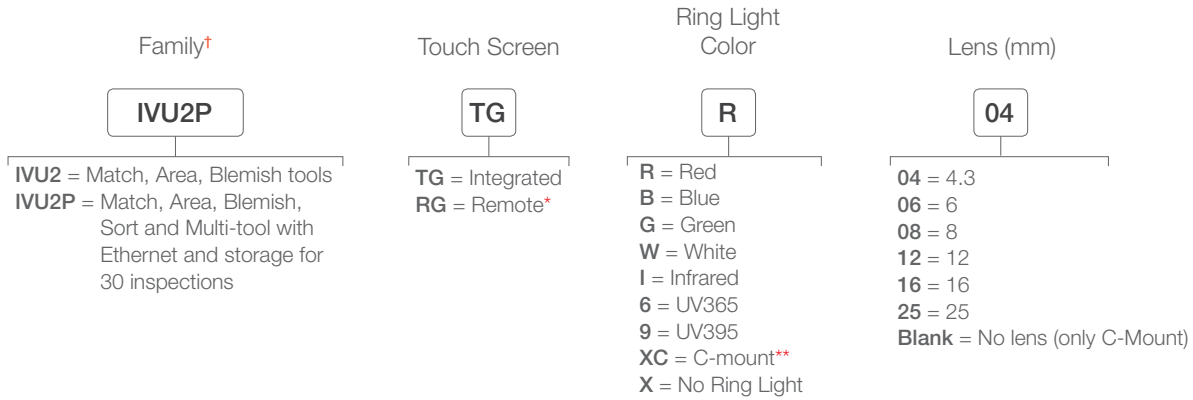

iVu TG

Example Model Number: IVU2PTGR04

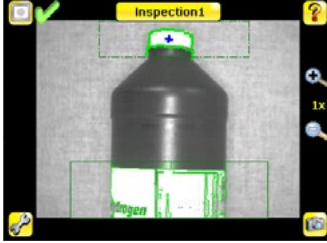

\* Remote display is required for set up and viewing of sensors with a remote touch screen. See page 346.  
 \*\* Requires C-mount lens. See page 362.

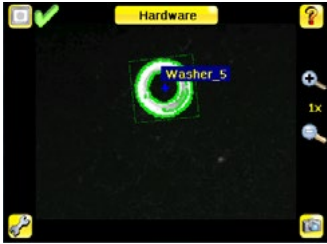
Additional iVu Plus TG (in addition to Standard TG Sensor Types)

Sensor Type	Screen Interface Pass	Screen Interface Fail
		
<p><b>Multi-Point Inspection (Plus only)</b> — Use seven to nine sensors in the same inspection</p>		
		
<p><b>Sort Sensor (Plus only)</b> — Recognize and sort up to ten different patterns in the same inspection</p>		

For more specifications see page 345.

Display and cordsets ordered separately.  
 † Barcode models available. See page 272.



**Power**  
**M12/Euro-Style with Shield**  
 Straight connector models listed; for right-angle, add **RA** to the end of the model number (example, **MQDC2S-1206RA**)

<p><b>8-Pin</b>  <b>MQDC2S-806</b>                  2 m (6.5')  <b>MQDC2S-815</b>                  5 m (15')  <b>MQDC2S-830</b>                  9 m (30')  <b>MQDC2S-850</b>                  15 m (50')</p>	<p><b>12-Pin</b>  <b>MQDC2S-1206</b>                  2 m (6.5')  <b>MQDC2S-1215</b>                  5 m (15')  <b>MQDC2S-1230</b>                  9 m (30')  <b>MQDC2S-1250</b>                  15 m (50')</p>
---	--

**Used With:** TG Models      TG Plus Models

**Ethernet**  
**RJ45 to 4-Pin Pico QD**

<p><b>4-Pin</b>  <b>IVUC-E-406</b>                  2 m (6.5')  <b>IVUC-E-415</b>                  5 m (15')  <b>IVUC-E-430</b>                  9 m (30')</p>	<p><b>IVUC-E-450</b>                  12 m (50')  <b>IVUC-E-475</b>                  23 m (75')</p>
--	---

**Used with:** TG Plus only

Additional cordset information is available. See page 758

**USB**  
 Straight connector models listed

<p><b>8-Pin Euro**</b>  <b>MQDEC-8005-USB</b>                  0.15 m (0.5')  <b>MQDEC-801-USB</b>                  0.3 m (1')  <b>MQDEC-803-USB</b>                  0.9 m (3')  <b>MQDEC-810-USB</b>                  3 m (10')</p>	<p><b>4-Pin Pico</b>  <b>PSG-4M-4005-USB</b>                  0.15 m (0.5')  <b>PSG-4M-401-USB</b>                  0.3 m (1')  <b>PSG-4M-403-USB</b>                  0.9 m (3')  <b>PSG-4M-410-USB</b>                  3.0 m (10')</p>
---	---

**Used with:** TG with Integrated Touch Screen      TG with Remote Touch Screen

\*\* For right-angle, add **RA** in the middle of the model number (example, **MQDEC-801RA-USB**)

						
<b>SMBIVURAL</b>	<b>SMBIVURAR</b>	<b>SMBIVUU</b>	<b>SMBIVUB</b> TG model only	<b>SMBRD35</b>	<b>SMBKS</b>	<b>SMBRDM35</b>

**Used with:** Remote Display Screens

Additional bracket information is available. See page 726



81.2 mm  
 52.3 mm  
 95.3 mm

(front)



(back)

**Sensors with Integrated Touch Screen (Standard iVu model shown)**

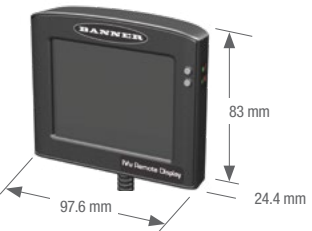

83 mm  
 97.6 mm  
 24.4 mm



**RDM35**

**RD35 Remote Touch Screen (sold separately)**



**Sensors with Remote Touch Screen**

iVu & iVu Plus Specifications

General	
Supply Voltage	10-30 V dc
Demo Mode	Full tool functionality on canned images
Sensor Lock	Optional password protection
Integrated Ring Light	Red, IR, Green, Blue, White, UV or no integrated ring light
Imager	1/3 inch CMOS 752 x 480 pixels; adjustable Field-of-View (FOV)
Lens Mount	M12 X 1 mm thread (c-mount lens); microvideo lens 4.3, 6, 8, 12, 16, 25 mm
Output Rating	150 mA
Exposure Time	0.1 milliseconds to 1.049 seconds
Construction	Black Valox™ sensor housing; acrylic window <b>iVu Plus Integrated:</b> Die cast zinc and Black Valox™
External Strobe Output	+ 5 V dc
Environmental Rating	IP67
Model Specific	
Power Connection	<b>iVu TG</b> (integrated and remote touch screen): 8-pin Euro-style (M12) male connector Accessory cordset required for operation; QD cordsets are ordered separately. <b>iVu Plus TG</b> (integrated and remote touch screen): 12-pin Euro-style (M12) male connector
Supply Current	<b>iVu TG:</b> 800 mA max. (exclusive of I/O load) <b>iVu Plus TG:</b> 850 mA max. (exclusive of I/O load)
USB 2.0 Host	<b>iVu TG</b> (integrated touch screen): 8-pin Euro-style (M12) female connector <b>iVu TG</b> (remote touch screen): 4-pin Pico-style (M8) female connector <b>iVu Plus TG</b> (integrated and remote touch screen): 4-pin Pico-style (M8) female connector Optional USB cordset required for operation of USB Thumb Drive. QD cordsets are ordered separately.
Ethernet Connection	<b>iVu Plus TG:</b> 4-pin Pico-style (M8) male connector. Ethernet cordsets are ordered separately.
Output Configuration	NPN or PNP, software on-screen selectable
Tools	<b>iVu TG:</b> Area, Blemish and Match <b>iVu Plus TG:</b> Area, Blemish, Match and Sort
Display	<b>Integrated touch screen:</b> 68.5 mm (2.7") LCD Color Integrated Display 320 x 240 pixels <b>Remote touch screen:</b> See RD35 Remote Display specifications
Acquisition	<b>iVu TG:</b> 100 fps (frames per second) max. <b>iVu Plus TG:</b> 100 fps (frames per second) max.
Operating conditions	<b>Stable Ambient Temperature:</b> <b>TG:</b> 0 to + 50 °C <b>iVu Plus TG</b> (integrated touch screen): 0 to +45 °C <b>iVu Plus TG</b> (remote touch screen): 0 to +40 °C
Remote Display connection (Remote Touch Screen Models Only)	8-pin Euro-style (M12) female connector Accessory cordset required for remote display; QD cordsets are ordered separately.
Certifications	 <b>NOTE:</b> <b>iVu Plus</b> remote must use Euro QD power cordset for CE compliance. 

iVu Remote Display Specifications

Screen Size	3.5" diagonal
LCD Aspect Ratio	4:3
Display Resolution	320 x 240 RGB
Viewing Angle	60 degrees left, and 60 degrees right, 50 degrees up, and 55 degrees down
Housing Material	Zinc Zamac #3 (RDM35), Polycarbonate (RD35)
Bracket Material	Delrin (RD35), ABS (RDM35)
Stylus	Delrin
Display Weight	4.8 oz (RD35), 12 oz (RDM35)
Bracket & Stylus Weight	1.1 oz
Connection	Molex HandyLink connector
Operating Temperature	0° to + 40° C

Remote Display Touch Screen

Description	Model
3.5" diagonal remote touch screen — Machine-mountable	RDM35
3.5" diagonal remote touch screen — Handheld	RD35

RDM35 Accessory Kits



**RDM35**  
Machine-mountable Remote Display  
Used for- programming & monitoring

Description	Straight	Right-Angle
1 m cordset, bracket/docking station, stylus and hardware	IVURDM-QDK-803	IVURDM-QDK-803RA
2 m cordset, bracket/docking station, stylus and hardware	IVURDM-QDK-806	IVURDM-QDK-806RA
5 m cordset, bracket/docking station, stylus and hardware	IVURDM-QDK-815	IVURDM-QDK-815RA
9 m cordset, bracket/docking station, stylus and hardware	IVURDM-QDK-830	IVURDM-QDK-830RA
16 m cordset, bracket/docking station, stylus and hardware	IVURDM-QDK-850	IVURDM-QDK-850RA

RD35 Accessory Kits



**RD35**  
Handheld Remote Display  
Used for programming

Description	Straight	Right-Angle
1 m cordset, bracket/docking station, stylus and hardware	IVURD-MXK-803	IVURD-MXK-803RA
2 m cordset, bracket/docking station, stylus and hardware	IVURD-MXK-806	IVURD-MXK-806RA
5 m cordset, bracket/docking station, stylus and hardware	IVURD-MXK-815	IVURD-MXK-815RA
9 m cordset, bracket/docking station, stylus and hardware	IVURD-MXK-830	IVURD-MXK-830RA
16 m cordset, bracket/docking station, stylus and hardware	IVURD-MXK-850	IVURD-MXK-850RA

Cordsets for Remote Display

Hand Held Remote Display (RD35)		Machine Mountable Remote Display (RDM35)	
8-Pin		8-Pin	
<b>Double Ended M12/Euro-Style</b> Straight connector models listed; for right-angle, add <b>RA</b> to the end of the model number (example, <b>IVURD-QD-803RA</b> )	<b>IVURD-QD-803</b> 1 m (3') <b>IVURD-QD-806</b> 2 m (6') <b>IVURD-QD-815</b> 5 m (15') <b>IVURD-QD-830</b> 9 m (30') <b>IVURD-QD-850</b> 16 m (50')	<b>Euro-Style to Molex</b> Straight connector models listed; for right-angle, add <b>RA</b> to the end of the model number (example, <b>IVURD-MX-803RA</b> )	<b>IVURD-MX-803</b> 1 m (3') <b>IVURD-MX-806</b> 2 m (6') <b>IVURD-MX-815</b> 5 m (15') <b>IVURD-MX-830</b> 9 m (30') <b>IVURD-MX-850</b> 16 m (50')

Additional cordset information is available  
See page 758



SMBRD35



SMBKS



SMBRDM35

Lenses



Lens	Model
4.3 mm	LMF04
6 mm	LMF06
8 mm	LMF08
12 mm	LMF12
16 mm	LMF16
25 mm	LMF25*

Used with: iVu and iVu Plus

\* 25 mm filter holder is purchased separately.

Filter Kits†



Filter	Model
Red	FLTMR2
Blue	FLTMB
Green	FLTMG
Infrared	FLTMI*

Used with: iVu and iVu Plus

\* Infrared pass filters are preinstalled on infrared ring light models.

† Filter kits include 1 color and two sizes of filter holders.

Replacement Windows

Focusing ring with optically clear glass  
Focusing ring with plastic window  
Replacement cover for touch screen

Model
IVUW-G
IVUW
IVUBC

Used with: iVu and iVu Plus

Sensor Interface Module



**IVUSIM**  
For simplified wiring of iVu sensors in an electrical box

2 GB USB Drive



IVU-USBFD2

Stylus



Model
STYLUS-1 (Qty 1)
STYLUS-10 (Qty 10)

C-Mount Lens Covers



Description	Model
Lens cover 50 mm — plastic window	IVUSLC50-P
Lens cover 75 mm — plastic window	IVUSLC75-P

Accessories for C-Mount Lenses\*

Description	Format Size	Model	Used With
Extension Kit (0.5, 1.0, 5.0, 10, 20 and 40 mm)	—	LEK	All Lenses
Extension Kit (0.25 and 0.5 mm)		LEKS	
Lens Extender (increases focal length 2X)		LCF2X	
UV Lens Filter, Clear Glass	2/3"	FLTUV	Tamron Megapixel Lenses

Bandpass Filters Example Model Number: FLTB470-27

Description	Model	Diameter
Blue	FLTB470-	25.5 27 30.5 34 43
Green	FLTG525-	
Infrared	FLT1850-	
Red	FLTR635-	
Dark Red	FLTBR660-	
Polarizing filter	FLTPR032-	

C-Mount Color Filters\*



Color	Description	Plastic Models	Glass Models
Infrared	High-pass filter blocks visible light and passes infrared light. Included with all Banner Infrared light sources.	FLTI (> 760 nm)	FLT1850 (810-990 nm)
Blue	Band-pass filter improves quality by helping to reduce ambient light; it passes blue and infrared light.	FLTB (400-525 nm)	FLTB470 (435-490 nm)
Green	Band-pass filter improves quality by helping to reduce ambient light; it passes green and infrared light.	FLTG (400-575 nm)	FLTG525 (495-565 nm)
Red	High-pass filter improves quality by helping to reduce ambient light; it passes red and infrared light.	FLTR (> 600 nm)	FLTR635 (600-660 nm)
Dark Red	High-pass filter improves quality by helping to reduce ambient light; it passes red and infrared light.	—	FLTR660 (650-680 nm)



\* For C-Mount lenses see page 362



---

## Vision Cameras

Banner's Vision Cameras include a comprehensive family of vision systems that addresses a wide range of application needs, including high resolution and high speed inspections. One- or two-piece systems are available with a complete suite of location, inspection and analysis tools that can be used simultaneously for inspecting multiple features and solving complex applications.

Series	Description	Integrated I/O	Memory	Protection Rating	Construction	Power Supply
	<p><b>VE Series Smart Camera</b> Combine powerful inspection tools and capabilities with ease of use to maximize inspection uptime and facilitate rapid implementation. page 350</p>	6	500 MB	IEC IP67	<p><b>Housing:</b> Aluminum <b>Display Label:</b> Polyester</p>	12 to 30 V dc
	<p><b>PresencePLUS P4</b> One piece sensor with a complete suite of location, inspection and analysis of tool can be used simultaneously for inspecting multiple features and solving complex applications. page 354</p>	7	64 MB	IEC IP20 NEMA 1 IP68	<p><b>Housing:</b> Black anodized aluminum, die cast nickel-plated aluminum <b>Lens:</b> Glass</p>	10 to 30 V dc
	<p><b>PresencePLUS Pro II Camera Heads</b> One part of a two piece system with a complete suite of location, inspection and analysis tools can be used simultaneously for inspecting multiple features and solving complex applications. page 358</p>	14	64 MB	<p><b>Camera:</b> IP20 or IP68 <b>Controller:</b> IP20</p>	<p><b>Camera:</b> Black anodized aluminum, Nickel-plated aluminum, 316 stainless <b>Controller:</b> Steel with zinc plating</p>	10 to 30 V dc

# VE Series

## Versatile, Easy-To-Use Smart Cameras



- Available in 2MP (1600 x 1200 pixels), 1.3MP (1280 x 1024 pixels) and WVGA (752 x 480 pixels) models, all with the same powerful inspection capabilities
- Runtime editing capability reduces costly downtime and the software emulator allows for offline building and troubleshooting of applications
- Factory communications (EtherNet/IP, Modbus/TCP, PROFINET and RS-232 Serial) for integration on the manufacturing floor
- Two-line, eight-character onboard display provides inspection information and focus number and makes it easy to update sensor settings, facilitating fast product changeover
- Robust metal housing with optional lens covers to achieve IP67 rating for use in harsh environments with heat, vibration, or moisture

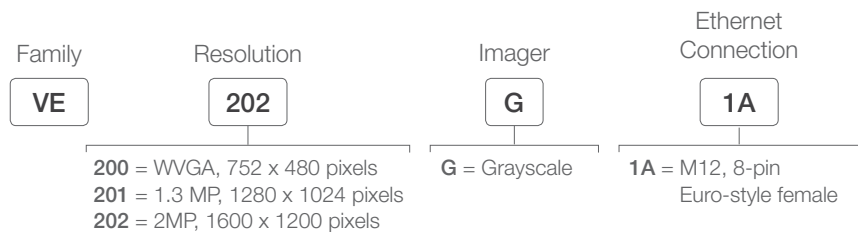



# VE Vision Manager software: Easy configuration, powerful functions.

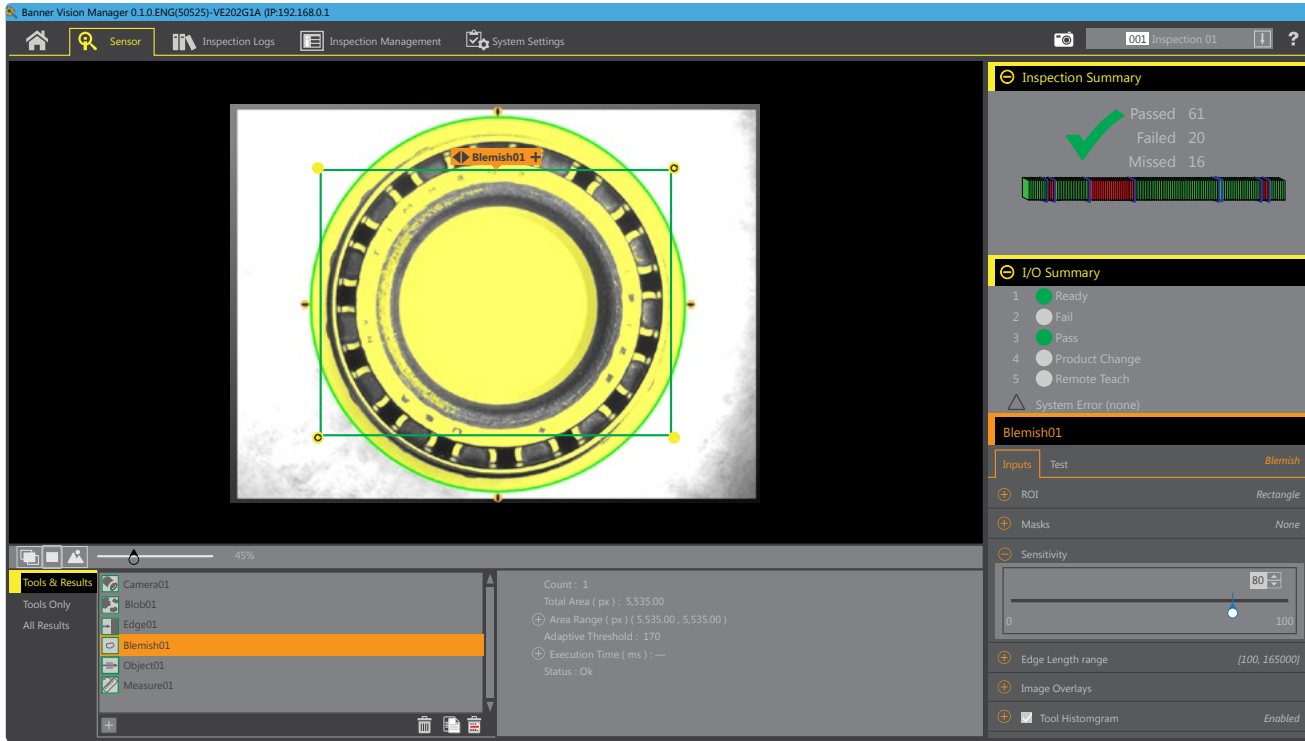

## Runtime Editing

Easy-to-use configuration software with full runtime editing allows for changes to be made quickly with no costly downtime from stopping and starting inspections. Start using today by downloading at [www.bannerengineering.com/vision-manager](http://www.bannerengineering.com/vision-manager).

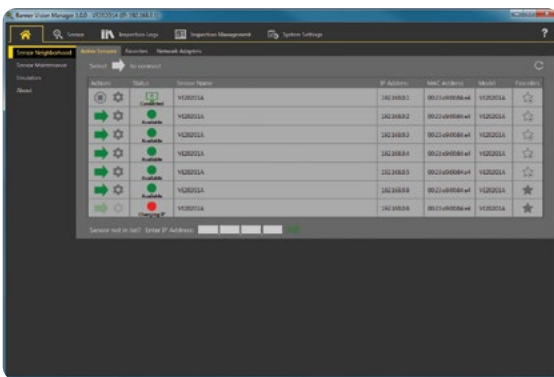

## Full Software Emulator

Connect to multiple cameras or full software emulator for building inspections offline



## Inspection Analysis

Review past inspection results, view system logs, and quickly configure inputs and outputs

## Factory Communications

Seamlessly interface with the factory floor using EtherNet/IP, Modbus/TCP, PROFINET and RS-232 Serial communications

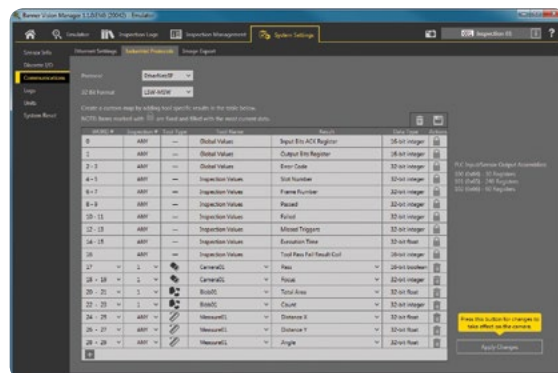



12-Pin

- MQDC2S-1206**  
2 m (6')
- MQDC2S-1215**  
4 m (15')
- MQDC2S-1230**  
9 m (30')
- MQDC2S-1250**  
15 m (50')
- MQDC2S-1275**  
23 m (75')

**Euro QD with Open Shield**

Straight connector models listed; for right-angle, add **RA** at the end of the model number (example, **MQDC2S-1206RA**)



RJ45 to Ethernet 8-pin threaded M12 Euro (Cat5e shielded)

- STP-M12-806**  
2 m (6')
- STP-M12-815**  
4 m (15')
- STP-M12-830**  
9 m (30')



**SMBVERA**



**SMBVEMP**  
Mounting plate with M8x1.25, 10-32, and 1/2-20 adapter holes

Additional cordset information is available. See page 758

Additional bracket information is available. See page 726

**Bandpass Filters**

Example Model Number: FLTB470-27



Optional filters create additional contrast

Description	Model	Diameter
Blue	FLTB470-	25.5
Green	FLTG525-	27
Infrared	FLTI850-	30.5
Red	FLTR635-	34
Dark Red	FLTBR660-	43
Polarizing Filter	FLTPR032-	

Used with: iVu, PresencePLUS, VE



Additional C-mount Lens information is available. See page 362

**Sealed Lens Covers**

Type	Model
60 mm cover with polycarbonate window	VELC60-PC
60 mm cover with borosilicate glass window	VELC60-BG
85 mm cover with polycarbonate window	VELC85-PC
85 mm cover with borosilicate glass window	VELC85-BG



**Display Cover**

Type	Model
Protective display cover with borosilicate glass window	VEDC-BG



VE Series Specifications

Power	12 to 30 V dc <b>Current:</b> 400 mA maximum (exclusive of load and lights) Use only with a suitable Class 2 power supply, or current limiting power supply rated 12 V dc to 30 V dc, 1 A	
Discrete I/O	1 Trigger IN 5 programmable I/O	
Output Configuration	Optically isolated	
Output Rating	<b>Output Resistance:</b> < 2 Ω <b>Programmable Output:</b> 100 mA <b>Off-State Leakage Current:</b> < 100 μA	<b>Strobe Output Resistance:</b> < 13 Ω <b>External Strobe Output:</b> 100 mA
External Light Max. Current Draw	600 mA	
Exposure Time	0.02 ms to 500 ms	
Imager	<b>VE200G1A:</b> 6.9 mm × 5.5 mm, 8.7 mm diagonal (1/1.8-inch CMOS) <b>VE202G1A:</b> 7.2 mm × 5.4 mm, 9.0 mm diagonal (1/1.8-inch CMOS)	<b>VE201G1A:</b> 6.9 mm × 5.5 mm, 8.7 mm diagonal (1/1.8-inch CMOS) <b>VE202G2A:</b> 7.2 mm × 5.4 mm, 9.0 mm diagonal (1/1.8-inch CMOS)
Lens	C-mount	
Pixel Size	<b>VE200G1A:</b> 5.3 μm <b>VE202G1A:</b> 4.5 μm	<b>VE201G1A:</b> 5.3 μm <b>VE202G2A:</b> 4.5 μm
Communication	10/100/1000 Mbps Ethernet, Serial RS-232	
Memory	<b>Device Settings and Inspection Storage Memory:</b> 500 MB <b>Number of Inspection Files:</b> 999	
Acquisition	256 grayscale levels <b>Frames per Second:</b> <b>VE202G1A:</b> 50 fps, max. depending on inspection settings <b>VE202G2A:</b> 50 fps, <b>VE200G1A:</b> 60 fps, <b>VE201G1A:</b> 60 fps  <b>Image Size:</b> 752 x 480 pixels = VE200G1A 1280 x 1024 pixels = VE201G1A 1600 x 1200 pixels = VE202G1A, VE202G2A	
Construction	<b>Housing:</b> Aluminum <b>Display Label:</b> Polyester	
Connections	<b>Communications:</b> M12, 8-pin Euro-style male <b>Light Connector:</b> M8, 3-pin Pico-style female <b>Power, Discrete I/O:</b> M12, 12-pin Euro-style female	
Environmental Rating	IEC IP67 with optional lens cover	
Operating Conditions	<b>Temperature:</b> 0 °C to +50 °C (+32 °F to +122 °F) 95% maximum relative humidity (non-condensing) <b>Stable Ambient Lighting:</b> No large, quick changes in light level; no direct or reflected sunlight <b>Storage Temperature:</b> -30 to +70 °C (-22 to +158 °F)	
Vibration and Mechanical Shock	Meets EN 60947-5-2: 30 G Shock per IEC 60068-2-27; 1 mm amplitude from 10-60 Hz per IEC 60068-2-6	
Software Tools	Average Gray, Bead, Blemish, Blob, Edge, Locate, Logic, Match, Math, Measure, Object, Line Detect, Circle Detect	
Certifications	 	

# P4 OMNI

## Full-Featured Vision System



- Economical one-piece design
- Premium tools for enhanced inspection capabilities
- VGA, color and 1.3 MP models available
- Three bright bicolor LED indicators
- Seven configurable discrete I/O (NPN/PNP)
- Cordsets and brackets see page 356

### P4 OMNI

Example Model Number: P40R-BD

#### Sensor

**P40**

**P40** = 640 x 480 Gray Scale  
**P401.3** = 1280 x 1024 Gray Scale  
**P4CO** = 752 x 480 Color & Gray Scale

#### Housing

**R**

**R** = Right-Angle  
**I** = In-Line

#### Premium Tools

**BD**

**BC** = Bar Code Reader  
**BD** = Bead Tool  
**OC** = OCR/OCV  
**BCBD** = Bar Code Reader & Bead Tool  
**BCOC** = BarCode & OCR/OCV  
**BDOC** = Bead Tool & OCR/OCV  
**BCBDOC** = Bar Code Reader,  
 Bead Tool & OCR/OCV

# P4 OMNI Sealed

## Rugged Full-Featured Vision System



- Economical one-piece design
- IP68-rated nickel-plated aluminum housing
- Premium tools for enhanced inspection capabilities
- VGA, color and 1.3 MP models available
- Three bright bicolor LED indicators
- Seven configurable discrete I/O (NPN/PNP)
- Cordsets and brackets see page 356

### IP68 P4 OMNI

Example Model Number: P4ORS-BD

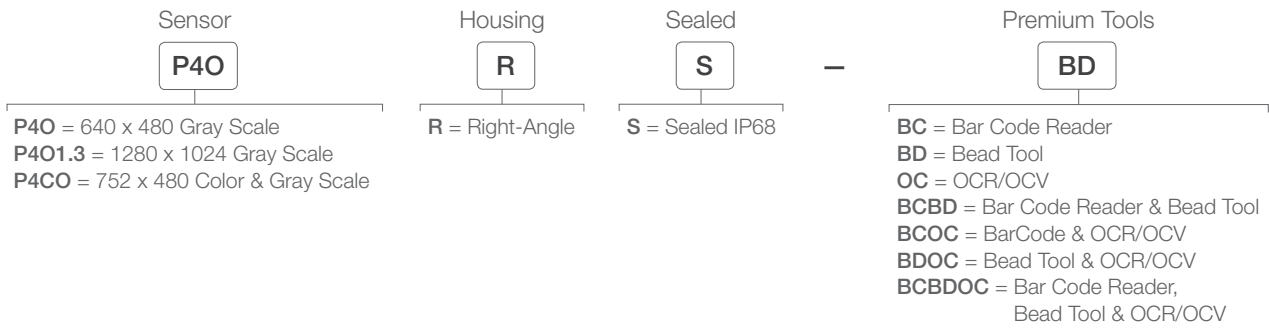



**Euro QD**  
Straight connector  
models listed

- 12-Pin**
- P4C06**  
2 m (6.5')
  - P4C13**  
4 m (13')
  - P4C23**  
7 m (23')
  - P4C32**  
10 m (32')
  - P4C50**  
15 m (50')
  - P4C75**  
23 m (75')
  - P4C110**  
34 m (110')

Used for: Power (P4)



**Euro QD**  
Straight connector  
models listed; for  
right-angle, add **RA**  
at the end of the model  
number  
(ex, MQDC2S-1206RA)

- 12-Pin**
- MQDC2S-1206**  
2 m (6.5')
  - MQDC2S-1215**  
5 m (15')
  - MQDC2S-1230**  
9 m (30')
  - MQDC2S-1250**  
15 m (50')
  - MQDC2S-1275**  
23 m (75')

Used for: Power (Sealed P4)

**BNC to BNC**

- BNC06**  
2 m (6.5')
- BNC15**  
5 m (16')
- BNC30**  
9 m (30')
- BNC48**  
15 m (49')

Used for: Video (P4)

**QD to BNC**

- PKG4M-2/CS**  
2 m (6.5')
- PKG4M-5/CS**  
5 m (16')
- PKG4M-9/CS**  
9 m (30')

Used for: Video (Sealed P4)

**RJ45 to RJ45**

- |                            |                             |
|----------------------------|-----------------------------|
| <b>Shielded</b>            | <b>Shielded Crossover</b>   |
| <b>STP07</b><br>2 m (6.5') | <b>STPX7</b><br>2 m (6.5')  |
| <b>STP25</b><br>7 m (23')  | <b>STPX25</b><br>7 m (23')  |
| <b>STP50</b><br>15 m (50') | <b>STPX50</b><br>15 m (50') |
| <b>STP75</b><br>23 m (75') | <b>STPX75</b><br>23 m (75') |

Used for: Ethernet Communication (P4)

**RJ45 to 8-pin Euro QD—Sealed**  
Straight connector models  
listed; for right-angle, add  
**RA** at the end of the model  
number (example,  
**STP-MAQDC-806RA**)

- STP-MAQDC-806**  
2 m (6.5')
- STP-MAQDC-815**  
5 m (15')
- STP-MAQDC-830**  
9 m (30')

Used for: Ethernet Communication (Sealed P4)

Additional cordset information is available.  
See page 758



IP68-Rated Right-Angle Models  
(shown with cover and lens—sold separately)



Right-Angle Sensor Models  
(shown with lens—sold separately)



In-line Sensor Models  
(shown with lens—sold separately)

## PresencePLUS® P4 OMNI Specifications

Supply Voltage and Current	10 to 30 V dc (24 V dc $\pm$ 10% if the sensor powers a light source) P4OR, P4OI & P4ORS: less than 650 mA (exclusive of lights and I/O load) P4O1.3R, P4O1.3I, P4COR, P4COI, P4CORS & P4O1.3RS: less than 550 mA (exclusive of lights and I/O load)
Memory	32 MB or 64 mb Inspection (jobs): 999 max.
Input/Output Configuration	NPN (sinking) or PNP (sourcing) software selectable
Output Rating	150 mA max. each output OFF-state leakage current: less than 100 $\mu$ A ON-state saturation voltage: NPN—less than 1 V @ 150 mA max. PNP—greater than $V_+$ -2 V
Bicolor Status Indicators	PASS/FAIL: Green ON steady—PASS POWER/ERROR: Green ON steady—POWER READY/TRIGGER: Green ON steady—READY Red ON steady—FAIL Red ON steady—ERROR Yellow ON steady—TRIGGER
Display Options	PC or NTSC video (uses 9 m max. BNC cordset)
Discrete I/O	1 Trigger IN 1 Strobe OUT 4 Programmable I/O 1 Product Change IN 1 Remote TEACH IN
Communications	10/100 Ethernet connection for running PresencePLUS P4 software and/or output inspection results P4OR, P4OI, P4O1.3R, P4O1.3I, P4COR & P4COI: RJ-45 connector P4ORS, P4O1.3RS & P4CORS: 8-pin M12/Euro-style (female) connector RS-232 connection for output of inspection results
Imager Resolution	P4OR, P4OI & P4ORS: 640 x 480 pixels P4O1.3R, P4O1.3I & P4O1.3RS: 1280 x 1024 pixels P4COR, P4COI & P4CORS: 752 x 480 pixels
Pixel Size	P4OR, P4OI, P4COR, P4COI & P4ORS: 7.4 x 7.4 $\mu$ m P4O1.3R, P4O1.3I & P4O1.3RS: 6.7 x 6.7 $\mu$ m P4CORS: 6.0 X 6.0 $\mu$ m
Imager Size	P4OR, P4OI & P4ORS: 4.8 x 3.6 mm, 5.9 mm diagonal (1/3 inch CCD) P4O1.3R, P4O1.3I & P4O1.3RS: 8.6 x 6.9 mm, 11 mm diagonal (2/3 inch CMOS) P4COR, P4COI & P4CORS: 4.5 x 2.9 mm, 5.4 mm diagonal (1/3 inch CMOS)
Levels of Gray Scale or Color	P4OR, P4OI, P4O1.3R, P4O1.3I, P4ORS & P4O1.3RS: 256 Gray Scale P4COR, P4COI & P4CORS: 256 Red, Green and Blue
Exposure Time	P4OR, P4OI & P4ORS: 0.1 to 2830 milliseconds P4O1.3R, P4O1.3I & P4O1.3RS: 0.1 to 1670 milliseconds P4COR, P4COI & P4CORS: 0.1 to 1000 milliseconds
Full Image Acquisition	P4OR, P4OI & P4ORS: 48 frames per second max.* P4O1.3R, P4O1.3I & P4O1.3RS: 26.8 frames per second max.* P4COR, P4COI & P4CORS: 17 frames per second max.*
Lens Mount	Standard C-mount (1 inch—32 UN)
Construction	P4OR, P4OI, P4O1.3R, P4O1.3I, P4COR & P4COI: Black anodized aluminum housing, glass lens P4ORS, P4O1.3RS & P4CORS: Die-cast nickel-plated aluminum housing, glass or acrylic window
Weight	P4OI, P4O1.3I & P4COI: 293 g P4OR, P4O1.3R & P4COR: 385 g P4ORS, P4O1.3RS & P4CORS: 430 g
Environmental Rating	P4OR, P4OI, P4O1.3R, P4O1.3I, P4COR & P4COI: IEC IP20; NEMA 1 P4ORS, P4O1.3RS & P4CORS: IEC IP68
Operating Conditions	Stable ambient temperature: 0 to +50 °C Stable ambient lighting: No large, quick changes in light level; no direct or reflected sunlight Relative humidity: P4OR, P4OI, P4O1.3R, P4O1.3I, P4COR & P4COI: 35-90% (non-condensing)
Tools	Color Only: Average Color, Color Blob, Color Match Standard: Average Grayscale, Blob Detect, Edge, GEO Count, Object, Pattern Count, Circle Detect, Line Detect, GEO Find, Locate, Pattern Find, Blob Find, Communication, Math, Measure, Test, String Premium: Bar Code, Bead Tool, OCR/OCV
Certifications	

\* A reduced Field-of-View (FOV) dramatically increases acquisition rates.



# PresencePLUS® Proll

## Full-Featured Vision System



- Compact camera with separate DIN-mountable controller
- Ethernet, serial and flexible discrete I/O
- A choice of standard or mini anodized aluminum camera, or washdown, IP68-rated nickel-plated aluminum or stainless steel cameras
- VGA, color and 1.3 MP models available
- Six bright bicolor LED indicators
- Premium tools for enhanced inspection capabilities

### Proll Controller

Example Model Number: PPROCTL-BD

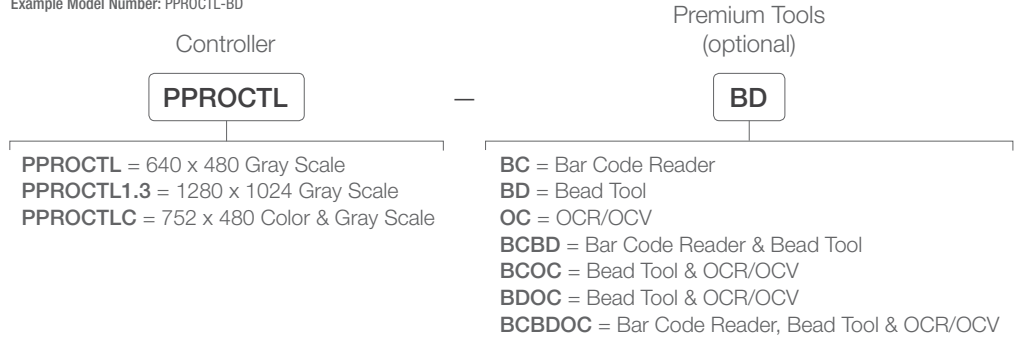

### Proll Camera

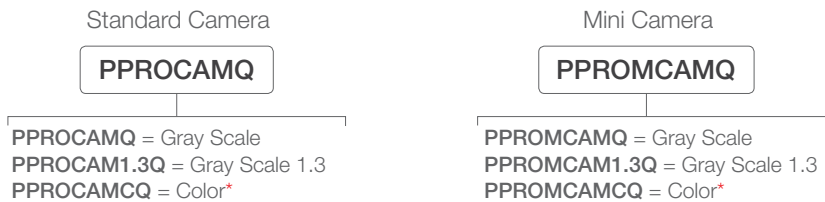

### IP68 Sealed Proll Camera

Example Model Number: PPROCAMSC-G

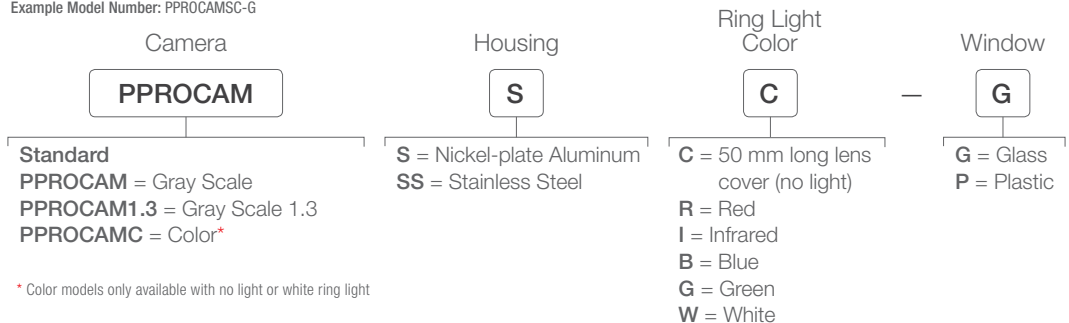

\* Color models only available with no light or white ring light

**Euro QD to DB15**

Straight connector models listed; for right-angle, add **RA** after the "S" in the model number (example, **PPC06SRAHF**)

**12-Pin**

- PPC06SHF**  
2 m (6.5')
- PPC13SHF**  
4 m (13')
- PPC23SHF**  
7 m (23')
- PPC32SHF**  
10 m (32')

**Used for:** Camera-to-Controller

**BNC to BNC**

- BNC06**  
2 m (6.5')
- BNC15**  
5 m (16')
- BNC30**  
9 m (30')
- BNC48**  
15 m (49')

**Used for:** Video

**DB9 to DB9**

- DB9P06**  
2 m (6.5')
- DB9P15**  
5 m (16')
- DB9P30**  
9 m (30')

**Used for:** Serial Communication

**RJ45 to RJ45**

**Shielded**

- STP07**  
2 m (6.5')
- STP25**  
7 m (23')
- STP50**  
15 m (50')
- STP75**  
23 m (75')

**Shielded Crossover**

- STPX7**  
2 m (6.5')
- STPX25**  
7 m (23')
- STPX50**  
15 m (50')
- STPX75**  
23 m (75')

**Used for:** Ethernet Communication

Additional cordset information is available.  
See page 758

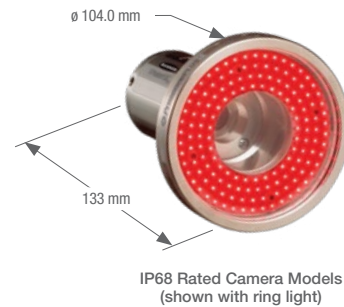
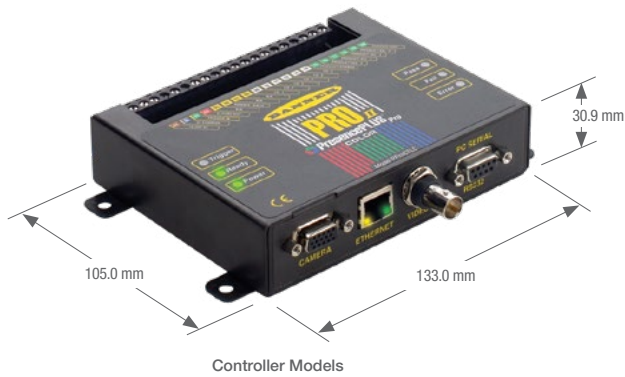

## PresencePLUS® Proll Controller Specifications

Supply Voltage and Current	<b>PPROCTL:</b> 10 to 30 V dc @ less than 1.5 A (exclusive of load) <b>PPROCTL1.3 &amp; PPROCTL1.3S:</b> 10 to 30 V dc @ less than 1.2 A (exclusive of load)
Supply Protection Circuitry	Protected against reverse polarity and transient voltages
Memory	<b>Storage:</b> 64 MB <b>Inspections (jobs):</b> 999 max.
Input/Output Configuration	NPN (sinking) or PNP (sourcing) software selectable
Output Rating	150 mA max. each output OFF-state leakage current: less than 100 µA ON-state saturation voltage: NPN—less than 1 V @ 150 mA    PNP—greater than V+ -2 V
Input Specifications	<b>NPN:</b> ON—less than 3 V OFF-state voltage—greater than 10 V @ 4 mA max <b>PNP:</b> ON—greater than (+V -2)V @ 1 mA max. OFF-state voltage—less than 3 V @ 6 mA max.
Indicators	<b>6 LED indicators:</b> Trigger, Ready, Power, Pass, Fail, Error
Display Options	PC or NTSC video (uses 9 m max. BNC cordset)
Discrete I/O	1 Trigger IN (pin 3), 1 Strobe OUT (pin 4), 1 Remote TEACH IN (pin 6), 6 Programmable I/O (pins 9-14), 1 Product Change IN (pin 15), 4 Product Select IN (pins 16-19)
Communications	1 RJ-45 10/100 Ethernet connection for running PresencePLUS Pro software and/or output inspection results 1 RS-232 DB-9 port for output of inspection results
Construction	Steel with black zinc plating
Weight	Approx. 0.55 kg
Environmental Rating	IEC IP20; NEMA 1
Operating Conditions	<b>Stable Ambient Temperature:</b> 0 to +50 °C <b>Relative Humidity:</b> 90% (non-condensing) <b>Stable Ambient Lighting:</b> No large, quick changes in light level; no direct or reflected sunlight
Certifications	

## PresencePLUS® Proll Camera Specifications

Image Resolution	<b>PPROCAMQ &amp; PPROCAMS(S):</b> 640 x 480 pixels <b>PPROMCAMQ, PPROMCAMCQ, PPROCAMCQ &amp; PPROCAMCS(S):</b> 752 x 480 pixels <b>PPROMCAM1.3Q, PPROCAM1.3Q &amp; PPROCAM1.3S(S):</b> 1280 x 1024 pixels
Pixel Size	<b>PPROCAMQ &amp; PPROCAMS(S):</b> 7.4 x 7.4 µm <b>PPROMCAMQ, PPROMCAMCQ, PPROCAMCQ &amp; PPROCAMCS(S):</b> 6.0 x 6.0 µm <b>PPROMCAM1.3Q, PPROCAM1.3Q &amp; PPROCAM1.3S(S):</b> 6.7 x 6.7 µm
Imager Size	<b>PPROCAMQ &amp; PPROCAMS(S):</b> 4.8 x 3.6 mm, 6 mm diagonal (1/3 inch CCD) <b>PPROMCAMQ, PPROMCAMCQ, PPROCAMCQ &amp; PPROCAMCS(S):</b> 4.5 x 2.9 mm, 5.4 mm diagonal (1/3 inch CMOS) <b>PPROMCAM1.3Q, PPROCAM1.3Q &amp; PPROCAM1.3S(S):</b> 8.6 x 6.9 mm, 11 mm diagonal (2/3 inch CMOS)
Levels of Gray Scale or Color	<b>PPROMCAMQ, PPROCAMQ, PPROMCAM1.3Q, PPROCAM1.3Q, PPROCAMS(S) &amp; PPROCAM1.3S(S):</b> 256 Gray Scale <b>PPROMCAMCQ, PPROCAMCQ &amp; PPROCAMCS(S):</b> 256 Red, Green and Blue
Exposure Time	<b>PPROCAMQ &amp; PPROCAMS(S):</b> 0.10 to 2830 milliseconds <b>PPROMCAMQ, PPROMCAMCQ, PPROCAMCQ &amp; PPROCAMCS(S):</b> 0.10 to 1040 milliseconds <b>PPROMCAM1.3Q, PPROCAM1.3Q &amp; PPROCAM1.3S(S):</b> 0.10 to 1670 milliseconds
Full Image Acquisition*	<b>PPROMCAMQ, PPROCAMQ &amp; PPROCAMS(S):</b> 48 frames per second <b>PPROMCAMCQ:</b> 55 frames per second max. <b>PPROCAMCQ &amp; PPROCAMCS(S):</b> 17 frames per second max. <b>PPROMCAM1.3Q, PPROCAM1.3Q &amp; PPROCAM1.3S(S):</b> 18 frames per second max.
Interface	LVDS
Construction	<b>PPROMCAMQ, PPROCAMQ, PPROMCAM1.3Q, PPROCAM1.3Q, PPROMCAMCQ &amp; PPROCAMCQ:</b> black anodized aluminum and black painted die cast zinc <b>PPROCAMS, PPROCAM1.3S &amp; PPROCAMCS:</b> nickel-plated aluminum (Lens covers and ring lights are nickel-plated aluminum with glass or polycarbonate window) <b>PPROCAMSS, PPROCAM1.3SS &amp; PPROCAMCSS:</b> 316 stainless steel (Lens covers and ring lights are stainless steel with glass or polycarbonate window)
Environmental Rating	<b>PPROMCAMQ, PPROCAMQ, PPROMCAM1.3Q, PPROCAM1.3Q, PPROMCAMCQ &amp; PPROCAMCQ:</b> IEC IP20; NEMA 1 <b>PPROCAMS, PPROCAM1.3S &amp; PPROCAMCS:</b> IEC IP68; NEMA 6P <b>PPROCAMSS, PPROCAM1.3SS &amp; PPROCAMCSS:</b> IEC IP68; NEMA 6P and NEMA 4X
Outside Temperature	0 to +50 °C
Relative Humidity	<b>PPROMCAMQ, PPROCAMQ, PPROMCAM1.3Q, PPROCAM1.3Q, PPROMCAMCQ &amp; PPROCAMCQ:</b> 90% (non-condensing)
Certifications	

\* A reduced Field-of-View (FOV) dramatically increases acquisition rates.



SMBPPDH

Used with: Proll Controller



SMBPPDE

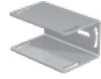

SMBPPLU



SMBPPRA



SMBPPU

Used with: Proll Cameras



SMBPPROMRA

Used with: Proll Mini Camera



SMBPPSU

Used with: Proll Camera



SMBP4RAB



SMBP4RAS

Used with: P4



SMBP4SRAF

Used with: Sealed P4

Additional bracket information is available  
See page 726

### Lens Covers



Length	Material	Works With	Model
50 mm	Nickel-plated aluminum	P4	P4SLC50-G
			P4SLC50-P
		Pro	PPSLC50-G
			PPSLC50-P
75 mm	Nickel-plated aluminum	Pro & P4	PPSLC75-G PPSLC75-P
50 mm	Stainless Steel	Pro	PPSSL50-G PPSSL50-P

### Adjustable Mounting System



- 3" and 6" column, base and knuckle kits for positioning of sensor and lights
- Bogen arm with clamp for added flexibility in mounting
- 2" pivoting knuckle assembly for positioning spot light

### Sensor Interface Modules and Power Supplies



- Sensor interface modules for simplified wiring of P4 sensors in an electrical box
- Lighting interface for strobe operation of Banner lighting with any vision sensor
- Strobe control module for control of specialty strobe lights

### Video Monitor



Description	Model*
8" Flat Panel NTSC	PPM8

\* Monitors require a BNC cordset for connection to a PresencePLUS Sensor (see page 356).

### Enclosures



- Offers models for sensors and lights
- Provides protection in rugged or harsh environments
- Prevents tampering

Accessories for C-Mount Lenses\*



Description	Format Size	Model	Used With
Extension Kit (0.5, 1.0 , 5.0, 10, 20 and 40 mm)	—	LEK	All Lenses
Extension Kit (0.25 and 0.5 mm)		LEKS	
Lens Extender (increases focal length 2X)		LCF2X	
UV Lens Filter, Clear Glass	2/3"	FLTUV	Tamron Megapixel Lenses

Bandpass Filters

Example Model Number: FLTB470-27

Description	Model	Diameter
Blue	FLTB470-	
Green	FLTG525-	25.5
Infrared	FLIB850-	27
Red	FLTR635-	30.5
Dark Red	FLTBR660-	34
Polarizing filter	FLTPR032-	43

Used with: iVu & PresencePLUS, VE

C-Mount Color Filters\*



Color	Description	Plastic Models	Glass Models
Infrared	High-pass filter blocks visible light and passes infrared light. Included with all Banner Infrared light sources.	FLTI ( > 760 nm)	FLTI850 (810-990 nm)
Blue	Band-pass filter improves quality by helping to reduce ambient light; it passes blue and infrared light.	FLTB (400-525 nm)	FLTB470 (435-490 nm)
Green	Band-pass filter improves quality by helping to reduce ambient light; it passes green and infrared light.	FLTG (400-575 nm)	FLTG525 (495-565 nm)
Red	High-pass filter improves quality by helping to reduce ambient light; it passes red and infrared light.	FLTR ( > 600 nm)	FLTR635 (600-660 nm)
Dark Red	High-pass filter improves quality by helping to reduce ambient light; it passes red and infrared light.	—	FLTR660 (650-680 nm)

C-Mount Standard Lenses

Description	Format Size	Model	Used With	
	4 mm	LCF04	Camera resolutions < 1 MP	
	8 mm	LCF08		
	12 mm with Focus Locking	LCF12		
	16 mm with Focus Locking	LCF16		
	25 mm with Focus Locking (Goyo)	1"		LCF25R*
	25 mm with Focus and Aperture Locking, Metal Housing (Goyo)	1"		LCF25LR**
	50 mm with Focus and Aperture Locking (Goyo)	2/3"		LCF50L1R**
	50 mm with Focus Locking, Metal Housing (Goyo)	1"		LCF50L2R*
75 mm with Focus and Aperture Locking, Metal Housing (Goyo )	1"	LCF75LR*		

C-Mount Specialty Lenses

Description	Format Size	Model	Used With
	3.5 mm with Focus and Aperture Locking (Kowa)	LCF03LT**	Camera resolutions < 1 MP
	6 mm with Focus and Aperture Locking (Kowa)	LCF06LK**	
	10 – 40 mm with Zoom, and Focus and Aperture Locking (Tamron)	LCF1040LT*	
	50 mm Telecentric (Navitar)	LCF50TELN*	

C-Mount Megapixel Lenses with Focus and Aperture Locking

Description	Format Size	Model	Filter Diameter (mm)	Used With	
	8 mm (Tamron)	LCF08LTMP**	25.5	Camera resolutions > 1 MP	
	16 mm (Tamron)	LCF16LTMP**			
	25 mm (Tamron)	LCF25LTMP**			
	50 mm (Tamron)	LCF50LTMP†			
	16 mm (Ricoh)	LCF16LMP**	27.3		
	25 mm (Ricoh)	LCF25LMP**			
	35 mm (Ricoh)	LCF35LMP**			
	50 mm (Ricoh)	LCF50LMP**			
	5 mm (Computar)	1/2"	LCF05LCMP*		43
	8 mm (Computar)		LCF08LMP**		
	12 mm (Computar)		LCF12LMP**		
	16 mm (Computar)		LCF16LCMP**		
	25 mm (Computar)	2/3"	LCF25LCMP**		
	35 mm (Computar)		LCF35LCMP†		
	50 mm (Computar)		LCF50LCMP†		
	75 mm (Computar)		LCF75LCMP†		
	6 mm (Evetar)	1/1.8"	LCF06LEVMP		34
	8.5 mm (Evetar)	1/1.8"	LCF08LEVMP		27
	12 mm (Evetar)	2/3"	LCF12LEVMP		27
	16 mm (Evetar)	2/3"	LCF16LEVMP		27
25 mm (Evetar)	2/3"	LCF25LEVMP	27		
35 mm (Evetar)	2/3"	LCF35LEVMP	27		
50 mm (Evetar)	2/3"	LCF50LEVMP	30.5		
75 mm (Evetar)	1"	LCF75LEVMP	34		

\* Lens will not fit in High Intensity Banner Ring Lights with aperture and/or focal ring thumb screws installed (example, LEDRR70XD5-XM)

\*\* Lens will not fit inside any ring light or sealed camera lens cover as the lens body diameter is too large

† Lenses require a 75 mm cover when used with a Sealed Pro or P4 Camera (see page 361)



## Vision Lighting

Vision lighting is the key to creating all-important contrast between the feature of interest and its background.





**Ring Lights**

Mounts directly to the sensor for easy setup and illuminates any object directly in front of the sensor  
page 366



**Area Lights**

Provides even illumination in a concentrated area  
page 378



**Backlights**

Installs behind the target, directly facing the sensor; has a highly diffused surface and uniform brightness  
page 370



**Linear Array Backlights**

Diffused backlights that can be used for any vision system or as a highly diffused area light  
page 371

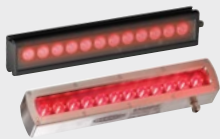

**Linear Array Lights**

Provides high-intensity illumination of large areas, at long distances  
page 372



**On-Axis Lights**

Provides collimated illumination along the same optical path as the camera  
page 373

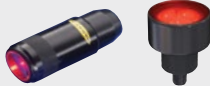

**Spot Lights**

Provides even illumination in a small concentrated spot  
page 374

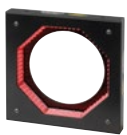

**Low-Angle Ring Lights**

Illuminates nearly perpendicular to the direction of an inspection  
page 376



**Laser Line Generator**

Laser Line Generators have dynamic line balancing for repeatable performance  
page 377



# Ring Lights

## LED Vision Lights

- Connects directly to *PresencePLUS* or VE vision sensors or an external power supply
- Brightly illuminates small objects
- Mounts directly to the camera and centers the light on the image
- Includes models to withstand washdown environments (IP68 rated)
- Cordsets and brackets see page 378

### IP50 High-Intensity

Example Model Number: LEDRR70XD5-XM

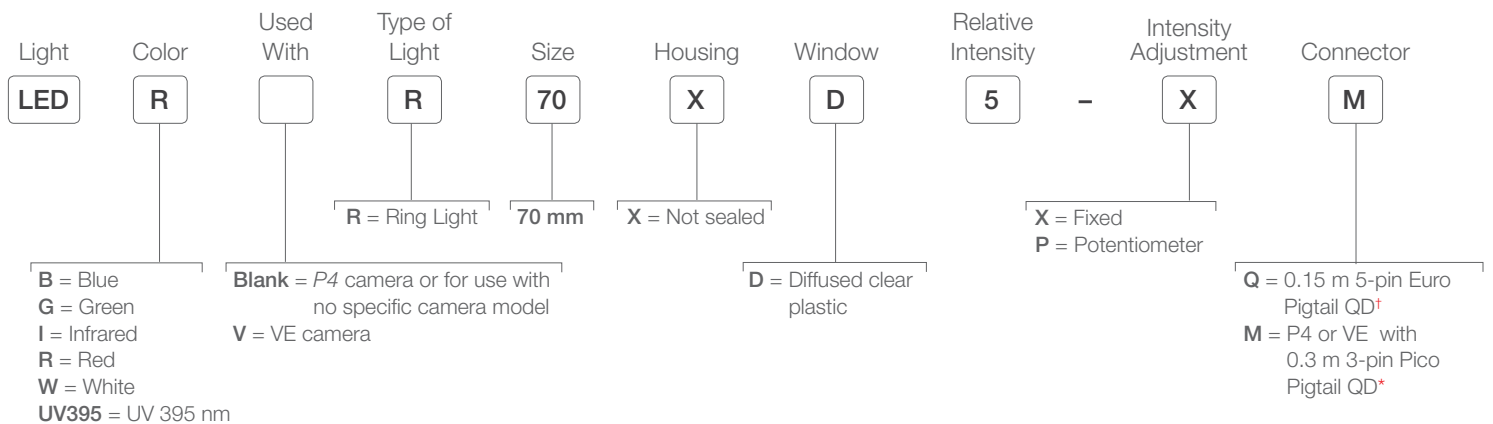

**Connection options:**

\* Pico QD model required for P4 or VE sensors.  
 Pico QD models include a built-in mounting bracket for use with P4 or VE sensors.  
<sup>†</sup> Models require a mating cordset (see page 378).  
 Optional bracket SMBPPRHI required for use with Pro cameras (see page 378).  
 Optional bracket SMBPMPRHI required for use with Pro Mini cameras (see page 378).



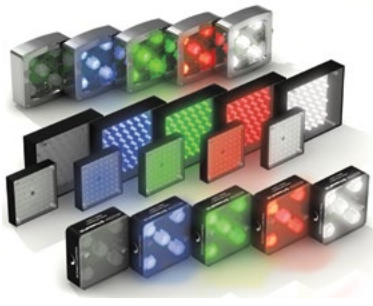

# Area Lights

## LED Vision Lights

- Provides even illumination in a concentrated area
- Creates shadows or glare to detect changes in depth, depending on mounting
- High-intensity lighting for distances greater than 12 inches
- Cordsets and brackets see page 378

### IP50 High-Intensity Area Light

Example Model Number: LEDRA70XD5-XM

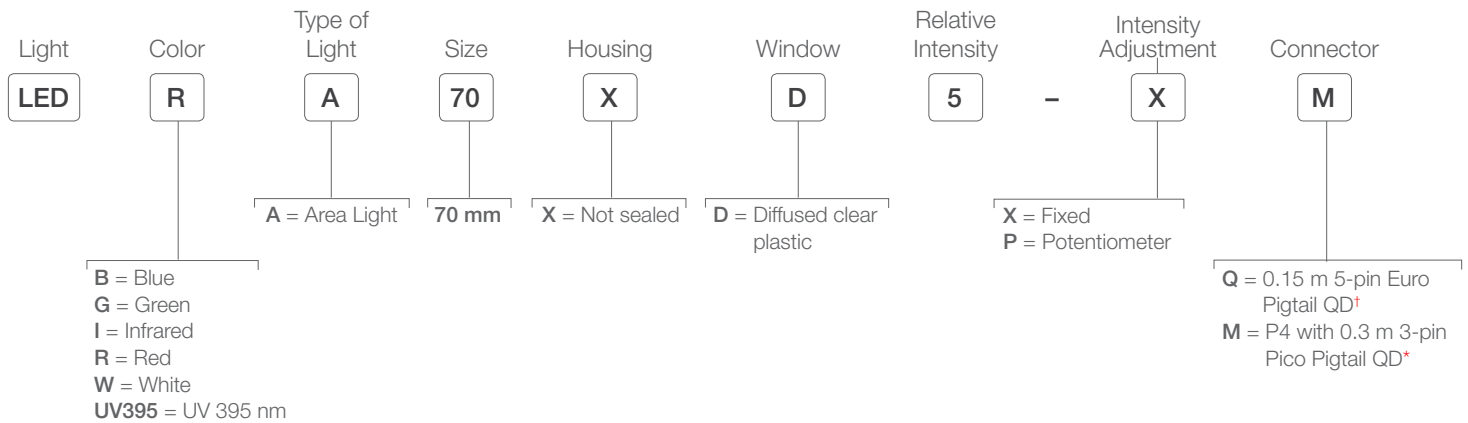

**Connection options:**

- \* Pico QD model required for P4 or VE sensors.
- † Models require a mating cordset (see page 378).
- †† For replacement windows and diffusers (see page 379).

IP68 Sealed High-Intensity Area Light

Example Model Number: LEDRA70AD5-XQ

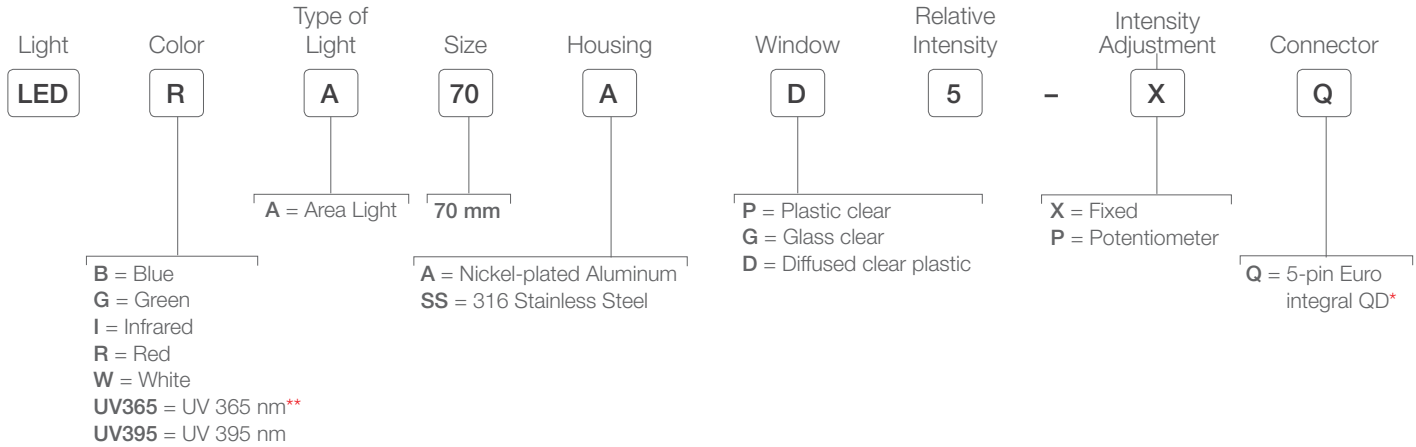

IP40 LED Area Light

Example Model Number LEDRA80X80W

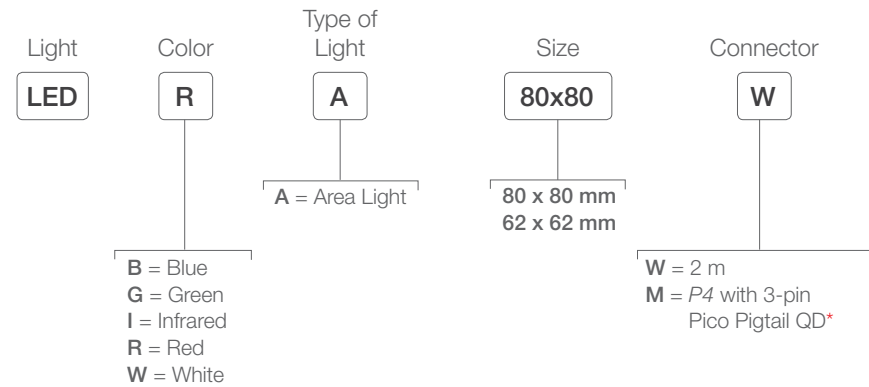

Connection options:

For 9 m cable, add suffix W/30 to the 2 m model number (example, LEDRA80X80W W/30).  
 QD models can be connected directly to P4 sensors; splitter cordset available for powering two lights (see page 378).  
 \* Models require a mating cordset (see page 378)  
 \*\* UV365 can only be used with glass window  
 † For replacement windows and diffusers (see page 378)

# Back Lights

## LED Vision Lights

- Determines the shape and size of target objects
- Offers a highly diffused surface and uniform brightness, with lower intensity than other lights
- Provides the most robust lighting for measuring and gauging
- Highlights through-holes in target objects
- Cordsets and brackets see page 378



### IP67 Sealed LED Backlights

Example Model Number LEDRB75X150PW2-XQ

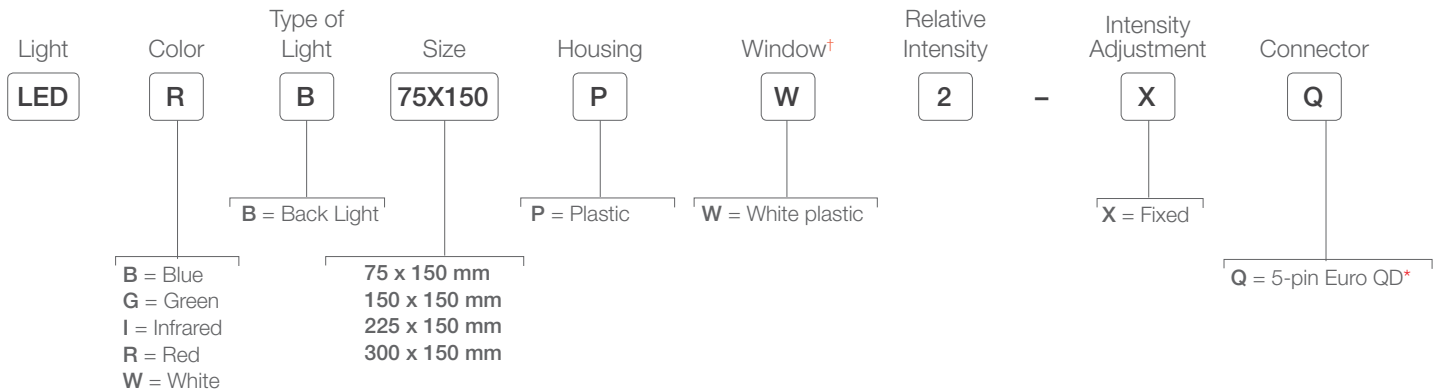

### IP40 LED Backlights

Example Model Number LEDRB70X70Q

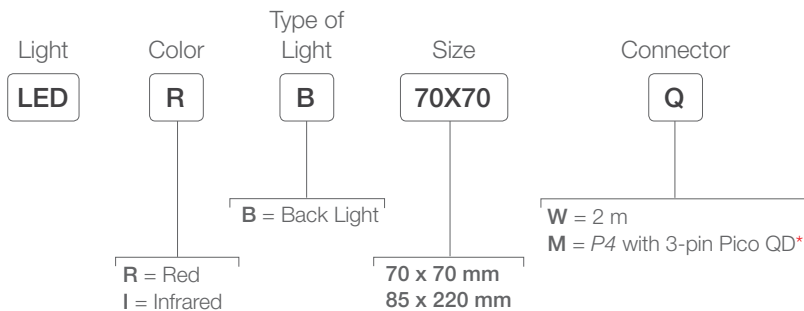

Connection options: A model with a QD requires a mating cordset (see page 378).

For 9 m cable, add suffix W/30 to the 2 m model number (example, LEDRB70X70W W/30).

QD models can be connected directly to P4 sensors; splitter cordsets available for powering two lights (see page 378).

\* Models require a mating cordset (see page 378).

† For replacement windows and diffusers (see page 379).

# Linear Array Backlights

## LED Vision Lights



- Built-in constant current regulation with very even light pattern
- Optically isolated strobe signal with selectable Active High or Active Low strobe option
- Maintenance-free, rugged construction
- Four high-intensity, visible wavelengths, plus IR
- Cordsets and brackets see page 378

### IP50 High Power LED Linear Array Backlights

Example Model Number LEDRLB145XW6-XQ

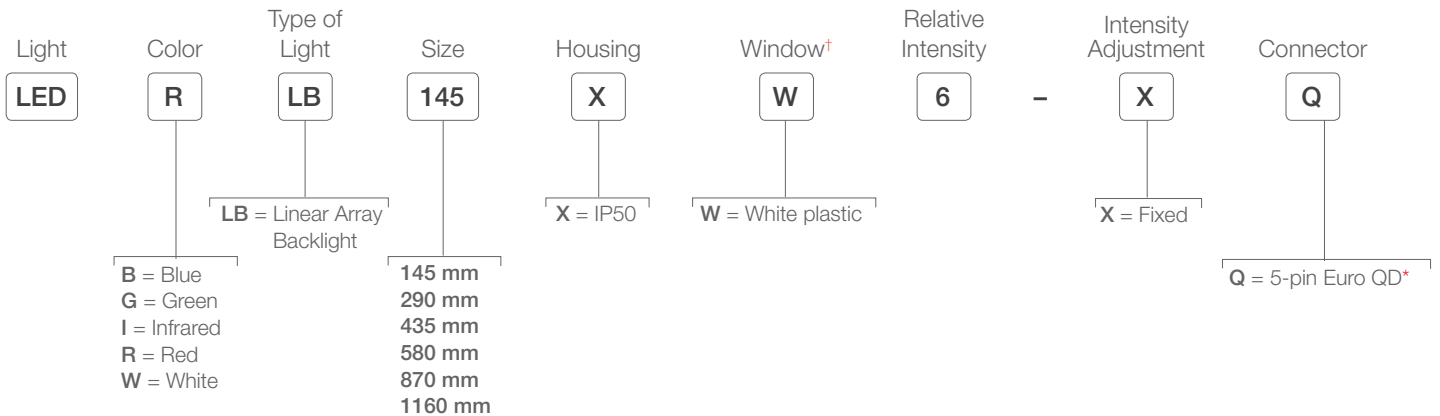

Connection options: A model with a QD requires a mating cordset (see page 378).

\* Models require a mating cordset (see page 378).

† For replacement windows and diffusers (see page 379).



# Linear Array Lights

## LED Vision Lights



- Provides maintenance-free LED illumination of large objects from far away
- Provides superior high-intensity illumination of large areas
- Available in sealed (IP68) nickel-plated and non-sealed (IP50) housings
- Provides optically isolated strobe signal
- Cordsets and brackets see page 378

### IP50 High-Intensity LED Linear Array

Example Model Number: LEDRA70XD5-XM

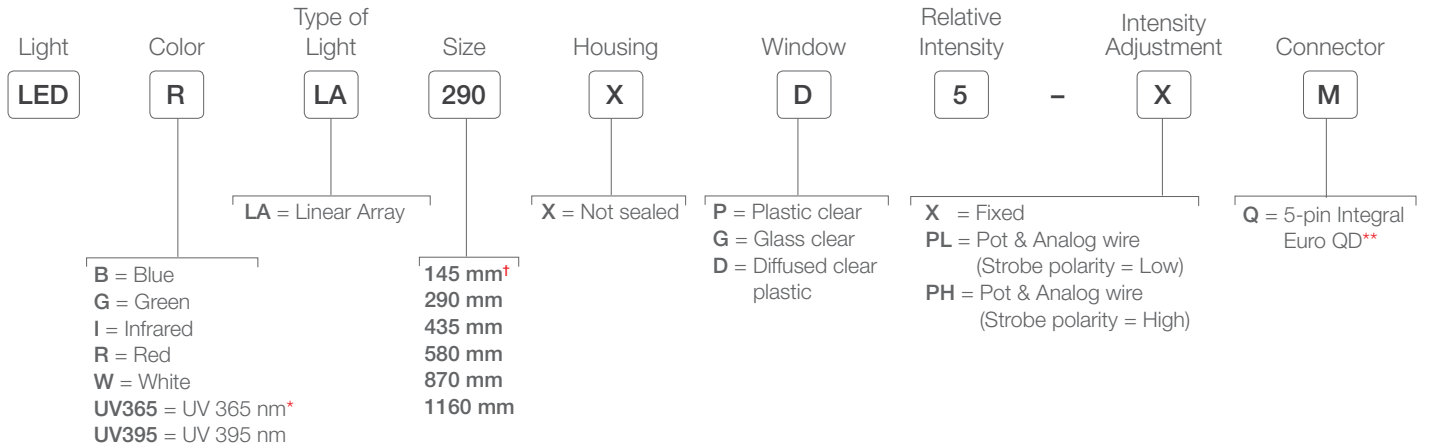

### IP68 High-Intensity LED Linear Array

Example Model Number: LEDRA70XD5-XM

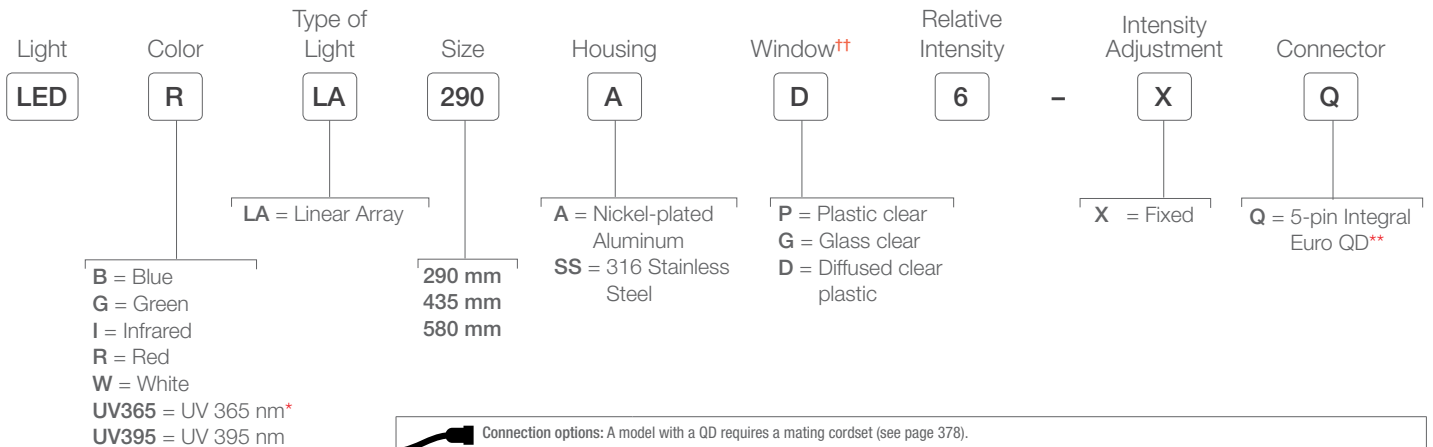

 Connection options: A model with a QD requires a mating cordset (see page 378).

\* UV365 can only be used with glass window  
 \*\* Models require a mating cordset (see page 378).  
 † Intensity adjustment not available on 145 mm length  
 †† For replacement windows and diffusers (see page 379).

# On-Axis Lights

## LED Vision Lights



- Provides more uniform illumination than a ring light
- Delivers collimated illumination in the same optical path as camera
- Evenly illuminates flat reflective surfaces
- Provides minimum useful life of 10,000 to 60,000 hours, depending on model
- Cordsets and brackets see page 378

### IP40 LED On-Axis Light

Example Model Number LEDRA100W

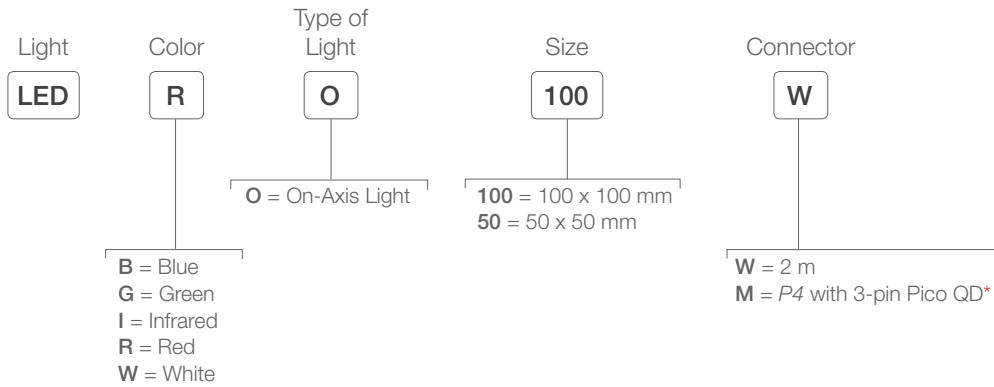

Connection options: A model with a QD requires a mating cordset (see page 378).

QD cordsets with flying leads are available for connecting to models other than P4 (see page 378).

\* Models require a mating cordset (see page 378).

# Spot Lights

## LED Vision Lights

- Low-cost, compact washdown spot lights for PresencePLUS® sensors
- Continuous or strobed operation is selectable via sensor software
- Provides extremely bright, even light with high-power LEDs
- Adjustable spot size
- Direct connection to *PresencePLUS® Pro* sensor or to an external power supply using 3 discrete wires
- Cordsets and brackets see page 378



### IP68 Sealed LED Spot Light

Example Model Number LEDRSW

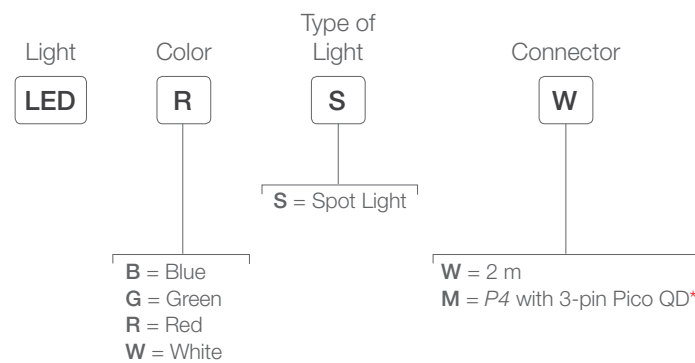

 Connection options: A model with a QD requires a mating cordset (see page 378).

For 9 m cable, add suffix W/30 to the 2 m model number (example, LEDRSW W/30).

QD models can be connected directly to P4 sensors; splitter cordsets available for powering two lights (see page 378).

\* Models require a mating cordset (see page 378).

# High-Intensity Spot Lights

## LED Vision Lights



- Provides more uniform illumination than a ring light
- Delivers collimated illumination in the same optical path as camera
- Evenly illuminates flat reflective surfaces
- Provides minimum useful life of 10,000 to 60,000 hours, depending on model
- Cordsets and brackets see page 378

### IP69K Sealed High Intensity LED Spot Lights

Lens Angle	Color	Lumens	Lux		Connection	Models
			0.5 m	1 m		
± 5° (smaller, more focused spot)	Red	110	8,000	2,000	5-pin Euro integral QD connector (use with a 5-wire mating cordset)	LEDRS50L5-XQ
	White	295	13,780	3,445		LEDWS50L5-XQ
	Blue	85	4,880	1,220		LEDBS50L5-XQ
	Green	210	13,000	3,250		LEDGS50L5-XQ
	IR	760*	4.40**	1.10**		LEDIS50L5-XQ
	UV	480*	2.10**	0.52**		LEDUV395S50L5-XQ
± 11° (larger spot)	Red	105	2,500	625	5-pin Euro integral QD connector (use with a 5-wire mating cordset)	LEDRS50L11-XQ
	White	285	5,460	1,365		LEDWS50L11-XQ
	Blue	80	1,540	385		LEDBS50L11-XQ
	Green	200	3,900	975		LEDGS50L11-XQ
	UV	420*	0.78**	0.19**		LEDUV395S50L11-XQ
± 14° (larger spot)	IR	665*	1.16**	0.29**	5-pin Euro integral QD connector (use with a 5-wire mating cordset)	LEDIS50L14-XQ
± 20° (largest spot)	Red	100	1,040	260	5-pin Euro integral QD connector (use with a 5-wire mating cordset)	LEDRS50L20-XQ
	White	270	2,000	500		LEDWS50L20-XQ
	Blue	75	700	175		LEDBS50L20-XQ
	Green	190	1,700	425		LEDGS50L20-XQ
	UV	390*	0.42**	0.10**		LEDUV395S50L20-XQ

 Connection options: A model with a QD requires a mating cordset (see page 378).

For 2 m cable, omit suffix XQ from model number (example, LEDRS50L5).

\* Values listed in milliwatts

\*\* Values listed in mW/cm<sup>2</sup>

# Low Angle Ring Lights

## LED Vision Lights



- Highlights surface irregularities
- Highlights slight height differences such as etching, solder balls and embossing
- Illuminates from an angle nearly perpendicular to object
- Provides minimum useful life of 10,000 to 60,000 hours, depending on model
- Cordsets and brackets see page 378

### LED Low Angle Ring Lights

Example Model Number LEDR11503M

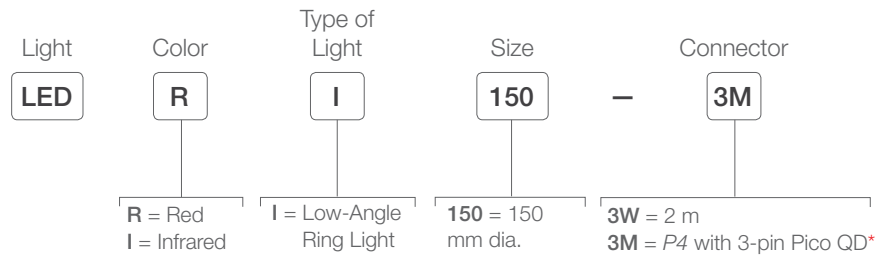

# Laser Line Generator



- Laser line uniformity up to 95% on 100% of the line
- External user focus mechanism
- Robust thermal management, providing better stability and longer lifetime
- Remote laser monitoring and control via RS232 communication
- Brackets see page 378

## Laser Line Generator, 5-24 V DC

 Visible Red Laser

Description	Models
Laser Line Generator: 660 nm; 10mW, 60 degree fan angle Class II CDRH, RS232 Communication Flying leads	<b>LLG660P10A60II</b>
Laser Line Generator: 660 nm; 50mW, 60 degree fan angle Class IIIA CDRH Flying leads	<b>LLG660P50A60III</b>
Laser Line Power Supply Generator: 660 nm, 10 mW 60 degree fan angle, Class II CDRH Flying leads	<b>PSLLG12V</b>

 Connection options: A model with a QD requires a mating cordset (see page 378).  
 QD cordsets with flying leads are available for connecting to models other than P4 (see page 378).  
 \* Models require a mating cordset (see page 378).



**M12/Euro-Style**  
Straight connector models listed; for right-angle, add **RA** to the end of the model number (example, **MQDC20-506RA**)

**Nickel-Plated Nut**  
**MQDC20-506**  
2 m (6.5')  
**MQDC20-515**  
5 m (15')  
**MQDC20-530**  
9 m (30')

**Stainless Steel Nut**  
**MQDC20SS-506**  
2 m (6.5')  
**MQDC20SS-515**  
5 m (15')  
**MQDC20SS-506**  
9 m (30')



**3-Pin Pico-Style**  
Straight connector models listed

**Nickel-Plated Nut**  
—  
**PKG3M-5**  
5 m (16')  
**PKG3M-7**  
7 m (23')  
**PKG3M-10**  
10 m (33')

**Stainless Steel Nut**  
**PKG3M-4**  
4 m (13')  
—  
**PKG3M-7**  
7 m (23')  
**PKG3M-10**  
10 m (33')



**Euro-Style**  
Straight connector models listed; for right-angle, add **RA** to the end of the model number (example, **MQDC1-506RA**)

**MQDC1-506**  
2 m (6.5')  
**MQDC1-515**  
5 m (15')  
**MQDC1-530**  
9 m (30')



**Pico-Style Splitter**  
Straight connector models listed

**CSB-M831M831†**  
Branches = 0.20 m (0.65 ft)  
Trunk = 0.20 m (0.65 ft)

**Pico-Style Splitter**  
Straight connector models listed. One 3-pin Pico QD and one 4-Pin Euro QD.



**CSB-UNT213M831F1241††**  
Branches = 0.3 m (1ft)  
Trunk = Flying leads

† Powers 2 lights from one P4 sensor

†† Enables strobe signal from P4 while obtaining power from an external source



**Pico-Style Double-Ended**  
Straight connector models listed

**PKG3M-.35-PSG3M**  
0.35 m (1 ft)  
**PKG3M-2-PSG3M**  
2 m (6.5 ft)

Additional cordset information is available. See page 758



SMBBSSM



SMBACM



SMBP42ASM

Used with: Area Lights & Backlights



SMBLASRA

Used with: Linear Array



SMBPMPRHI

Used with: Ring Lights



SMBP40AL..



SMBPPOAL..

Used with: On-Axis

Additional bracket information is available. See page 726

Polarizing Filters

Description	Models
Linear Polarizing filter kit for 62 x 62 Ring Lights	LEDRPFKS
Linear Polarizing filter kit for 80 x 80 Area Lights and 70 x 70 Backlights	LEDAPFK
Linear Polarizing filter kit for 62 x 62 Area Lights	LEDAPFKS
Linear Polarizing filter kit for Sealed Ring Lights	LEDRPFK90
Linear Kit with a variety of filters, diffusers and window replacements	LEDFLT
Linear Polarizing filter kit for 290 mm Linear Array Lights (IP68)	LEDLAPFK290S
Linear Polarizing filter kit for 580 mm Linear Array Lights (IP68)	LEDLAPFK580S
Linear Polarizing filter kit for 145 mm Linear Array Lights (IP50)	LEDLAPFK145

Polarizing Filters

Description	Models
Linear Polarizing filter kit for 290 mm Linear Array Lights (IP50)	LEDLAPFK290
Linear Polarizing filter kit for 435 mm Linear Array Lights (IP50)	LEDLAPFK435
Linear Polarizing filter kit for 580 mm Linear Array Lights (IP50)	LEDLAPFK580
Linear Polarizing filter kit for 870 mm Linear Array Lights (IP50)	LEDLAPFK870
Linear Polarizing filter kit for 1160 mm Linear Array Lights (IP50)	LEDLAPFK1160
Linear Polarizing filter kit for 70 mm High-Intensity Area Lights	LEDAPFK70
Linear Polarizing filter kit for 70 mm High-Intensity Ring Lights	LEDRPFK70
Linear Polarizing filter kit for 70 mm IP68 High-Intensity Area Lights	LEDAPFK70S
Linear Polarizing filter kit for 50mm High-Intensity Spot Lights	LEDS0PFK



Window Replacements and Lighting Diffusers

Use With	Models
<b>Clear Plastic</b>	
62 x 62 mm Ring Lights	LEDRCWS
80 x 80 mm Ring Lights	LEDRCW
62 x 62 mm Area Lights	LEDAWS
80 x 80 mm Area Lights	LEDAW
70 mm Sealed High-Intensity Area Lights	LEDA70SW-P
145 mm IP50 Linear Array Lights	LEDLA145XW-P
290 mm IP50 Linear Array Lights	LEDLA290XW-P
290 mm Sealed IP68 Linear Array Lights	LEDLA290SW-P
435 mm IP50 Linear Array Lights	LEDLA435XW-P
435 mm Sealed IP68 Linear Array Lights	LEDLA435SW-P
580 mm IP50 Linear Array Lights	LEDLA580XW-P
580 mm Sealed IP68 Linear Array Lights	LEDLA580SW-P
870 mm Sealed IP50 Linear Array Lights	LEDLA870XW-P
1160 mm IP50 Linear Array Lights	LEDLA1160XW-P
<b>Clear Plastic Diffuse</b>	
80 x 80 mm Ring Lights	LEDRCDW
62 x 62 mm Right Lights	LEDRCDWS
70 mm High-Intensity Ring Lights	LEDR70CDW
70 mm High-Intensity Area Lights	LEDA70CDW
70 mm Sealed IP68 High-Intensity Area Lights	LEDA70SCDW-P
145 mm IP50 Linear Array Lights	LEDLA145XCDW-P
290 mm IP50 Linear Array Lights	LEDLA290XCDW-P
290 mm Sealed IP68 Linear Array Lights	LEDLA290SCDW-P
435 mm IP50 Linear Array Lights	LEDLA435XCDW-P
435 mm Sealed IP68 Linear Array Lights	LEDLA435SCDW-P
580 mm IP50 Linear Array Lights	LEDLA580XCDW-P
580 mm Sealed IP68 Linear Array Lights	LEDLA580SCDW-P
870 mm IP50 Linear Array Lights	LEDLA870XCDW-P
1160 mm IP50 Linear Array Lights	LEDLA1160XCDW-P
<b>Clear Glass</b>	
70 mm Sealed IP68 High-Intensity Area Lights	LEDA70SW-G
145 mm IP50 Linear Array Lights	LEDLA145XW-G
290 mm IP50 Linear Array Lights	LEDLA290XW-G
290 mm Sealed IP68 Linear Array Lights	LEDLA290SW-G
435 mm IP50 Linear Array Lights	LEDLA435XW-G
435 mm Sealed IP68 Linear Array Lights	LEDLA435SW-G
580 mm IP50 Linear Array Lights	LEDLA580XW-G
580 mm Sealed IP68 Linear Array Lights	LEDLA580SW-G
870 mm IP50 Linear Array Lights	LEDLA870XW-G
1160 mm IP50 Linear Array Lights	LEDLA1160XW-G

Use With	Models
<b>White Plastic</b>	
70 x 70 mm Red Backlights	LEDBW
70 x 70 mm Infrared Backlights	LEDBIW
85 x 220 mm Red Backlights	LEDBWL
85 x 220 mm Infrared Backlights	LEDBIWL
<b>White Plastic Diffuse</b>	
62 x 62 mm Ring Lights	LEDRDWS
80 x 80 mm Ring Lights	LEDRDW
62 x 62 mm Area Lights	LEDADWS
80 x 80 mm Area Lights	LEDADW
70 mm Sealed High-Intensity Area Lights	LEDA70SWDW-P
145 mm IP50 Linear Array Lights	LEDLA145XWDW-P
290 mm IP50 Linear Array Lights	LEDLA290XWDW-P
290 mm Sealed IP68 Linear Array Lights	LEDLA290SWDW-P
435 mm IP50 Linear Array Lights	LEDLA435XWDW-P
435 mm Sealed IP68 Linear Array Lights	LEDLA435SWDW-P
580 mm IP50 Linear Array Lights	LEDLA580XWDW-P
580 mm Sealed IP68 Linear Array Lights	LEDLA580SWDW-P
870 mm IP50 Linear Array Lights	LEDLA870XWDW-P
1160 mm IP50 Linear Array Lights	LEDLA1160XWDW-P



## Lighting & Indicators

Banner offers a wide variety of lighting and indicator solutions, including LED lighting, signal tower lights, indicators, touch buttons and pick-to-light indicators. With flexible designs, high-quality and energy-efficient LED products, Banner's lighting and indication selection offers a unique solution that suits many environmental, workplace efficiency and mounting needs.

# LIGHTING & INDICATORS

---

LED LIGHTING **page 384**

SIGNAL TOWER LIGHTS **page 412**

INDICATORS **page 434**

TOUCH BUTTONS **page 468**

PICK-TO-LIGHT **page 482**

# Light Up the Visual Factory

Enhance your Visual Management Efforts with Banner's Lighting and Indicators.



## Illuminate the Work Area with LED Lighting

- Boost Worker Productivity
- Improve Product Quality
- Reduce Energy Costs

Electrical Panel Lighting

Machine Lighting

Workstation Lighting

Visual Inspection Station

Sensor Emulation

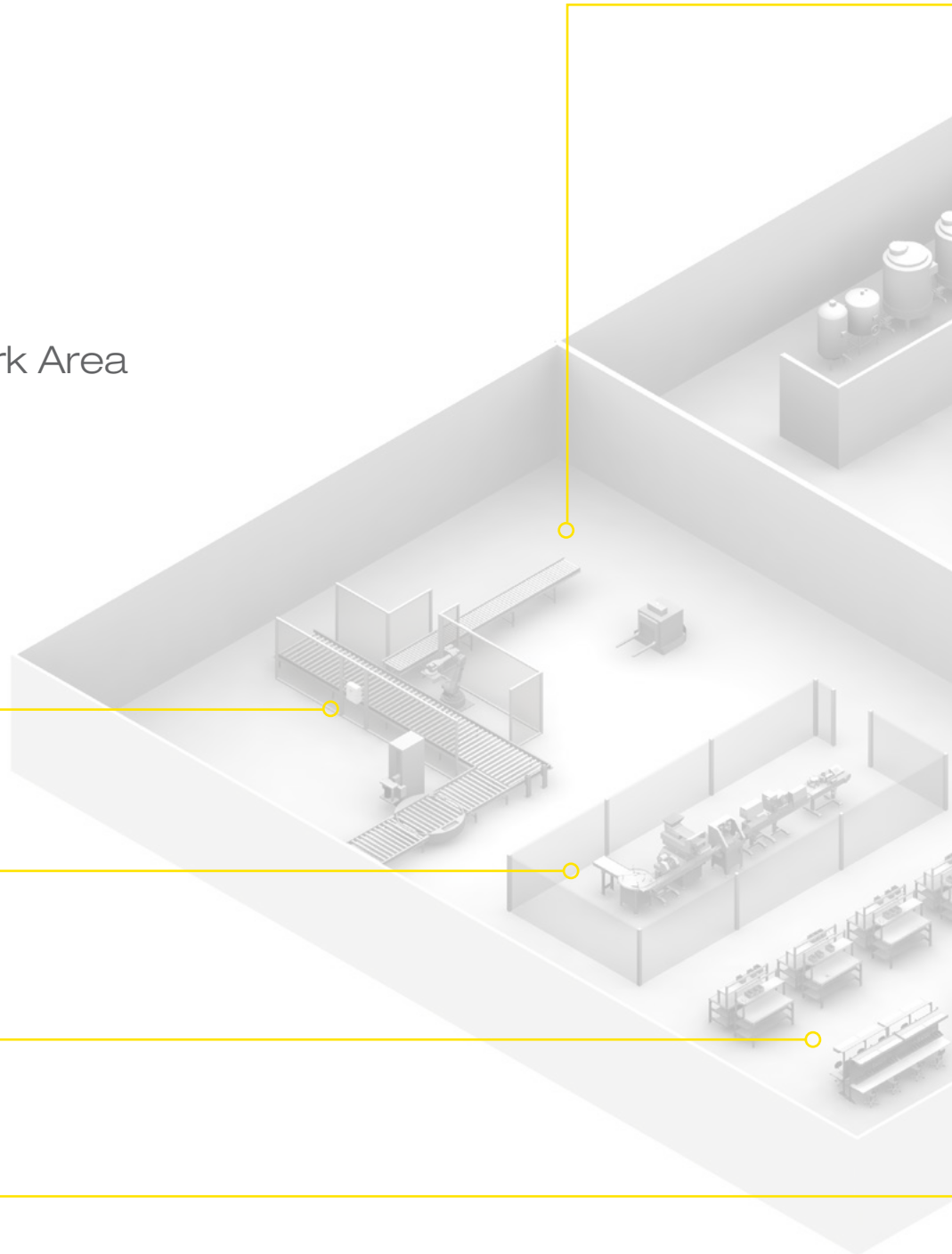

# Communicate Status

- Empower Operators
- Alert Supervisors
- Accelerate Resolution



Machine and Process Status

Call for Parts

Loading Dock/Bay Communication

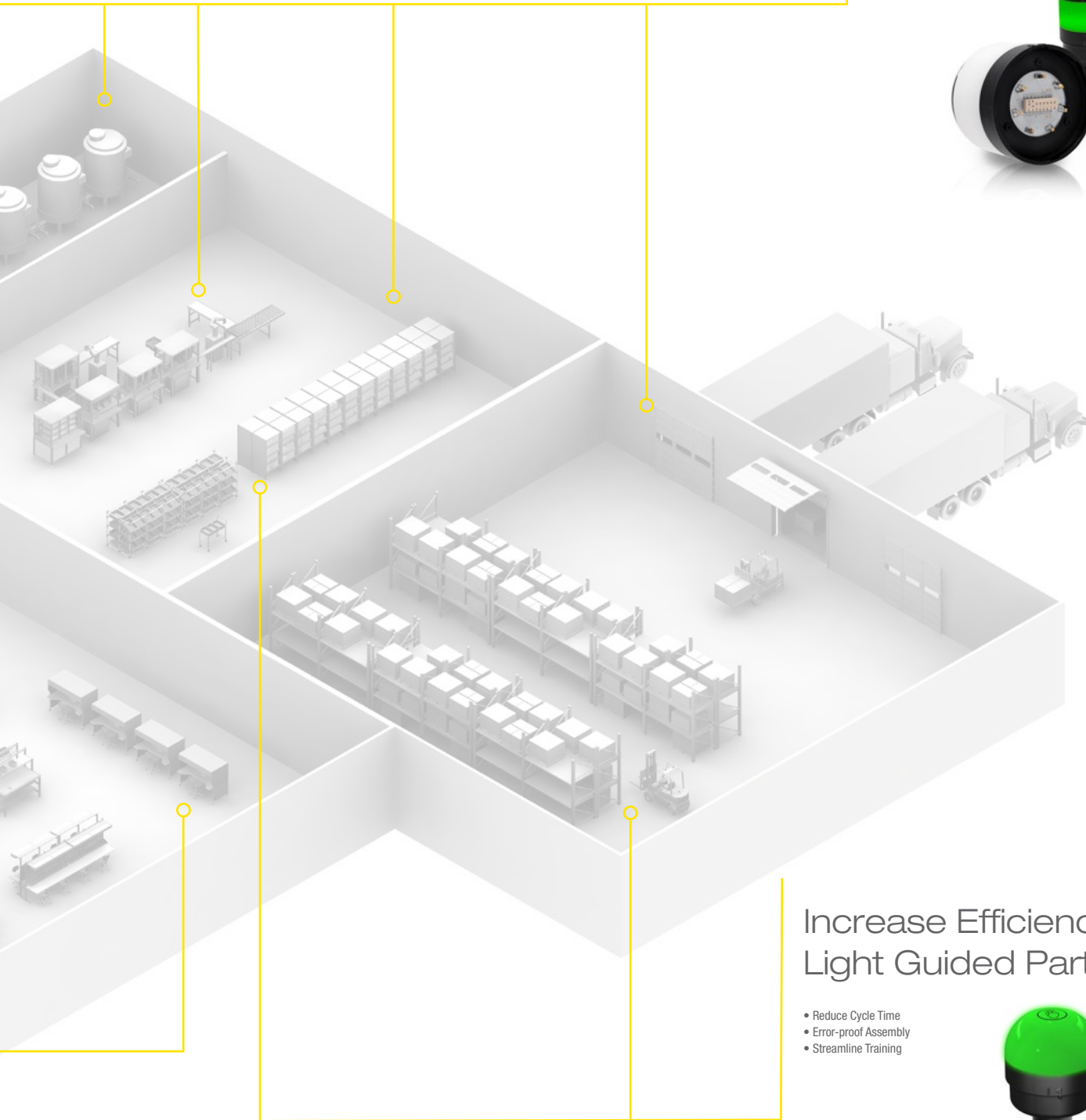

Pick-to-Light for Assembly and Kitting

Pick-to-Light for Warehouse and Logistics

# Increase Efficiency with Light Guided Part Picking









- Reduce Cycle Time
- Error-proof Assembly
- Streamline Training





## LED Lighting

Banner's LED lighting offers high-quality, energy-efficient products that provide bright illumination for up to 50,000 hours. Robust, vibration-resistant housings and sleek designs make Banner's LED lighting ideal for a wide range of industrial and mobile applications, including machine lighting, enclosure lighting, visual inspection illumination and work cell lighting.

Series	Description	Available Colors	Dimensions (L x W x D)	Housing Material	Power Supply
	<b>WLS28-2</b> Banner's LED Strip Light has a sturdy aluminum housing, shatterproof window and a low-profile, space-saving design. page 386	Cool White Warm White Red Green Blue Yellow UV365 UV395	Length varies by model <b>Unlensed:</b> 21 x 28 mm <b>Lensed:</b> 32.2 x 28 mm	Clear anodized aluminum	12 to 30 V dc
	<b>WLS15</b> Banner's LED Strip Light has a low-profile, space-saving design and is perfect for cabinet lighting. page 390	Daylight White Cool White	Length varies by model 30.6 x 15.5 mm	Clear anodized aluminum inner housing	12 V dc or 24 V dc
	<b>WLB32</b> Banner's WLB32 is a bright LED fixture that features an even light output for a no glare 'glow.' page 392	Daylight White	Length varies by model 32 x 46 mm	Anodized aluminum	12 to 30 V dc, 90 to 264 V ac
	<b>WLB92</b> Banner's WLB92 is an ultra-bright LED fixture that features an even light output. page 394	Daylight White Warm White Red Green Blue Yellow	Length varies by model 97.4 x 103.6 mm	Anodized aluminum	24 V dc, 100 to 277 V ac
	<b>WLS27</b> Protected by a shatterproof copolyester shell and a redundant sealing method prevents water ingress. Each strip light provides brilliant, even illumination. page 396	Cool White Warm White Red Green Blue Yellow UV395	Lighted length varies by model ø 27 mm	FDA-grade copolyester outer housing	12 to 30 V dc
	<b>WLC60</b> The WLC60 Heavy-Duty LED Light is engineered to withstand harsh environments making it the first choice for a machine lighting solution. page 398	Cool White	<b>Base mount:</b> (339 or 638) x 60.9 x 31.3 mm  <b>Flush mount:</b> 367 x 88 x 30.8 mm	Nickel-plated aluminum or 316 Stainless Steel	12 to 30 V dc
	<b>WLC90</b> Extremely compact and bright, making them an excellent choice for machining centers and food processing equipment. page 400	Cool White	89.0 x 91.0 x 28.2 mm	Nickel-plated aluminum	12 to 30 V dc
	<b>WLA</b> Area Lights provide high intensity, uniform light with low energy consumption and a small footprint. page 402	Cool White Warm White Red Green Blue Yellow	Length varies by model 25.8 x 180.1 mm	PBT	12 to 30 V dc
	<b>WL50S</b> These lights are rugged and water-resistant, making them a good choice for machine lighting, food and beverage applications and mobile applications. page 404	Cool White, Green, Red	<b>WL50S:</b> 65.8 x ø 50 mm <b>WL50S (stainless):</b> 71 x ø 56 mm	<b>WL50S:</b> Black anodized aluminum  <b>SS models:</b> Stainless Steel	12 to 30 V dc



# WLS28-2 Series

## LED Strip Lights



- Sturdy aluminum housings, shatterproof windows and a low-profile, space-saving design
- Enhanced light quality with bright, densely-spaced LEDs (8 color options available)
- Rugged, water-resistant IP69K models
- Magnetic mount options available for easy installation
- Can be cascaded end-to-end to minimize wiring
- Dimmable models available see page 408

### Dual-Color WLS28-2

Example Model Number: WLS28-2XWR2-285DXPBQ

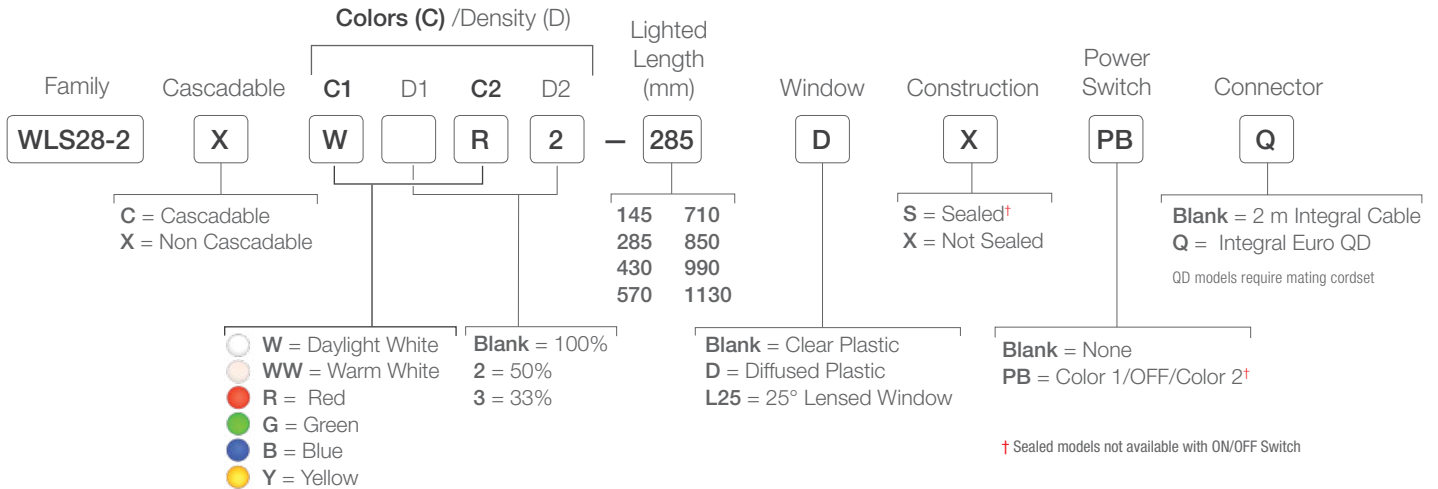

### 1 -Color WLS28-2

Example Model Number: WLS28-2CW145DXPBQ

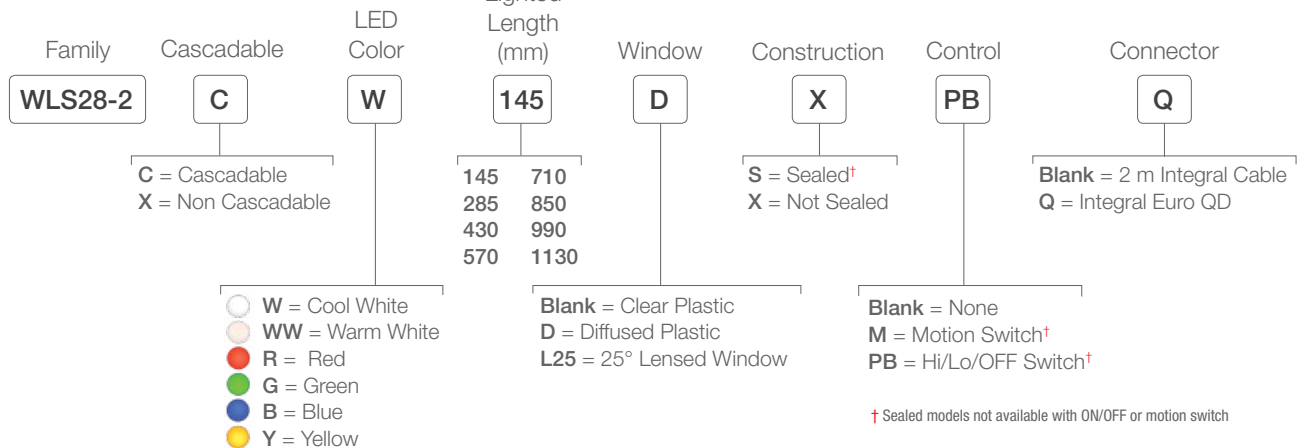

For more specifications see page 389.

Connection options: A model with a QD requires a mating cordset

UV WLS28-2

Example Model Number: WLS28-2CUV395-285XPBQ

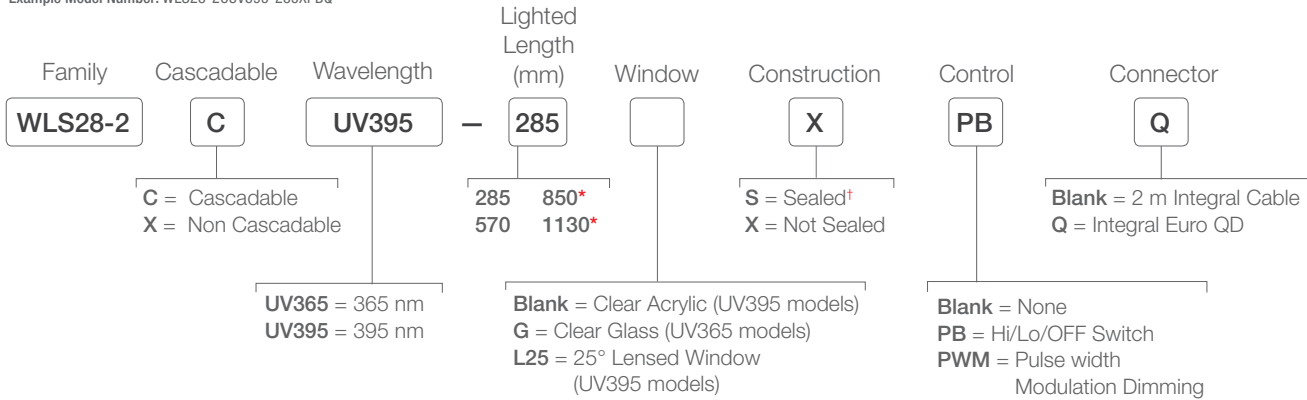

\* Not available in UV365 models  
† Sealed models not available with ON/OFF Switch

For more specifications see page 389.

Connection options: A model with a QD requires a mating cordset

**Euro-Style**  
Straight connector models listed; for right-angle, add RA to the end of the model number (example, MQDC-406RA)



4-Pin
MQDC-406 2 m (6.5')
MQDC-415 5 m (15')
MQDC-430 9 m (30')



**Euro-Style QD Double-Ended**

4-Pin Straight/Straight	4-Pin Straight/Right-Angle
MQDEC-401SS 0.31 m (1')	-
MQDEC-403SS 0.91 m (3')	MQDEC-403RS 0.91 m (3')
MQDEC-406SS 2 m (6.5')	MQDEC-406RS 2 m (6.5')
MQDEC-412SS 3 m (12')	MQDEC-412RS 3 m (12')
MQDEC-420SS 6 m (20')	MQDEC-420RS 6 m (20')
MQDEC-430SS 9 m (30')	MQDEC-430RS 9 m (30')
MQDEC-450SS 15 m (50')	MQDEC-450RS 15 m (50')



**Euro-Style QD Splitter**

Length	Branches		4-Pin
	Trunk	Trunk	
0 m	0 m	0 m	CSB-M1240M1240
0.3 m	0 m	0 m	CSB-M1240M1241
0.3 m	0.3 m	0.3 m	CSB-M1241M1241
0.3 m	0.3 m	2.5 m	CSB-M1248M1241
0.3 m	0.3 m	4.6 m	CSB-M12415M1241
0.3 m	0.3 m	7.6 m	CSB-M12425M1241
0.3 m	0.3 m	7.6 m	CSB-UNT425M1241

Additional cordset information is available. See page 758



SMBWLS28RA



SMBWLS28SM



SMBWLSMAG  
Set of magnets & screws



SMBWLSMAGR  
Protective cover to prevent scratches to painted surface



PSD-24-4  
Class 2 Power Supply  
Input: 90-264 V ac 1.5A  
Output: 24 V dc 3.9A  
2 m 4-Pin Euro



WLS28-2PBQ  
In-Line Switch with M12 connector



WLS28-2MQ  
In-Line Motion Detection Switch with M12 connector

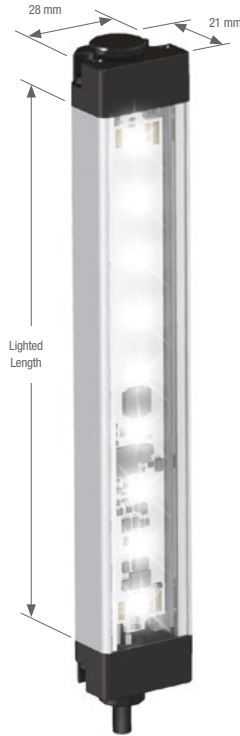

Stand Alone Cabled Models

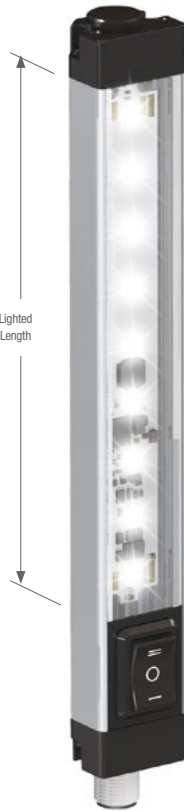

Stand Alone Push Button QD Models

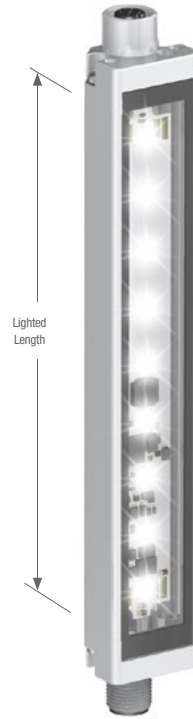

Sealed Cascadable Models





Lensed Cascade Models



Stand Alone Motion Detection QD Models

## WLS28-2 Specifications

Supply Voltage and Current	12 to 30 V dc										
	Max. current per length: 1-Color WLS28-2 (for Dual-color models, contact factory)										
	Lighted Length					Lumens* (Typical @ 25° C)					
		12 V dc	24 V dc	30 V dc	Max. Current (A)	Cool White	Warm White	Green	Red	Yellow	Blue
	145 mm	0.33 A	0.15 A	0.12 A	0.4	325	325	180	55	50	40
	285 mm	0.66 A	0.30 A	0.24 A	0.8	650	650	360	110	100	80
	430 mm	1.01 A	0.46 A	0.36 A	1.2	975	975	540	165	150	120
	570 mm	1.36 A	0.61 A	0.48 A	1.6	1300	1300	720	220	200	160
	710 mm	1.75 A	0.77 A	0.60 A	2.0	1625	1625	900	275	250	200
	850 mm	2.13 A	0.92 A	0.73 A	2.4	1950	1950	1080	330	300	240
	990 mm	2.59 A	1.08 A	0.85 A	2.8	2275	2275	1260	385	350	280
	1130 mm	3.04 A	1.24 A	0.97 A	3.2	2600	2600	1440	440	400	320
* Lumen values are reduced by 25% on diffuse window models											
Light Characteristics	<b>Color Temperature (CCT):</b> <b>1-Color: Daylight White:</b> 6,000–7,100 K <b>Warm White:</b> 2,850–3,250 K <b>Dual-Color: Daylight White:</b> 4,700–5,300 K <b>Warm White:</b> 2,850–3,250 K										
Construction	Clear anodized aluminum housing; painted zinc end caps; clear polycarbonate window; zinc plated steel brackets										
Mounting	(2) swivel brackets and (4) screws included										
Environmental Rating	IP50, IP67/IP69K										
Operating Conditions	<b>Temperature:</b> –40 to +70 °C <b>Storage Temperature:</b> –40 to +70 °C										
Application Notes	When connecting cascable lights in series it is important not to exceed maximum current limitations: Maximum length of light at 12 V dc = 1.5 m Maximum length of light at 24 V dc = 3.0 m Maximum length of light at 30 V dc = 3.1 m										
Certifications	  										

# WLS15 Series

## LED Strip Lights



- Low-profile space-saving design
- Rugged, water-resistant design
- Available in six lengths from 220 mm to 1200 mm
- Daisy chain power to multiple lights
- Optional snap clips for easy installation and repositioning
- Capability to dim lights using PWM input
- Operates on 12 V dc or 24 V dc in one model

### WLS15

Example Model Number: WLS15XDW0360DSC2

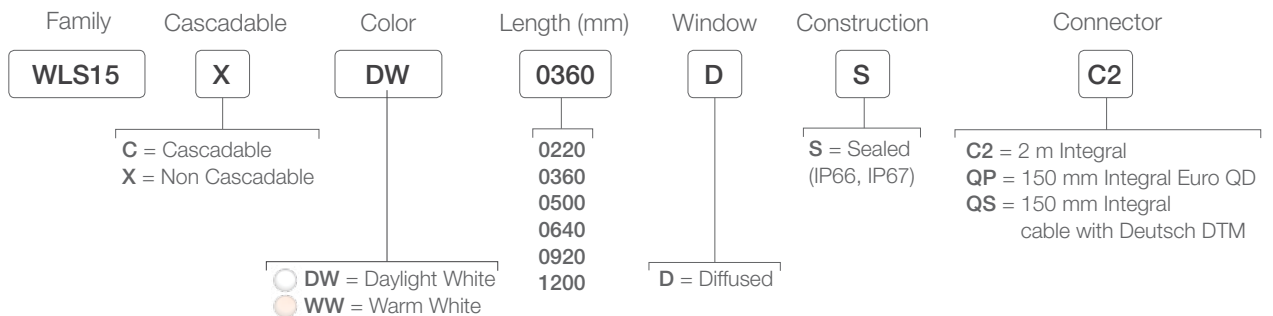

 Connection options: A model with a QD requires a mating cordset

# TOUCH BUTTONS

# PICK-TO-LIGHT

**Euro-Style**  
Straight connector models listed;  
for right-angle, add **RA** to the end  
of the model number (example,  
**MQDC-406RA**)



**4-Pin**  
**MQDC-406**  
2 m (6.5')  
**MQDC-415**  
5 m (15')  
**MQDC-430**  
9 m (30')

Additional cordset information is available.  
See page 758

**Euro-Style QD  
Double-Ended**



**4-Pin  
Straight/Straight**  
**MQDEC-401SS**  
0.31 m (1')  
**MQDEC-403SS**  
0.91 m (3')  
**MQDEC-406SS**  
2 m (6.5')  
**MQDEC-412SS**  
3 m (12')  
**MQDEC-420SS**  
6 m (20')  
**MQDEC-430SS**  
9 m (30')  
**MQDEC-450SS**  
15 m (50')

**4-Pin  
Straight/Right-Angle**  
-  
**MQDEC-403RS**  
0.91 m (3')  
**MQDEC-406RS**  
2 m (6.5')  
**MQDEC-412RS**  
3 m (12')  
**MQDEC-420RS**  
6 m (20')  
**MQDEC-430RS**  
9 m (30')  
**MQDEC-450RS**  
15 m (50')

**Euro-Style  
QD Splitter**



Length	Length		4-Pin
	Branches	Trunk	
0 m	0 m	0 m	CSB-M1240M1240
0.3 m	0 m	0 m	CSB-M1240M1241
0.3 m	0.3 m	0.3 m	CSB-M1241M1241
0.3 m	0.3 m	2.5 m	CSB-M1248M1241
0.3 m	0.3 m	4.6 m	CSB-M12415M1241
0.3 m	0.3 m	7.6 m	CSB-M12425M1241
0.3 m	0.3 m	7.6 m	CSB-UNT425M1241



LMBWLS15



LMBWLS15-150S



LMBWLS15MAG

## WLS15 Specifications

<b>Supply Voltage and Current</b>	12 V dc or 24 V dc nominal Absolute operational limits of 10 V dc to 15 V dc and 20 V dc to 27 V dc Use only with a suitable Class 2 power supply (UL) or a SELV power supply (CE) Light can be PWM dimmed between 25% to 100% with a frequency up to 1000 Hz						
	<b>Light Length (mm)</b>	<b>Typical Current (A) at 25 °C</b>		<b>Maximum Current (A) at -40 °C</b>		<b>Lumens</b>	
		12 V dc	24 V dc	12 V dc	24 V dc	Daylight White	Warm White
	0220	0.19	0.10	0.24	0.12	175	170
	0360	0.38	0.20	0.48	0.24	350	340
	0500	0.57	0.30	0.72	0.36	525	510
	0640	0.76	0.40	0.96	0.48	700	680
	0920	1.14	0.60	1.44	0.72	1050	1020
1200	1.52	0.80	1.92	0.96	1400	1360	
<b>Light Characteristics</b>	<b>Color Temperature (CCT):</b> Daylight white: 5,000 K Warm white: 3,000 K CRI: 80 minimum						
<b>Construction</b>	Clear anodized aluminum inner housing; Polycarbonate outer housing, Polyamide end caps						
<b>Mounting</b>	Integral mounting slots for M4 (#8) screws, tighten to 5 in-ibf max torque Multiple bracket options available						
<b>Environmental Rating</b>	Rated IEC IP66 and IEC IP67 Suitable for wet locations per UL 2108						
<b>Operating Conditions</b>	<b>Temperature:</b> -40 to +70 °C <b>Storage Temperature:</b> -40 to +70 °C						
<b>Application Notes</b>	When connecting cascable lights in series it is important not to exceed maximum current limitations: Maximum length of light at 12 V dc = 2.4 m Maximum length of light at 24 V dc = 6 m						
<b>Certifications</b>							

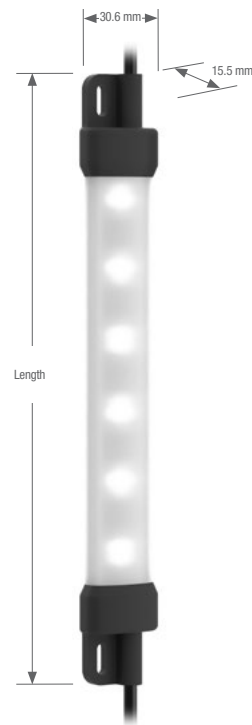

# WLB32 Series

## LED Light Bar



- Banner's WLB32 is an ultra-bright LED fixture that features an even light output for a no glare 'glow'
- Highly energy efficient for overall cost savings
- High/Low/OFF switch
- Daisy chain power to multiple lights
- Metal housing, shatterproof window
- Easy installation with snap clips, or a choice of magnetic or angle brackets

### WLB32

Example Model Number: WLB32C285PBQ

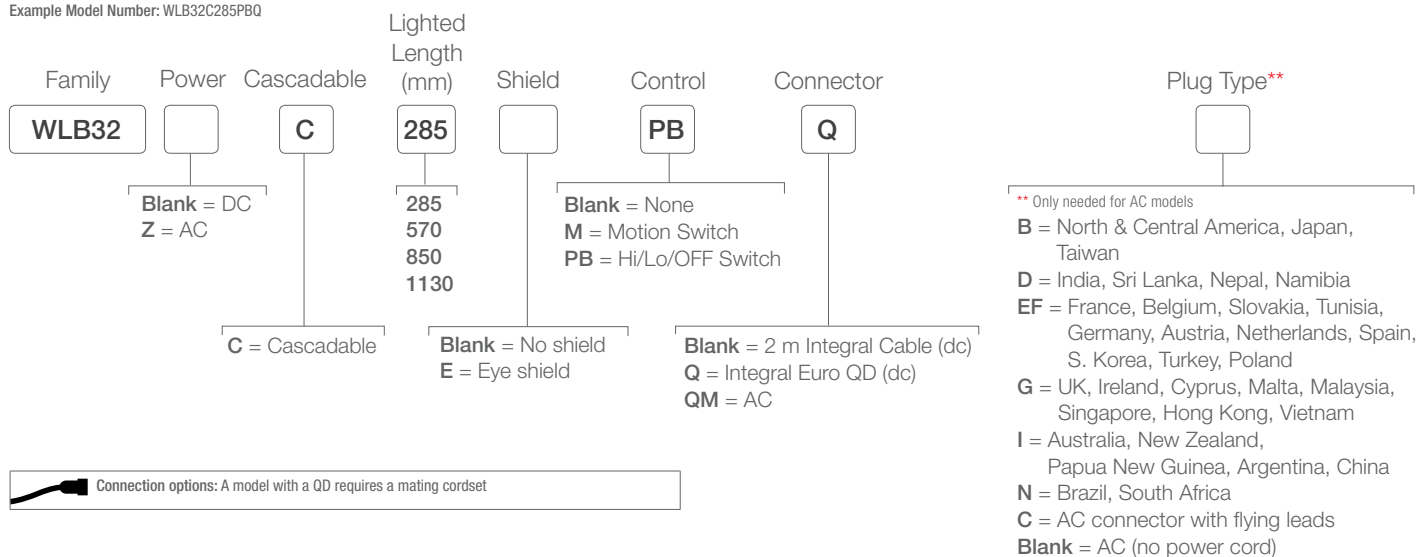

Connection options: A model with a QD requires a mating cordset

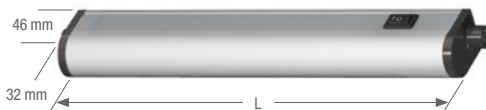

Length (L)	AC Models	DC Models
298 mm	WLB32ZC285PBQM	WLB32C285PBQ
580 mm	WLB32ZC570PBQM	WLB32C570PBQ
862 mm	WLB32ZC850PBQM	WLB32C850PBQ
1144 mm	WLB32ZC1130PBQM	WLB32C1130PBQ

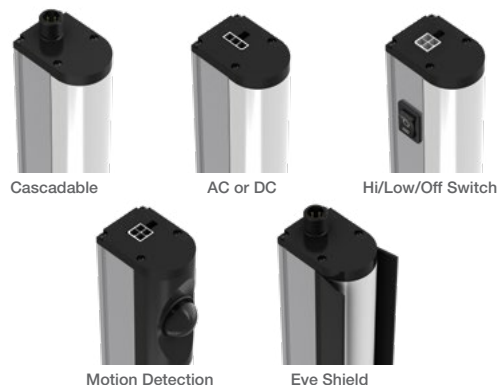



Cordsets for DC Models

**Euro-Style**  
Straight connector models listed; for right-angle, add **RA** to the end of the model number (example, **MQDC-406RA**)



4-Pin

- MQDC-406**  
2 m (6.5')
- MQDC-415**  
5 m (15')
- MQDC-430**  
9 m (30')

Cordsets for AC Models

**Double-Ended**  
NEMA 5-15 grounded  
(IEC Type B)



- LQMAC-306B**  
2 m (6.5')

**Euro-Style QD Double-Ended**  
For cascading



4-Pin  
Straight/Straight

- MQDEC-401SS**  
0.31 m (1')
- MQDEC-403SS**  
0.91 m (3')
- MQDEC-406SS**  
2 m (6.5')
- MQDEC-412SS**  
3 m (12')
- MQDEC-420SS**  
6 m (20')
- MQDEC-430SS**  
9 m (30')
- MQDEC-450SS**  
15 m (50')

4-Pin  
Straight/Right-Angle

- 
- MQDEC-403RS**  
0.91 m (3')
- MQDEC-406RS**  
2 m (6.5')
- MQDEC-412RS**  
3 m (12')
- MQDEC-420RS**  
6 m (20')
- MQDEC-430RS**  
9 m (30')
- MQDEC-450RS**  
15 m (50')

**Double-Ended**  
For Cascading



Straight/Straight

- LQMAEC-3005SS**  
0.15 m (0.5')
- LQMAEC-301SS**  
0.31 m (1')
- LQMAEC-303SS**  
0.91 m (3')
- LQMAEC-306SS**  
2 m (6.5')
- LQMAEC-312SS**  
3 m (12')
- LQMAEC-320SS**  
6 m (20')
- LQMAEC-330SS**  
9 m (30')

**Euro-Style QD Splitter**



Length	Length	
	Branches	Trunk
0 m	0 m	0 m
0.3 m	0 m	0 m
0.3 m	0.3 m	0.3 m
0.3 m	2.5 m	0.3 m
0.3 m	4.6 m	0.3 m
0.3 m	7.6 m	0.3 m
0.3 m	7.6 m	0.3 m

4-Pin

- CSB-M1240M1240**
- CSB-M1240M1241**
- CSB-M1241M1241**
- CSB-M1248M1241**
- CSB-M12415M1241**
- CSB-M12425M1241**
- CSB-UNT425M1241**



Additional cordset information is available.  
See page 758

WLB32 Specifications

Supply Voltage and Current	12 to 30 V dc 90 to 264 V ac								
	Lighted Length (mm)	Max Current Draw (A)		Typical Current Draw (A)					Lumens
DC		AC (at 90 V ac)	12 V DC	24 V DC	30 V DC	120 V ac	230 V ac		
285	0.8	0.125	0.66	0.31	0.24	0.075	0.045	650	
570	1.6	0.250	1.36	0.62	0.48	0.150	0.080	1300	
850	2.4	0.375	2.19	0.93	0.72	0.225	0.115	1950	
1130	3.2	0.500	3.02	1.24	0.96	0.300	0.150	2600	
Light Characteristics	Color: Daylight white    Color temperature (CCT): 5000K (±300K)								
Useful Life	Lumen Maintenance - L70 When operating within specifications, output will decrease less than 30% after 50,000 hours.								
Push Button	II = 100% intensity    I = 50% intensity    0 = Off								
Construction	Anodized aluminum housing; polycarbonate window and end caps; stainless steel mounting brackets								
Mounting	Snap clips; magnetic mount or swivel bracket accessories available								
Environmental Rating	IEC IP50								
Operating Conditions	DC models: -40 C to 70 °C    AC models: -25 to 45 °C								
Certifications									

# WLB92 Series

## LED Light Bar



- Increase worker productivity and ergonomics with bright, high-quality, uniform light
- Durable light stands up in your environment with a rugged metal housing and shatterproof light cover
- No maintenance time or cost with long-life, energy-efficient LEDs
- Flexibility to place light where needed with ac and dc models
- Easy installation with variety of mounting options: surface, swivel, snap and hanging brackets
- AC models are DLC certified and have a five year warranty
- Dimmable models available see page 408

### WLB92, 24 V DC

Example Model Number: WLB92X550PBQ

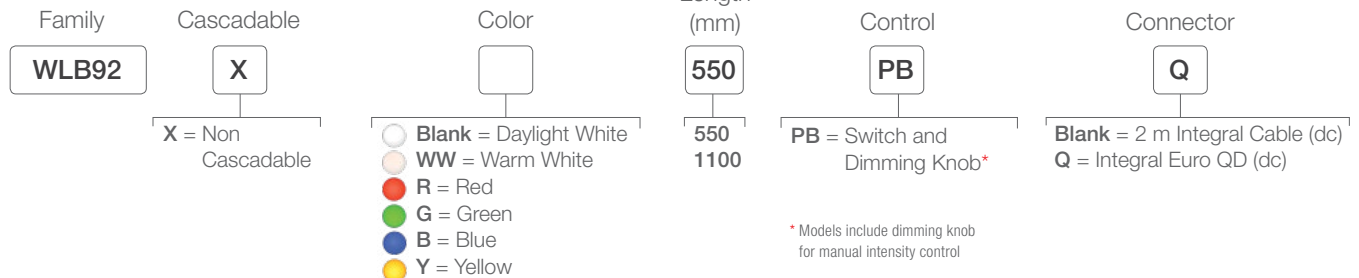

### WLB92, 100-277 V AC

Example Model Number: WLB92ZC550PBQMB

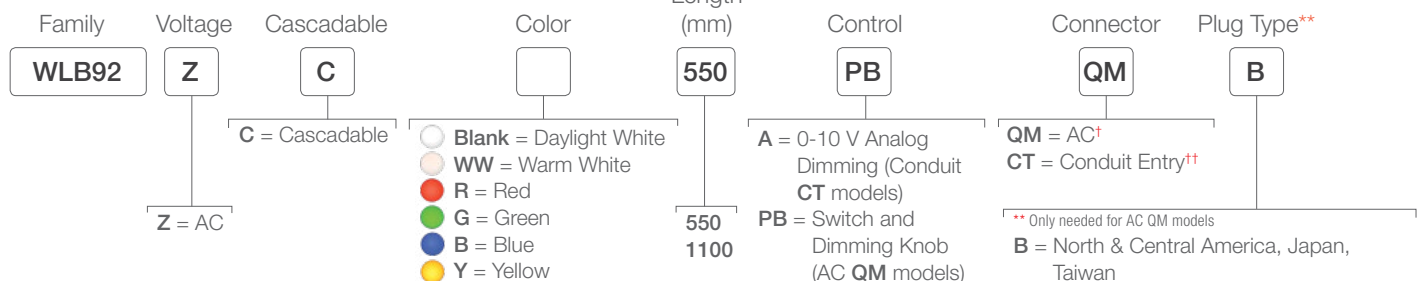

† Models with a connector include ON/OFF switch as well as a dimming knob for intensity control  
 †† Conduit entry models include dimmability via a 0 to 10 V input circuit

\*\* Only needed for AC QM models  
**B** = North & Central America, Japan, Taiwan  
**D** = India, Sri Lanka, Nepal, Namibia  
**EF** = France, Belgium, Slovakia, Tunisia, Germany, Austria, Netherlands, Spain, S. Korea, Turkey, Poland  
**G** = UK, Ireland, Cyprus, Malta, Malaysia, Singapore, Hong Kong, Vietnam  
**I** = Australia, New Zealand, Papua New Guinea, Argentina, China  
**N** = Brazil, South Africa  
**C** = AC connector with flying leads  
**Blank** = AC (no power cord)

Connection options: A model with a QD requires a mating cordset

## Cordsets for DC Models

## Euro-Style

Straight connector models listed; for right-angle, add **RA** to the end of the model number (example, **MQDC-406RA**)



**4-Pin**  
**MQDC-406**  
 2 m (6.5')  
**MQDC-415**  
 5 m (15')  
**MQDC-430**  
 9 m (30')

Additional cordset information is available.  
 See page 758

## Cordsets for AC Models

**Double-Ended**  
 For Cascading



**Straight/Straight**  
**LQMAEC-3005SS**  
 0.15 m (0.5')  
**LQMAEC-301SS**  
 0.31 m (1')  
**LQMAEC-303SS**  
 0.91 m (3')  
**LQMAEC-306SS**  
 2 m (6.5')  
**LQMAEC-312SS**  
 3 m (12')  
**LQMAEC-320SS**  
 6 m (20')  
**LQMAEC-330SS**  
 9 m (30')

**Double-Ended**  
 NEMA 5-15 grounded  
 (IEC Type B)



**LQMAC-306B**  
 2 m (6.5')



LMBWL92



LMBWL92CLIP



LMBWL92HK5



LMBWL92S



LMBWL92RAS

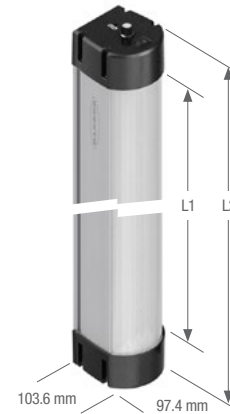

Length (L1)	Length (L2)	Model
543 mm	665 mm	WLB92...550..
1098 mm	1220 mm	WLB92...1100..

## WLB92 Specifications

Supply Voltage and Current	24 V dc +/- 10% 100 to 277 V ac						
	Lighted Length (mm)	Max Current Draw (A)		Typical Current Draw (A)			Lumens
		DC	AC (at 90 V ac)	24 V DC	120 V ac	230 V ac	
550	1.75 A	0.425 A	1.45 A	0.295 A	0.160 A	0.145 A	3130
1100	3.5 A	0.850 A	2.9 A	0.590 A	0.310 A	0.260 A	6500
Light Characteristics	Color: Daylight white Color temperature (CCT): 5000K (±300K)			Color: Warm white Color temperature (CCT): 3,000 K			
Useful Life	Lumen Maintenance - L70 When operating within specifications, output will decrease less than 30% after 50,000 hours.						
Construction	Anodized aluminum housing; polycarbonate window and end caps						
Mounting	Several options available; see above and datasheet						
Environmental Rating	IEC IP40						
Operating Conditions	See datasheet						
Certifications	AC daylight white models only						

# WLS27 Series

## LED Light Bar



- Sturdy internal aluminum housings, encased in shatterproof, UV-stabilized, copolyester shells
- Round shape makes them suitable for laminar airflow applications
- Rugged, water-resistant IP66, IP67 and IP69K design
- Daisy chain power to multiple lights
- Capability to dim lights using the wiring pinout (Hi/Lo/Off)
- Automatic temperature protection built into the unit extends the product life
- Single- and dual-colored models available
- Dimmable models available see page 408

### WLS27

Example Model Number: WLS27XW285DSPWMQ

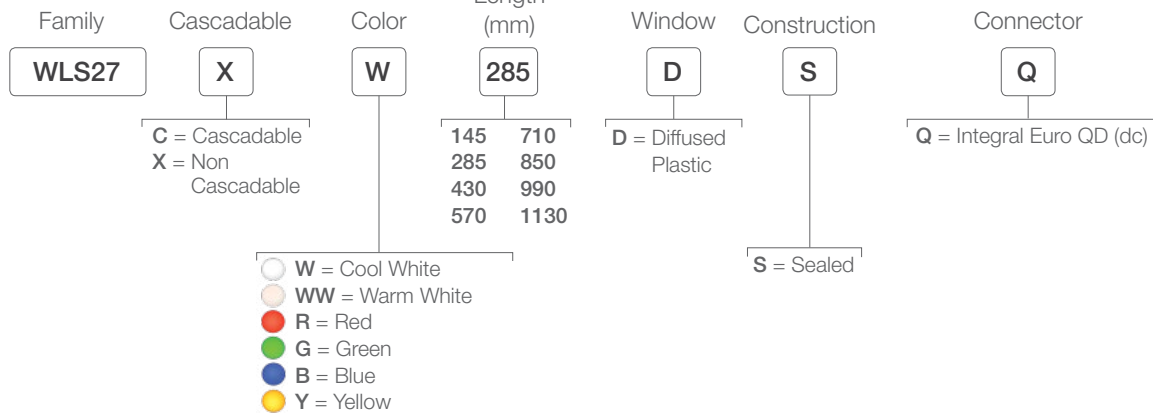

### Dual-Color WLS27

Example Model Number: WLS27XWR2-285DSQ

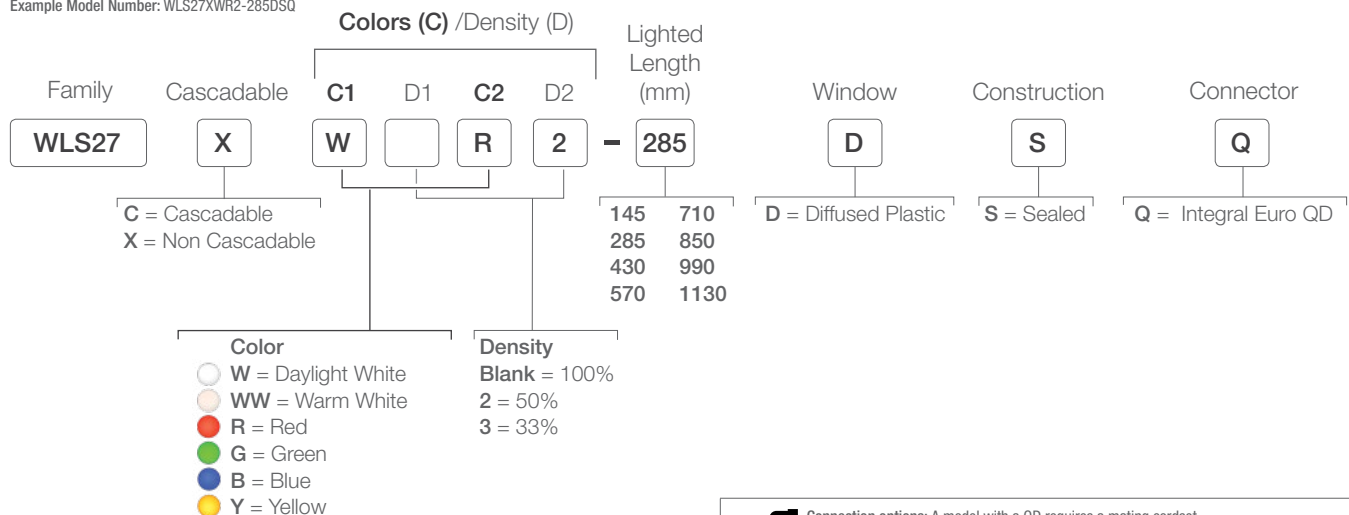

Connection options: A model with a QD requires a mating cordset

Standard

**Euro-Style**  
Straight connector models listed; for right-angle, add **RA** to the end of the model number (example, **MQDC-406RA**)



**4-Pin**  
**MQDC-406**  
2 m (6.5')  
**MQDC-415**  
5 m (15')  
**MQDC-430**  
9 m (30')

**Euro-Style QD Double-Ended**



**4-Pin Straight/Straight**  
**MQDEC-401SS**  
0.3 m (1')  
**MQDEC-403SS**  
1 m (3')  
**MQDEC-406SS**  
2 m (6.5')



**Euro-Style QD Splitter**

Length	Length		4-Pin
	Branches	Trunk	
0.3 m	0.3 m		<b>CSB-M1241M1241</b>

IP69K Washdown

**M12 Euro-Style Washdown Cordset**  
Straight connector models only



**4-Pin**  
**MQDC-WDSS-0406**  
2 m (6.5')  
**MQDC-WDSS-0415**  
5 m (15')  
**MQDC-WDSS-0430**  
9 m (30')

**Euro-Style QD Double-Ended Washdown**



**4-Pin Straight/Straight**  
**MQDEC-WDSS-401SS**  
0.3 m (1')  
**MQDEC-WDSS-403SS**  
1 m (3')  
**MQDEC-WDSS-406SS**  
2 m (6.5')

Additional cordset information is available. See page 758



**WLS28-2PBQ**  
In-Line Switch with M12 connector



**WLS28-2MQ**  
In-Line Motion Detection Switch with M12 connector



LMBWLS27EC



LMBWLS27H



LMBWLS27U



LMBWLS27SP



First or Middle of Cascade

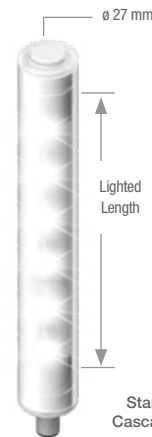

Stand-Alone or Cascade End Light

Length (mm)	One-Color WLS27 Lumens (Typical @ 25 °C)						Typical Wattage* (Watts)
	Cool White	Warm White	Red	Green	Blue	Yellow	
145	325	325	55	180	40	50	3.6
285	650	650	110	360	80	100	7.2
430	975	975	165	540	120	150	11.0
570	1300	1300	220	720	160	200	14.6
710	1625	1625	275	900	200	250	18.5
850	1950	1950	330	1080	240	300	22.1
990	2275	2275	385	1260	280	350	25.9
1130	2600	2600	440	1440	320	400	29.8

\*Typical operating wattage is measured at 24 V dc

WLS27 Specifications

Supply Voltage and Current	12 to 30 V dc									
	Lighted Length (mm)	Typical Current Draw (A)			Max. Current (A)	Lighted Length (mm)	Typical Current Draw (A)			Max. Current (A)
		12 V dc	24 V dc	30 V dc			12 V dc	24 V dc	30 V dc	
	145	0.33 A	0.15 A	0.12 A	0.4	710	1.75 A	0.77 A	0.60 A	2.0
	285	0.66 A	0.30 A	0.24 A	0.8	850	2.13 A	0.92 A	0.73 A	2.4
	430	1.01 A	0.46 A	0.36 A	1.2	990	2.59 A	1.08 A	0.85 A	2.8
	570	1.36 A	0.61 A	0.48 A	1.6	1130	3.04 A	1.24 A	0.97 A	3.2
Light Characteristics	<b>Color:</b> Cool white <b>Color temperature (CCT):</b> 6000–7100K									
Useful Life	Lumen Maintenance - L70 When operating within specifications, output will decrease less than 30% after 50,000 hours.									
Construction	Clear anodized aluminum housing; FDA-grade copolyester outer housing									
Mounting	Bracket <b>LMBWLS27EC</b> included (2 for lights up to 570 mm or 3 for lights 710 mm and longer); see datasheet for additional options									
Environmental Rating	IEC IP66, IP67, and IP69K, per DIN 40050									
Operating Conditions	-40 to +70 °C									
Certifications										

# WLC60 Series

## Heavy-Duty LED Light



- LED technology delivers best in class brightness
- Oil, chemical and water resistant with IP67, IP68g and IP69K ratings
- High brightness paired with advanced glare-reducing optics
- Easy to install with a wide variety of mounting solutions
- Highly resistant to vibration and shock
- All models have three discrete intensity level settings
- Dimmable models available see page 409

### WLC60

Example Model Number: WLC60XW340GAQ

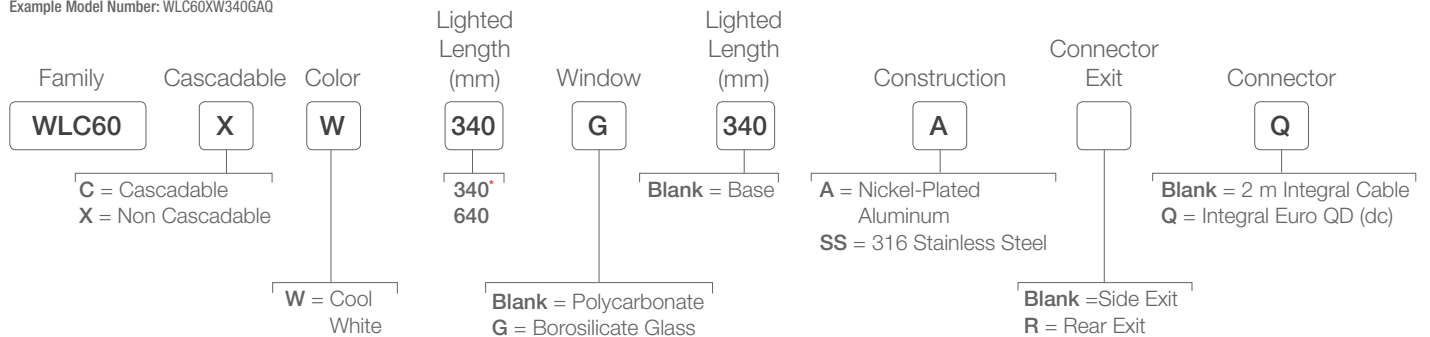

\* Flush mount, rear exit, and stainless steel options are only available in 340 mm length

 Connection options: A model with a QD requires a mating cordset

## Standard

## Euro-Style

Straight connector models listed; for right-angle, add **RA** to the end of the model number (example, **MQDC-406RA**)



4-Pin

**MQDC-406**  
2 m (6.5')  
**MQDC-415**  
5 m (15')  
**MQDC-430**  
9 m (30')

**Euro-Style QD  
Double-Ended**

4-Pin  
Straight/Straight

**MQDEC-401SS-PUR**  
0.3 m (1')  
**MQDEC-403SS-PUR**  
1 m (3')  
**MQDEC-406SS-PUR**  
2 m (6.5')

IP69K  
Washdown

**M12 Euro-Style  
Washdown Cordset**  
Straight connector  
models only



4-Pin

**MQDC-WDSS-0406**  
2 m (6.5')  
**MQDC-WDSS-0415**  
5 m (15')  
**MQDC-WDSS-0430**  
9 m (30')

Additional cordset information is available.  
See page 758



LMBWLC60F



LMBWLC60RA



LMBWLC60RA



LMBWLC60MAG



## PSD-24-4

Class 2 Power Supply  
Input: 90-264 V ac 1.5A  
Output: 24 V dc 3.9A  
2 m 4-Pin Euro

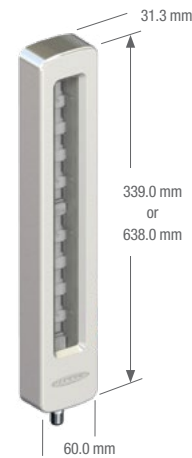

Base Mount

## WLC60 Specifications

Supply Voltage and Current	12 to 30 V dc Max. current per length:					
	Light Length	12 V dc	24 V dc	30 V dc	Watts	Lumens (Typical @ 25° C) Cool White
	340 mm	1.4 A	0.7 A	0.56 A	16.8	1300
	640 mm	3.1 A	1.53 A	1.22 A	37.2	2600
Light Characteristics	<b>Color:</b> Cool white <b>Color temperature (CCT):</b> 6,000–7,100K					
Construction	Nickel plated aluminum or 316 stainless steel housing, polycarbonate or borosilicate glass window					
Environmental Rating	IEC IP67/IP68g / IP69K per DIN 40050					
Connections	Integral 4-pin Euro style QD or 2 m integral cable, depending on model. QD cordsets are ordered separately.					
Operating Conditions	<b>Temperature:</b> Max intensity –40 to +50 °C Dim settings –40 to +70 °C <b>Storage Temperature:</b> –40 to +70 °C					
Application Notes	When connecting cascadable lights in series, it is important not to exceed the maximum current limitation of 4 Amps. See datasheet for more information.					
Certifications						



# WLC90 Series

## Heavy-Duty LED Light



- Rugged housing resists water, coolants, oils and detergent with IP67, IP68g and IP69K and ratings
- Wide operating temperature range with an internal monitoring circuit that will dim the LEDs to a safe level at extreme temperatures
- Three lens options to suit many application needs
- Pan and tilt brackets for versatile mounting to direct light in any direction
- All models have three discrete intensity level settings
- Dimmable models available see page 409

### WLC90

Example Model Number: WLC90WGL15Q

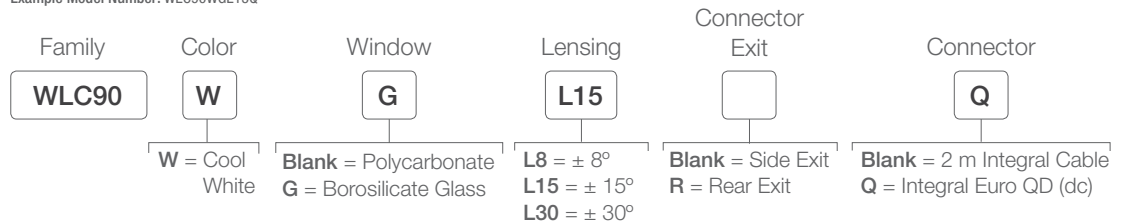

 Connection options: A model with a QD requires a mating cordset

## Standard

## Euro-Style

Straight connector models listed; for right-angle, add **RA** to the end of the model number (example, **MQDC-406RA**)



4-Pin

**MQDC-406**  
2 m (6.5')  
**MQDC-415**  
5 m (15')  
**MQDC-430**  
9 m (30')

## IP69K Washdown

**M12 Euro-Style**  
Washdown cordset  
straight connector  
models only



4-Pin

**MQDC-WDSS-0406**  
2 m (6.5')  
**MQDC-WDSS-0415**  
5 m (15')  
**MQDC-WDSS-0430**  
9 m (30')

Additional cordset information is available.  
See page 758



LMBWLC90PT



SMBAMS70AS



**PSD-24-4**  
Class 2 Power Supply  
Input: 90-264 V ac 1.5A  
Output: 24 V dc 3.9A  
2 m 4-Pin Euro

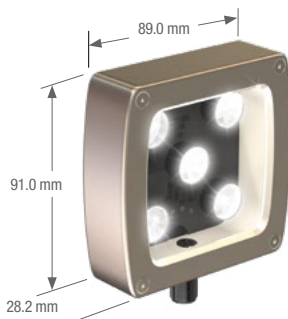

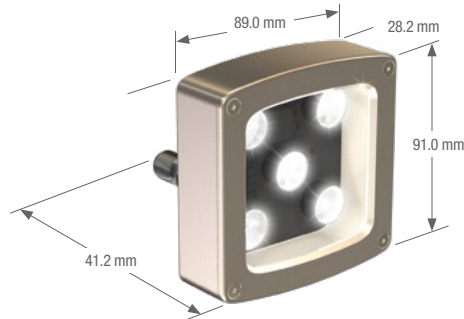

Side Exit



Rear Exit

## WLC90 Specifications

Supply Voltage and Current	12 to 30 V dc <b>Max. current:</b> 850 mA at 12 V dc 410 mA at 24 V dc 330 mA at 30 V dc <b>Max. input power:</b> 10.2 Watts
Light Characteristics	<b>Color:</b> Cool white <b>Color temperature (CCT):</b> 6,000–7,100K
Construction	Nickel plated aluminum housing, polycarbonate or borosilicate glass window
Environmental Rating	IEC IP67/IP68g / IP69K per DIN 40050
Operating Conditions	<b>Temperature:</b> Max intensity –40 to +70 °C <b>Storage Temperature:</b> –40 to +70 °C
Certifications	 

# WLA Series

## LED Area Light



- Up to 2200 lumens for extremely bright illumination
- Encapsulated models available for enhanced resistance to chemicals, vibration and shock
- Choice of clear or diffuse window for reduced glare
- Optical lensed options create more focused illumination
- Rugged housing rated to IP69K for high-pressure, high-temperature washdown applications
- Dimmable models available see page 409

### WLA

Example Model Number: WLAW105X180DL11Q



\* Encapsulated models only available in cool white with no lens

Connection options: A model with a QD requires a mating cordset

Standard



4-Pin

Euro-Style

Straight connector models listed; for right-angle, add **RA** to the end of the model number (example, **MQDC-406RA**)

- MQDC-406**  
2 m (6.5')
- MQDC-415**  
5 m (15')
- MQDC-430**  
9 m (30')

IP69K Washdown



4-Pin

**M12 Euro-Style**  
Washdown Cordset  
Straight connector models only

- MQDC-WDSS-0406**  
2 m (6.5')
- MQDC-WDSS-0415**  
5 m (15')
- MQDC-WDSS-0430**  
9 m (30')

Additional cordset information is available. See page 758



SMBBSSM



SMBBSRA



**SMBWLAMAG**  
Set of four magnets & screws



**PSD-24-4**  
Class 2 Power Supply  
Input: 90-264 V ac 1.5A  
Output: 24 V dc 3.9A  
2 m 4-Pin Euro



WLA Specifications

Supply Voltage and Current	12 to 30 V dc (10% max. ripple) <b>Max. current per length:</b>									
						Lumens* (Typical @ 25° C)				
Size	12 V dc	24 V dc	30 V dc	Watts	Cool White	Warm White	Green	Red	Yellow	Blue
<b>WLAW105X180</b>	0.8A	0.5A	0.32A	9.6	550	435	325	125	275	95
<b>WLAW190X180</b>	1.6A	0.8A	0.64A	19.2	1100	870	650	250	550	190
<b>WLAW275X180</b>	2.4A	1.2A	0.96A	28.8	1650	1305	975	375	825	285
<b>WLAW360X180</b>	3.2A	1.6A	1.28A	38.4	2200	1740	1300	500	1100	380
* Diffuse models have 35% less Lumens										
Light Characteristics	<b>Color Temperature (CCT): Cool White: 6,000-7,100K, Warm White: 2,800-3,200K</b>									
Construction	PBT housing; acrylic window, nickel-plated brass connector									
Environmental Rating	IP69K and IP67									
Operating Conditions	<b>Temperature:</b> -20 to +50 °C <b>Relative Humidity:</b> 95% (non-condensing) <b>Storage Temperature:</b> -40 to +70 °C									
Certifications										

# WL50S Series

## LED Spot Work Light



- Three lens options to suit many application needs
- Rugged, sealed housing rated to IP69K
- 50 mm diameter with flat profile and 30 mm mounting base
- Stainless steel version with FDA-grade silicone gasket and Viton® O-Ring seal
- Many bracket options for simple mounting and alignment
- Dimmable models available contact factory

### WLS50

Example Model Number: WL50SWL11Q

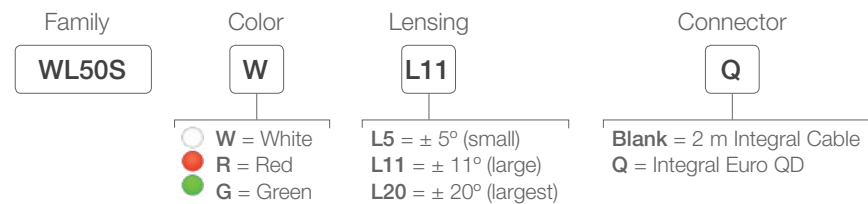

### WLS50, Stainless Steel

Example Model Number: WL50SWSSL11Q

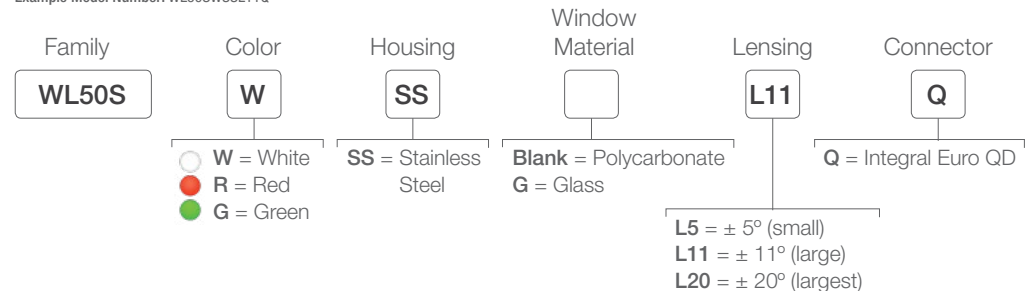

 Connection options: A model with a QD requires a mating cordset



4-Pin

**Euro-Style**

Straight connector models listed; for right-angle, add **RA** to the end of the model number (example, **MQDC-406RA**)

**MQDC-406**  
2 m (6.5')  
**MQDC-415**  
5 m (15')  
**MQDC-430**  
9 m (30')



5-Pin

**Euro-Style**

Stainless steel for washdown. Straight connector models only

**MQDCWD-506**  
2 m (6.5')  
**MQDCWD-530**  
9 m (30')

Additional cordset information is available  
See page 758.



SMB30A

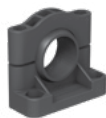

SMB30SC

Additional bracket information is available  
See page 727.



FLX18

Additional flex arm  
information is available  
See page 410



WL50S



WL50S Stainless Steel

## WL50S Specifications

<b>Supply Voltage and Current</b>	12 to 30 V dc, 400 mA max.				
<b>Light Characteristics</b> (Aluminum and Stainless Steel models)	<b>Lens Angle</b>	<b>Model</b>	<b>LED Color</b>	<b>Window Material</b>	<b>Lumens* (Typical @ 25° C)</b>
	±5° (smaller, more focused spot)	<b>WL50SWL5Q</b>	White	Polycarbonate	295
		<b>WL50SRL5Q</b>	Red	Polycarbonate	110
		<b>WL50SGL5Q</b>	Green	Polycarbonate	210
	±11° (larger spot)	<b>WL50SWL11Q</b>	White	Polycarbonate	285
		<b>WL50SRL11Q</b>	Red	Polycarbonate	105
		<b>WL50SGL11Q</b>	Green	Polycarbonate	200
	±20° (largest spot)	<b>WL50SWL20Q</b>	White	Polycarbonate	270
		<b>WL50SRL20Q</b>	Red	Polycarbonate	100
		<b>WL50SGL20Q</b>	Green	Polycarbonate	190
<b>Color Temperature (CCT): White: 5,000-8,300 K</b>					
<b>Supply Protection Circuitry</b>	Protected against reverse polarity and transient voltages				
<b>Construction</b>	<b>WL50S..:</b> Black anodized aluminum housing; polycarbonate window; nickel-plated QD connector or PVC-jacketed cable; black zinc-plated steel mounting nut <b>WL50SS..:</b> 316 stainless steel housing, polycarbonate or glass window with Viton seal, 316 stainless steel M30 mounting nut, FDA grade silicone base gasket				
<b>Useful Life</b>	When operating within specifications, output will decrease less than 30% after 50,000 hours				
<b>Environmental Rating</b>	IEC IP67, IP69K per DIN 40050-9				
<b>Operating Conditions</b>	<b>Temperature:</b> -20 to +50 °C <b>Relative Humidity:</b> 95% (non-condensing) <b>Storage Temperature:</b> -40 to +70 °C				
<b>Vibration and Mechanical Shock</b>	All models meet Mil. Std. 202F requirements method 201A (vibration: 10 to 60 Hz max., double amplitude 0.06", maximum acceleration 10G). Also meets IEC 947-5-2; 30G 11 ms duration, half sine wave.				
<b>Certification</b>					

# WL50 Series

## LED Work Light



- Low power consumption
- Aesthetic shape that sheds debris and moisture
- Rugged, water-resistant IP69K models
- VELCRO® brand VELCOIN® fasteners included for quick mounting and convenient repositioning of light
- Long-lasting LED technology for zero maintenance after installation
- Dimmable models available contact factory

### WL50-2

Example Model Number: WL50-2Q

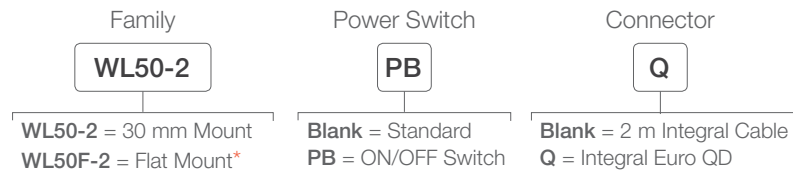

 Connection options: A model with a QD requires a mating cordset

For 9 m cable, add suffix W/30 to 2 m model number (example, WL50F W/30).

QD models: For a 4-pin 150 mm Euro-style pigtail QD, add suffix QP to 2 m model number (example, WL50FQP).

\* Flat-mount models include a 48 mm circular Velcro® mounting kit for easy mounting.



**Euro-Style**

Straight connector models listed;  
for right-angle, add **RA** to the end  
of the model number (example,  
**MQDC-406RA**)

**4-Pin**

**MQDC-406**  
2 m (6.5')  
**MQDC-415**  
5 m (15')  
**MQDC-430**  
9 m (30')

*Additional cordset information is available  
See page 758.*

**FLX18**

*Additional flex arm  
information is available  
See page 410*



## WL50-2 Specifications

Supply Voltage	12 to 30 V dc <b>Max. current:</b> 233 mA @ 12 V dc; 110 mA @ 24 V DC, 90 mA @ 30 V dc <b>Max. input power:</b> 2.8 watts
Light Characteristics	<b>Color temperature (CCT):</b> 6,000 to 7,100 K <b>Color:</b> Cool white <b>Lumens:</b> 185
Power-up Response Time	<b>Light ON:</b> 1 millisecond max. (models without push button)
Construction	Polycarbonate housing; Nickel-plated QD connector or PVC-jacketed cable
Environmental Rating	<b>Standard models:</b> IP67, IP69K per DIN 40050 <b>Push button models:</b> IEC IP67
Operating Conditions	<b>Temperature:</b> -40° to +50° C <b>Relative Humidity:</b> 95% (non-condensing) <b>Storage Temperature:</b> -40° to +70° C
Application Note	<b>Push button models:</b> When power is initially applied to the device, or following a power interruption and the light is off, push the push button to turn the light on.
Certification	

# LC65P1T

## LED Dimming Controller



The LED Pulse-Width Modulation (PWM) Dimming Controller allows an operator to dim an LED light source without loss of accuracy.

- Paired with Banner's LED lighting helps further increase energy savings, helping to reduce overall energy costs
- Ability to dim light at an operator station
- Works with special models of the strip lights, heavy-duty lights, area lights, spot lights and work lights
- Allows for control of multiple lights with one module
- Compact and easy to install
- Model keys below configured for use with Dimming Controller (LC65P1T ordered separately)

### WLS27 LED Strip Light



page 396

Family	Cascadable	Color	Lighted Length (mm)	Window	Construction	Intensity Control	Connector
<b>WLS27</b>	<b>X</b>	<b>W</b>	<b>285</b>	<b>D</b>	<b>S</b>	<b>PWM</b>	<b>Q</b>
	C = Cascadable X = Non Cascadable	W = Daylight White	145 710 285 850 430 990 570 1130	D = Diffused Plastic	S = Sealed	PWM = Dimmable via Pulse Width Modulation	Q = Integral Euro QD

### WLS28-2 LED Strip Lights



page 386

Family	Cascadable	LED Color	Lighted Length (mm)	Window	Construction	Intensity Control	Connector
<b>WLS28-2</b>	<b>C</b>	<b>W</b>	<b>145</b>		<b>X</b>	<b>PWM</b>	<b>Q</b>
	C = Cascadable X = Non Cascadable	W = Cool White	145 570 990 285 710 430 850	Blank = Clear Plastic D = Diffused Plastic L25 = 25° Lensed Window	S = Sealed X = Not Sealed	PWM Dimming	Blank = 2 m Integral Cable Q = Integral Euro QD

### WLB92 Light Bar



page 394

Family	Cascadable	Color	Lighted Length (mm)	Control	Connector
<b>WLB92</b>	<b>X</b>		<b>550</b>	<b>PWM</b>	<b>Q</b>
	X = Non Cascadable	Blank = Daylight White	550 1100	PWM = Dimmable via Pulse Width Modulation	Blank = 2 m Integral Cable (dc) Q = Integral Euro QD (dc)

WLA LED Area Lights



page 402

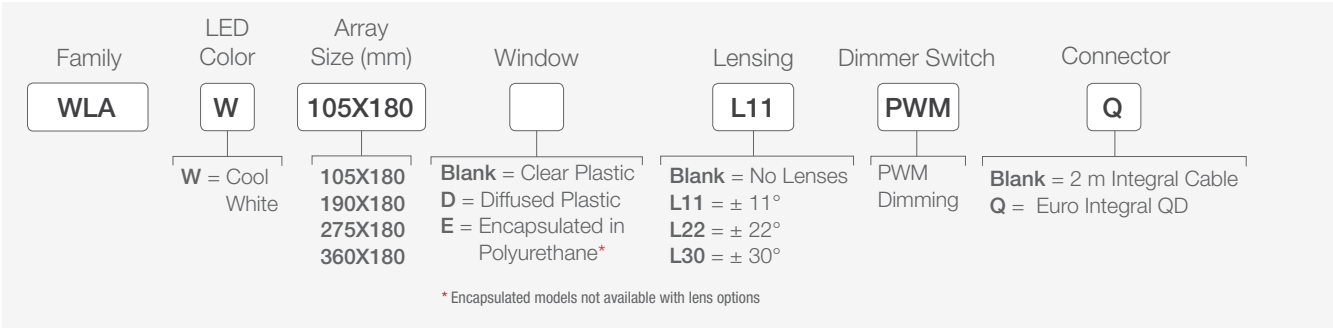

WLC90 Heavy-Duty LED Light



page 400

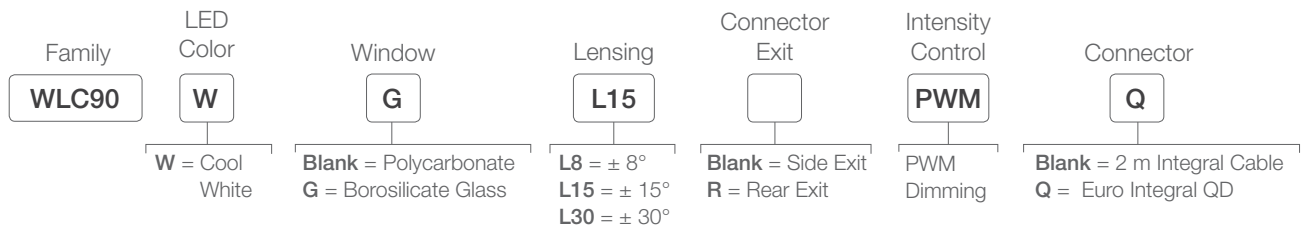

WLC60 Heavy-Duty LED Light



page 398

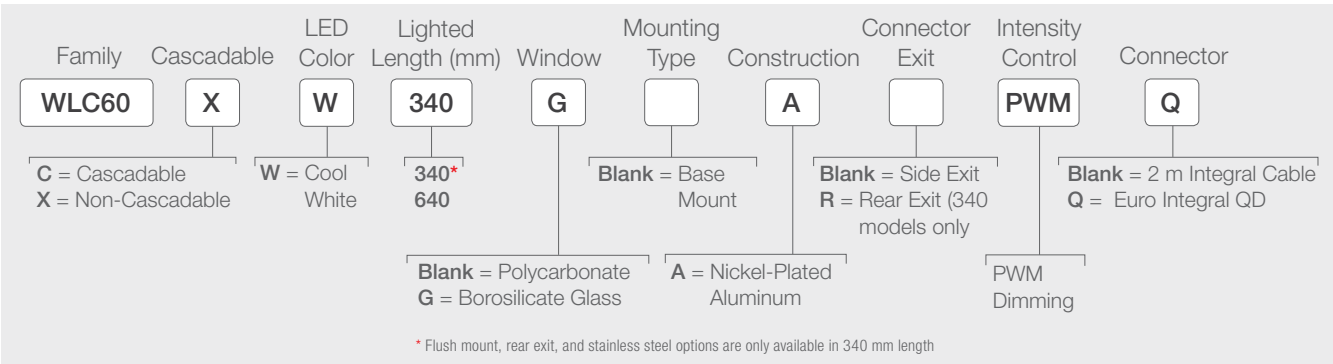

page 404



page 406

WL50S and WL50-2 also have the PWM option available. Contact factory for more information

Connection options: A model with a QD requires a mating cordset

# Flex Arm









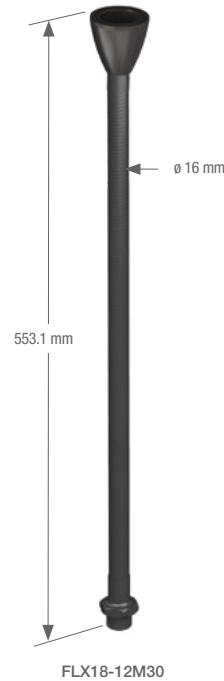
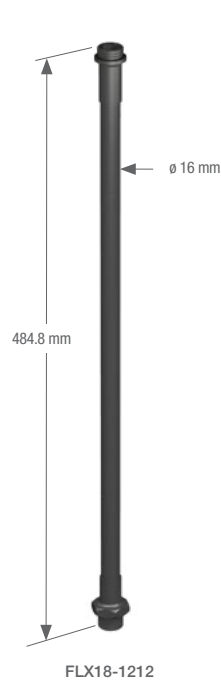





## For Work Lights



Banner's Flex Arm Mounting Accessories provide versatile mounting options to easily direct lighting where it is needed, whether in a work station or along a manufacturing line. The Flex Arm is available for use with spot lights, work lights and vision spot lights.

- Versatile mounting options including magnetic mount, clamp mount and flange mount
- Vinyl coated to protect against moisture
- Adjustable arm allows for easy repositioning of light to suit many application needs
- Concentrate light exactly where needed
- Portability with magnetic and clamp mount options



Models	Base Connection	Light Connection	Brackets		
FLX18-1212	 1/2-14 NPSM	 1/2-14 NPSM (Male) Use with: WL50-2 WL50-2PB	 SMB22	 SMBFLXMAG	 LMB12RA
FLX18-F12	 3-Hole Flange	 1/2-14 NPSM (Male) Use with: WL50-2 WL50-2PB	Direct Mount		
FLX18-12M30	 1/2-14 NPSM	 M30 x 1.5 (Female) Use with: WL50-2 WL50-2PB WL50S	 SMB22	 SMBFLXMAG	 LMBE12RA
FLX18-DM30	 2 x 1/4-20W 1.375 spacing	 M30 x 1.5 (Female) Use with: WL50-2 WL50-2PB WL50S	 SMBFLXCLAMPD	 SMBFLXMAGD	
FLX18-FM30	 3-Hole Flange	 M30 x 1.5 (Female) Use with: WL50-2 WL50-2PB WL50S	Direct Mount		



---

## Tower Lights

Banner's Tower Lights are designed to be exceptionally bright with a long, visible indication range, providing excellent operational status for workers and supervisors. Several models are available for use in a variety of environments, including options with audible alerts.

Series	Description	Number of Segments	Brightness	Dimensions	Power Supply	Communication
	<b>TL70</b> Designed to be exceptionally bright with a long, visible indication range, providing excellent operational status for workers and supervisors. page 414	1 to 6	High-Brightness	30 mm base Height varies by model	DC or AC models available	Wireless option
	<b>TL50</b> Designed to be exceptionally bright with a long, visible indication range, providing excellent operational status for workers and supervisors. page 418	1 to 7	Standard or High-Brightness	30 mm base Height varies by model	DC or AC models available	IO-Link option
	<b>TL50C</b> Compact design makes them ideal for status indication on small to mid-size pieces of equipment. page 422	1 to 7	Standard	30 mm base Height varies by model	DC or AC models available	NA
	<b>TL50BL</b> Extremely rugged and built for use in the toughest industrial environments. With a sleek and stylish design, the TL50 Beacon's housing is UV stabilized, making it suitable for use in outdoor environments. page 426	1 to 5	Daylight Visible	30 mm base Height varies by model	DC or AC models available	NA
	<b>CL50</b> Illumination provides easy-to-see operator guidance and equipment status indication for workers and supervisors. page 430	1	Standard	30 mm base Height varies by model	DC or AC models available	NA

# TL70 Series

## Tower Lights



- Light segments have user-selectable solid ON or flashing
- Up to light segments (six color options) or five segments plus an audible in one device
- Rugged, water-resistant IP65 housing with UV stabilized material
- Bright, uniform indicator segments appear gray when off to eliminate false indication from ambient light
- Cordsets and brackets see page 432

LASER MARKING AVAILABLE

### Preassembled TL70 DC Tower Lights

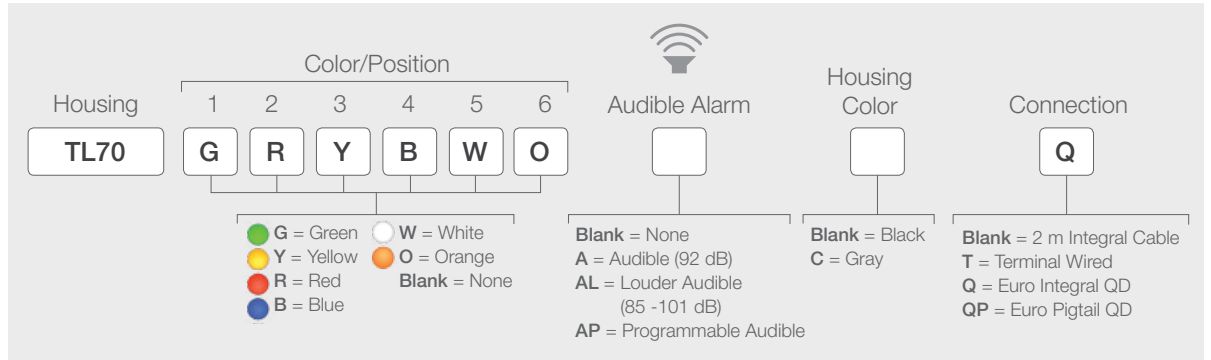

### Build Your Own TL70 DC Tower Lights

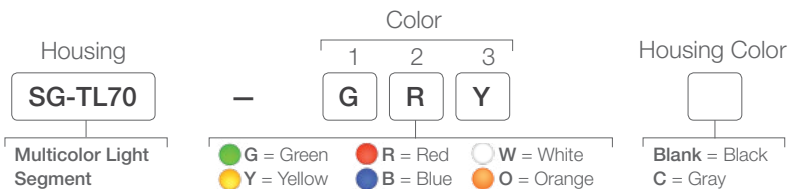
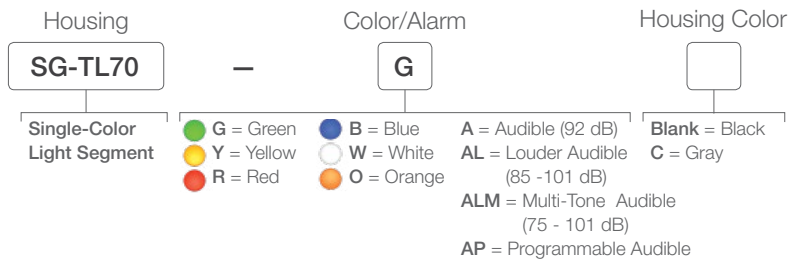
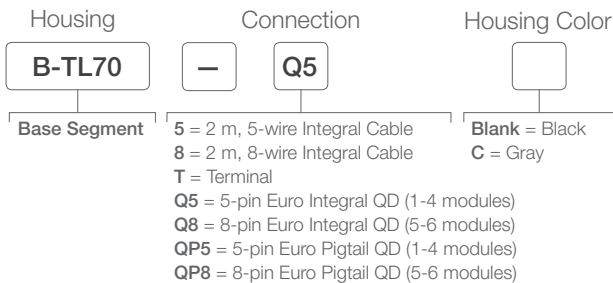

For more specifications see page 417.

Connection options: A model with a QD requires a mating cordset (see page 432).



Preassembled TL70 AC Tower Lights

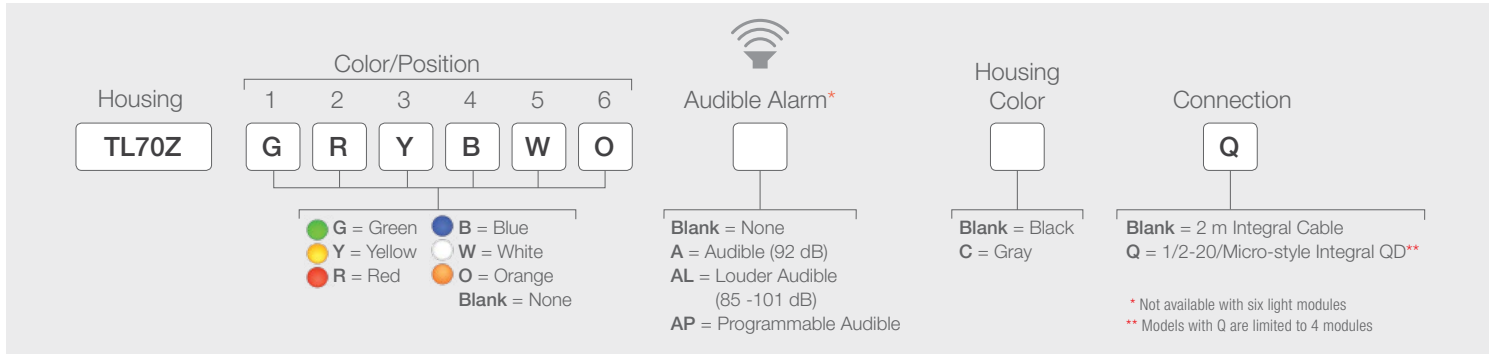

Build Your Own TL70 AC Tower Lights



Preassembled TL70 Wireless Tower Lights

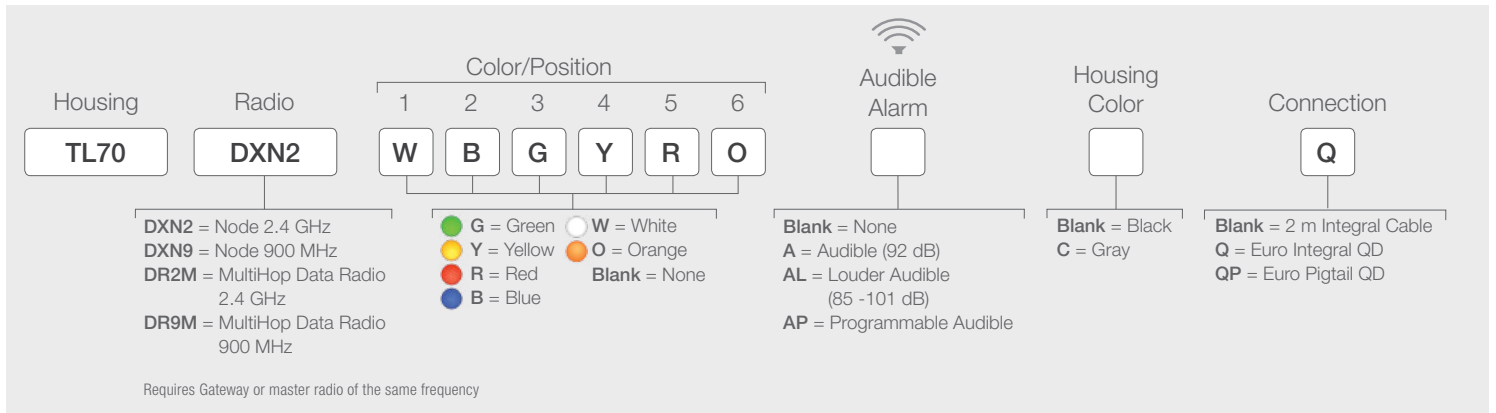

Build Your Own TL70 Wireless Tower Lights

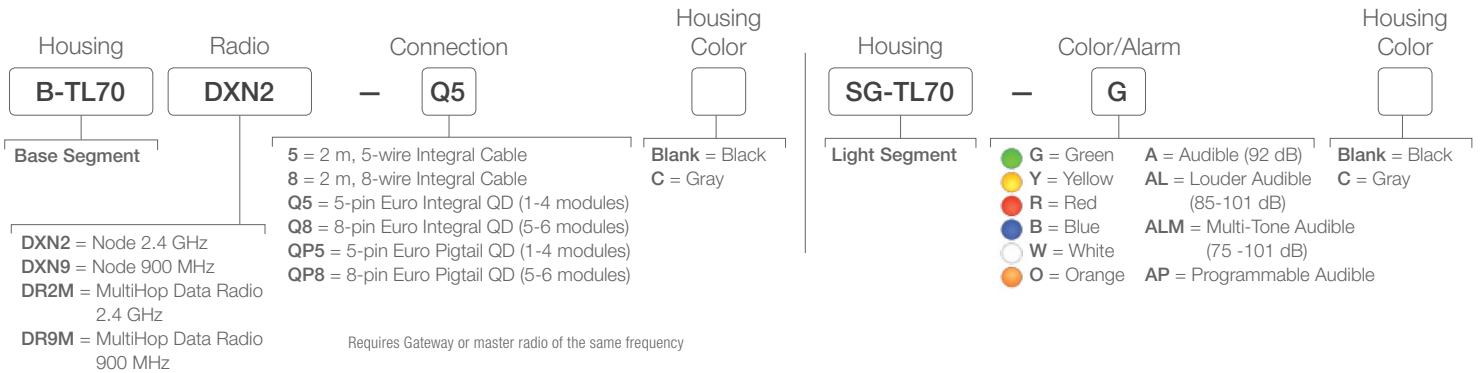

For more specifications see page 417.

Connection options: A model with a QD requires a mating cordset (see page 432).

# Building a Tower Light

[www.bannerengineering.com/towerlights](http://www.bannerengineering.com/towerlights)

Choose Type

1



Standard dc, Wireless, or ac

Audible or No Audible

2



Sealed Omni-Directional Audible

Number of Lighting Segments

3



Position 6 (Light or Audible)

Position 5

Position 4

Position 3

Position 2

Position 1

Base

Connections

4



Integral QD



Euro Pigtail



Integral Cable



Terminal Wired

Housing Color

5





## TL70

Color Count	AC Tower Height (H)	AC Tower Height with Audible (H)	DC Tower Height (H)	DC Tower Height with Audible (H)
1	155.6 mm	212.3 mm	87.6 mm	144.3 mm
2	205.3 mm	262.0 mm	137.3 mm	194.0 mm
3	255.0 mm	311.7 mm	187.0 mm	243.7 mm
4	304.7 mm	361.4 mm	236.7 mm	293.4 mm
5	354.4 mm	411.1 mm	286.4 mm	343.1 mm
6	404.1 mm	NA	336.1 mm	NA

## TL70 Specifications

Supply Voltage and Current	12 to 30 V dc <b>Indicators—Maximum current per LED color:</b> <b>Blue, Green, White:</b> 420 mA at 12 V dc; 145 mA at 30 V dc <b>Red, Yellow, Orange:</b> 285 mA at 12 V dc; 120 mA at 30 V dc <b>Audible:</b> <b>Standard:</b> 30 mA at 12 to 30 V dc <b>Loud:</b> 350 mA at 12 V dc; 110 mA at 30 V dc <b>Multitone:</b> 270 mA at 12 V dc; 110 mA at 30 V dc <b>Programmable:</b> 250 mA at 12 V dc; 110 mA at 30 V dc	100 to 240 V ac; 50/60 Hz <b>Maximum current per color or audible module:</b> 70 mA at 120 V ac and 60 Hz 50 mA at 230 V ac and 50 Hz
Supply Protection Circuitry	Protected against reverse polarity and transient voltages	
Indicator Response Time	<b>DC models:</b> <b>OFF Response:</b> 150 $\mu$ s (maximum) at 12 to 30 V dc <b>ON Response:</b> 180 ms (maximum) at 12 V dc; 50 ms (maximum) at 30 V dc	<b>AC models:</b> <b>OFF Response:</b> 150 $\mu$ s (maximum) at 12 to 30 V dc <b>ON Response:</b> 180 ms (maximum) at 12 V dc; 50 ms (maximum) at 30 V dc
Audible Alarm	2.6 KHz $\pm$ 250 Hz oscillation frequency; maximum intensity 92 dB at 1 m (3.3 ft) (typical)	
Audible Adjustments	Rotate the cover until the desired volume is reached Change in sound intensity from fully open to fully closed is 8 dB	
Radio Range* (Wireless Models)	<b>900 MHz, 1 Watt (Internal antenna):</b> Up to 3.2 km (2 miles) <b>2.4 GHz, 65 mW (Internal antenna):</b> Up to 1000 m (3280 ft) with line of sight	
Minimum Separation Distance (Wireless Models)	<b>900 MHz, 1 Watt:</b> 4.57 m (15 ft) <b>2.4 GHz, 65 mW:</b> 0.3 m (1 ft)	
Construction	<b>Bases, segments and Covers:</b> Polycarbonate	
Environmental Rating	IEC IP65	
Operating Conditions	-40 to +50 °C <b>Relative Humidity:</b> 95% @ 50 °C (non-condensing) <b>Storage Temperature:</b> -40 to +70 °C	
Certifications		

\* Radio range significantly decreases without line of sight. Always verify your wireless network's range by running a site survey.

# TL50 Series

## Tower Lights



- Exceptionally bright with a long, visible indication range
- Install quickly and easily with no assembly required
- Clearly evident on/off status
- Versatile mounting options
- Compact, sleek, rugged design with IP67 models available
- Audible alert: continuous, pulsed and staccato models available
- Models available with IO-Link communication
- Cordsets and brackets see page 432

LASER MARKING AVAILABLE

TL50 Tower Light



For more specifications see page 421.

Connection options: A model with a QD requires a mating cordset (see page 432).

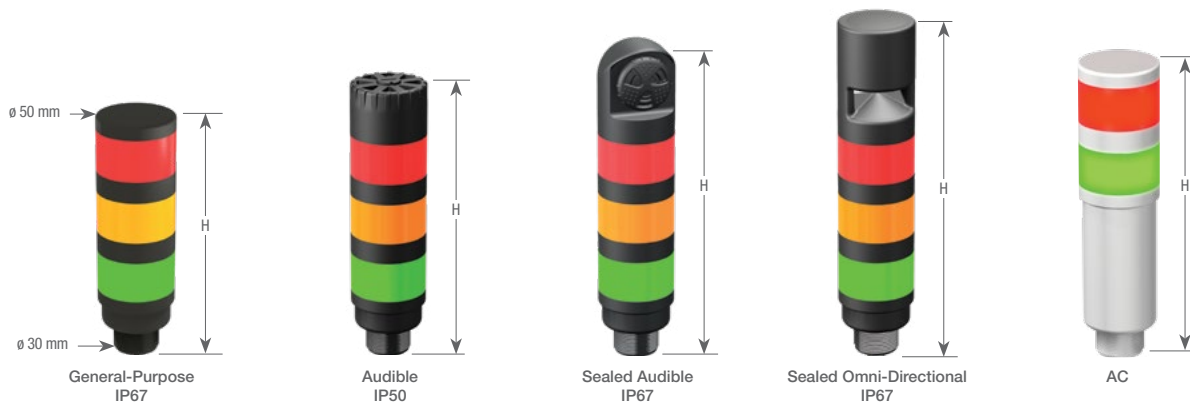

All models available in black or gray

TL50

Color Count	Tower Height (H) General-Purpose IP67	Tower Height (H) Audible† IP50	Tower Height (H) Sealed Audible IP67	Tower Height (H) Sealed Omni-Directional IP67	Tower Height (H) AC
0	—	92.0 mm	74.4 mm	88.4 mm	Add 69 mm to any of these heights to get total height
1	61.2 mm	92.0 mm	115.1 mm	129.1 mm	
2	101.9 mm	132.7 mm	155.8 mm	169.8 mm	
3	142.6 mm	173.4 mm	196.5 mm	210.5 mm	
4	183.3 mm	214.1 mm	237.2 mm	—	
5	224.0 mm	254.8 mm	277.9 mm	291.1 mm	
6	264.7 mm	298.5 mm	318.6 mm	332.6 mm	—
7	305.4 mm	—	—	—	—

† Tower height (H) with top unscrewed approximately 3.5 mm to allow sound to escape.



**Audible**  
max. intensity 92 db  
@ 1 meter (typical)



**Sealed Audible**  
max. intensity 94 db  
@ 1 meter (typical)



**Sealed Omni-Directional Audible**  
max. intensity 99 db  
@ 1 meter (typical)

Sure Cross® Wireless I/O & EZ-LIGHT® Indicators Machine monitoring enables an entirely new category of applications and machine diagnostics free from wired limitation. Contact factory for information.



# Building a Tower Light

[www.bannerengineering.com/towerlights](http://www.bannerengineering.com/towerlights)

Choose Type

1



Standard  
High Intensity  
Daylight Visible  
Standard with IO-Link

Audible or No Audible

2



**Audible**  
max. intensity 92 db  
@ 1 meter (typical)



**Sealed Audible**  
max. intensity 94 db  
@ 1 meter (typical)



**Sealed Omni-Directional Audible**  
max. intensity 99 db  
@ 1 meter (typical)

Lighting Options/  
Function

3



Position 7 (not available with audible)

Position 6

Position 5

Position 4

Position 3

Position 2

Position 1

Base



Color availability varies between models

Connections

4



Integral QD



Euro Pigtail



Integral Cable

Housing Color

5



## TL50 Specifications

Supply Voltage and Current	<p><b>DC models:</b> 18 to 30 V dc (10% max. ripple); or 21 to 27 V ac</p> <p><b>Standard Brightness:</b> Indicators: 45 mA max. current per LED color Standard Audible Alarm (IP50): @ 25 mA max. current Sealed Audible Alarm (IP67): 35 mA max. current Omni-Directional Sealed Audible Alarm: 45 mA max. current</p> <p><b>High Brightness: max. current per LED color:</b> Indicators: 18 V dc—100 mA; 30 V dc—60 mA; 21 V ac—80 mA; 27 V ac—70 mA Standard Audible (IP50): 25 mA max. current Sealed Audible Alarm (IP67): 35 mA max. current</p> <p><b>Audible only:</b> @ 45mA max.</p> <p><b>AC models:</b> 100 to 240 V ac; 50 or 60 Hz</p>
Indicators	LEDs are independently selected— Green, Yellow, Red, Blue, White, Turquoise, Orange, Violet, Sky Blue or Magenta; 1-7 colors depending on model
Supply Protection Circuitry	Protected against reverse polarity and transient voltages
Input Response Time	<p><b>Indicators ON/OFF (dc):</b> 10 milliseconds (max.) <b>Indicators ON/OFF (ac):</b> 500 milliseconds (max.)</p>
Audible Alarm	<p>Audible measurements are made in the direction sound exits the device. For standard audible models, this is the top of the unit (when mounted vertically, sound is directed toward the ceiling). For sealed audible models (IP67), sound exits the vented openings in the side of the unit, which should be oriented so that the sound is directed toward the machine operator(s). In environments with high ambient noise levels or high ceilings that absorb sound, the sealed version is recommended.</p> <p><b>Standard Audible Alarm:</b> 2.7 KHz ± 500 Hz oscillation frequency; max. intensity 92 db @ 1 meter (typical) <b>Sealed Audible Alarm:</b> 29 KHz to 250 Hz oscillation frequency; max. intensity 94 db @ 1 meter (typical) <b>Omni-Directional Sealed Audible Alarm with Intensity Adjustment:</b> 2.1 KHz ± 250 Hz oscillation frequency; max intensity 95 dB at 1 meter (3.3 ft) (typical)</p>
Audible Adjustments	<p><b>Standard Audible Alarm:</b> Unscrew the cover (up to 1.5 turns max.) to adjust the audible intensity. (Do not exceed 1.5 turns or the cover may detach during operation.) For max. intensity, rotate the center plug 180° counterclockwise to remove it. <b>Sealed Audible Alarm and Omni-Directional Sealed Audible Alarm with Intensity Adjustment:</b> Rotate the front cover until the desired intensity is reached.</p>
Construction	<p><b>Bases and Covers:</b> ABS      <b>Light Segment:</b> Polycarbonate</p>
Environmental Rating	<p><b>General-Purpose:</b> IEC IP67      <b>Audible:</b> IEC IP50 or IEC IP67, depending on model</p>
Operating Conditions	<p><b>General-Purpose:</b> -40 to +50 °C <b>Audible:</b> -20 to +50 °C <b>Relative Humidity:</b> 95% @ 50 °C (non-condensing) <b>Storage Temperature:</b> -40 to +70 °C</p>
Certifications	

# TL50C Series

## Compact Tower Lights

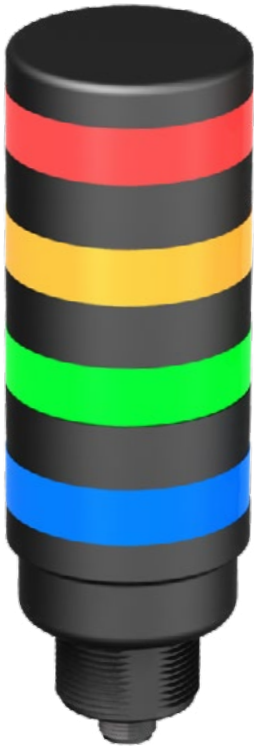

- Displays up to seven colors in one tower
- Half the height of standard TL50 models
- Bright, uniform lighted segments with 10 color choices available
- Available with standard, sealed or Omni-Directional audible
- Compact, sleek, rugged design with IP67 models available
- DC models work down to 12 volts, allowing for use in battery-powered mobile equipment
- Audible alert: continuous, pulsed and staccato models available
- Cordsets and brackets see page 432

LASER MARKING AVAILABLE

TL50C Compact Tower Light

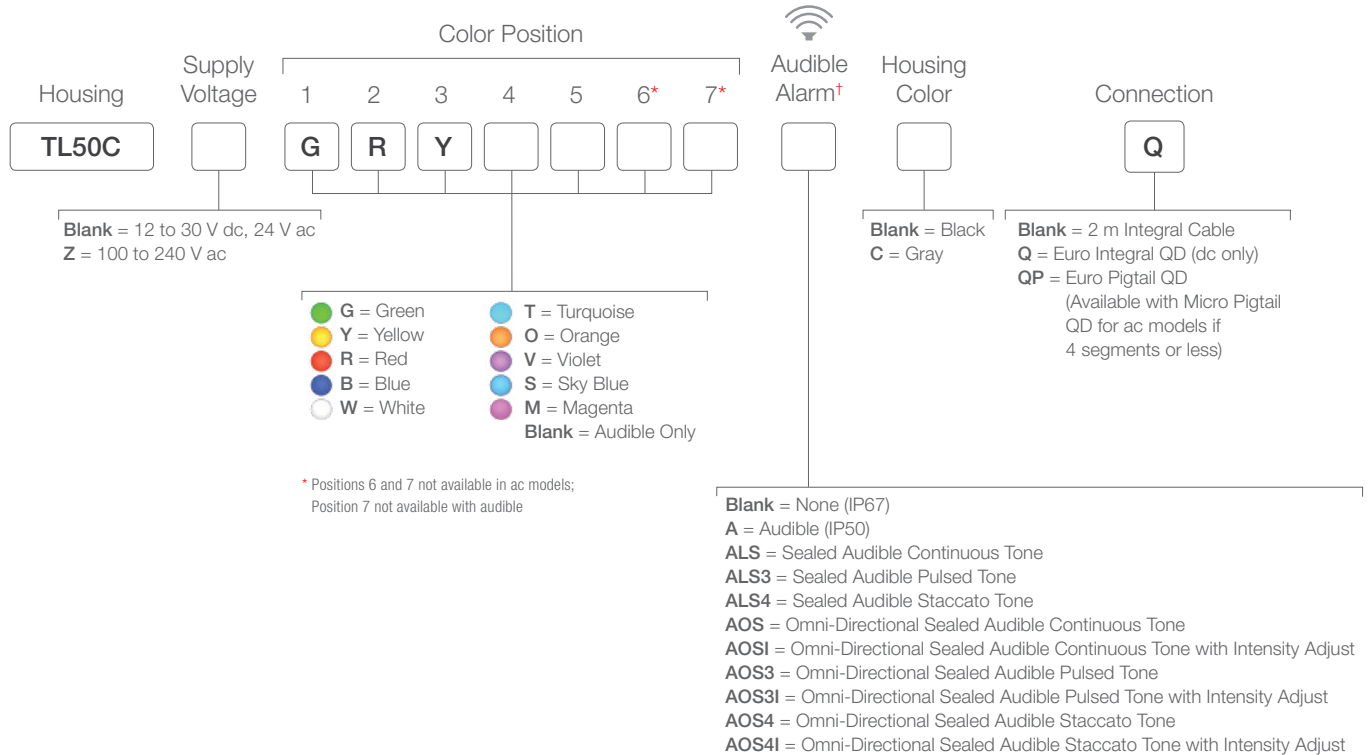

For more specifications see page 425.

Connection options: A model with a QD requires a mating cordset (see page 432).



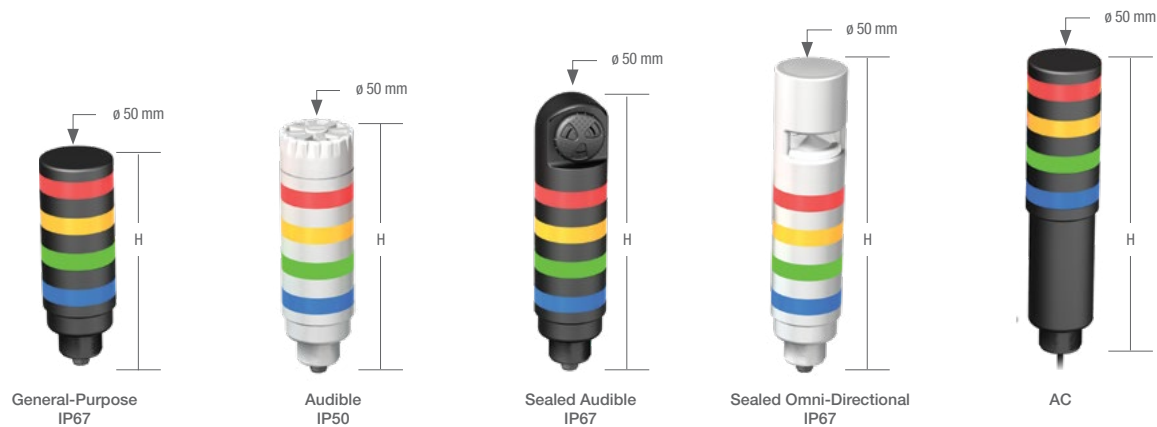

All models available in black or gray

TL50C

Color Count	Tower Height (H) General-Purpose IP67	Tower Height (H) Audible† IP50	Tower Height (H) Sealed Audible IP67	Tower Height (H) Sealed Omni-Directional IP67	Tower Height (H) AC
1	46.2 mm	77.1 mm	100.2 mm	114.2 mm	Add 69 mm to any of these heights to get total height
2	72.0 mm	102.9 mm	126.0 mm	140.0 mm	
3	97.8 mm	128.7 mm	151.8 mm	165.8 mm	
4	123.6 mm	154.5 mm	177.6 mm	191.6 mm	
5	149.4 mm	180.3 mm	203.4 mm	217.4 mm	
6	175.2 mm	206.1 mm	229.2 mm	243.4 mm	—
7	201.0 mm	—	—	—	—

† Tower height (H) with top unscrewed approximately 3.5 mm to allow sound to escape.

Audible Types



**Audible**  
max. intensity 92 db  
@ 1 meter (typical)



**Sealed Audible**  
max. intensity 94 db  
@ 1 meter (typical)



**Sealed Omni-Directional Audible**  
max. intensity 99 db  
@ 1 meter (typical)

# Building a Tower Light

www.bannerengineering.com/towerlights

Choose Type

1



Compact

Audible or No Audible

2



**Audible**  
max. intensity  
92 db @ 1 meter  
(typical)



**Sealed Audible**  
max. intensity 94 db  
@ 1 meter (typical)



**Sealed Omni-Directional Audible**  
max. intensity 99 db  
@ 1 meter (typical)

Lighting Options/  
Function

3



Position 7 (not available with audible)

Position 6

Position 5

Position 4

Position 3

Position 2

Position 1

Base



Color availability varies between models

Connections

4



Integral QD



Euro Pigtail





Integral Cable

Housing Color

5



## TL50C Specifications

Supply Voltage and Current	<p><b>DC models:</b> 12 to 30 V dc; or 21 to 27 V ac</p> <p><b>Indicators: Max. current per LED color:</b> at 12 V: 135 mA at 24 V: 55 mA at 30 V: 45 mA</p> <p><b>Standard Audible Alarm:</b> 25 mA max. current <b>Sealed Audible Alarm:</b> 35 mA max. current <b>Omni-Directional Sealed Audible Alarm:</b> 45 mA max. current</p>
Indicators	LEDs are independently selected, 1 to 7 colors depending on model
Supply Protection Circuitry	Protected against reverse polarity and transient voltages
Input Response Time	<p><b>Indicators ON/OFF (dc):</b> 10 milliseconds (max.) <b>Indicators ON/OFF (ac):</b> 500 milliseconds (max.)</p>
Audible Adjustments	<p><b>Standard Audible Alarm:</b> Unscrew the cover (up to 1.5 turns max.) to adjust the audible intensity. (Do not exceed 1.5 turns or the cover may detach during operation.) For max. intensity, rotate the center plug 180° counterclockwise to remove it.</p> <p><b>Sealed Audible Alarm and Omni-Directional Sealed Audible Alarm with Intensity Adjustment:</b> Rotate the front cover until the desired intensity is reached.</p> <p><b>Omni-Directional Sealed Audible Alarm:</b> No adjustment</p>
Construction	<b>Bases and Covers:</b> ABS <b>Light Segment:</b> Polycarbonate
Environmental Rating	<p><b>Non-Audible and Sealed Audible:</b> IEC IP67 <b>Standard Audible:</b> IEC IP50</p>
Operating Conditions	<p><b>General-Purpose:</b> -40 to +50 °C <b>Audible:</b> -20 to +50 °C <b>Relative Humidity:</b> 95% @ 50 °C (non-condensing) <b>Storage Temperature:</b> -40 to +70 °C</p>
Certifications	 

# TL50BL Series

## Beacon Tower Lights



- Highly visible indication for indoor or outdoor applications
- Compact, stylish design with rotating and flashing options
- Audible alert: continuous, pulsed and staccato models available
- Omni-Directional audible models provide clear annunciation in the noisiest environments
- Models available with rugged, water-resistant IP67 housing
- Cordsets and brackets see page 432

TL50BL Beacon Tower Light

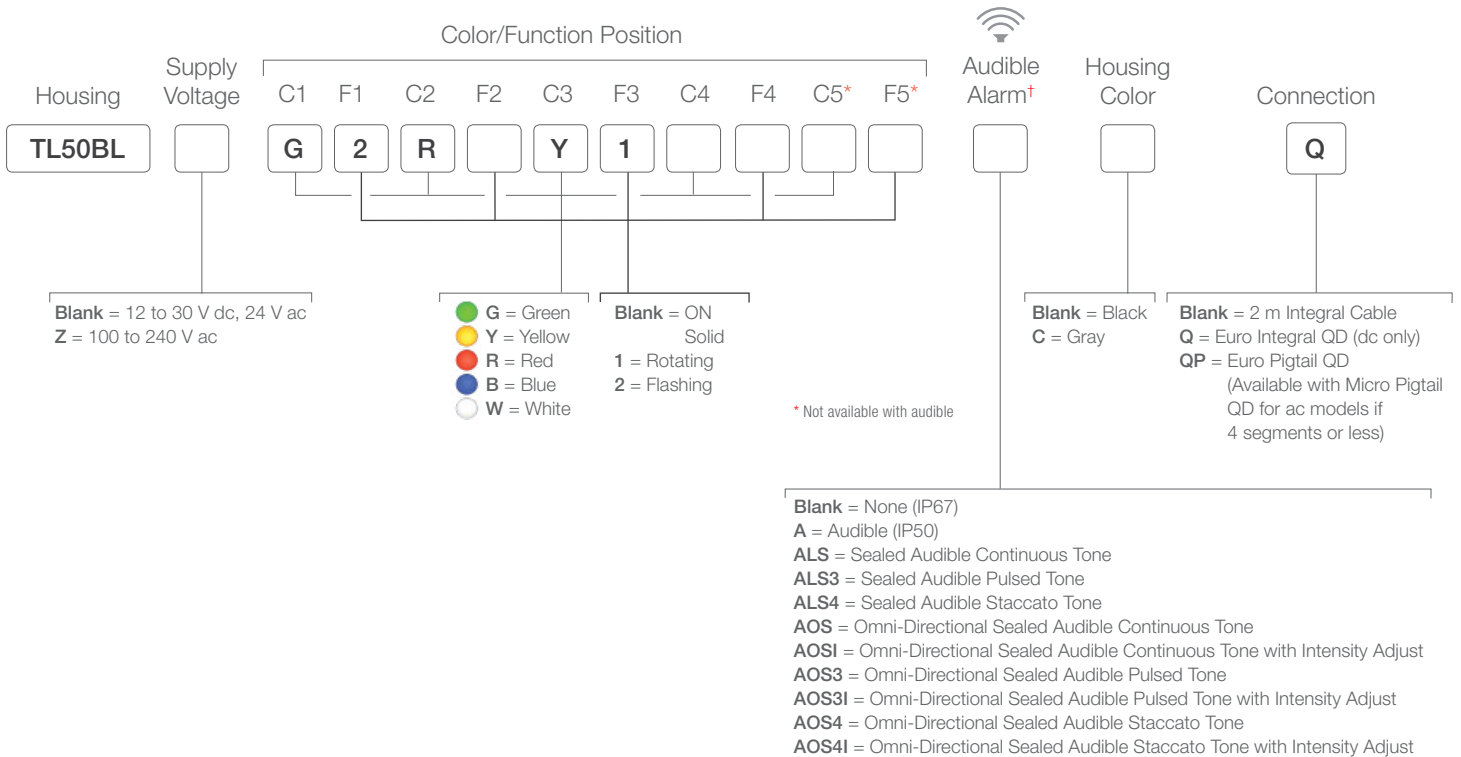

For more specifications see page 430.

Connection options: A model with a QD requires a mating cordset (see page 432).

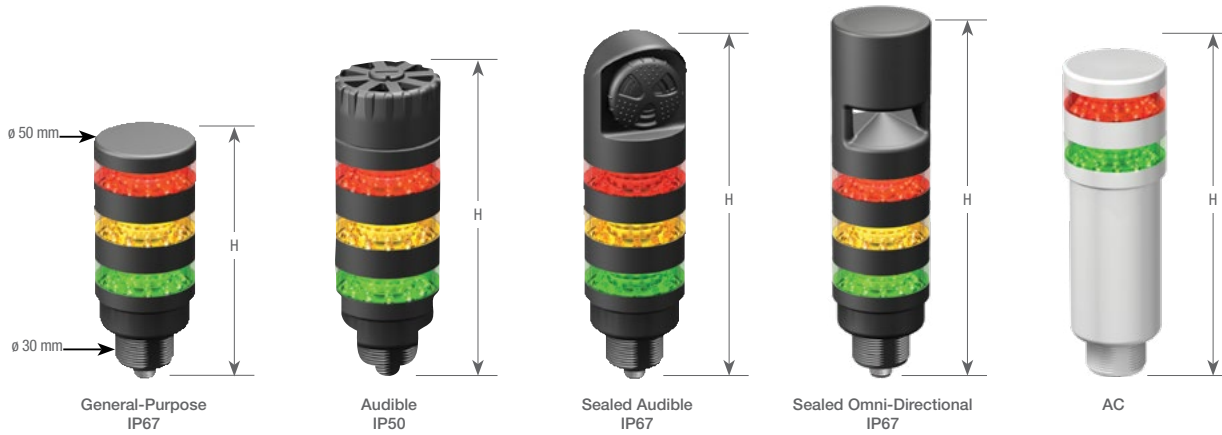

All models available in black or gray

## TL50BL

Color Count	Tower Height (H) General-Purpose IP67	Tower Height (H) Audible <sup>†</sup> IP50	Tower Height (H) Sealed Audible IP67	Tower Height (H) Sealed Omni-Directional IP67	Tower Height (H) AC
1	46.2 mm	77.1 mm	100.2 mm	129.1 mm	Add 69 mm to any of these heights to get total height
2	72.0 mm	102.9 mm	126.0 mm	169.8 mm	
3	97.8 mm	128.7 mm	151.8 mm	210.5 mm	
4	123.6 mm	154.5 mm	177.6 mm	—	
5	149.4 mm	—	—	—	

<sup>†</sup> Tower height (H) with top unscrewed approximately 3.5 mm to allow sound to escape.

## Audible Types



**Audible**  
max. intensity 92 db  
@ 1 meter (typical)



**Sealed Audible**  
max. intensity 94 db  
@ 1 meter (typical)



**Sealed Omni-Directional Audible**  
max. intensity 99 db  
@ 1 meter (typical)

# Building a Tower Light

[www.bannerengineering.com/towerlights](http://www.bannerengineering.com/towerlights)

Choose Type

1



Daylight Visible

Audible or No Audible

2



**Audible**  
max. intensity 92 db @ 1 meter (typical)



**Sealed Audible**  
max. intensity 94 db @ 1 meter (typical)



**Sealed Omni-Directional Audible**  
max. intensity 99 db @ 1 meter (typical)

Lighting Options/Function

3



Position 5 (not available with audible)

Position 4

Position 3

Position 2

Position 1

Base



Connections

4



Integral QD



Euro Pigtail



Integral Cable

Housing Color

5



## TL50 Beacon Specifications

Supply Voltage and Current	<p><b>DC models:</b> 12 to 30 V dc (10% max. ripple); or 21 to 27 V ac</p> <p><b>Indicators — max. current per LED color:</b></p> <ul style="list-style-type: none"> <li>@ 12 V dc: 125 mA</li> <li>@ 30 V dc: 60 mA</li> <li>@ 21 V ac: 80 mA</li> <li>@ 27 V ac: 70 mA</li> </ul> <p><b>Standard Audible Alarm:</b> 25 mA max. current  <b>Sealed Audible Alarm:</b> 35 mA max. current  <b>AC models:</b> 100 to 240 V ac</p>
Indicators	1-5 colors depending on model; Green, Red, Yellow, Blue and White LEDs are independently selected
Supply Protection Circuitry	Protected against reverse polarity and transient voltages
Input Response Time	<p><b>Indicators ON/OFF (dc):</b> 1 milliseconds (max.)  <b>Indicators ON/OFF (ac):</b> 500 milliseconds (max.)</p>
Audible Alarm	<p>Audible measurements are made in the direction sound exits the device. For standard audible models, this is the top of the unit (when mounted vertically, sound is directed toward the ceiling). For sealed audible models, sound exits the vented openings in the side of the unit, which should be oriented so that the sound is directed toward the machine operator(s). In environments with high ambient noise levels or high ceilings that absorb sound, the sealed version is recommended.</p> <p><b>Standard Audible Alarm:</b> 2.7 KHz <math>\pm</math> 500 Hz oscillation frequency; max. intensity 92 db @ 1 meter (typical)  <b>Sealed Audible Alarm:</b> 2.9 KHz <math>\pm</math> 250 Hz oscillation frequency; max. intensity 94 db @ 1 meter (typical)</p>
Audible Adjustments	<p><b>Standard Audible Alarm:</b> Unscrew the cover (up to 1.5 turns max.) to adjust the audible intensity. (Do not exceed 1.5 turns or the cover may detach during operation.) For max. intensity, rotate the center plug 180° counterclockwise to remove it.</p> <p><b>Sealed Audible Alarm and Omni-Directional Sealed Audible Alarm with Intensity Adjustment:</b> Rotate the front cover until the desired intensity is reached.</p>
Construction	<p><b>Bases and Covers:</b> ABS  <b>Light Segment:</b> Polycarbonate</p>
Environmental Rating	<p><b>Standard Audible:</b> IEC IP50  <b>Non Audible and Sealed Audible:</b> IEC IP67</p>
Operating Conditions	<p><b>Temperature:</b></p> <ul style="list-style-type: none"> <li><b>General-Purpose:</b> -40 to +50 °C</li> <li><b>Standard and Sealed Audible:</b> -20 to +50 °C</li> </ul> <p><b>Max. Rel. Humidity:</b> 95% @ 50 °C (non-condensing)  <b>Storage Temperature:</b> -40 to +70 °C</p>
Certifications	

# CL50 Series

## Column Lights



- Up to three colors in one device for multiple status indication
- Ideal for machine process status indication and visual guidance
- Install quickly and easily, no tools required
- Large surface area can be easily seen from long distances
- Audible models available with standard or sealed audible element
- Cordsets and brackets see page 432

LASER MARKING AVAILABLE

### CL50 Column Light

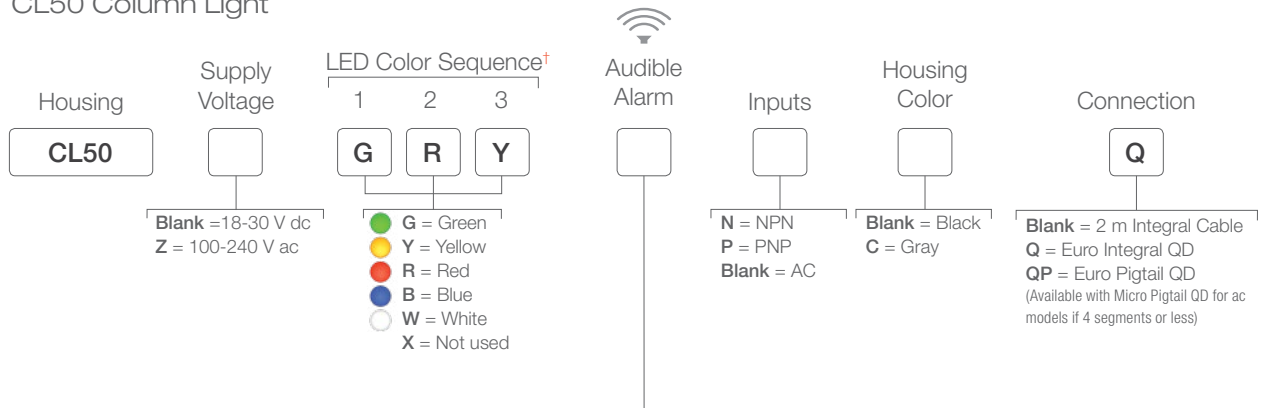

**Audible**  
max. intensity 92 db @ 1 meter (typical)



**Sealed Audible**  
max. intensity 94 db @ 1 meter (typical)



**Sealed Omni-Directional Audible**  
max. intensity 99 db @ 1 meter (typical)

- Blank = None (IP67)
- A = Audible (IP50)
- ALS = Sealed Audible Continuous Tone
- ALS3 = Sealed Audible Pulsed Tone
- ALS4 = Sealed Audible Staccato Tone
- AOS = Omni-Directional Sealed Audible Continuous Tone
- AOSI = Omni-Directional Sealed Audible Continuous Tone with Intensity Adjust
- AOS3 = Omni-Directional Sealed Audible Pulsed Tone
- AOS3I = Omni-Directional Sealed Audible Pulsed Tone with Intensity Adjust
- AOS4 = Omni-Directional Sealed Audible Staccato Tone
- AOS4I = Omni-Directional Sealed Audible Staccato Tone with Intensity Adjust



Connection options: A model with a QD requires a mating cordset (see page 432).  
† Contact factory for other colors and color combinations





All models available in black or gray

## CL50 Specifications

Supply Voltage and Current	18 to 30 V dc (10% max. ripple) 100 mA max. current @ 18 V dc; 70 mA max. current @ 30 V dc <b>Standard Audible Alarm:</b> 25 mA max. current <b>Sealed Audible Alarm:</b> 35 mA max. current <b>Omni-Directional Sealed Audible Alarm:</b> 45 mA max. current <b>AC models:</b> 100 to 240 V ac
Indicators	Green, Red, Yellow, Blue and White; 1-3 colors, depending on model LEDs or audible alarm are independently selected
Supply Protection Circuitry	Protected against reverse polarity and transient voltage
Input Response Time	<b>Indicators ON/OFF (dc):</b> 10 milliseconds (max.) <b>Indicators ON/OFF (ac):</b> 500 milliseconds (max.)
Audible Alarm	<b>Standard Audible Alarm:</b> 2.7 KHz $\pm$ 500 Hz oscillation frequency; max. intensity 92 db @ 1 meter (typical) <b>Sealed Audible Alarm:</b> 2.9 KHz $\pm$ 250 Hz oscillation frequency; max. intensity 94 db @ 1 meter (typical)
Audible Adjustments	<b>Standard Audible Alarm:</b> Unscrew the cover (up to 1.5 turns max.) to adjust the audible intensity. (Do not exceed 1.5 turns or the cover may detach during operation.) For max. intensity, rotate the center plug 180° counterclockwise to remove it. <b>Sealed Audible Alarm:</b> Rotate the front cover until the desired intensity is reached. <b>Omni-Directional Sealed Audible Alarm:</b> No adjustment
Construction	<b>Bases and Covers:</b> ABS <b>Light Segment:</b> Polycarbonate
Environmental Rating	<b>Standard Audible:</b> IEC IP50 <b>General-Purpose and Sealed Audible:</b> IEC IP67
Connections	Integral 4-pin or 5-pin M12/Euro-style QD, 150 mm PVC pigtail with QD, or 2 m (6.5') integral cable, 4-pin or 5-pin Micro-style QD pigtail, depending on model
Operating Conditions	<b>Temperature:</b> <b>Standard and Sealed Audible:</b> -20 to +50 °C <b>General-Purpose:</b> -40 to +50 °C <b>Relative humidity:</b> 95% @ 50 °C (non-condensing) <b>Storage Temperature:</b> -40 to +70 °C
Vibration and Mechanical Shock	All models meet Mil. Std. 202F requirements method 201A (vibration: 10 to 60 Hz max., double amplitude 0.06", maximum acceleration 10G). Also meets IEC 947-5-2; 30G 11 ms duration, half sine wave.
Certifications	 



**Euro-Style**  
Straight connector models listed; for right-angle, add **RA** to the end of the model number (example, **MQDC-406RA**)

3 Lights/4-Pin	4 Lights/5-Pin	5+ Lights/8-Pin
<b>MQDC-406</b> 2 m (6.5')	<b>MQDC1-506</b> 2 m (6.5')	<b>MQDC2S-806</b> 2 m (6.5')
<b>MQDC-415</b> 5 m (15')	<b>MQDC1-515</b> 5 m (15')	<b>MQDC2S-815</b> 5 m (15')
<b>MQDC-430</b> 9 m (30')	<b>MQDC1-530</b> 9 m (30')	<b>MQDC2S-830</b> 9 m (30')



**Micro-Style**  
For AC models

3-Lights/4-Pins	4 Lights/5-Pin
<b>MQAC2-406</b> 2 m (6.5')	<b>MQAC2-506</b> 2 m (6.5')
<b>MQAC2-415</b> 4 m (12')	<b>MQAC2-515</b> 4 m (12')
<b>MQAC2-430</b> 9 m (30')	<b>MQAC2-530</b> 9 m (30')

Additional cordset information is available  
See page 758



SMB30A



SMB30MM



SMBAMS30P



SMB30RAVK

Additional bracket information is available  
See page 727



**Laser Marking**

Light sections can be permanently marked with custom text or images (all models except TL50BL Beacon)

**Flush Foldable Bracket**

for use with elevated mount systems



SA-FFB12 Black  
SA-FFB12C Gray

To change position



1. Remove screws & pull out



2. Adjust angle



3. Push in & replace screws





4. Complete

Elevated Mount System



Features	Model			Components	
<ul style="list-style-type: none"> <li>Streamlined black acetal or white UHMW stand-off pipe adapter/cover</li> <li>Connects to 30 mm light base</li> <li>Mounting hardware included</li> </ul>	use with TL50 and CL50 models	<b>SA-M30TE12</b> (black ABS)	<b>SA-M30TE12C</b> (whiteTL50 ABS)		
	Use with TL70 Models	<b>SA-M30</b> (black ABS)	<b>SA-M30C</b> (white ABS)		
<ul style="list-style-type: none"> <li>Elevated-use stand-off pipe (1/2 in. NPSM/DN15)</li> <li>Polished 304 stainless steel, black anodized aluminum, or clear anodized aluminum surface</li> <li>1/2 in. NPT thread at both ends</li> <li>Compatible with most industrial environments</li> </ul>	<b>Polished 304 Stainless Steel</b>	<b>Black Anodized Aluminum</b>	<b>Clear Anodized Aluminum</b>		
	<b>SOP-E12-150SS</b> 150 mm (6") long	<b>SOP-E12-150A</b> 150 mm (6") long	<b>SOP-E12-150AC</b> 150 mm (6") long		
	<b>SOP-E12-300SS</b> 300 mm (12") long	<b>SOP-E12-300A</b> 300 mm (12") long	<b>SOP-E12-300AC</b> 300 mm (12") long		
	<b>SOP-E12-900SS</b> 900 mm (36") long	<b>SOP-E12-900A</b> 900 mm (36") long	<b>SOP-E12-900AC</b> 900 mm (36") long		
<ul style="list-style-type: none"> <li>Streamlined black acetal or white UHMW mounting base adapter/cover</li> <li>Connects between 1/2 in. NPSM/DN15 pipe and 30 mm (1-3/16 in) drilled hole</li> <li>Mounting hardware included</li> </ul>		<b>SA-E12M30</b> (black zinc and ABS)			
		<b>SA-E12M30C</b> (white zinc and ABS)			



EZ-LIGHT® Controllers

Description	Function	Model	
5 toggle switches	ON-OFF-FLASH	LC80T	

12 position rotary switch	ON-OFF-FLASH	LC80R	
---------------------------	--------------	-------	---

EZ-LIGHT® Sealed Right-Angle Brackets

Description	Model		
Bracket kit with base, 1/2-14 pipe adapter, set screw, fasteners, o-rings and gaskets. For use with stand-off pipe (listed and sold separately).	LMBE12RA		
	LMBE12RAC		

Bracket kit with base, 30 mm adapter, set screw, fasteners, o-rings and gaskets	LMB30RA		
	LMB30RAC		



## Indicators

Banner's Indicators offer a wide variety of bright, highly visible models ranging from daylight visible to multiple colors in one device. Indicators have a rugged design for long-term use and require no additional protective box. Flexibility in design, size and mounting provides a unique solution for many indication applications.

# INDICATORS

---

BASE MOUNT

**page 436**

BARREL/T-STYLE MOUNT

**page 448**

FLAT MOUNT







**page 456**



---

## Base-Mount Indicators

Base-mount indicators provide a wide variety of indicators for general purpose indication applications. They have a sleek design, audible or daylight visible options available, and most appear gray when off for clear indication of on/off status.

Series	Description	Number of Colors	Brightness	Dimensions	Power Supply	Communication
	<b>K30L</b> These small dome indicators have long-life LEDs for zero maintenance after installation. page 438	<b>K30L:</b> 1 to 3 9 color options <b>K30L2:</b> 7 color options	Standard	<b>Base:</b> 22 mm <b>Dome:</b> 30 mm	10 to 30 V dc	NA
	<b>K50L</b> These indicators are completely epoxy encapsulated, which protects the electronics from the harshest environments. page 439	<b>K50L:</b> 1 to 3 9 color options <b>K50L2:</b> 7 color options	Standard	<b>Base:</b> 30 mm <b>Dome:</b> 50 mm	18 to 30 V dc, 85 to 130 V ac	I/O Link Option ModBus Option
	<b>K70L</b> Bright, uniform indicators in a rugged, water-resistant housing. page 442	1 to 5 (5 color options)	Standard	<b>Base:</b> 30 mm <b>Dome:</b> 70 mm	12 to 30 V dc	Wireless Option
	<b>K90L</b> These indicators are rugged, 90 mm indicator lights that provide extremely bright and uniform illumination. page 443	1 to 5 (5 color options)	High-Brightness	<b>Base:</b> 30 mm <b>Dome:</b> 90 mm	12 to 30 V dc	NA
	<b>K50BL Beacon</b> Extremely bright and ideal for indoor and outdoor areas with high levels of ambient light. page 444	1 or 2 (5 color options)	Day Light Visible	<b>Base:</b> 30 mm	12 to 30 V dc, 85 to 250 V ac	ModBus Option
	<b>K50LD Daylight</b> Features a brightly illuminated base for enhanced visual indication. page 445	<b>AC:</b> 1 <b>DC:</b> 1 or 3 (5 color options)	Day Light Visible	<b>Base:</b> 30 mm	15 to 30 V dc, 85 to 130 V ac	ModBus Option
	<b>K50L &amp; K30L Hazardous Area</b> Indicator Lights for hazardous areas are safe to use in every classified zone or area with extensive intrinsically safe approvals. page 446	1 to 3 (5 color options)	Standard	<b>K50</b> <b>Base:</b> 30 mm <b>Dome:</b> 50 mm <b>K30</b> <b>Base:</b> 22 mm <b>Dome:</b> 30 mm	10 to 30 V dc	NA

## OTHER AVAILABLE MODELS



Barrel/T-Style Mount

448



Flat Mount

456

# K30L2 Series

## Domed Indicator



- Bright 30 mm diameter polycarbonate dome gives uniform illumination from all directions
- Seven colors in one device (green, red, yellow, cyan, blue, magenta, white)
- Neutral color when in the OFF condition eliminates false indication from surrounding ambient light
- Rugged IP66, IP67, IP69K and UL Type 4x, 13 design
- Models available in FDA grade materials (not Type 13)
- Bimodal inputs (PNP or NPN)
- Cordsets and brackets available see page 447

LASER MARKING AVAILABLE

### K30L2

Example Model Number: K30L2RGB7Q

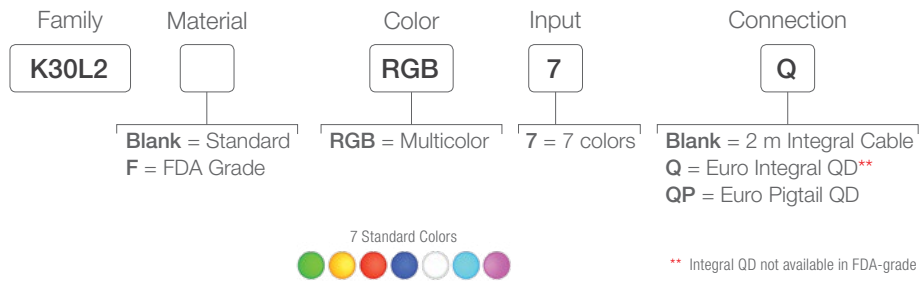

\*\* Integral QD not available in FDA-grade material



K30L Models

For more specifications see page 445.

Connection Option: A model with a QD requires a mating cordset (see page 447).



# K50L2 Series

## Domed Indicator



- Bright 50 mm diameter polycarbonate dome gives uniform illumination from all directions
- Seven colors in one device (green, yellow, red, blue, white, cyan, magenta)
- Neutral color when in the OFF condition eliminates false indication from surrounding ambient light
- Rugged IP66, IP67, IP69K and UL Type 4x, 13 design
- Models available in FDA grade materials (not Type 13)
- Bimodal inputs (PNP or NPN)
- Models with integrated alarm available
- Cordsets and brackets available see page 447

LASER  
MARKING  
AVAILABLE

### K50L2

Example Model Number: K50L2RGB7A1Q

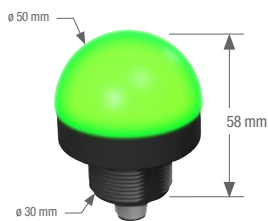
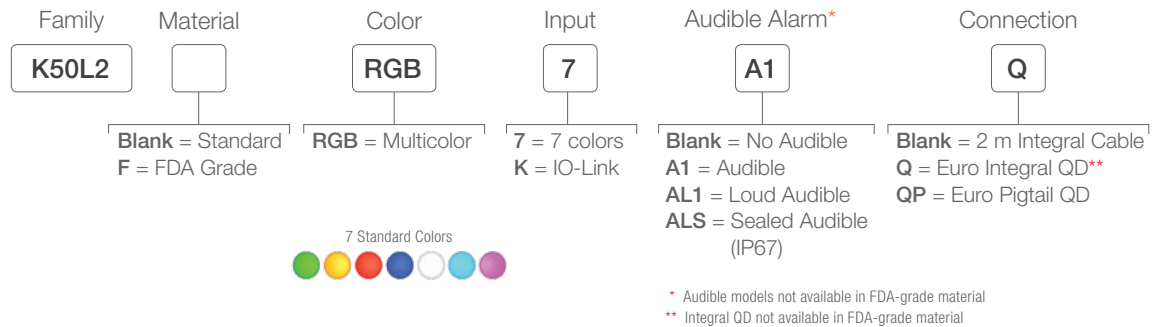

K50L2 Models

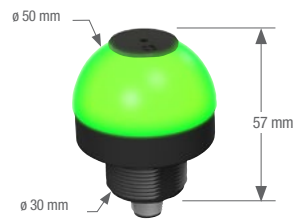

K50L2 Audible Models  
(A1, AL1)

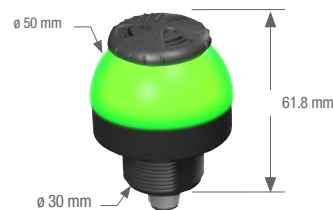

K50L2 Adjustable Audible Models  
(ALS)

For more specifications see page 445.

 Connection Option: A model with a QD requires a mating cordset (see page 447).

# K30L and K50L Series

## Domed Indicator



- Smooth 30 or 50 mm diameter dome gives uniform illumination from all directions.
- The neutral color when in the OFF condition eliminates false indication from surrounding ambient light
- Up to three colors in one device with many different color combinations
- Modbus option as well as NPN, PNP
- Long-lasting, energy-efficient LEDs for years of operation with zero maintenance
- Many models rated to IP69K to handle high-pressure washdown environments
- Multifunction models available; contact factory
- Cordsets and brackets available see page 447

### K30L (10-30 V dc) and K50L (18-30V dc) One-, Two-, or Three-Color

Example Model Number: K50LGRYPQ

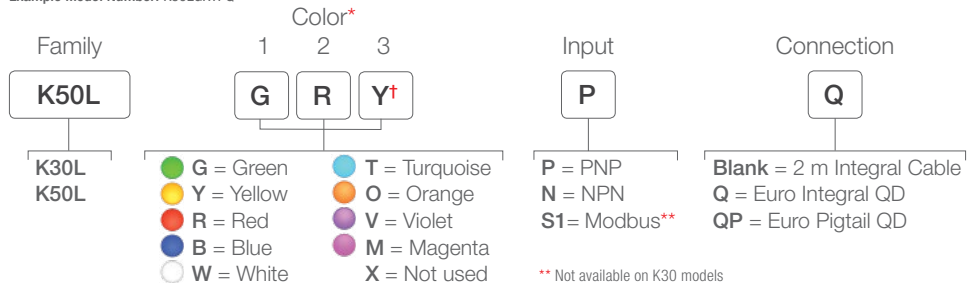

### K50L ( 85-130 V ac) One-, Two-, or Three-Color

Example Model Number: K50LGRYA120Q

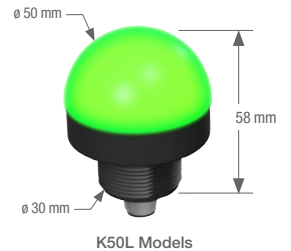
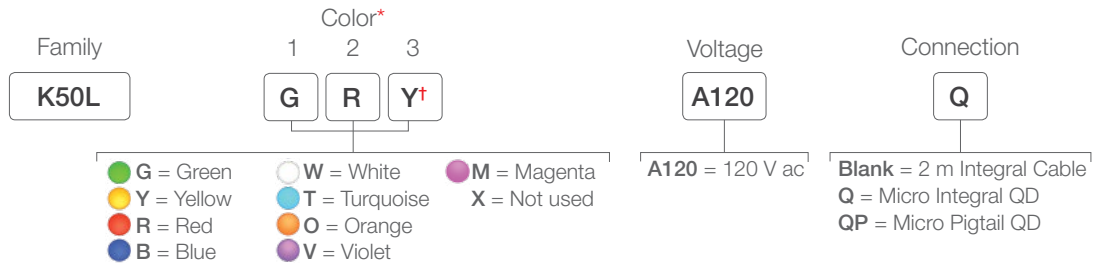

For more specifications see page 445.

 Connection Option: A model with a QD requires a mating cordset (see page 447).

\* Single-color models are available. Colors are independently selectable. Contact factory for other colors and color combinations.

† Add 7 after last color option for Sensor Emulators (example, K30LGYX7PQ). Use with discrete output of photoelectric and proximity sensors to duplicate the sensor's Green and Yellow indicator function. When the sensor is powered, the Green LED is ON. When the sensor's output is energized, the Yellow LED is ON.

# K50L Audible Series

## Audible Domed Indicator



- 50 mm diameter dome gives uniform illumination from all directions and an audible alarm with several tones and intensity levels
- Completely epoxy encapsulated, protecting the electronics from the harshest environments, making them nearly indestructible.
- The neutral color when in the OFF condition eliminates false indication from surrounding ambient light
- Up to three colors in one device with many different color combinations
- Long-lasting, energy-efficient LEDs for years of operation with zero maintenance
- Many models rated to IP69K to handle high-pressure washdown environments
- Cordsets and brackets available see page 447

### K50L One-, Two-, or Three-Color Audible

Example Model Number: K50LGRALSYDQ

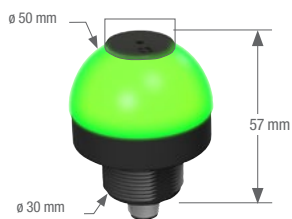
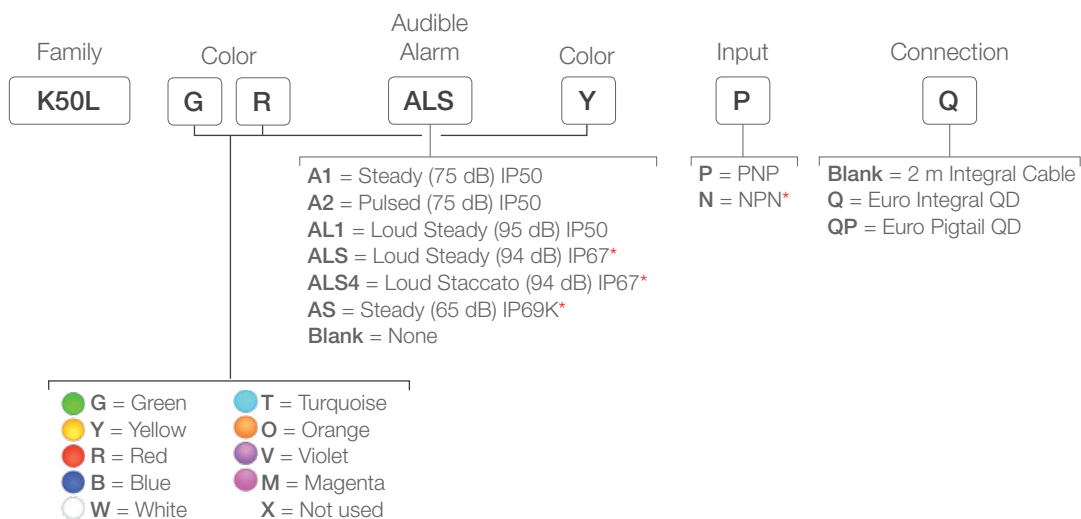

K50L Audible Models  
(A1, A2, AL1)

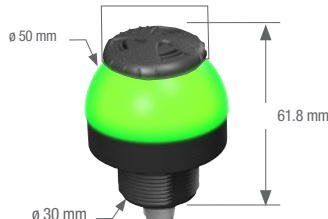

K50L Adjustable Audible Models  
(ALS, ALS4)

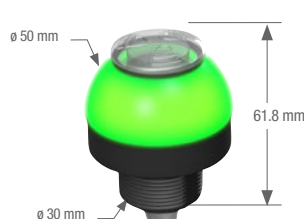

K50L Sealed Audible Models  
(AS)

For more specifications see page 446.

 Connection Option: A model with a QD requires a mating cordset (see page 447).

\* NPN not available on these models

# K70L Series

## Medium-Sized Domed Indicator



- Bright, uniform indicator light
- All models have flashing input control
- Models are available with up to five colors in one device
- Rugged, water-resistant IP65-rated design
- 12 V to 30 V dc operations
- Wireless options available in either 900 MHz and 2.4 GHz ISM Bands
- Cordsets and brackets available see page 447

LASER MARKING AVAILABLE

### K70 Standard and Wireless

Example Model Number: K70LWBGYRPQ

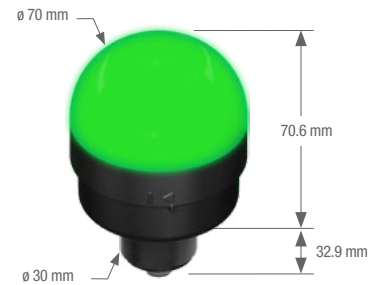
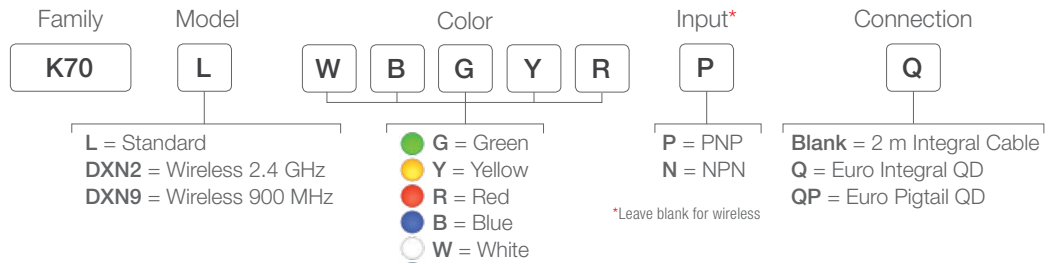

For more specifications see page 445.

 Connection Option: A model with a QD requires a mating cordset (see page 447).

# K90L and K90TL Series

## Large Domed Indicator

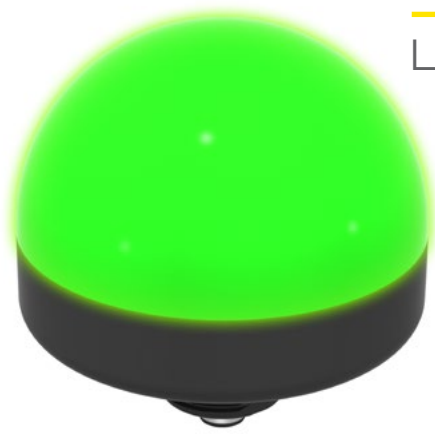

- Rugged, 90 mm indicator lights that provide extremely bright and uniform illumination from all directions and longer distances.
- The K90L models have a separate input wire for internally controlled flashing
- Daylight visible models are available in both the standard and toggle models
- Illuminated dome provides easy-to-see operator guidance
- Up to five colors in one device to communicate multiple statuses
- Rugged design with an IP67-rating
- Cordsets and brackets available see page 447

LASER  
MARKING  
AVAILABLE

### K90L One to Five Color

Example Model Number: K90LGRYPQ

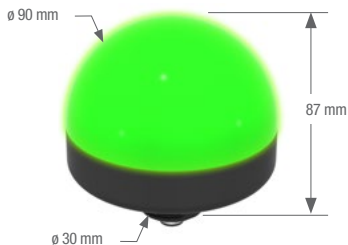
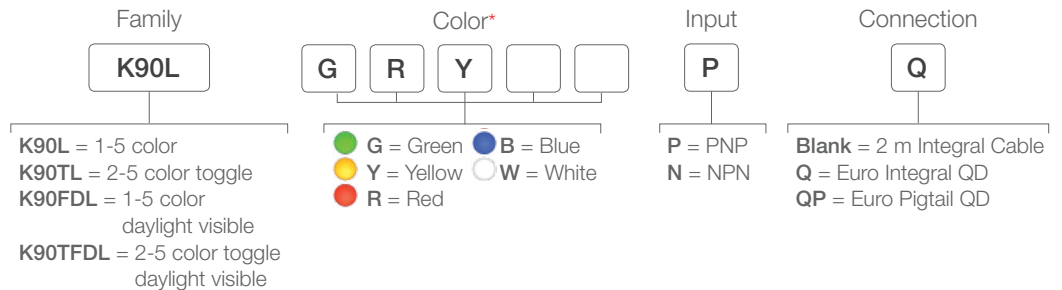

K90L and K90TL

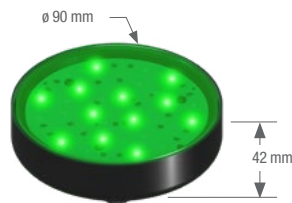

K90FDL and K90TFDL  
Daylight Visible

For more specifications see page 447.

Connection Option: A model with a QD requires a mating cordset (see page 447).

\* Single-color models are available. Colors are independently selectable. Contact factory for other colors and color combinations.

# K50 Beacon Series

## High-intensity Indicator



- Extremely bright, making them ideal for indoor and outdoor areas with high levels of ambient light.
- UV-stabilized polycarbonate housing and epoxy encapsulated electronics allow for years of maintenance-free operation.
- They are available in five colors and a wide range of voltage levels
- Continuous, strobing and rotating models available
- 12-30 V dc models are ideal for battery-powered mobile applications
- Models with LEDs emitting from the top in addition to the perimeter
- Rugged, sealed housing rated to IP69K for high-pressure washdown
- Models for 120 V and 230 V ac operation
- Cordsets and brackets available see page 447



### K50BL & K50BCL One or Two Color, 12-30 V DC

Example Model Number: K50BLR1XGXPQ



### K50BL & K50BCL One Color, 85-250 V AC

Example Model Number: K50BLGA120Q



 Connection Option: A model with a QD requires a mating cordset (see page 447).

\* Rotating only available on K50BL models.  
\*\* Strobing only available on K50BCL models.

# K50 Daylight Visible Series

## Directional Indicator



- Flat 50 mm profile with high-intensity LEDs that clearly show status indication
- Intense levels of light output for outdoor environments or in areas with high levels of ambient light
- Easy-to-install 30 mm threaded base mount, no tools required
- Up to three colors in one device to communicate multiple statuses
- Rugged design for many years of operation
- Completely self-contained, no controller needed
- Cordsets and brackets available see page 447

### K50LD One- or Three- Color, 12-30 V DC

Example Model Number: K50LDXGXPO

Family	Color			Input	Connection
	1	2	3		
K50LD	X	G	X	P	Q
<ul style="list-style-type: none"> <li><span style="color: green;">●</span> G = Green</li> <li><span style="color: blue;">●</span> B = Blue</li> <li><span style="color: yellow;">●</span> Y = Yellow</li> <li><span style="color: red;">●</span> R = Red</li> <li><span style="color: white;">○</span> W = White</li> <li>X = Not used</li> </ul>	<ul style="list-style-type: none"> <li>P = PNP</li> <li>N = NPN</li> <li>S1 = Modbus</li> </ul>		<ul style="list-style-type: none"> <li>Blank = 2 m Integral Cable</li> <li>Q = Euro Integral QD</li> <li>QP = Euro Pigtail QD</li> </ul>		



K50L Daylight Models

### K50LD One Color, 85-130 V AC

Example Model Number: K50LDGA120Q

Family	Color	Input	Connection
K50LD	G	A120	Q
<ul style="list-style-type: none"> <li><span style="color: green;">●</span> G = Green</li> <li><span style="color: blue;">●</span> B = Blue</li> <li><span style="color: yellow;">●</span> Y = Yellow</li> <li><span style="color: red;">●</span> R = Red</li> <li><span style="color: white;">○</span> W = White</li> <li>X = Not used</li> </ul>	<ul style="list-style-type: none"> <li>A120 = 85-130 V ac</li> </ul>		<ul style="list-style-type: none"> <li>Blank = 2 m Integral Cable</li> <li>Q = Micro Integral QD</li> <li>QP = Micro Pigtail QD</li> </ul>

### K30L, K50L, K70L, K90L Base-Mount Specifications

Supply Voltage and Current	<p><b>K90L:</b> 12 to 30 V dc; 475 mA Max. at 12 V dc; 175 mA Max. at 30 V dc</p> <p><b>K70L:</b> 12 V to 30 V dc; 200 mA Max. at 12 V dc; 90 mA Max. at 30 V dc</p> <p><b>K50L:</b> 18 to 30 V dc (10% max. ripple)</p> <p><b>Indicators:</b> 65 mA at 12 V dc; 35 mA at 30 V dc max. current per color</p> <p><b>Audible:</b> 35 mA max. current</p> <p><b>K50LD:</b> 15 to 30 V dc; 85 to 130 V ac or 75 to 120 V dc @ 16 mA max.</p>	<p><b>K50BL:</b> 12 to 30 V dc; 85 to 130 V ac or 75 to 120 V dc; 100 to 250 V ac or 90 to 240 V dc</p> <p><b>K30L:</b> 10 to 30 V dc</p> <p><b>K50L2:</b> 10 to 30 V dc; 220mA Max. at 10 V dc; 100mA Max. at 30 V dc</p> <p><b>K30L2:</b> 10 to 30 V dc; 60mA Max. at 10 V dc; 30mA Max. at 30 V dc</p>
Supply Protection Circuitry	Protected against reverse polarity, transient voltages	
Construction	Polycarbonate housing	
Environmental Rating	<p><b>K90L:</b> IEC IP67</p> <p><b>K70L:</b> IEC IP65</p> <p><b>K30L, K30L2:</b> IEC IP67/IP69K</p>	<p><b>K50L, K50L2:</b> IEC IP67/IP69K</p> <p><b>Audible Models: Standard:</b> IEC IP50 <b>Sealed:</b> IEC IP67/IP69K</p> <p><b>K50LD, K30LD, K50BL:</b> IEC IP67/IP69K</p>
Operating Temperature	-40 to 50 °C	
Certifications	<p>K90L, K70L, K30L, K50L:  K90L, K70L, K30L, K50L:  (Depending on model)</p>	

Connection Option: A model with a QD requires a mating cordset (see page 447).

# K30L and K50L Hazardous Area

## Domed Indicator



- 30 and 50 mm models rated to IP67 and IP69K for use in harsh environments, making them nearly indestructible
- Extensive approvals ensure indicator lights are safe to use in every classified zone or area
- Up to three colors in one device and five colors to choose from
- Long-lasting LED technology for years of maintenance-free operation
- Unique design appears gray when off, eliminating false indication from ambient light
- Worldwide IECEx approval for quicker access into countries outside Europe and North America

### K30L and K50L Hazardous Area

Example Model Number: K50LIGRYPQ



K30L Models

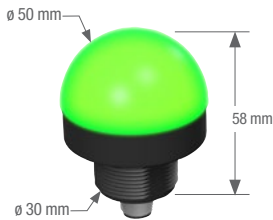

K50L Models

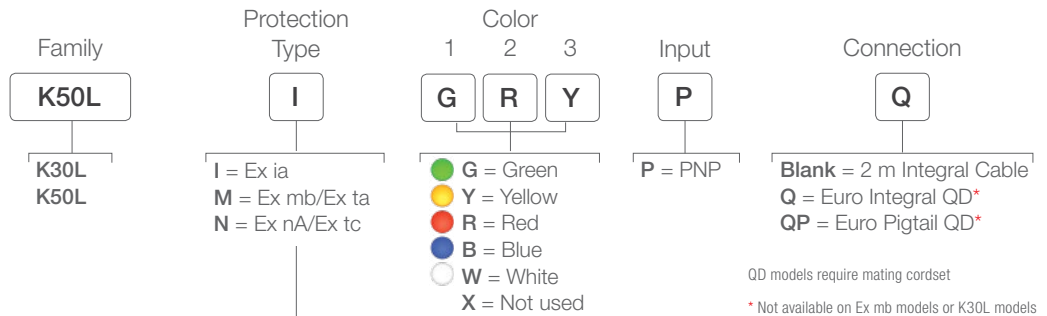

Indicator Family	Protection Method	Suitable for ATEX	Suitable for NEC & CEC
Ex ia	Intrinsically Safe	<b>Gas Zones:</b> 0, 1, & 2 <b>Dust Zones:</b> 20, 21, & 22 mines	<b>Gas zones:</b> 0, 1, & 2 Class I Division 1 & 2 Class II/III Division 1 & 2
Ex mb/Ex ta	Encapsulation/ Enclosure	<b>Gas Zones:</b> 1 & 2 <b>Dust Zones:</b> 20, 21 & 22	<b>Gas zones:</b> 1 & 2 Class I Division 2 Class II/III Division 1 & 2
Ex nA/Ex tc	Non-Sparking/ Enclosure	<b>Gas Zones:</b> 2 <b>Dust Zones:</b> 22	<b>Gas zones:</b> 2 Class I Division 2 Class II/III Division 2

### K50L & K30L Hazardous Area Specifications

Supply Voltage and Current	Exia: 8-30 V dc Ex mb/Ex ta and Ex nA/Ex tc: 10-30 V dc
Supply Protection Circuitry	Protected against reverse polarity, transient voltages
Construction	Polycarbonate housing
Environmental Rating	IEC IP67 and IP69K
Operating Temperature	-40 to +50 °C
Certifications	

Connection Option: A model with a QD requires a mating cordset.



## TOUCH BUTTONS

## PICK-TO-LIGHT



4-Pin

### Euro-Style

Straight connector models listed; for right-angle, add **RA** to the end of the model number (example, **MQDC-406RA**)

**MQDC-406**  
2 m (6.5')  
**MQDC-415**  
5 m (15')  
**MQDC-430**  
9 m (30')

Additional cordset information is available. See page 758



SMB30FA



SMB22FVK

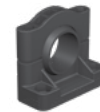

SMB30SC



SMB30A

Additional bracket information is available. See page 727

## Flush Foldable Bracket

Description	Model
Black	SA-FFB12
Gray	SA-FFB12C





## EZ-LIGHT® Controllers

Description	Function	Model
5 toggle switches	ON-OFF-FLASH	LC80T
12 position rotary switch	ON-OFF-FLASH	LC80R



## Elevated Mount System

Features	Model	Components
<ul style="list-style-type: none"> <li>Streamlined black acetal or white UHMW stand-off pipe adapter/cover</li> <li>Connects between 30 mm light base and ½ in. NPSM/DN15 pipe</li> <li>Mounting hardware included</li> </ul>	<p><b>SA-M30TE12</b> (black acetal)</p> <p><b>SA-M30TE12C</b> (white UHMW)</p>	
<ul style="list-style-type: none"> <li>Elevated-use stand-off pipe (½ in. NPSM/DN15)</li> <li>Polished 304 stainless steel, black anodized aluminum, or clear anodized aluminum surface</li> <li>½ in. NPT thread at both ends</li> <li>Compatible with most industrial environments</li> </ul>	<p><b>Polished 304 Stainless Steel</b></p> <p><b>SOP-E12-150SS</b> 150 mm (6") long</p> <p><b>SOP-E12-300SS</b> 300 mm (12") long</p> <p><b>SOP-E12-900SS</b> 900 mm (36") long</p>	<p><b>Black Anodized Aluminum</b></p> <p><b>SOP-E12-150A</b> 150 mm (6") long</p> <p><b>SOP-E12-300A</b> 300 mm (12") long</p> <p><b>SOP-E12-900A</b> 900 mm (36") long</p>
<ul style="list-style-type: none"> <li>Streamlined black acetal or white UHMW mounting base adapter/cover</li> <li>Connects between ½ in. NPSM/DN15 pipe and 30 mm (1-3/16 in) drilled hole</li> <li>Mounting hardware included</li> </ul>	<p><b>SA-E12M30</b> (black acetal)</p> <p><b>SA-E12M30C</b> (white UHMW)</p>	



## Barrel/T-Style Indicators

T-Style indicators come in Banner's most popular sensor housings, using the same easy-to-mount brackets and style. They come in a variety of sizes for simple setup and many application uses.

Series	Description	Number of Colors	Brightness	Dimensions	Power Supply
	<b>S18L</b> Standard intensity and high intensity daylight visible models available in a variety of colors with 18 mm bases. page 450	1 to 3 (9 color options)	Varies by model	Base: 18 mm	10 to 30 V dc
	<b>S22L</b> Standard intensity and high intensity daylight visible models available in a variety of colors with 22 mm bases. page 451	1 to 3 (9 color options)	Varies by model	Base: 22 mm	10 to 30 V dc
	<b>T8L</b> The T8L Indicators have a low profile, ideal for simple panel mounting or use on a machine. page 454	1 or 2 (3 color options)	Standard	8 mm light	10 to 30 V dc

## OTHER AVAILABLE MODELS



Base Mount

436



Flat Mount

456

# S18L Series

## Barrel-Mount Indicator



- Designed for panel-mount or stand-alone applications
- Daylight visible models available for use in outdoor applications or in areas with high levels of ambient light
- Up to three colors available in one device allowing one S18L to replace three conventional panel indicators
- Compact and light weight, extremely rugged; overmolded IP69K-rated design
- Terminal connection models have color-coded screw heads for quick, error-free wiring
- Cordsets and brackets available see page 452

### S18L Multi-Color General-Purpose

Example Model Number: S18LGRYPq

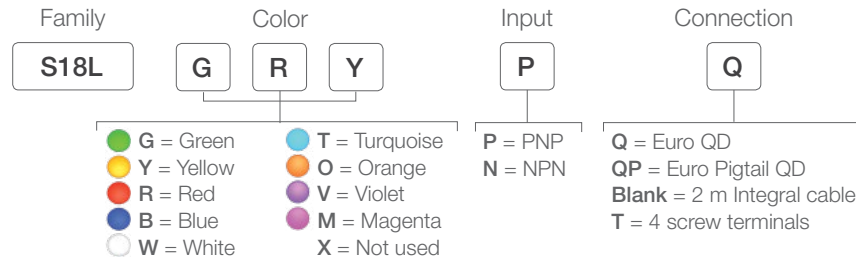

### S18DL Daylight Visible General Purpose

Example Model Number: S18DLGRYPQ

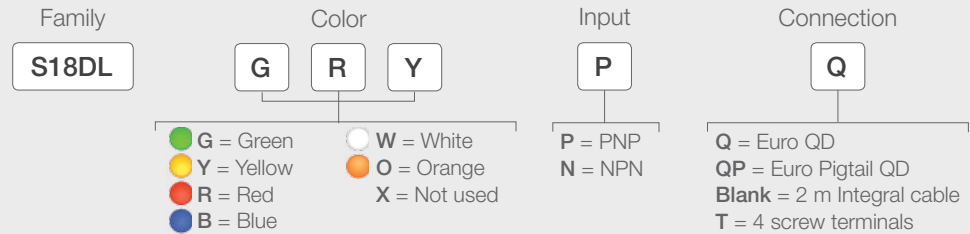

### S18DLH Daylight Visible High-Intensity

Example Model Number: S18DLHGQ

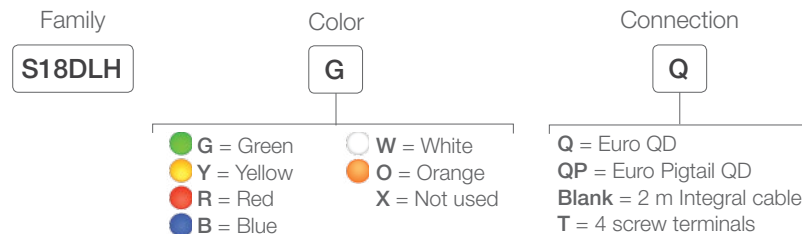

For more specifications see page 453.



Connection Option: A model with a QD requires a mating cordset (see page 452).

Single-color models are available. Colors are independently selectable. Contact factory for other colors and color combinations.

# S22L Series

## Barrel-Mount Indicator



- Designed for panel-mount or stand-alone applications
- Daylight visible models available for use in outdoor applications or in areas with high levels of ambient light
- Up to three colors available in one device allowing one S22L to replace three conventional panel indicators
- Compact and light weight, extremely rugged; overmolded IP69K-rated design
- Terminal connection models have color-coded screw heads for quick, error-free wiring
- Cordsets and brackets available see page 452

### S22L Multi-Color General Purpose

Example Model Number: S22LGRYPQ

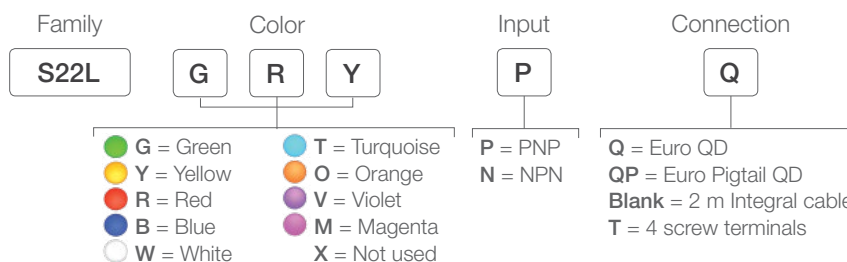

### S22DL Daylight Visible General Purpose

Example Model Number: S22DLGRYPQ

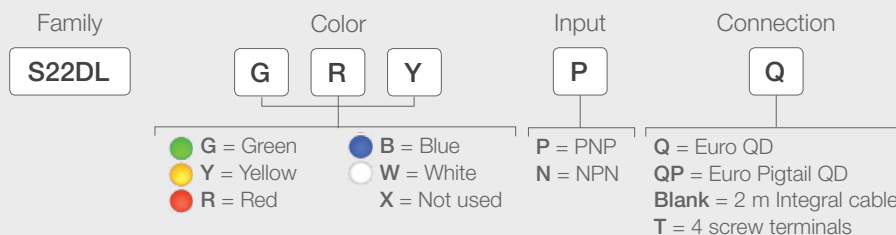

### S22DLH Daylight Visible High Intensity

Example Model Number: S22DLHGQ

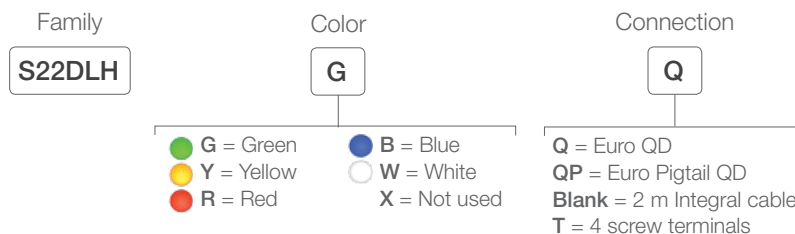

For more specifications see page 453.

Connection Option: A model with a QD requires a mating cordset (see page 452).

Single-color models are available. Colors are independently selectable. Contact factory for other colors and color combinations.



4-Pin

**Euro-Style**

Straight connector models listed; for right-angle, add **RA** to the end of the model number (example, **MQDC-406RA**)

- MQDC-406**  
2 m (6.5')
- MQDC-415**  
5 m (15')
- MQDC-430**  
9 m (30')

Additional cordset information is available.  
See page 758



**SMB18A**



**SMBAMS18P**



**SMB18FA**



**SMBAMS18RA**

Additional bracket information is available.  
See page 723

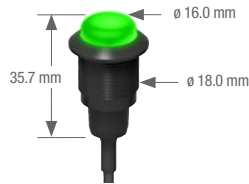

**S18L Cabled**



**S18L QD**



**S18L Field Wired**



**S22L Cabled**





**S22L QD**



**S18L Field Wired**

## Barrel Mount Specifications

Supply Voltage and Current	10 to 30 V dc @ 25 mA max. per LED color <b>S18DLH and S22DLH:</b> 9 to 30 V dc
Supply Protection Circuitry	Protected against reverse polarity, transient voltages
Construction	Polycarbonate
Environmental Rating	<b>S18L.. and S22L..:</b> IEC IP67 and IP69K
Operating Temperature	<b>S18L and S22L:</b> -40 to +50 °C <b>S18DLH and S22DLH:</b> -40 to +60 °C
Certifications	 

# T8L Series

## T-Style Indicator



- T-style mount indicators with a low profile, ideal for simple panel mounting or use on a machine
- Can be easily assembled into a punched hole with the included mounting hardware, no additional hardware needed.
- Up to two colors in one device with an 8 mm threaded nose
- Designed for panel-mount or stand-alone applications
- Right-angle wiring exit for low profile applications
- Ideal for operator guidance and equipment status indication
- Rugged design rated to IP67

### T8L One or Two Color General-Purpose

Example Model Number: T8LGRXP

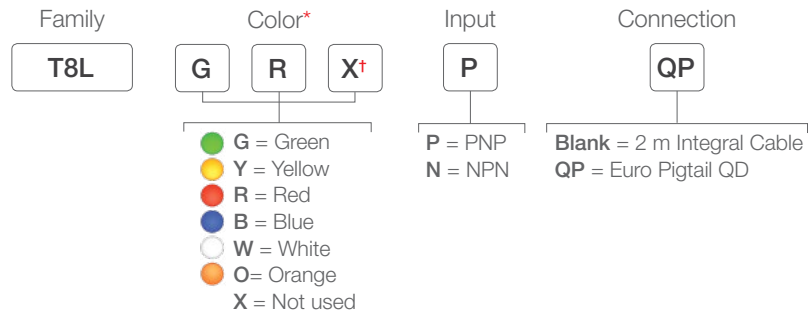

Connection Option: A model with a QD requires a mating cordset.

\* Single-color models are available. Colors are independently selectable. Contact factory for other colors and color combinations.

† Add 7 after last color option for Sensor Emulators (example, T8LGYX7PQP). Use with discrete output of photoelectric and proximity sensors to duplicate the sensor's Green and Yellow indicator function. When the sensor is powered, the Green LED is ON. When the sensor's output is energized, the Yellow LED is ON.





4-Pin

**Euro-Style**

Straight connector models listed; for right-angle, add **RA** to the end of the model number (example, **MQDC-406RA**)

**MQDC-406**  
2 m (6.5')  
**MQDC-415**  
5 m (15')  
**MQDC-430**  
9 m (30')

**SMB8MM**

*Additional cordset information is available.  
See page 758*

*Additional bracket information is available.  
See page 727*

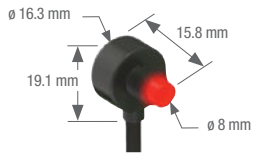

T8 Models

## T-Style Mount Specifications







Supply Voltage and Current	10 to 30 V dc @ 20 mA max.
Supply Protection Circuitry	Protected against reverse polarity, transient voltages
Construction	Polycarbonate/ABS housing; Thermoplastic diffuser
Environmental Rating	IEC IP67
Operating Temperature	-40 to +50 °C
Certifications	<b>CE</b>



---

## Flat Mount Indicators

Flat-mount indicators have large faces for clear indication, even at long distances. Flat-mount indicators come in a variety of styles, including a sleek domed design, daylight visible models for outdoor indication and all models are easy to mount to flat surfaces, such as walls and panels.

Series	Description	Number of Colors	Brightness	Dimensions	Power Supply
	<b>K80L</b> Easy to mount to flat surfaces such as walls and panels page 458	1 to 5	Standard	80 mm housing ø 50 mm light	18 to 30 V dc
	<b>K80 Call Light</b> Portable, battery-powered lights provide operational status indication for personnel and are ideal in locations where power is limited or unavailable page 460	1	Standard	80 mm housing ø 50 mm light	Two 9 V batteries
	<b>K50FL</b> Ideal for operator guidance and equipment status indication page 461	1 to 5	Standard	60 x 40 mm ø 50 mm light	18 to 30 V dc
	<b>K80FL</b> Extremely bright indicator with selectable flash rates page 462	1 to 3	Standard or Daylight Visible	80 mm housing ø 66 mm light	12 to 30 V dc
	<b>K80 Segmented</b> Up to four individual segments that can be lighted separately page 464	1 to 4	Standard	80 mm housing ø 66 mm light	18 to 30 V dc
	<b>SP Signal Lights</b> Rugged and easy-to-install signal lights that provide high visibility outdoors page 465	1 to 3	Daylight Visible	Varies by model	15 to 30 V dc, 85 to 130 V ac
	<b>TL30F</b> A low-profile, flat-mount indicator with multiple color segments can be lit simultaneously page 466	3 or 5	Standard	H (varies) 30 x 19 mm	18 to 30 V dc

## OTHER AVAILABLE MODELS



Base Mount

436



Barrel/T-Style Mount

448

# K80L Flat-Mount Series

## Domed Indicator



- Rugged, cost-effective, flat-mount indicators that provide easy-to-see operator guidance with a 50 mm dome.
- Easy to mount to flat surfaces such as walls or panels
- High-intensity LEDs give highly visible indication and provide zero-maintenance operation
- Rugged, fully encapsulated design rated to IP67
- Up to five colors in one device to communicate multiple statuses
- Multifunction models available; contact factory

### K80L One, Two or Three Color, 18-30 V DC

Example Model Number: K80LGRYPQ

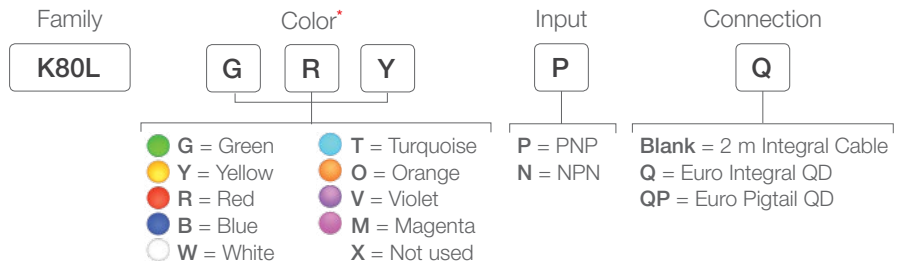

### K80L One, Two or Three Color, 85-130 V AC

Example Model Number: K80LGRYA120

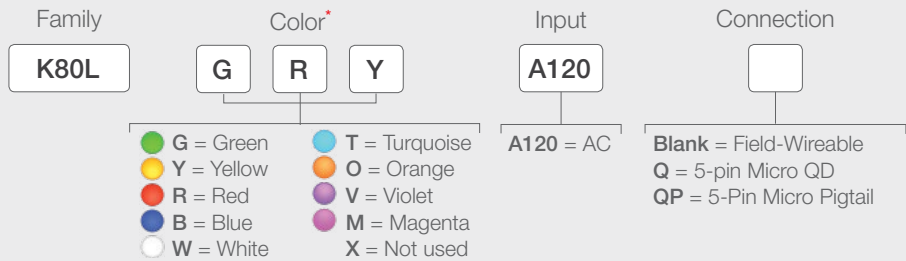

### K80L Four- to Five-Color, 18-30 V DC

Example Model Number: K80LGRYBWQ

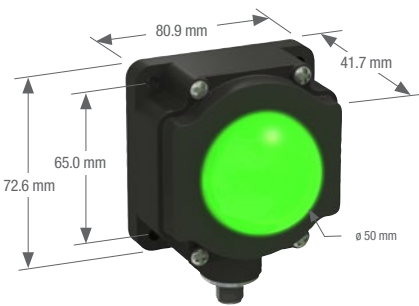
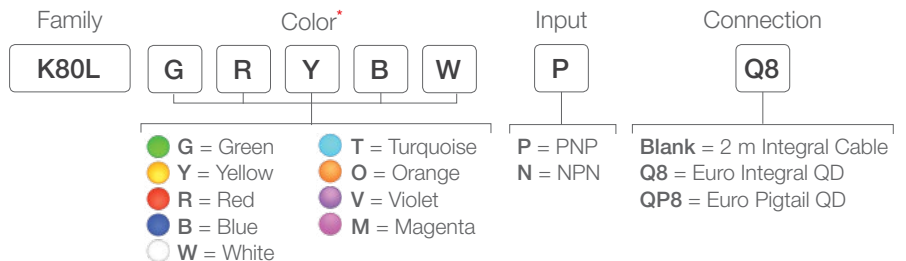

K80L Models

For more specifications see page 455.

Connection Option: A model with a QD requires a mating cordset (see page 467).

\* Add 7 after last color option for Sensor Emulators (example, K80LGRY7PQ). Use with discrete output of photoelectric and proximity sensors to duplicate the sensor's Green and Yellow indicator function. When the sensor is powered, the Green LED is ON. When the sensor's output is energized, the Yellow LED is ON.

# K80L Audible Flat-Mount Series

## Domed Indicator



- Rugged, cost-effective, and easy-to-install indicators
- Steady or pulsed sound indication
- Illuminated dome provides a big, easy-to-see job light
- Compact devices are completely self-contained—no controller needed
- Choose NPN or PNP input, depending on model
- Immune to EMI and RFI interference
- Three color LED function

### K80L One, Two or Three Color, 18-30 V DC

Example Model Number: K80LGRA1YPQ

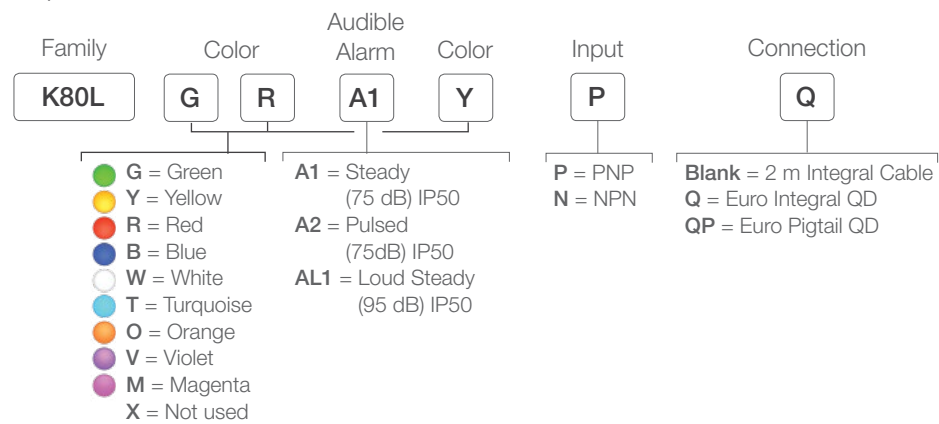

K80L Audible Models

For more specifications see page 467.

Connection Option: A model with a QD requires a mating cordset (see page 467).

# K80CL Call Light

## Battery-Operated Indicator



- Ideal in locations where power is limited or unavailable
- Flashes ON/OFF
- Switch activated
- No assembly required
- Rugged and easy to install
- Long-life LED technology gives up to 100 hours of operation on two 9 V batteries (included)

Family

K80CL

Color

R

● G = Green    ● R = Red  
● Y = Yellow    ● B = Blue

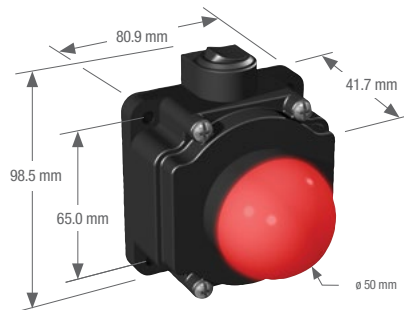

K80 Call Light

# K50FL Flat-Mount Series

## Domed Indicator



- Bright, highly visible illuminated dome
- Flat-pack mounting allows for indicators to be mounted on any flat surface
- Fully encapsulated indicators with most models rated to IP69K for high-pressure washdown environments
- Display up to five colors in a single device with many colors and color combinations available
- Long-lasting LED technology with low power consumption

### K50FL One-, Two- or Three-Color

Example Model Number: K50FLGRYPQ

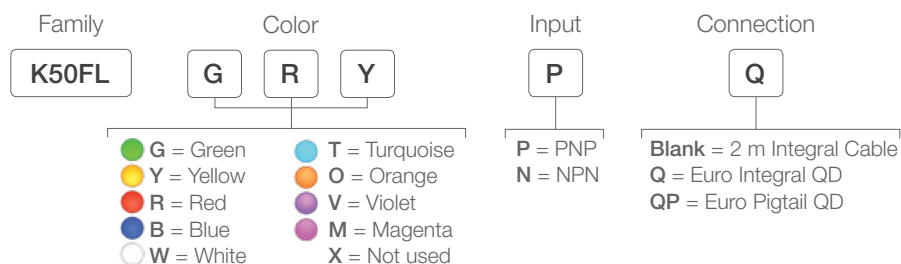

### K50FL Four-Color , Multifunction

Example Model Number: K50FLGRYW4PQ



### K50FL Five-Color

Example Model Number: K50FLGRYBWPQ

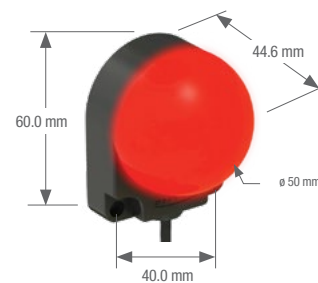
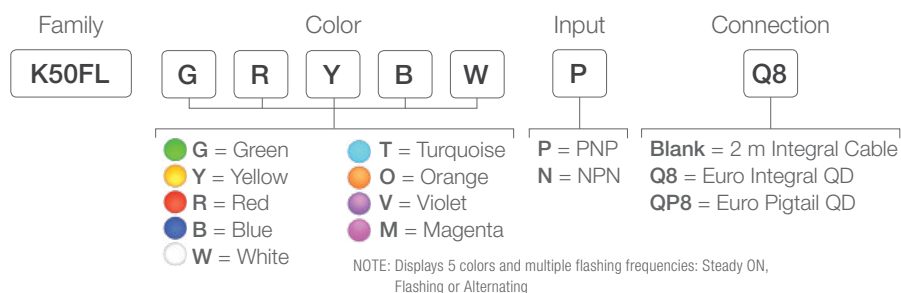

K50FL Models

For more specifications see page 467.

Connection Option: A model with a QD requires a mating cordset (see page 467).

† Add 7 after last color option for Sensor Emulators (example, K50FLGYX7PQ). Use with discrete output of photoelectric and proximity sensors to duplicate the sensor's Green and Yellow indicator function. When the sensor is powered, the Green LED is ON. When the sensor's output is energized, the Yellow LED is ON.

# K80FL Series

## Flat-Mount Indicator



- Extremely bright indicator with selectable flash rates
- Up to three colors in one device with a choice of many colors or color combinations
- Large flat face allows for clear indication from farther distances
- Easy to mount to flat surfaces such as walls or panels
- Long-lasting LED technology with low power consumption

### K80FL One-, Two- or Three Color

Example Model Number: K80FLGRYPQ

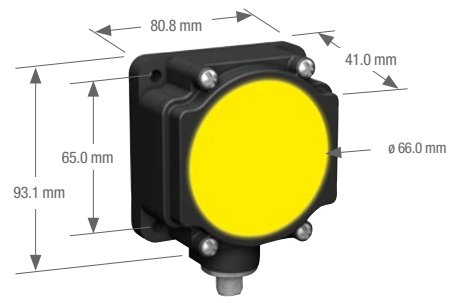
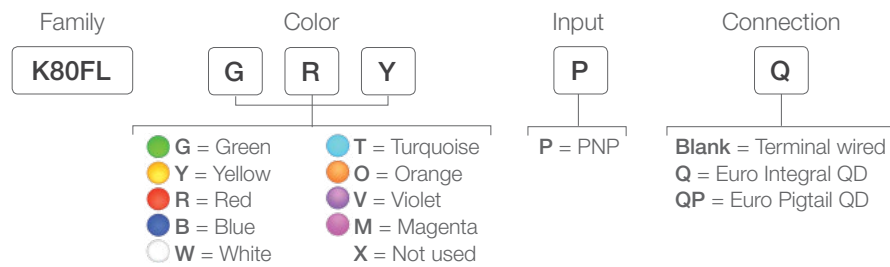

K80FL Models

For more specifications see page 467.

Connection Option: A model with a QD requires a mating cordset (see page 467).



# K80FDL Daylight Visible

## Flat-Mount Indicator



- Extremely bright indicator for outdoor use
- Up to three colors in one device with a choice of many colors or color combinations
- Large flat face allows for clear indication from farther distances
- Easy to mount to flat surfaces such as walls or panels
- Long-lasting LED technology with low power consumption

### K80FDL One-, Two- or Three Color

Example Model Number: K80FDLGRYPQ

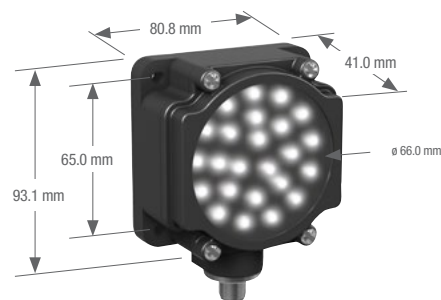
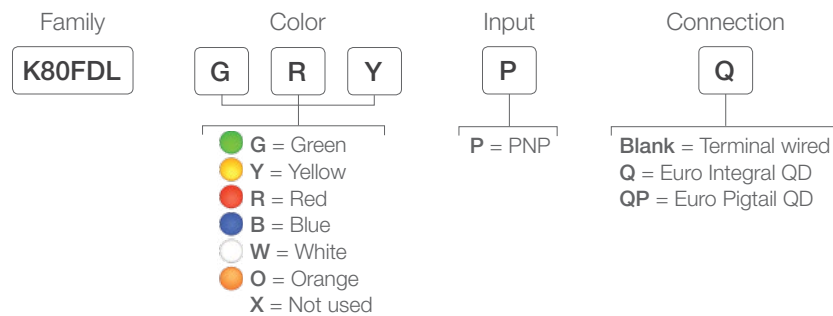

K80FDL  
Daylight Visible Models

For more specifications see page 467.

Connection Option: A model with a QD requires a mating cordset (see page 467).

# K80L Segmented Series

## Flat-Mount Indicator



- Easily mounted on flat surfaces
- Up to four individual color segments can show status of items simultaneously or in combination
- Optional, customizable labels available for enhanced segment identification
- Highly visible color segments allow for quick and easy identification of statuses

### K80L Segmented

Example Model Number: K80L4GRYB1PQ

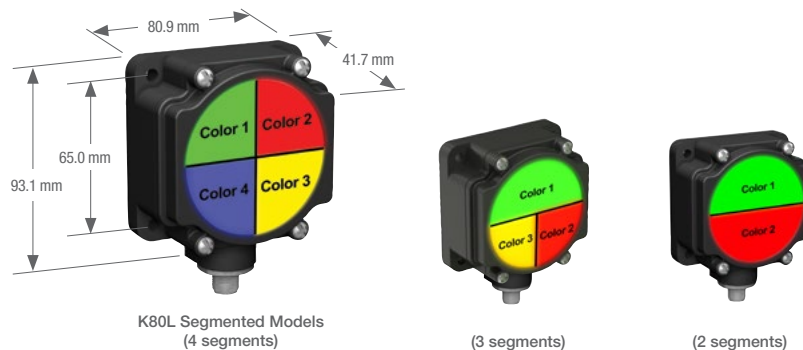
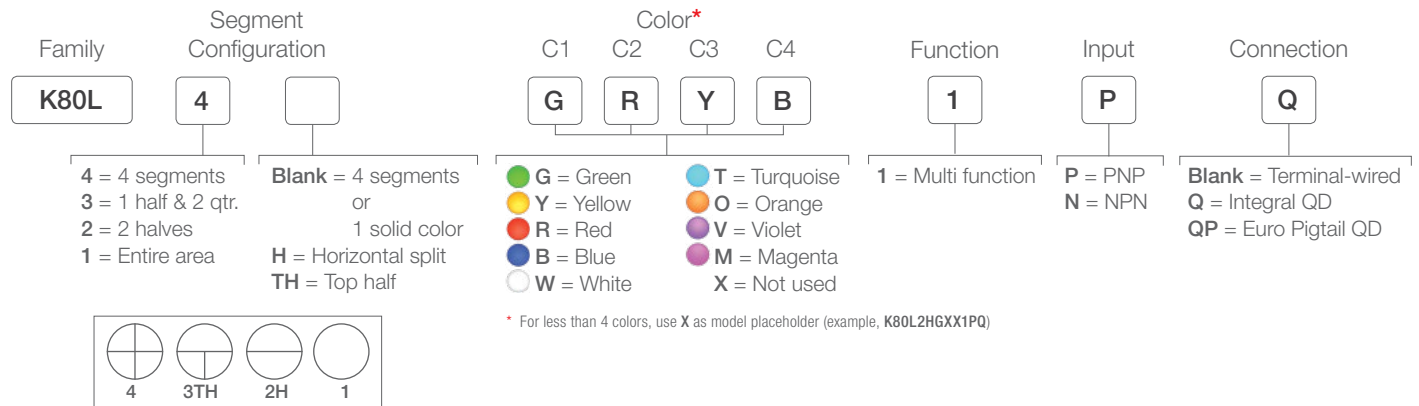

For more specifications see page 467.

Connection Option: A model with a QD requires a mating cordset (see page 467).

# SP Series Signal Light

## Flat-Mount Indicator

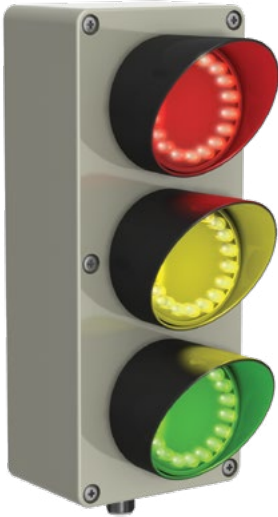

- Preassembled with up to three indicators per unit
- Rugged housing is designed to withstand wet and dirty environments.
- Intense levels of light output for use outdoors or in environments with high levels of ambient light
- Controlled field-of-view for signage and narrow lane use
- Shock, vibration and impact resistant
- Convenient Euro quick-disconnect option for easy installation
- 15 to 30 V dc or 85 to 130 V ac supply voltage, depending on model

### SP Signal Light

Example Model Number: SP150GYRPQ

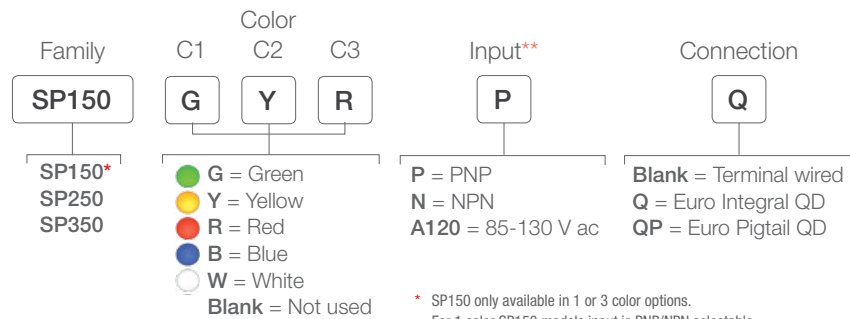

\* SP150 only available in 1 or 3 color options.

For 1 color SP150 models input is PNP/NPN selectable

\*\* A120 models are only available with field-wired connection  
SP150 models only available in PNP

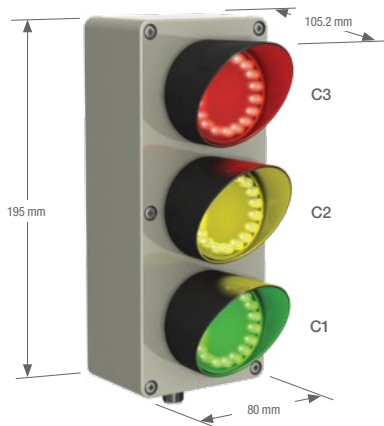

SP350 Models

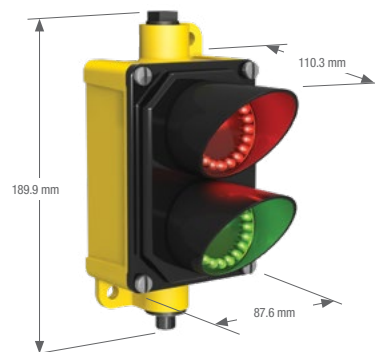

SP250 Models

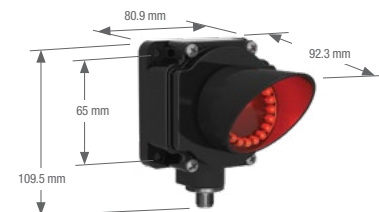

SP150 Models

For more specifications see page 467.

 Connection Option: A model with a QD requires a mating cordset (see page 467).

# TL30F Series

## Segmented Flat-Mount Indicators



- Multiple color segments can be lit simultaneously, making this a useful option for operator guidance or machine indication
- Frequently used with pick-to-light products to give operators additional visual indication such as number of parts to pick or color-coded part picking
- Displays three or five colors in single device
- Durable, rugged metal housing rated to IP65
- Easily mounts on horizontal or vertical work centers or automation machinery
- Compact devices easily fit on work stations
- 18 to 30 V dc bimodal (NPN or PNP) and 21 to 27 V ac inputs

### TL 30F Three-Color

Example Model Number: TL30FGYRQ

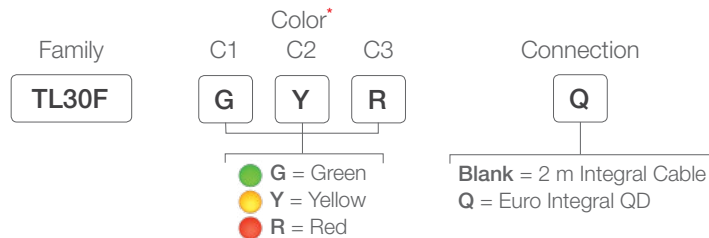

### TL 30F Five-Color

Example Model Number: TL30FWBGYRQ

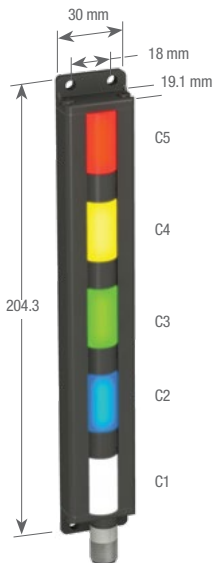
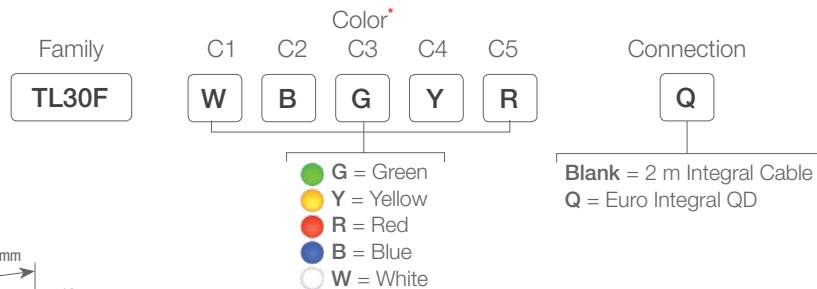

Five Color  
General-Purpose  
IP65

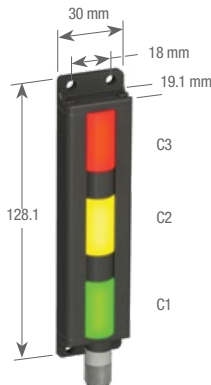

Three Color  
General-Purpose  
IP65

\* TL30F are pre-configured in three- or five-colors. Positions are set as pictured below(above). For other color combinations, please contact the factory.

Connection Option: A model with a QD requires a mating cordset.

## TOUCH BUTTONS

## PICK-TO-LIGHT

**Euro-Style**

Straight connector models listed; for right-angle, add **RA** to the end of the model number (example, **MQDEC2-506RA**)

**4-Pin**  
**MQDC-406**  
 2 m (6.5')  
**MQDC-415**  
 5 m (15')  
**MQDC-430**  
 9 m (30')

**5-Pin**  
**MQDC1-506**  
 2 m (6.5')  
**MQDC1-515**  
 5 m (15')  
**MQDC1-530**  
 9 m (30')

**8-Pin**  
**MQDC2-806**  
 2 m (6.5')  
**MQDC2-815**  
 5 m (15')  
**MQDC2-830**  
 9 m (30')

**Micro-Style**

Straight connector models listed; for right-angle, add **RA** to the end of the model number (example, **MQDC-306RA**)

**3-Pin**  
**MQDC-306**  
 2 m (6.5')  
**MQDC-315**  
 4 m (12')  
**MQDC-330**  
 9 m (30')

**5-Pin**  
**MQVR3S-506**  
 2 m (6.5')  
**MQVR3S-515**  
 4 m (12')  
**MQVR3S-530**  
 9 m (30')

Additional cordset information is available.  
 See page 758



**SMBDX80DIN**  
 use with K80L



**DIN-35...**  
 use with K80L



**SMBPVA1**  
 use with TL30F



**SMBPVA2**  
 use with TL30F



**SMBPVA6**  
 use with TL30F

Additional bracket information is available.  
 See page 727

## Flat-Mount Specifications





<b>Supply Voltage and Current</b>	<p><b>K80L:</b> 18-30 V dc  <b>K80CL:</b> 18 V (two batteries)  <b>K80FL:</b> 12-30 V dc  <b>K80FDL:</b> 12-30 V dc  <b>K80 Segmented displays:</b> 18-30 V dc  <b>K80L4:</b> @ 35 mA max. per LED color, @ 90 mA max. with all LEDs ON;  <b>K80L3:</b> @ 50 mA max. with color 1 ON, @ 35 mA max. with colors 2 or 3 ON, @ 90 mA max. with all LEDs ON;  <b>K80L2:</b> @ 50 mA max. with colors 1 or 2 ON, @ 90 mA max. with all LEDs ON;  <b>K80L1:</b> @ 90 mA max  <b>SP150, SP250, SP350:</b> 15-30 V dc 1-Color: @ 120 mA max. per LED color; 3-Color: @ 40 mA max. per LED color  <b>K50FL:</b> 18-30 V dc  <b>TL30F:</b> 18-30 V dc (10% max. ripple) or 21-27 V ac @ 18mA max. per LED color</p>
<b>Supply Protection Circuitry</b>	Protected against reverse polarity, transient voltages
<b>Environmental Rating</b>	<p><b>K80L:</b> IP67  <b>K80L:</b> Audible: IP50  <b>K80CL:</b> IP50  <b>K80FL:</b> IP67  <b>K80FDL:</b> IP67  <b>K80 Segmented displays:</b> IP67  <b>SP150:</b> IP67  <b>SP250, SP350:</b> IP65  <b>K50FL:</b> IP69K  <b>TL30F:</b> IP65</p>
<b>Operating Temperature</b>	<p>-40 to +50 °C  <b>Audible models:</b> -20 to 50 °C  <b>K80CL:</b> -20 to 50 °C</p>
<b>Certifications</b>	<b>CE</b>



---

## Touch Buttons

Banner is the leader in ergonomic, visual and sealed operator touch buttons for industrial applications. Since Banner's Touch Buttons can have multiple colors and I/O capabilities, they can replace several conventional buttons, making them ideal in lean manufacturing environments. Buttons have superior immunity to direct water spray and have the ability to be used while wearing gloves.

Series	Description	Number of Colors	Dimensions	Power Supply	Communications
	<b>K30</b> Versatile family that combines a small, bright indicator with solid-state switching capability activated by a simple touch. page 468	1 to 3 (9 color options)	<b>Base:</b> 22 mm <b>Dome:</b> 30 mm	12 to 30 V dc	
	<b>K50</b> Versatile family that combines a large, bright indicator with solid-state switching capability activated by a simple touch. page 472	1 to 3 (9 color options)	<b>Base:</b> 30 mm <b>Dome:</b> 50 mm	12 to 30 V dc	Modbus Option
	<b>K70</b> Large, easy to activate solid state switch and high visibility indicator. Ideal for use in pick-to-light, call button and general industrial applications. page 474	1 to 3 (5 color options)	<b>Base:</b> 30 mm <b>Dome:</b> 70 mm	12 to 30 V dc	Wireless Option
	<b>K30L</b> Features a brightly illuminated base for enhanced visual indication. page 476	1 to 3 (9 color options)	<b>Base:</b> 22 mm <b>Dome:</b> 30 mm	10 to 30 V dc	
	<b>K50L</b> Features a brightly illuminated base for enhanced visual indication. page 476	1 to 3 (9 color options)	<b>Base:</b> 30 mm <b>Dome:</b> 50 mm	12 to 30 V dc	Modbus Option
	<b>OTB/LTB</b> The industry standard for ergonomic touch buttons and are ideal as replacements for mechanical pushbuttons. page 478	—	74.2 x 59.9 x 43.2 mm <b>Base:</b> 30 mm	10 to 30 V dc, 20 to 30 V dc, 105 to 130 V ac, 210 to 250 V ac	
	<b>VTB</b> Features a brightly illuminated base for enhanced visual indication. page 480	2 (3 color options)	73.3 x 59.9 x 43.2 mm <b>Base:</b> 30 mm	12 to 30 V dc	

# K30 Touch Series

## Touch Buttons



- Totally independent of the touch activated output, making these devices flexible for use in countless applications.
- Up to three independent colors in one unit with many color options available
- Momentary versions remain activated as long as touch is present, while latching versions toggle between activated and not activated states on successive touches
- Excellent immunity to false triggering by water spray, detergents, oils, and other foreign materials
- Rugged, water-resistant IP69K design for washdown environments
- Ergonomically designed to eliminate hand, wrist and arm stresses, requiring no physical pressure to operate and can be actuated with bare hands or work gloves

### K30 Multipurpose Touch Button, One-, Two- or Three Color,

Example Model Number: K30APT2GRYF2Q

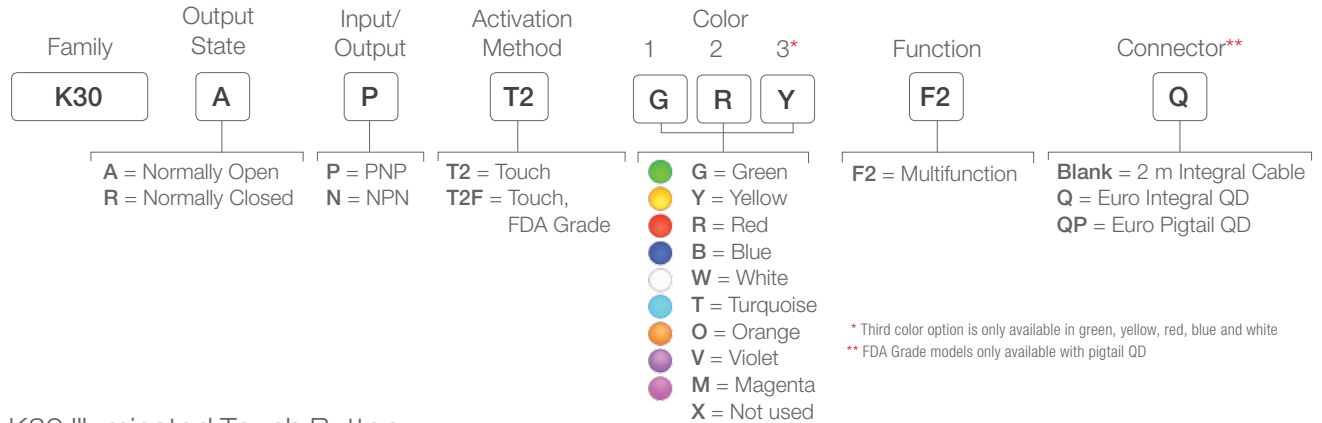

### K30 Illuminated Touch Button,

Example Model Number: K30ALBT2GRHQ

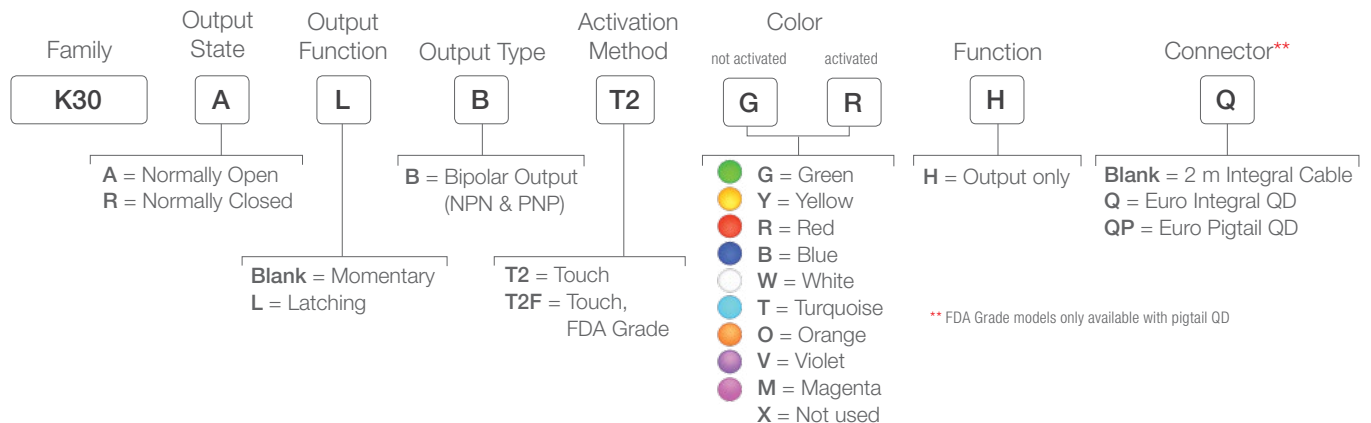

Connection Option: A model with a QD requires a mating cordset.





4-Pin

**Euro-Style**

Straight connector models listed; for right-angle, add **RA** to the end of the model number (example, **MQDC-406RA**)

**MQDC-406**

2 m (6.5')

**MQDC-415**

5 m (15')

**MQDC-430**

9 m (30')

Additional cordset information is available.  
See page 758



SMB22A



SMB22FVK



SMBAMS22P



SMB22RAVK

Additional bracket information is available.  
See page 727



K30



K30 with Food-Grade Housing

## K30 Touch Specifications

Supply Voltage	12 to 30 V dc
Supply Current	55 mA max current (exclusive of load)
Supply Protection Circuitry	Protected against reverse polarity and transient voltages
Construction	<b>Housing:</b> Polycarbonate or FDA Grade Polycarbonate, depending on model <b>Translucent dome:</b> Polycarbonate or FDA Grade Polycarbonate, depending on model <b>Mounting Nut:</b> PBT
Environmental Rating	<b>Standard:</b> UL Type 4x, 13 <b>FDA Grade:</b> UL Type 4x IEC IP67, IP69K per DIN 40050-9 Cabled models also meet IP69K if the cable and cable entrance are protected from high-pressure spray
Connections	Integral 4-pin Euro style QD, or 2 m PVC integral cable, or 4-pin 150 mm Euro-style PVC pigtail QD
Operating Conditions	<b>Temperature:</b> -40 to +50 °C <b>Max. Relative Humidity:</b> 90% @ +50 °C max. relative humidity (non-condensing) <b>Storage Temperature:</b> -40 to +70 °C
Certifications	CE 

# K50 Touch Series

## Touch Buttons



- Inputs are totally independent of the touch activated output, making these devices flexible for use in countless applications.
- Up to three independent colors in one unit with many color options available
- Momentary versions remain activated as long as touch is present, while latching versions toggle between activated and not activated states on successive touches
- Excellent immunity to false triggering by water spray, detergents, oils, and other foreign materials
- Rugged, water-resistant IP69K design for washdown environments
- Ergonomically designed to eliminate hand, wrist and arm stresses, requiring no physical pressure to operate and can be actuated with bare hands or work gloves

### K50 Multipurpose

Example Model Number: K50APT2GRYF2Q



### K50 Illuminated

Example Model Number: K50ALBT2GRHQ

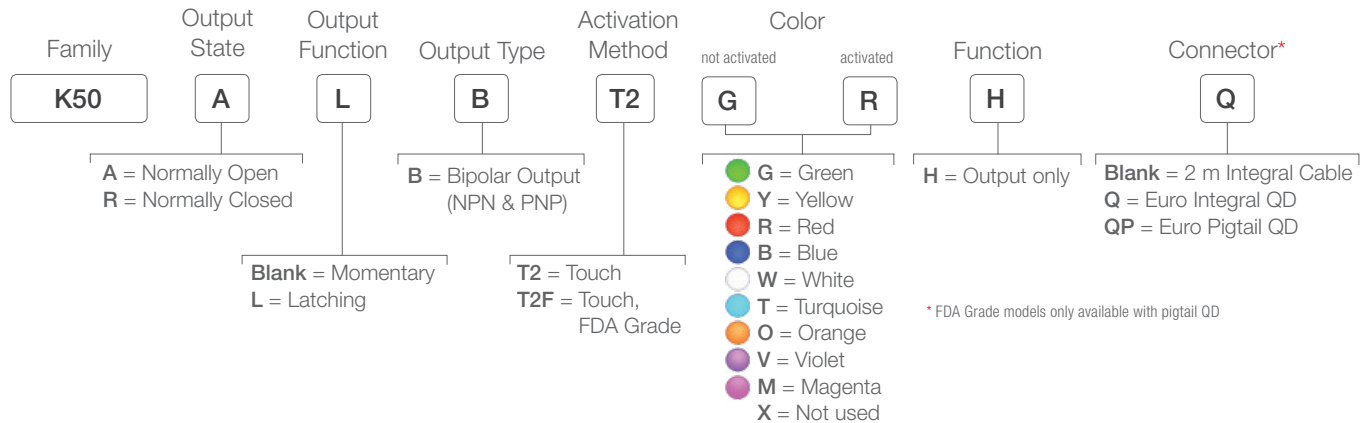

Connection Option: A model with a QD requires a mating cordset.

## TOUCH BUTTONS

## PICK-TO-LIGHT



5-Pin

**MQDC1-501.5**  
0.5 m (1.6')  
**MQDC1-506**  
2 m (6.5')  
**MQDC1-515**  
5 m (15')  
**MQDC1-530**  
9 m (30')

### Euro-Style

Straight connector models listed; for right-angle, add **RA** to the end of the model number (example, **MQDC1-506RA**)



8-Pin

**MQDC2-806**  
2 m (6.5')  
**MQDC2-815**  
5 m (15')  
**MQDC2-830**  
9 m (30')  
**MQDC2-850**  
15 m (50')

### Euro-Style

Straight connector models listed; for right-angle, add **RA** to the end of the model number (example, **MQDC2-806RA**)

Additional cordset information is available.  
See page 758



SMB30A



SMB30MM

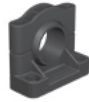

SMB30SC

Additional bracket information is available.  
See page 727

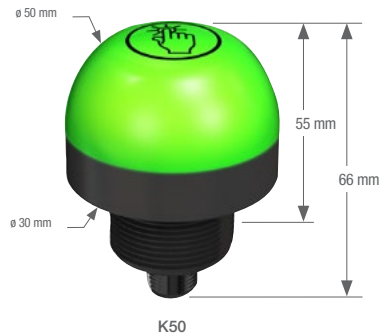

K50



K50 with Food-Grade Housing



Custom laser marking available

## K50 Touch Specifications

Supply Voltage	12 to 30 V dc
Supply Current	Less than 75 mA max current at 12 V dc (exclusive of load) Less than 50 mA max current at 30 V dc (exclusive of load)
Supply Protection Circuitry	Protected against reverse polarity and transient voltages (fast transient and over-voltage) and reverse polarity
Construction	<b>Housing:</b> Polycarbonate or FDA Grade Polycarbonate, depending on model <b>Translucent dome:</b> Polycarbonate or FDA Grade Polycarbonate, depending on model <b>Mounting Nut:</b> PBT
Environmental Rating	<b>Standard:</b> UL Type 4x, 13 <b>FDA Grade:</b> UL Type 4x IEC IP67, IP69K per DIN 40050-9. Cabled models also meet IP69K if the cable and cable entrance are protected from high-pressure spray
Connections	Integral 5-pin Euro style QD, or 2 m PVC integral cable, or 5-pin 150 mm Euro-style PVC pigtail QD
Operating Conditions	<b>Temperature:</b> -40 to +50 °C <b>Max. Relative Humidity:</b> 90% @ +50 °C max. relative humidity (non-condensing) <b>Storage Temperature:</b> -40 to +70 °C
Certifications	

# K70 Touch Series

## Illuminated Touch Buttons



- Excellent immunity to false triggering by water spray, detergents, oils, and other foreign materials
- Ergonomically designed to eliminate hand, wrist, and arm stresses associated with repeated switch operation; require no physical force to operate
- Can be actuated with bare hands or in gloves
- Rugged IP65 polycarbonate construction
- Momentary versions remain activated as long as touch is present
- Latching versions start up not activated and toggle between activated and not activated on successive touches
- Available in five color options and one-, two- and three-color models

### K70 Multipurpose Touch Button

Example Model Number: K70APT2GRYF2Q

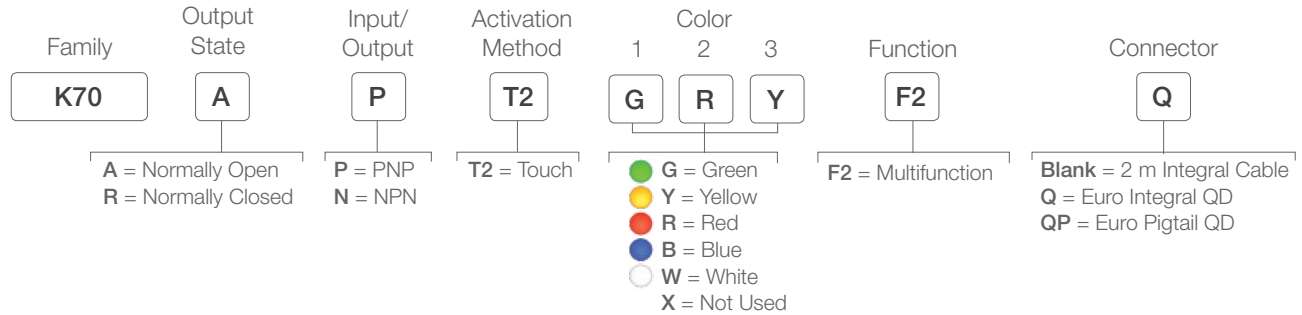

### K70 Illuminated Touch Button

Example Model Number: K70ALBT2XGHQ

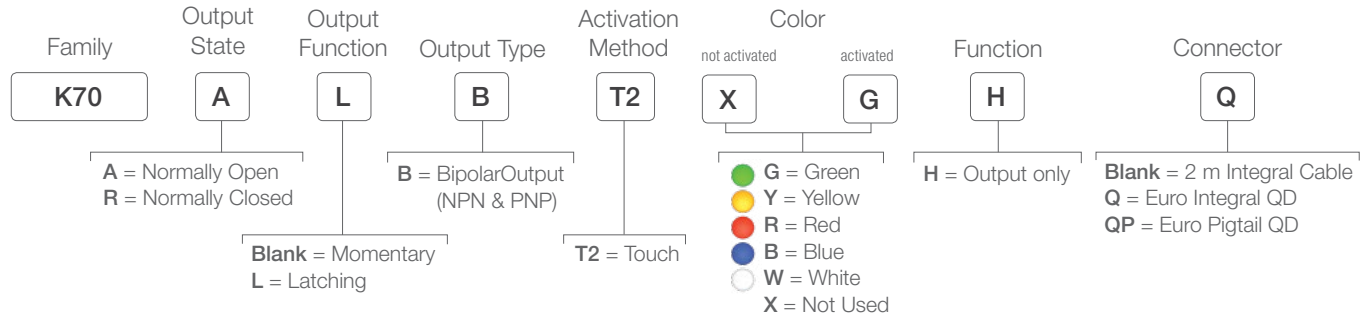

Connection Option: A model with a QD requires a mating cordset.

## K70 Wireless Touch Button

Example Model Number: K70DXN2T2GRYQ

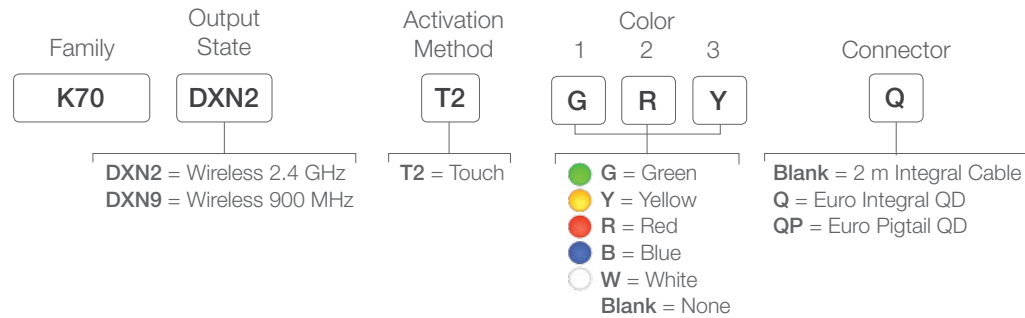

## 5-Pin

**Euro-Style**  
Straight connector models listed;  
for right-angle, add **RA** to the end  
of the model number (example,  
**MQDC1-506RA**)

**MQDC1-501.5**  
0.5 m (1.6')  
**MQDC1-506**  
2 m (6.5')  
**MQDC1-515**  
5 m (15')  
**MQDC1-530**  
9 m (30')



SMB30A



SMB30MM



SMBAMS30P





SSA-MBK-EEC1

Additional cordset information is available.  
See page 758

Additional bracket information is available.  
See page 727

## K70 Touch Specifications

Supply Voltage	12 to 30 V dc
Supply Current	< 220 mA maximum current at 12 V dc < 110 mA maximum current at 30 V dc
Supply Protection Circuitry	Protected against transient voltages
Radio Range* (Wireless Models)	<b>900 MHz, 1 Watt (Internal antenna):</b> Up to 3.2 km (2 miles) <b>2.4 GHz, 65 mW (Internal antenna):</b> Up to 1000 m (3280 ft) with line of sight
Separation Distance (Wireless Models)	<b>900 MHz, 1 Watt:</b> 4.57 m (15 ft) <b>2.4 GHz, 65 mW:</b> 0.3 m (1 ft)
Construction	<b>Housing:</b> Polycarbonate <b>Translucent dome:</b> Polycarbonate <b>Mounting Nut:</b> PBT
Environmental Rating	IEC IP65
Connections	Integral 5-pin Euro style QD, or 2 m PVC integral cable, or 5-pin 150 mm Euro-style PVC pigtail QD
Operating Conditions	<b>Temperature:</b> -40 to +50 °C <b>Max. Relative Humidity:</b> 95% @ +50 °C max. relative humidity (non-condensing)
Certifications	 

\* Radio range significantly decreases without line of sight. Always verify your wireless network's range by running a site survey.

# K30L and K50L Series

## Illuminated Push Buttons



- Feature sealed push button that can withstand washdown applications
- Extremely bright and can be seen from all directions due to their unique shape
- Rugged, encapsulated construction allows them to be used as stand alone devices without an enclosure
- Up to three colors in one device with a variety of colors for customized indication
- Quick-disconnect models for easy installation
- Dry contact switch output is completely isolated from the LED indicator input
- Designed for panel-mount or stand-alone applications

### K30L Push Button

Example Model Number: K30LGRYPPB2Q

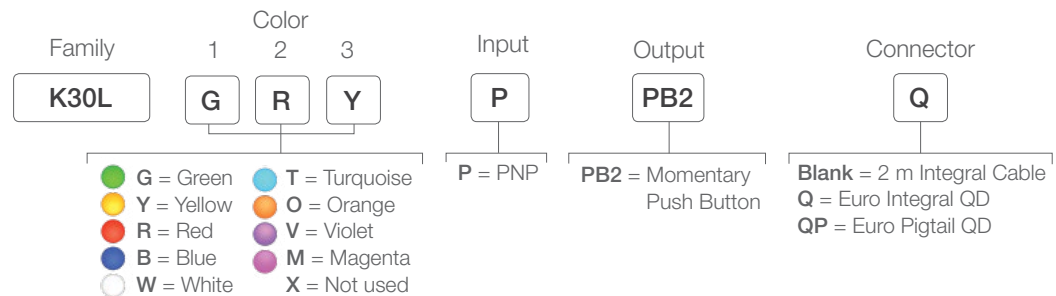

### K50L Push Button

Example Model Number: K50LGRYPPB2Q

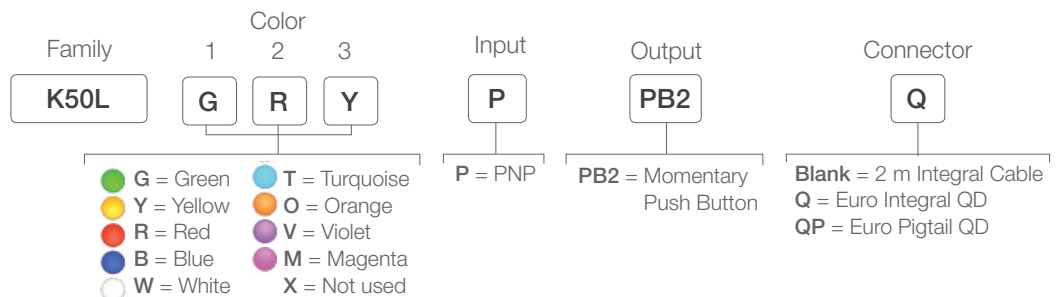

Connection Option: A model with a QD requires a mating cordset.



5-Pin

**Euro-Style**

Straight connector models listed; for right-angle, add **RA** to the end of the model number (example, **MQDC1-506RA**)

**MQDC1-501.5**  
0.5 m (1.6')  
**MQDC1-506**  
2 m (6.5')  
**MQDC1-515**  
5 m (15')  
**MQDC1-530**  
9 m (30')



8-Pin

**Euro-Style**

Straight connector models listed; for right-angle, add **RA** to the end of the model number (example, **MQDC2-806RA**)

**MQDC2-806**  
2 m (6.5')  
**MQDC2-815**  
5 m (15')  
**MQDC2-830**  
9 m (30')  
**MQDC2-850**  
15 m (50')

Additional cordset information is available.  
See page 758

**SMB22A**

for use with K30

**SMB30A**

for use with K50

Additional bracket information is available.  
See page 727



K30L Push Models

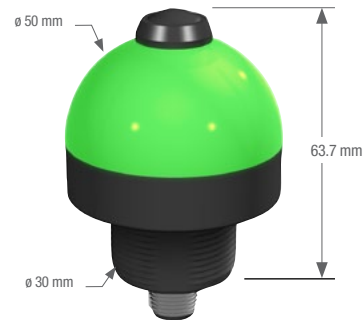

K50L Push Models

## K30L and K50L Illuminated Push Button Specifications

Supply Voltage and Current	<b>K30:</b> 10 to 30 V dc @ 40 mA max. per LED color <b>K50:</b> 12 to 30 V dc 65 mA @ 12 V dc; 35 mA @ 30 Vdc max. per LED color
Supply Protection Circuitry	Protected against reverse polarity and transient voltages (fast transient and over-voltage) and reverse polarity
Output Protection Circuitry	Protected against false pulse on power-up and continuous overload or short circuit of output
Construction	<b>Base:</b> Polycarbonate <b>Translucent dome:</b> Polycarbonate <b>Push button:</b> Thermoplastic
Environmental Rating	IEC IP65
Connections	Integral Euro-style QD fitting, PVC-jacketed 2 m cable or 150 mm PVC pigtail with QD, depending on model
Operating Conditions	<b>Temperature:</b> -40 to +50 °C <b>Max. Relative Humidity:</b> 90% @ +50 °C max. relative humidity (non-condensing) <b>Storage Temperature:</b> -40 to +70 °C
Certifications	<b>CE</b>

# OTB/LTB Series

## Optical Touch Buttons



- LED indicators to signal “power on” and “output active” conditions.
- Optimized for easy mounting with 30 mm threaded base
- Ergonomic design eliminates hand, wrist and arm stress
- Momentary and alternate action models available
- Available in a wide variety of voltage ranges and output types to suit any application
- Field covers (black) included to prevent inadvertent activation from loose clothing, debris, etc.

### OTB

Example Model Number: OTBVP6QD

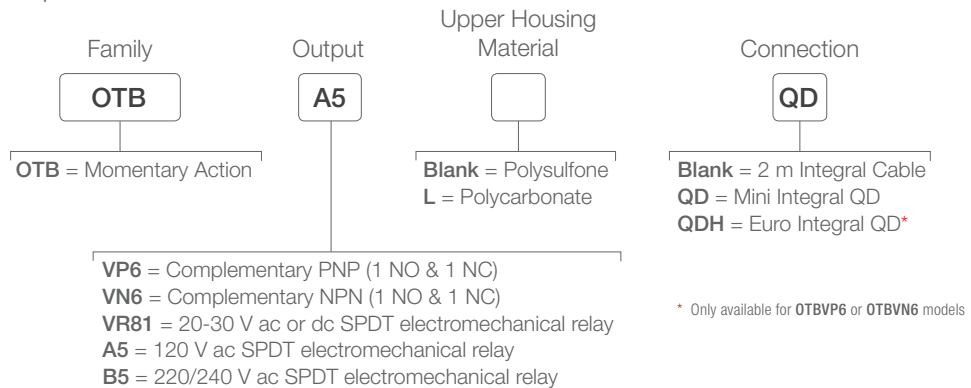

### LTB

Example Model Number: LTBA5QD

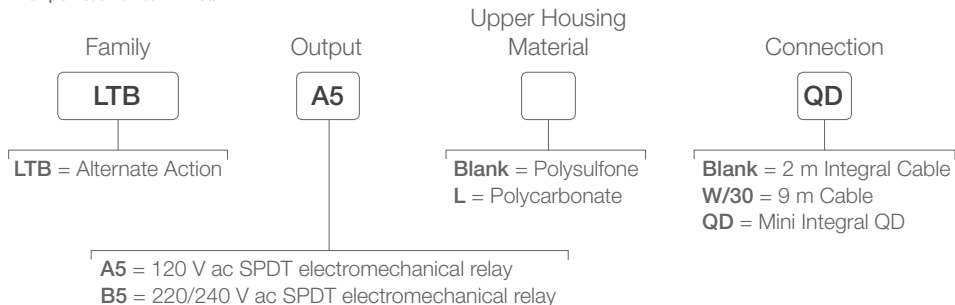

Connection Option: A model with a QD requires a mating cordset.



# TOUCH BUTTONS

# PICK-TO-LIGHT



4-Pin

**Euro-Style**  
Straight connector models listed; for right-angle, add **RA** to the end of the model number (example, **MQDC-406RA**)

**MQDC-406**  
2 m (6.5')  
**MQDC-415**  
5 m (15')  
**MQDC-430**  
9 m (30')



4-Pin

**Mini-Style**  
Straight connector models only

**MBCC-406**  
2 m (6.5')  
**MBCC-412**  
4 m (12')  
**MBCC-415**  
9 m (30')

5-Pin

**MBCC-506**  
2 m (6.5')  
**MBCC-512**  
4 m (12')  
**MBCC-515**  
9 m (30')



SMB30A



SMB30MM

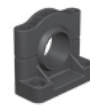

SMB30SC

Additional cordset information is available.  
See page 758

Additional bracket information is available.  
See page 728



Field Covers

**OTC-1-BK**  
Black  
**OTC-1-GN**  
Green  
**OTC-1-RD**  
Red  
**OTC-1-YW**  
Yellow

**OTCL-1-BK**  
Black  
**OTCL-1-GN**  
Green  
**OTCL-1-RD**  
Red  
**OTCL-1-YW**  
Yellow



OTB and LTB Models

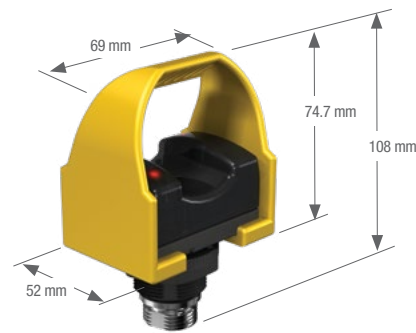

OTB and LTB Models with cover

## OTB/LTB Specifications

Supply Voltage and Current	<b>OTBVR81 models:</b> 20 to 30 V ac/dc <b>OTBA5 &amp; LTBA5 models:</b> 105 to 130 V ac, 50-60 Hz All models require less than 25 mA (exclusive of load)	<b>OTBB5 &amp; LTBB5 models:</b> 210 to 250 V ac, 50-60 Hz <b>OTBVN6/VP6 models:</b> 10 to 30 V dc
Supply Protection Circuitry	Protected against reverse polarity and transient voltages	
Output Configuration	<b>OTBVR81, OTBA5, OTBB5 and all LTB models:</b> SPDT electromechanical relay <b>OTBVN6 models:</b> Complementary NPN (sinking) open-collector transistor; 1 normally open (NO) and 1 normally closed (NC) <b>OTBVP6 models:</b> Complementary PNP (sourcing) open-collector transistors; 1 normally open (NO) and 1 normally closed (NC)	
Output Rating	<b>Electromechanical relay models:</b> <b>Max. switching current:</b> 7 amps (resistive load), 1 HP max. Min. load: 0.05 watts (dc), 0.05 VA (ac) <b>Mechanical life of relay:</b> 50,000,000 operations (min.) <b>Electrical life of relay:</b> 100,000 operations (min.) at full resistive load Transient suppression is recommended when switching inductive loads	<b>Solid-state output models:</b> 150 mA max. load (each output) <b>ON-state saturation voltage:</b> less than 1 volt at signal levels; less than 1.5 volts at full load <b>OFF-state leakage current:</b> less than 1 µA
Response Time	100 milliseconds ON/OFF	
Output Protection	All models protected against false pulse on power-up; Models with solid-state outputs have overload and short circuit protection	
Indicators	<b>Two Red indicator LEDs:</b> one lights whenever power is applied; the other lights whenever the switch is activated making the normally-open (NO) output conduct	
Construction	Totally encapsulated, non-metallic enclosure. Black polysulfone or red polycarbonate upper housing (see Application Notes below); fiber-reinforced thermoplastic polyester base. Electronics fully epoxy-encapsulated. Supplied with a field cover of polypropylene (TP).	
Environmental Rating	Meets NEMA standards 1, 3, 4, 4X, 12 and 13; IEC IP66	
Ambient Light Immunity	120,000 lux (direct sunlight)	
EMI/RFI Immunity	Immune to both single and mixed EMI and RFI noise sources	
Operating Conditions	<b>Temperature:</b> -20 to +50 °C <b>Relative humidity:</b> 90% at 50 °C (non-condensing)	
Application Notes	<b>Environmental considerations for models with polysulfone upper housings:</b> The polysulfone upper housing will become embrittled with prolonged exposure to outdoor sunlight. Window glass effectively filters longer wavelength ultraviolet light and provides excellent protection from sunlight.  <b>Environmental considerations for models with polycarbonate upper housings:</b> Avoid prolonged exposure to hot water and moist high-temperature environments above 66 °C. Avoid contact with aromatic hydrocarbons (such as xylene and toluene), halogenated hydrocarbons and strong alkalis. Clean periodically using mild soap solution and a soft cloth. Avoid strong alkaline materials.	

Certifications



# VTB Series

## Optical Touch Buttons



- Illuminated version of the Optical Touch Button
- Ergonomic design eliminates hand, wrist and arm stress
- Provides bright, easy-to-see status indication that can be seen in almost any environment
- One- and two-color models available
- 30 mm threaded base for convenient mounting

### VTB One- or Two Color

Example Model Number: VTBP6RQ

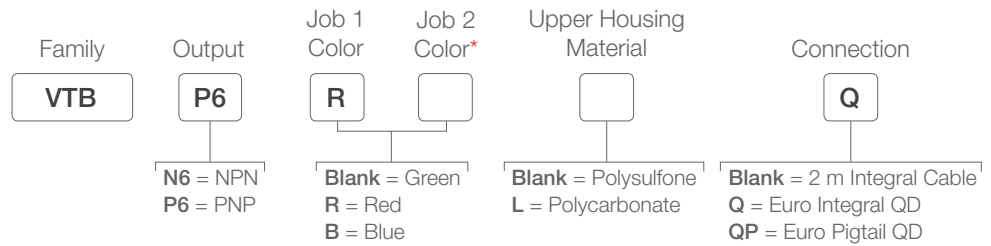

\* Leave Job Color 2 blank for one-color model

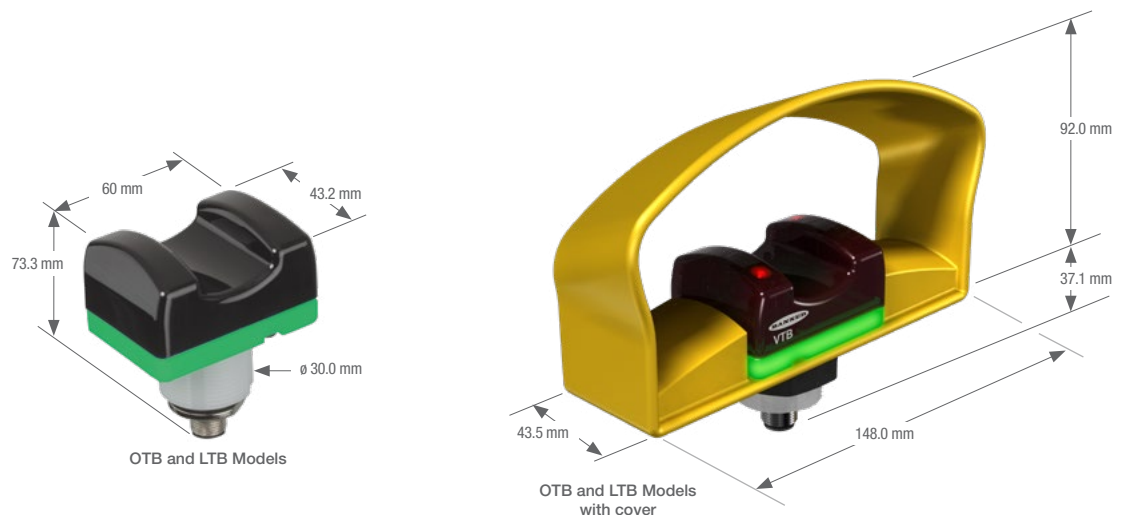

Connection Option: A model with a QD requires a mating cordset.



**Euro-Style**  
Straight connector models listed; for right-angle, add **RA** to the end of the model number (example, **MQDC-406RA**)

**4-Pin**  
**MQDC-406**  
2 m (6.5')  
**MQDC-415**  
5 m (15')  
**MQDC-430**  
9 m (30')

*Additional cordset information is available.  
See page 758*



SMB30FA



SMB30MM

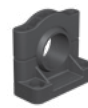

SMB30SC

*Additional bracket information is available.  
See page 728*

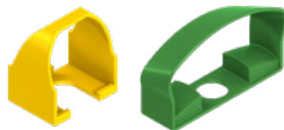

Field Covers

<b>OTC-1-BK</b> Black	<b>OTCL-1-BK</b> Black
<b>OTC-1-GN</b> Green	<b>OTCL-1-GN</b> Green
<b>OTC-1-RD</b> Red	<b>OTCL-1-RD</b> Red
<b>OTC-1-YW</b> Yellow	<b>OTCL-1-YW</b> Yellow

## VTB Specifications

<b>Supply Voltage and Current</b>	12 to 30 V dc (10% max. ripple) <b>Single-color models:</b> Less than 120 mA max. current @ 12 V dc (exclusive of load) Less than 70 mA max. current @ 30 V dc (exclusive of load) <b>Two-color models:</b> Less than 67 mA max. current @ 12 V dc (exclusive of load) Less than 40 mA max. current @ 24 V dc (exclusive of load) Less than 35 mA max. current @ 30 V dc (exclusive of load)
<b>Supply Protection Circuitry</b>	Protected against transient voltages (fast-transient and over-voltage) and reverse polarity
<b>Output Configuration</b>	Choose 1 current sinking (NPN) open collector transistor or 1 current sourcing (PNP) open collector transistor, depending on model
<b>Output Rating</b>	<b>Max. load:</b> 150 mA <b>ON-state saturation voltage:</b> less than 1.5 V @ 150 mA <b>OFF-state leakage current:</b> less than 10 $\mu$ A
<b>Output Protection</b>	All models protected against false pulse on power-up (outputs held OFF for 1 second at power-up). Models with solid-state outputs have overload and short-circuit protection.
<b>Response Time</b>	100 milliseconds ON/OFF
<b>Indicators</b>	<b>2 Red LED indicators:</b> Power ON and Output Conducting <b>Base:</b> Lights green, red, blue, or green and red as a job light when input line is enabled. One-color models may be wired for flashing rather than solid color operation.
<b>Construction</b>	Totally encapsulated, non-metallic enclosure. Black polysulfone or red polycarbonate upper housing (see Application Note); translucent white polycarbonate base. Electronics fully epoxy-encapsulated.
<b>Environmental Rating</b>	IEC IP66 ; NEMA 1, 3, 4, 4X, 12
<b>Connections</b>	2 m or 9 m attached cable, or 4-pin (single color) or 5-pin (two color) Euro-style QD fitting. QD cordsets are ordered separately.
<b>Ambient Light Immunity</b>	Up to 120,000 lux (direct sunlight)
<b>EMI/RFI Immunity</b>	Immune to EMI and RFI noise sources, per IEC 947-5-2.
<b>Operating Conditions</b>	<b>Temperature:</b> -20° to +50° C <b>Relative humidity:</b> 90% @ +50° C (non-condensing)
<b>Certifications</b>	



---

## Pick-to-Light

Banner offers the most extensive line of light-guided assembly solutions. Pick-to-Light products have unique, rugged packages with a choice of verification functions and are easy to mount for quick installation.

Series	Description	Number of Colors	Dimensions H x W x D	Power Supply	Communication
	<b>K30</b> A versatile family that combines a small, bright indicator with solid-state switching capability activated by a simple touch. page 484	1 to 3 (9 color options)	ø 22 mm base with ø 30 mm light	12 to 30 V dc	NA
	<b>K50</b> A versatile family that combines a large, bright indicator with solid-state switching capability activated by a simple touch. page 486	1 to 3 (9 color options)	ø 30 mm base with ø 50 mm light	12 to 30 V dc	Modbus Option
	<b>K70</b> A versatile family that combines a large, bright indicator with solid-state switching capability activated by a simple touch. page 488	1 to 3 (5 color options)	ø 30 mm base with ø 70 mm light	12 to 30 V dc	Wireless Option
	<b>K50</b> A reliable photoelectric sensing for non-contact part-picking applications. page 490	1 or 3 (9 color options)	ø 30 mm base with ø 50 mm light	12 to 30 V dc	Modbus Option
	<b>K30, K50 &amp; K80 Push Buttons</b> 30 or 50 mm translucent dome containing one to three colored lights and a push button. page 492	1 to 3 (9 color options)	<b>K30:</b> ø 22 mm base with ø 30 mm light <b>K50:</b> ø 30 mm base with ø 50 mm light <b>K80:</b> 80 mm housing with ø 50 mm light	12 to 30 V dc	NA
	<b>VTB</b> Features a brightly illuminated base for enhanced visual indication. page 494	1 (3 color options)	57 x 60 43 mm	12 to 30 V dc	NA
	<b>PVD</b> A compact, one-piece solutions useful in many part assembly, pick-to-light and error-proofing applications. page 496	2	H (137.8 or 266.4) 30 x 16.4 mm	12 to 30 V dc	NA
	<b>PVL</b> A retroreflective sensor that offers a reliable, cost-effective solution for bin-picking processes. page 498	2	H (225 or 500) 32.9 x 37.3 mm	12 to 30 V dc	NA
	<b>PVA</b> Helps reduce missed and misassembled parts for increased quality and reduced production costs. page 500	1	H (varies by model) 30 x 15 mm	12 to 30 V dc	NA

# K30 Touch Series

## Pick-to-Light Sensor



- Ergonomic design requires no physical pressure to operate, preventing stress on hands and wrists
- Rugged indicator with 22 mm threaded base to fit into industry standard punched holes making it ideal for error proofing of bin-picking and parts-verification applications
- Simple operation with the touch of a finger, hand or whole palm with or without gloves
- One- and two-color models available with a variety of colors and option of custom laser surface marking
- Rugged, water-resistant IP69K housing
- Excellent immunity to false triggering by water spray, detergents, oils, and other foreign materials

### K30 Touch One or Two Color,

Example Model Number: K30APT2GRDQ

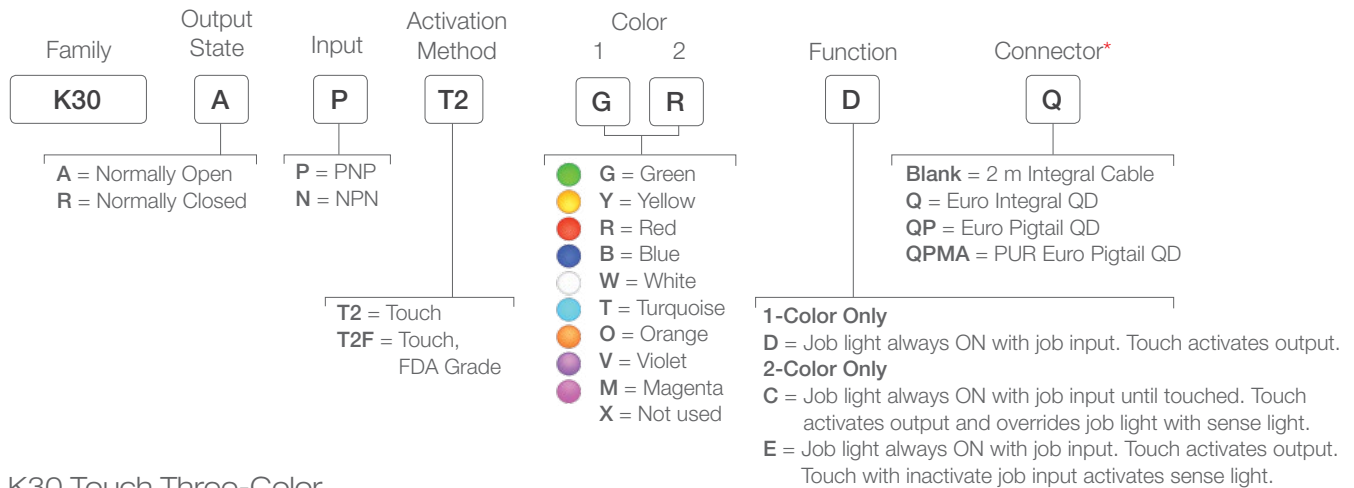

\* FDA Grade models only available with pigtail QD

### K30 Touch Three-Color

Example Model Number: K30APTGRYC4Q



\* FDA Grade models only available with pigtail QD

Connection options: A model with a QD requires a mating cordset.



4-Pin

**Euro-Style**

Straight connector models listed;  
for right-angle, add **RA** to the end  
of the model number (example,  
**MQDC-406RA**)

**MQDC-406**

2 m (6.5')

**MQDC-415**

5 m (15')

**MQDC-430**

9 m (30')



SMB22A



SMB22FVK



SMBAMS22P



SMB22RAVK

*Additional cordset information is available.  
See page 758*



*Additional bracket information is available.  
See page 727*



K30

K30 with Food-Grade  
Housing

## K30 Touch Specifications

Supply Voltage	12 to 30 V dc
Supply Current	55 mA max current (exclusive of load)
Supply Protection Circuitry	Protected against reverse polarity and transient voltages
Construction	<b>Housing:</b> Polycarbonate or FDA Grade Polycarbonate, depending on model <b>Translucent dome:</b> Polycarbonate or FDA Grade Polycarbonate, depending on model <b>Mounting Nut:</b> PBT
Environmental Rating	<b>Standard:</b> UL Type 4x, 13 <b>FDA Grade:</b> UL Type 4x IEC IP67, IP69K per DIN 40050-9 Cabled models also meet IP69K if the cable and cable entrance are protected from high-pressure spray
Connections	Integral 4-pin Euro style QD, or 2m PVC integral cable
Operating Conditions	<b>Temperature:</b> -40 to +50 °C <b>Max. Relative Humidity:</b> 90% @ +50 °C max. relative humidity (non-condensing) <b>Storage Temperature:</b> -40 to +70 °C
Certifications	 

# K50 Touch

## Pick-to-Light Sensor



- Easy-to-use lighted touch button indicators allow for increased productivity with highly visible indication.
- Ergonomic design requires no physical pressure to operate, preventing stress on hands and wrists
- Ideal for efficient pick-to-light applications where a rugged device is needed
- Simple operation with the touch of a finger, hand or whole palm with or without gloves
- Excellent immunity to false triggering by water spray, detergents, oils, and other foreign materials
- One-, two- and three-color models available with a variety of colors and option of custom laser surface marking
- Rugged, water-resistant IP69K housing

### K50 Touch One- or Two-Color

Example Model Number: K50APT2GRCQ

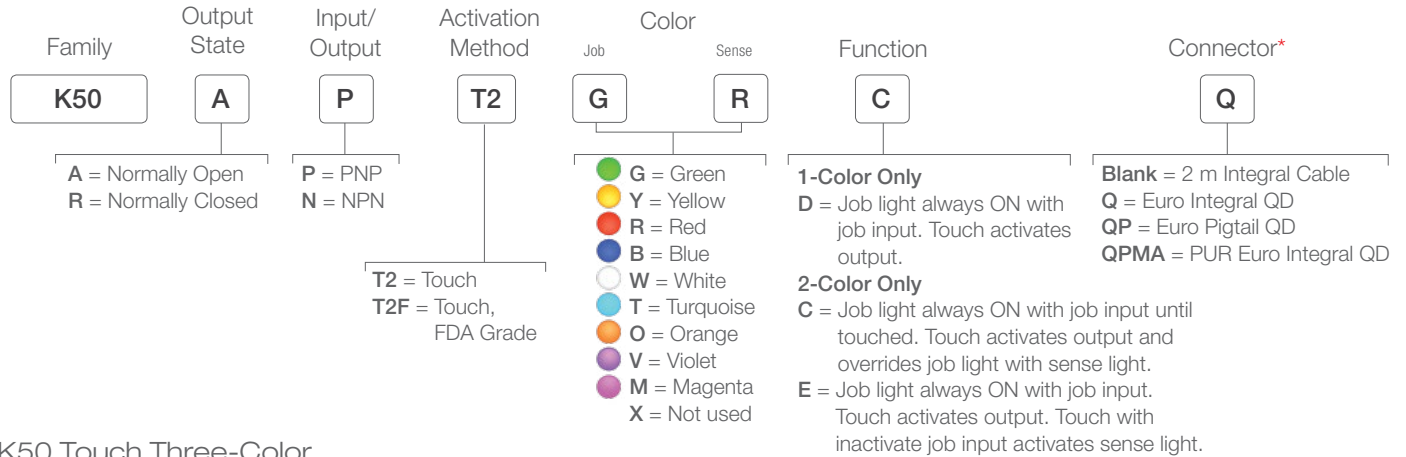

### K50 Touch Three-Color

Example Model Number: K50APT2GRYC4Q

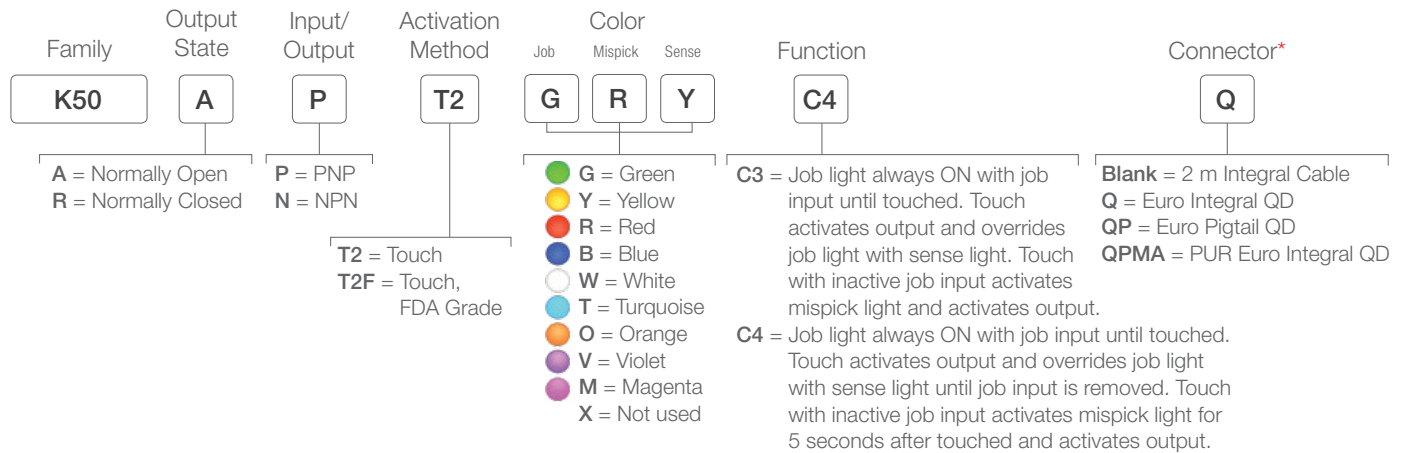

\* FDA Grade models only available with pigtail QD

\* FDA Grade models only available with pigtail QD

Connection options: A model with a QD requires a mating cordset.





5-Pin

**Euro-Style**

Straight connector models listed;  
for right-angle, add **RA** to the end  
of the model number (example,  
**MQDC1-506RA**)

**MQDC1-506**  
2 m (6.5')  
**MQDC1-515**  
5 m (15')  
**MQDC1-530**  
9 m (30')



SMB30A



SMB30MM

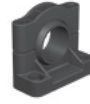

SMB30SC

Additional cordset information is available.  
See page 758

Additional bracket information is available.  
See page 727

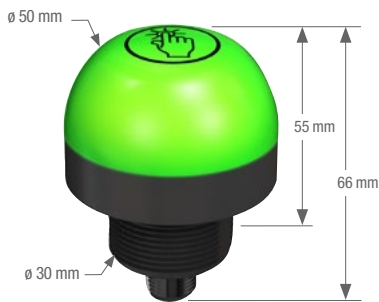



K50

K50 with Food-Grade  
Housing

Custom laser marking available

## K50 Touch Specifications

Supply Voltage	12 to 30 V dc
Supply Current	Less than 75 mA max current at 12 V dc (exclusive of load) Less than 50 mA max current at 30 V dc (exclusive of load)
Supply Protection Circuitry	Protected against reverse polarity and transient voltages (fast transient and over-voltage) and reverse polarity
Construction	<b>Housing:</b> Polycarbonate or FDA Grade Polycarbonate, depending on model <b>Translucent dome:</b> Polycarbonate or FDA Grade Polycarbonate, depending on model <b>Mounting Nut:</b> PBT
Environmental Rating	<b>Standard:</b> UL Type 4x, 13 <b>FDA Grade:</b> UL Type 4x IEC IP67, IP69K per DIN 40050-9 Cabled models also meet IP69K if the cable and cable entrance are protected from high-pressure spray
Connections	Integral 5-pin Euro style QD, or 2 m PVC integral cable, or 5-pin 150 mm Euro-style PVC pigtail QD
Operating Conditions	<b>Temperature:</b> -40 to +50 °C <b>Max. Relative Humidity:</b> 90% @ +50 °C max. relative humidity (non-condensing) <b>Storage Temperature:</b> -40 to +70 °C
Certifications	 

# K70 Touch Series

## Pick-to-Light Sensor



- Excellent immunity to false triggering by water spray, detergents, oils, and other foreign materials
- Ergonomically designed to eliminate hand, wrist, and arm stresses associated with repeated switch operation; require no physical force to operate
- Can be actuated with bare hands or in gloves
- Rugged IP65 polycarbonate construction
- Momentary versions remain activated as long as touch is present
- Latching versions start up not activated and toggle between activated and not activated on successive touches
- Available in nine color options and one-, two- and three-color models

### K70 Pick-to-Light

Example Model Number: K70APT2GXDQ

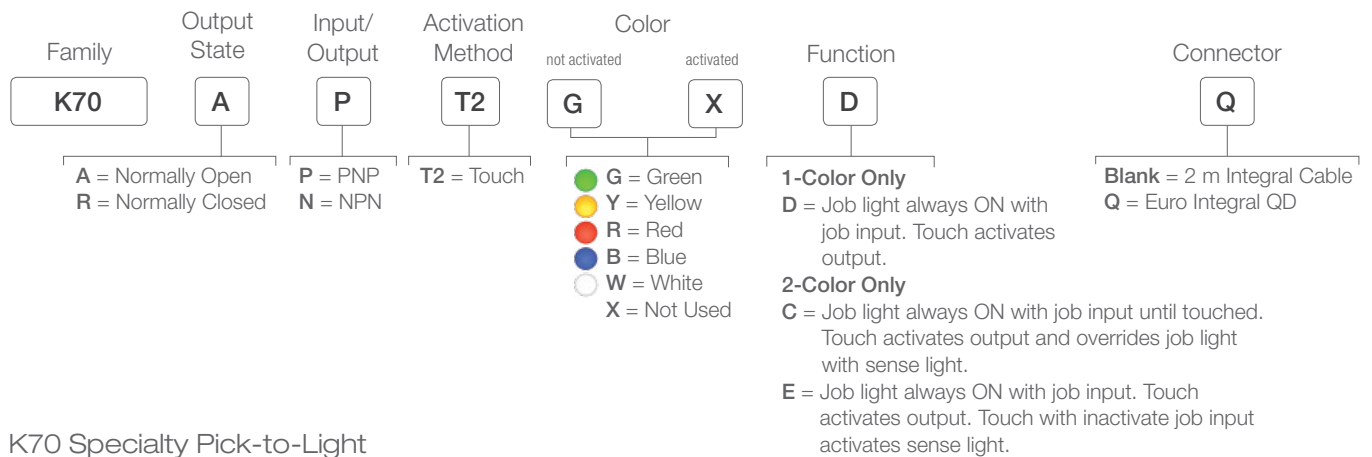

### K70 Specialty Pick-to-Light

Example Model Number: K70APT2GRYC4Q



Connection Option: A model with a QD requires a mating cordset.



4-Pin

**Euro-Style**

Straight connector models listed;  
for right-angle, add **RA** to the end  
of the model number (example,  
**MQDC-406RA**)

**MQDC-406**  
2 m (6.5')  
**MQDC-415**  
5 m (15')  
**MQDC-430**  
9 m (30')

*Additional cordset information is available.  
See page 758*



SMB30A



SMB30MM



SMBAMS30P





SSA-MBK-EEC1

*Additional bracket information is available.  
See page 727*



## K70 Touch Specifications

Supply Voltage	12 to 30 V dc
Supply Current	< 220 mA maximum current at 12 V dc < 110 mA maximum current at 30 V dc
Supply Protection Circuitry	Protected against reverse polarity and transient voltages
Construction	<b>Housing:</b> Polycarbonate <b>Translucent dome:</b> Polycarbonate <b>Mounting Nut:</b> PBT
Environmental Rating	IEC IP65
Connections	Integral 5-pin Euro style QD, or 2 m PVC integral cable, or 5-pin 150 mm Euro-style PVC pigtail QD
Operating Conditions	<b>Temperature:</b> -40 to +50 °C <b>Max. Relative Humidity:</b> 95% @ +50 °C max. relative humidity (non-condensing)
Certifications	 

# K50 Optical Series

## Pick-to-Light Sensor



- The K50FF and K50LP use reliable photoelectric sensing for non-contact part-picking applications.
- Photoelectric pick acknowledgment
- Fixed-field or polarized retroreflective depending on model
- Simple, one-piece, cost-effective installations
- Easily mounted on any type of tube rack or shelving
- Several logic functions available to customize the operation of the application and control system

### K50 One- or Two-Color

Example Model Number: K50APLPGXD

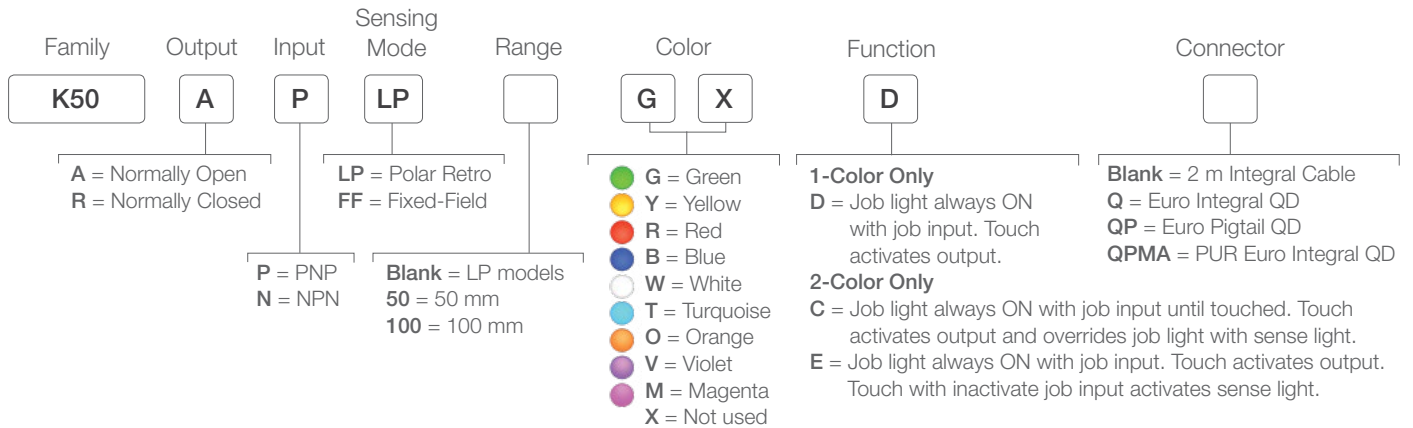

### K50 Three-Color

Example Model Number: K50APLPGRYC3QPMA

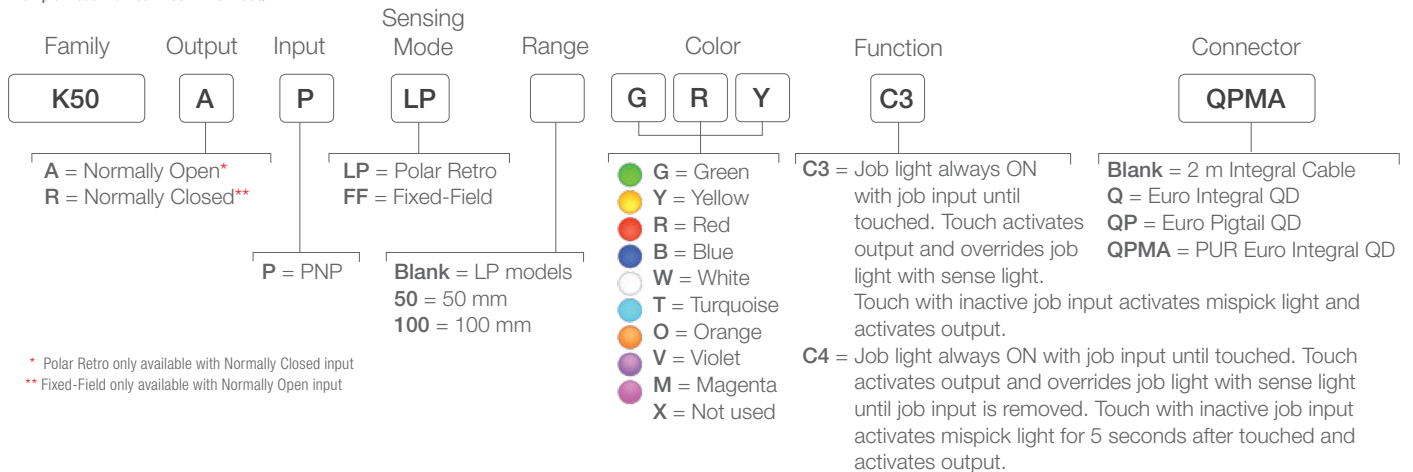

Connection options: A model with a QD requires a mating cordset.

**Euro-Style**

Straight connector models listed; for right-angle, add **RA** to the end of the model number (example, **MQDC-406RA**)

**4-Pin**

**MQDC-406**  
2 m (6.5')  
**MQDC-415**  
5 m (15')  
**MQDC-430**  
9 m (30')

**5-Pin**

**MQDC-506**  
2 m (6.5')  
**MQDC-515**  
5 m (15')  
**MQDC-530**  
9 m (30')

Additional cordset information is available.  
See page 758

**Reflectors**

Additional information is available  
See page 790



**SMB30A****SMB30FA..****SMB30RAVK**

Additional bracket information is available.  
See page 727

**Andon Rope Pull Brackets**

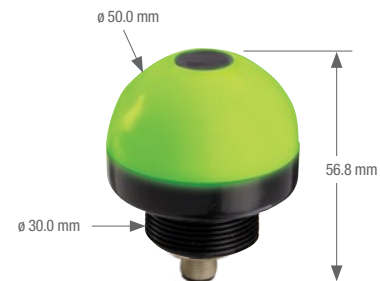
**SMBARPL30**  
(Left Side)  
**SMBARPR30**  
(Right Side)  
**SMBARPB30**  
(Both Sides)

**K50 Specifications**

<b>Supply Voltage and Current</b>	12 to 30 V dc, (10% max. ripple)
<b>Supply Protection Circuitry</b>	Protected against reverse polarity and transient voltages (fast transient and over-voltage) and reverse polarity
<b>Output Configuration</b>	PNP or NPN (depending on model)
<b>Output Rating</b>	150 mA max. <b>C3 and C4 models: ON-state saturation voltage: PNP models:</b> Less than 2 V @ 10 mA dc; less than 2.5 V @ 150 mA dc <b>NPN models:</b> Less than 1.5 V @ 10 mA dc; less than 2 V @ 150 mA dc <b>OFF-state leakage current:</b> Less than 10 µA @ 30 V dc <b>All others: OFF-state leakage current:</b> Less than 10 µA @ 30 V dc <b>ON-state voltage:</b> less than 2 V @ 10 mA dc; less than 2.5 V @ 150 mA dc
<b>Output Protection Circuitry</b>	Protected against false pulse on power-up and continuous overload or short circuit of output
<b>Output Response Time</b>	<b>C3 and C4 models:</b> 5 milliseconds ON/OFF <b>All others:</b> 3 milliseconds ON/OFF
<b>Indicators</b>	<b>C3 models:</b> Entire translucent dome provides indicator light. Job ("Pick") indicator–Green      Pick Sensed indicator–Yellow      Mispick indicator–Red <b>All others:</b> Entire translucent dome provides indicator light; either Job or Pick Sensed indicator inhibits the other light, depending on model. Job ("Pick") indicator–Green      Pick Sensed indicator–Red or OFF, depending on model
<b>Job Light Enable Input</b>	Input impedance: 8000Ω Sinking–Input low less than 1.5 V    Sourcing–Input high greater than 7 V
<b>Construction</b>	<b>Base and translucent dome:</b> Polycarbonate <b>Lens:</b> Polycarbonate or acrylic <b>Push Button:</b> Thermoplastic
<b>Environmental Rating</b>	Fully encapsulated; IEC IP67 <b>Integral QD models:</b> IP69K when using IP69K-rated cordsets <b>Pigtail and cable models:</b> IP69K when mounted with conduit
<b>Connections</b>	<b>C3 and C4 models:</b> 5-pin 150 mm PUR pigtail Euro-style QD (QPMA). QD cordsets are ordered separately. <b>All others:</b> 2 m or 9 m 4-wire attached cable, 4-pin integral Euro-style QD (Q) or 4-pin 150 mm PVC pigtail Euro-style QD (QP), depending on model QD cordsets are ordered separately.
<b>Ambient Light Immunity</b>	Up to 5,000 lux
<b>EMI/RFI Immunity</b>	Immunity to EMI and RFI noise sources per IEC 947-5-2
<b>Operating Conditions</b>	<b>Temperature:</b> –40 to +50 °C <b>Relative Humidity:</b> 90% at 50 °C (non-condensing)
<b>Certifications</b>	 

# K30, K50 & K80

## Pick-to-Light Push Button



- Requires no external controller to operate; completely self-contained
- Indicates job pick status with 30 & 50 mm translucent dome containing one, two or three colored lights
- Shows correct order for selecting parts using a green job light in all models
- Models available with a red light to indicate detection of operator action or mispick
- Models available with 30 mm, Flat or DIN-rail mounting
- Ideal for use in abusive environments—fully encapsulated IP67 construction; some models rated to IP69K depending on installation
- QPMA model options also available

### K30, K50, K80 One- or Two-Color

Example Model Number: K30APBGGXD

- Job light is ON at all times while job input is active.
- Pressing push button initiates output change of state.

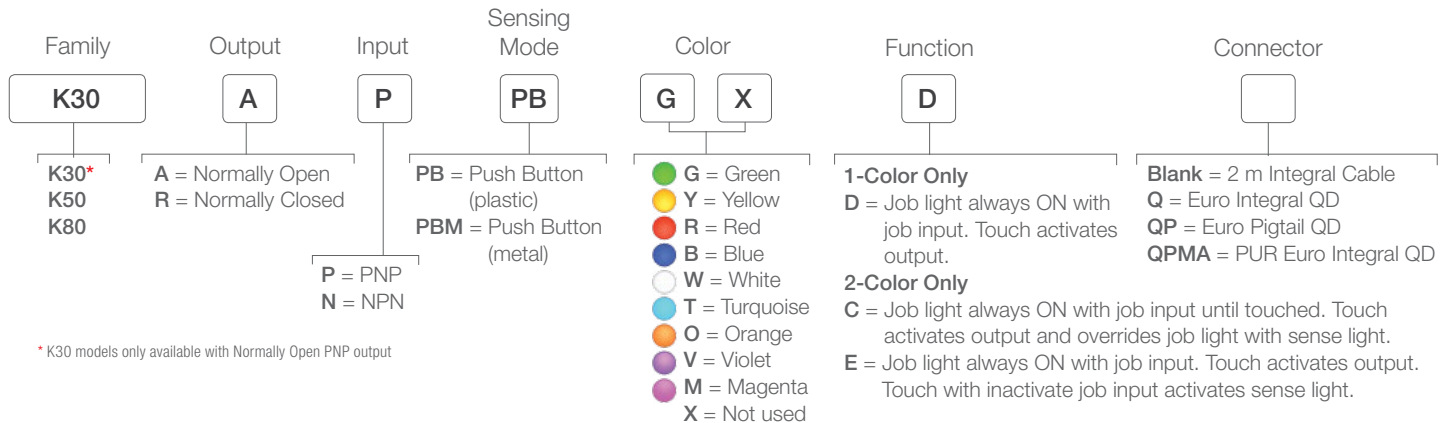

### K50 and K80 Three-Color C-Series

Example Model Number: K50APLPGRYC#QPMA

- Job light is ON at all times while job input is active (unless hand is present)
- Presence of hand (or pressing button) activates output and turns job light Yellow for visual verification that action was sensed
- Presence of hand (or pressing button) while job input is not active turns light Red signaling mispick



Connection options: A model with a QD requires a mating cordset.

**Euro-Style**

Straight connector models listed; for right-angle, add **RA** to the end of the model number (example, **MQDC-406RA**)

**4-Pin**

**MQDC-406**  
2 m (6.5')  
**MQDC-415**  
5 m (15')  
**MQDC-430**  
9 m (30')

**5-Pin**

**MQDC-506**  
2 m (6.5')  
**MQDC-515**  
5 m (15')  
**MQDC-530**  
9 m (30')

Additional cordset information is available.  
See page 758

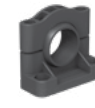
**K50****K30****SMB30A****SMB30FA..****SMB30SC****SMB22A**

Additional bracket information is available.  
See page 727

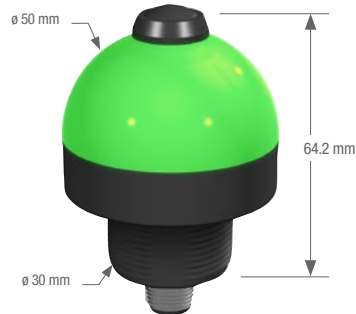
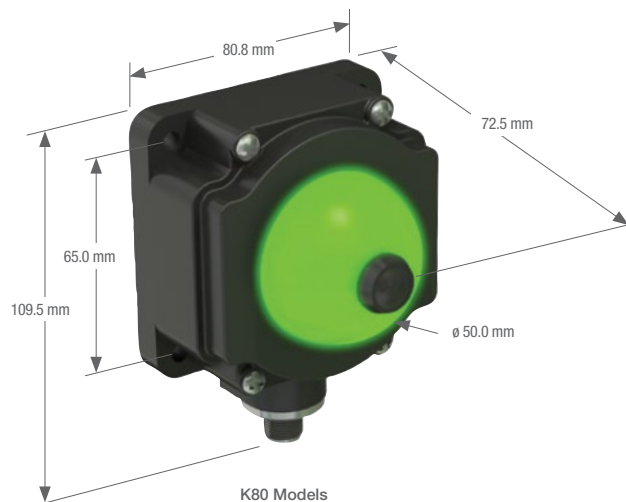
**K30 Push Models****K50 Push Models****K80 Models****K30, K50 & K80 Specifications**

<b>Supply Voltage and Current</b>	12 to 30 V dc, (10% max. ripple)
<b>Supply Protection Circuitry</b>	Protected against reverse polarity and transient voltages (fast transient and over-voltage) and reverse polarity
<b>Output Configuration</b>	PNP or NPN (depending on model)
<b>Output Rating</b>	150 mA max. <b>C3 models:</b> <b>ON-state saturation voltage:</b> <b>PNP models:</b> Less than 2 V @ 10 mA dc; less than 2.5 V @ 150 mA dc <b>NPN models:</b> Less than 1.5 V @ 10 mA dc; less than 2 V @ 150 mA dc <b>OFF-state leakage current:</b> Less than 10 µA @ 30 V dc <b>All others:</b> <b>OFF-state leakage current:</b> Less than 10 µA @ 30 V dc <b>ON-state voltage:</b> less than 2 V @ 10 mA dc; less than 2.5 V @ 150 mA dc
<b>Output Protection Circuitry</b>	Protected against false pulse on power-up and continuous overload or short circuit of output
<b>Output Response Time</b>	<b>C3 and C4 models:</b> 5 milliseconds ON/OFF <b>All others:</b> 3 milliseconds ON/OFF
<b>Indicators</b>	<b>C3 and C4 models:</b> Entire translucent dome provides indicator light. Job ("Pick") indicator–Green Pick Sensed indicator–Yellow Mispick indicator–Red <b>All others:</b> Entire translucent dome provides indicator light; either Job or Pick Sensed indicator inhibits the other light, depending on model. Job ("Pick") indicator–Green Pick Sensed indicator–Red or OFF, depending on model
<b>Job Light Enable Input</b>	<b>Input impedance:</b> 8000Ω Sinking–Input low less than 1.5 V Sourcing–Input high greater than 7 V
<b>Construction</b>	<b>Base and translucent dome:</b> polycarbonate <b>Lens:</b> polycarbonate or acrylic <b>Push Button:</b> thermoplastic or stainless steel
<b>Environmental Rating</b>	Fully encapsulated; IEC IP67 <b>Integral QD models:</b> IP69K when using IP69K-rated cordsets <b>Pigtail and cable models:</b> IP69K when mounted with conduit
<b>Connections</b>	<b>C3 and C4 models:</b> Integral 5-pin Euro style QD, or 2 m PVC integral cable, 5-pin 150 mm Euro-style PVC pigtail QD, or 150 mm PUR pigtail Euro-style QD (QPMA). <b>All others:</b> 2 m or 9 m 4-wire attached cable, 4-pin integral Euro-style QD (Q) or 4-pin 150 mm PVC pigtail Euro-style QD (QP), depending on model.
<b>Ambient Light Immunity</b>	Up to 5,000 lux
<b>EMI/RFI Immunity</b>	Immunity to EMI and RFI noise sources per IEC 947-5-2
<b>Operating Conditions</b>	<b>Temperature:</b> –40 to +50 °C <b>Relative Humidity:</b> 90% at 50 °C (non-condensing)

**Certifications**

# VTB Series

## Optical Touch Buttons



- Illuminated version of the Optical Touch Button
- Ergonomic design eliminates hand, wrist and arm stress
- Provides bright, easy-to-see status indication that can be seen in almost any environment
- One- and two-color models available
- 30 mm threaded base for convenient mounting

### VTB One- or Two Color

Example Model Number: VTBP6RQ

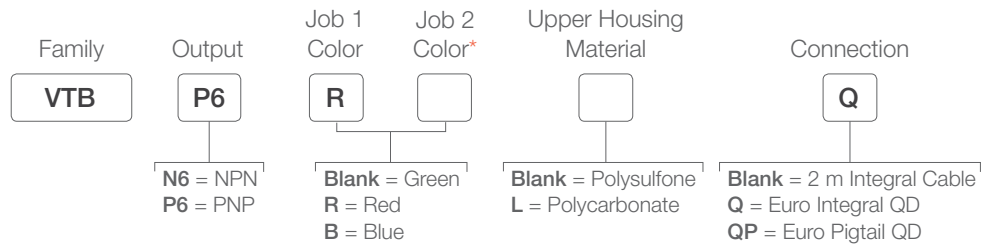

\* Leave Job 2 color box empty for a one color model

 Connection Option: A model with a QD requires a mating cordset.





4-Pin

**Euro-Style**

Straight connector models listed; for right-angle, add **RA** to the end of the model number (example, **MQDC-406RA**)

**MQDC-406**  
2 m (6.5')  
**MQDC-415**  
5 m (15')  
**MQDC-430**  
9 m (30')

Additional cordset information is available.  
See page 758



SMB30FA



SMB30MM

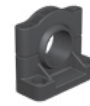

SMB30SC

Additional bracket information is available.  
See page 728



## Field Covers

**OTC-1-BK**  
Black  
**OTC-1-GN**  
Green  
**OTC-1-RD**  
Red  
**OTC-1-YW**  
Yellow

**OTCL-1-BK**  
Black  
**OTCL-1-GN**  
Green  
**OTCL-1-RD**  
Red  
**OTCL-1-YW**  
Yellow

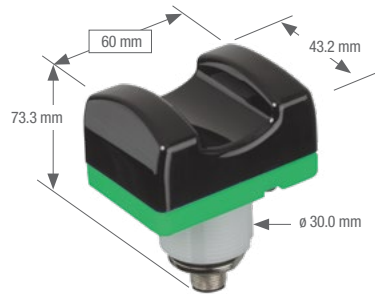

## VTB Specifications

Supply Voltage and Current	12 to 30 V dc (10% max. ripple) <b>Single-color models:</b> Less than 120 mA max. current @ 12 V dc (exclusive of load) Less than 70 mA max. current @ 30 V dc (exclusive of load) <b>Two-color models:</b> Less than 67 mA max. current @ 12 V dc (exclusive of load) Less than 40 mA max. current @ 24 V dc (exclusive of load) Less than 35 mA max. current @ 30 V dc (exclusive of load)
Supply Protection Circuitry	Protected against transient voltages (fast-transient and over-voltage) and reverse polarity
Output Configuration	Choose 1 current sinking (NPN) open collector transistor or 1 current sourcing (PNP) open collector transistor, depending on model
Output Rating	<b>Max. load:</b> 150 mA <b>ON-state saturation voltage:</b> less than 1.5 V @ 150 mA <b>OFF-state leakage current:</b> less than 10 µA
Output Protection	All models protected against false pulse on power-up (outputs held OFF for 1 second at power-up). Models with solid-state outputs have overload and short-circuit protection.
Response Time	100 milliseconds ON/OFF
Indicators	<b>2 Red LED indicators:</b> Power ON and Output Conducting <b>Base:</b> Lights green, red, blue, or green and red as a job light when input line is enabled. One-color models may be wired for flashing rather than solid color operation.
Construction	Totally encapsulated, non-metallic enclosure. Black polysulfone or red polycarbonate upper housing (see Application Note); translucent white polycarbonate base. Electronics fully epoxy-encapsulated.
Environmental Rating	IEC IP66 ; NEMA 1, 3, 4, 4X, 12
Connections	2 m or 9 m attached cable, or 4-pin (single color) or 5-pin (two color) Euro-style QD fitting. QD cordsets are ordered separately.
Ambient Light Immunity	Up to 120,000 lux (direct sunlight)
EMI/RFI Immunity	Immune to EMI and RFI noise sources, per IEC 947-5-2.
Operating Conditions	<b>Temperature:</b> -20 to +50 °C <b>Relative humidity:</b> 90% @ +50 °C (non-condensing)

## Certifications



# PVD Series

## Parts Verification Array



- Compact, one-piece solution useful in many part assembly, pick-to-light and error-proofing applications
- Innovative, low-profile design with auto-configuration feature for diffuse or retroreflective modes
- Ideal for bin picking in tube rack or shelving applications
- Green light for pick and red light for misspick with selectable control features
- Rugged housing for high durability
- Protective mounting brackets available

### PVD

Example Model Number: PVD100Q

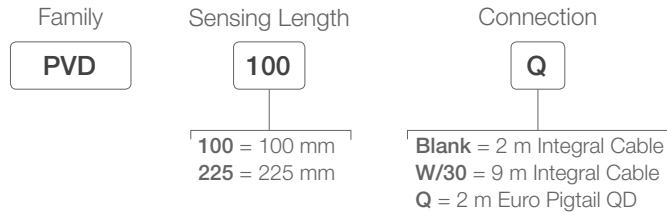

NOTE: Green job light to indicate user action



Length (L)	Models
137.8 mm	PVD100
266.4 mm	PVD225

Connection options: A model with a QD requires a mating cordset.



## 5-Pin

## Euro-Style

Straight connector models listed; for right-angle, add **RA** to the end of the model number (example, **MQDC1-506RA**)

**MQDC1-506**  
2 m (6.5')  
**MQDC1-515**  
5 m (15')  
**MQDC1-530**  
9 m (30')



SMBPVD...



SMBPVA..C



SMBPVA6

## Reflectors



Additional cordset information is available.  
See page 758

Additional bracket information is available.  
See page 728

Additional information is available  
See page 790

## PVD Specifications

Sensing Range	<b>Retroreflective applications:</b> 2 m, using 25 mm wide retroreflective tape <b>Diffuse applications:</b> 400 mm, with 18% reflectivity gray card target
Sensing Beam	630 nm, Visible red
Beam Spacing	28.6 mm
Sensing Height	<b>4-channel models:</b> 111 mm <b>8-channel models:</b> 240 mm
Supply Voltage and Current	<b>Input Voltage:</b> 12 to 30 V dc (10% max. ripple @ 10% duty cycle) <b>Input Current:</b> less than 40 mA @ 24 V dc and less than 70 mA @ 12 V dc (exclusive of load)
Supply Protection Circuitry	Protected against reverse polarity and transient over-voltage
Sensing Resolution	<b>Retroreflective:</b> 51 mm at 406 mm range, 100 mm at 2 m <b>Diffuse:</b> 55 mm dia. at 400 mm range
Output Configuration	<b>User-selectable via DIP switch:</b> 1 open-collector PNP (current sourcing) or 1 open-collector NPN (current sinking)
Output Rating	150 mA max. <b>OFF-state leakage current:</b> less than 10 $\mu$ A <b>ON-state saturation voltage:</b> <b>NPN:</b> less than 1.0 V dc at 150 mA <b>PNP:</b> less than 2.0 V dc at 150 mA
Output Protection Circuitry	Protected against false pulse at power-up and short circuit of outputs
Output Response Time	400 milliseconds (Includes standard 100 milliseconds ON-delay and 100 milliseconds OFF-delay)
Delay at Power-Up	Less than 1.0 second
Indicators	<b>Green:</b> LED to indicate power ON/OFF <b>Yellow:</b> LED to indicate output ON/OFF <b>Job Light:</b> (Diffused Green LED) Turned ON and OFF by applying an external signal to the Job input (white wire). The job lights will be active high or active low, depending on user selection of DIP switch 4. <b>Error Light:</b> (Diffused Red LED) Turned ON and OFF by detection of an output event when job light is not ON.
Adjustments	4 DIP switches, located behind access panel (*denotes default setting): 1. PNP*/NPN output 2. Normally Open operation†/Normally Closed 3. Job light ON solid*/Job light flashing 4. Job light input high*/Job light input low
Construction	Black painted aluminum housing; acrylic lenses; thermoplastic polyester end caps; thermoplastic elastomer programming switch cover; stainless steel mounting brackets and hardware
Environmental Rating	NEMA 2; IEC IP62
Connections	5-conductor PVC-jacketed 2 m cable which is either unterminated or terminated with a 5-pin Euro-style quick-disconnect connector, depending on model. Cable diameter is 3.3 mm. QD cordsets are ordered separately.
Operating Conditions	<b>Temperature:</b> 0° to +50° C <b>Relative humidity:</b> 90% relative humidity @ 50° C (non-condensing)
Certifications	

# PVL Series

## Parts Verification Array



- Compact, one-piece solution useful in many part assembly, pick-to-light and error-proofing applications
- Innovative, low-profile design with auto-configuration feature for diffuse or retroreflective modes
- Ideal for bin picking in tube rack or shelving applications
- Green light for pick and red light for misspick with selectable control features
- Rugged housing for high durability
- Protective mounting brackets available

### PVL

Example Model Number: PVL225PQ

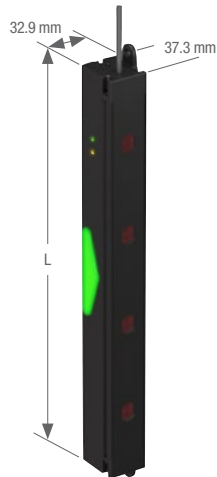
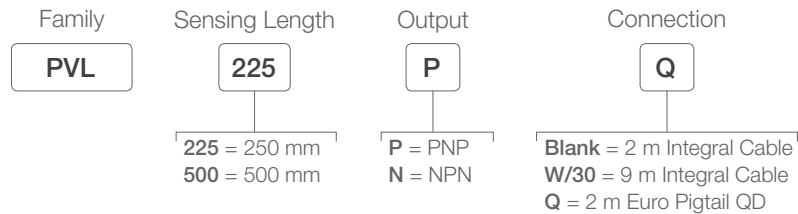

Length (L)	Models
327.5 mm	PVL225
608 mm	PVL500

Connection options: A model with a QD requires a mating cordset.

**Euro-Style**

Straight connector models listed; for right-angle, add **RA** to the end of the model number (example, **MQDC-406RA**)

**4-Pin**

**MQDC-406**  
2 m (6.5')  
**MQDC-415**  
5 m (15')  
**MQDC-430**  
9 m (30')

Additional cordset information is available.  
See page 758

**SMBPVL1****SMBPVL2-(225 or 500)****SMBPVL3-(225 or 500)****SMBPVL4****SMBPVL5**

Additional bracket information is available.  
See page 728

**Reflectors**

Additional information is available  
See page 790

**PVL Specifications**

<b>Sensing Range</b>	1.5 m, using 25 mm wide retroreflective tape
<b>Sensing Beam</b>	630 nm, Visible red
<b>Beam Spacing</b>	70 mm
<b>Supply Voltage and Current</b>	<b>Input Voltage:</b> 12 to 30 V dc (10% max. ripple) PLV225; Input Current: less than 140 mA @ 12 V dc and less than 70 mA @ 30 V dc (exclusive of load) PVL500; Input Current: less than 220 mA @ 12 V dc and less than 100 mA @ 30 V dc (exclusive of load)
<b>Supply Protection Circuitry</b>	Protected against reverse polarity and transient over-voltage
<b>Output Rating</b>	150 mA max. <b>OFF-state leakage current:</b> less than 10 $\mu$ A <b>ON-state saturation voltage:</b> <b>NPN:</b> less than 1.5 V at 10 mA dc <b>NPN:</b> less than 2.0 V at 150 mA dc <b>PNP:</b> less than 2.0 V dc at 10 mA <b>PNP:</b> less than 2.5 V dc at 150 mA
<b>Output Response Time</b>	Less than 2 milliseconds ON and OFF
<b>Delay at Power-Up</b>	Less than 1.0 second
<b>Indicators</b>	<b>Green:</b> LED to indicate power ON/OFF <b>Yellow:</b> LED to indicate output ON/OFF <b>Job Light:</b> (Diffused Green LED) Turned ON and OFF by applying an external signal to the Job input (white wire). The job lights will be active high or active low, depending on user selection of DIP switch 4. <b>Error Light:</b> (Diffused Red LED) Turned ON and OFF by detection of an output event when job light is not ON.
<b>Construction</b>	Black anodized aluminum housing, painted zinc end caps, thermoplastic front face and lenses
<b>Environmental Rating</b>	IEC IP50
<b>Connections</b>	2 m PVC-jacketed cable which is either unterminated or terminated, depending on model. QD cordsets are ordered separately.
<b>Operating Conditions</b>	<b>Temperature:</b> 0 to +50 °C <b>Relative humidity:</b> 90% relative humidity @ 50 °C (non-condensing)

Certifications



# PVA Series

## Parts Verification Array



- Help reduce missed and misassembled parts for increased quality and reduced production costs
- Highly visible job lights provides the most reliable solution for error proofing
- Emitter/receiver arrays for high resolution sensing
- Four lengths to cover a variety of openings and applications
- Highly reliable sensing over a long operating range
- Wide field-of-view makes alignment easy
- Protective mounting brackets available

### PVA

Example Model Number: PVA100P6EQ

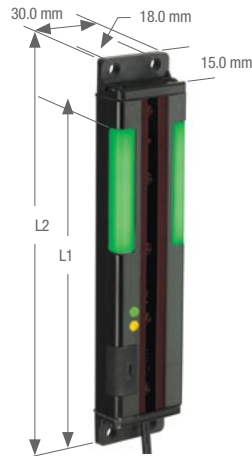
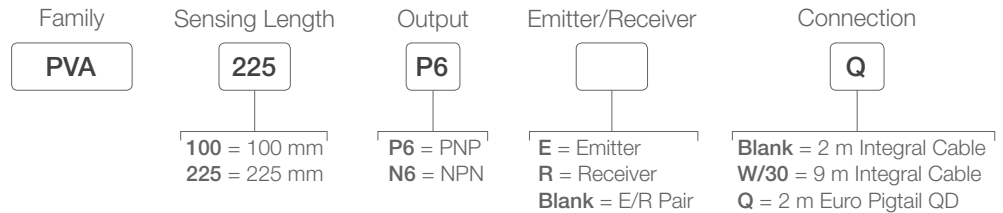

Models	No. of Beams	Length (L1)	Length (L2)
PVA100	5	100	137.8 mm
PVA225	10	225	266.4 mm
PVA300	13	300	341.4 mm
PVA375	16	375	416.6 mm

Connection options: A model with a QD requires a mating cordset.



4-Pin

**Euro-Style**

Straight connector models listed; for right-angle, add **RA** to the end of the model number (example, **MQDC-406RA**)

**MQDC-406**  
2 m (6.5')  
**MQDC-415**  
5 m (15')  
**MQDC-430**  
9 m (30')



SMBPVA...



SMBPVA..C



SMBPVA2



SMBPVA6

Additional cordset information is available.  
See page 758

Additional bracket information is available.  
See page 728

## PVA Specifications

Beam Spacing	25.0 mm		
Sensing Height	100, 225, 300 or 375 mm, depending on emitter and receiver models		
Supply Voltage and Current	12 to 30 V dc (10% max. ripple) at less than 62 mA for the emitter and 50 mA for the receiver (exclusive of load)		
Supply Protection Circuitry	Protected against reverse polarity		
Output Configuration	<b>Receivers have one solid-state dc output, programmable for Light or Dark Operate:</b> Models PVA...N6R have current sinking (NPN) open-collector transistor Models PVA...P6R have current sourcing (PNP) open-collector transistor		
Output Rating	150 mA max. <b>OFF-state leakage current:</b> less than 2 $\mu$ A <b>ON-state saturation voltage:</b> less than 1 V dc at 10 mA and less than 1.5 V dc at 100 mA		
Output Response Time	<b>Sensor Size</b>	<b>Standard</b>	<b>With Crosstalk from Adjacent Units</b>
	100 mm	20 milliseconds	30 milliseconds max.
	225 mm	40 milliseconds	60 milliseconds max.
	300 mm	52 milliseconds	78 milliseconds max.
	375 mm	64 milliseconds	96 milliseconds max.
Output Protection Circuitry	Protected against false pulse at power-up and continuous overload or short circuit of outputs		
Sensing Resolution	35 mm min. diameter		
Status Indicators	<p><b>Emitter:</b> One Green LED to indicate power ON/OFF One Red LED to indicate frequency selected</p> <p><b>Receiver:</b> One Green LED to indicate power ON/OFF One Yellow LED to indicate output state</p> <p><b>Emitter &amp; Receiver:</b> Both have two highly visible "job lights" which are turned ON/OFF by applying an external signal to the white wire. The job lights may be programmed for steady or flashing green.</p>		
Construction	Black painted aluminum housing; acrylic lenses; PBT polyester end caps; thermoplastic elastomer programming switch cover; stainless steel mounting brackets and hardware		
Environmental Rating	IEC IP62; NEMA 2		
Connections	<p><b>Emitter:</b> 3-conductor PVC-jacketed 2 m cable which is either unterminated or terminated with a 4-pin Euro-style quick-disconnect connector, depending on model. Cable diameter is 3.3 mm.</p> <p><b>Receiver:</b> 4-conductor PVC-jacketed 2 m cable which is either unterminated or terminated with a 4-pin Euro-style quick-disconnect connector, depending on model. Cable diameter is 3.3 mm.</p>		
Operating Temperature	0 to +50 °C		
Certifications			





## Wireless

Banner Engineering's SureCross wire replacement products are designed to be easy to use. The most basic network includes a Gateway and one Node. Many of these simple-to-use models include pre-defined I/O mapping between two devices.



# WIRELESS

---

SIMPLE WIRE REPLACEMENT **page 504**

WIRELESS SENSORS **page 512**

NETWORK RADIOS **page 522**

WIRELESS CONTROLLERS **page 528**

## OTHER AVAILABLE MODELS



TL70 **page 414**

# Simple Wire Replacement

Extend your range and eliminate the need for wires for the most common communication signals including discrete, analog, serial and Ethernet.

- Easy to apply, use and support
- Simple yet highly expandable
- Easy to deploy

Model	Inputs/Outputs		Inputs/Outputs	Page
PM Series	PM2: 4 selectable discrete/ 2 analog inputs 4 selectable discrete/ 2 analog outputs	Node ↔ Gateway 	PM2: 4 selectable discrete/ 2 analog inputs 4 selectable discrete/ 2 analog outputs	505
	PM8: 6 sourcing discrete inputs 6 sourcing discrete outputs		PM8: 6 sourcing discrete inputs 6 sourcing outputs	506
PB2	2 selectable discrete & 2 analog inputs 2 selectable discrete & 2 analog outputs	Node ↔ Gateway 	2 selectable discrete & 2 analog inputs 2 selectable discrete & 2 analog outputs	508
Serial Radio	RS-232 or RS-485	Slave ↔ Master 	RS-232 or RS-485	509
Ethernet Radio	Ethernet TCP/IP, RS-232 or RS-485	Slave ↔ Master 	Ethernet TCP/IP, RS-232 or RS-485	510
DXER9	Ethernet TCP/IP	Slave ↔ Master 	Ethernet TCP/IP	511

# PM2 Series

## Digital Wire Replacement



- The Sure Cross® PM Series radios easily replaces Discrete and Analog signal wires, and with no setup software needed, the radios are easy to apply, use and support.
- Simple yet highly expandable
- Eight LCD menu selectable I/O mapping options
- IP67 rated housing for use in demanding environments

### PM2 Gateway, 10-30 V DC

	Frequency	Range*	Environmental Rating	Models
<b>Inputs:</b> Four selectable discrete & Two 0-20 mA analog	900 MHz	6 miles	IP67, NEMA 6	<b>DX80G9M6S-PM2</b>
<b>Outputs:</b> Four sourcing discrete & Two 0-20 mA analog	2.4 GHz	2 miles	IP67, NEMA 6	<b>DX80G2M6S-PM2</b>

### PM2 Node, 10-30 V DC

	Frequency	Range*	Environmental Rating	Models
<b>Inputs:</b> Four selectable discrete & Two 0-20 mA analog	900 MHz	6 miles	IP67, NEMA 6	<b>DX80N9X6S-PM2</b>
<b>Outputs:</b> Four sourcing discrete & Two 0-20 mA analog	2.4 GHz	2 miles	IP67, NEMA 6	<b>DX80N2X6S-PM2</b>

### PM2 Kits (Includes PM2 Gateway & PM2 Node, 10-30 V DC)

	Frequency	Range*	Environmental Rating	Models
<b>Inputs:</b> Four selectable discrete & Two 0-20 mA analog	900 MHz	6 miles	IP67, NEMA 6	<b>DX80K9M6-PM2</b>
<b>Outputs:</b> Four sourcing discrete & Two 0-20 mA analog	2.4 GHz	2 miles	IP67, NEMA 6	<b>DX80K2M6-PM2</b>

For accessories see page 530.

\* Line of sight with included 2 dB antenna. High-gain antennas available for increased range. See accessories page 530.

# PM8 Series

## Digital Wire Replacement



- The Sure Cross® PM Series radios easily replaces Discrete and Analog signal wires, and with no setup software needed, the radios are easy to apply, use and support.
- Simple yet highly expandable
- Eight LCD menu selectable I/O mapping options
- IP67 rated housing for use in demanding environments
- One Gateway can support up to 6 nodes

### PM8 Gateway, 10-30 V DC

	Frequency	Range <sup>†</sup>	Environmental Rating	LCD Screen	Models
<b>Inputs:</b> Six sourcing discrete <b>Outputs:</b> Six sourcing discrete	900 MHz	6 miles	IP67, NEMA 6	Yes	DX80G9X6S-PM8
	2.4 GHz	2 miles	IP67, NEMA 6	Yes	DX80G2M6S-PM8

### PM8 Node, 10-30 V DC

	Frequency	Range <sup>†</sup>	Environmental Rating	LCD Screen	Models
<b>Inputs:</b> Six sourcing discrete <b>Outputs:</b> Six sourcing discrete	900 MHz*	6 miles	IP67, NEMA 6	Yes	DX80N9X6S-PM8
	2.4 GHz**	2 miles	IP67, NEMA 6	Yes	DX80N2X6S-PM8

### PM8L Node, 10-30 V DC

	Frequency	Range <sup>†</sup>	Environmental Rating	LCD Screen	Models
<b>Inputs:</b> Six sourcing discrete <b>Outputs:</b> Six sourcing discrete	900 MHz*	6 miles	IP67, NEMA 6	No	DX80N9X6S-PM8L
	2.4 GHz**	2 miles	IP67, NEMA 6	No	DX80N2X6S-PM8L

### PM8 Kits (Includes one PM8 Gateway, and one PM8 Node), 10-30 V DC

	Frequency	Range <sup>†</sup>	Environmental Rating	Models
<b>Inputs:</b> Six sourcing discrete <b>Outputs:</b> Six sourcing discrete	900 MHz	6 miles	IP67, NEMA 6	DX80K9M6-PM8
	2.4 GHz	2 miles	IP67, NEMA 6	DX80K2M6-PM8

For accessories see page 530.

\* Must be used with 900 MHz Gateway

\*\* Must be used with 2.4 GHz Gateway

† Line of sight with included 2 dB antenna. High-gain antennas available for increased range. See accessories page 530.



PM Series Specifications

<b>Power</b>	10 to 30 V dc (For European applications: 12 to 24 V dc, +/- 10%)
<b>Radio Range</b>	<p><b>900 MHz:</b> Up to 9.6 kilometers (6 miles)*</p> <p><b>2.4 GHz:</b> Up to 3.2 kilometers (2 miles)*</p> <p>* Line of sight with included 2 dB antenna. High-gain antennas available for increased range. See page 530.</p>
<b>Transmit Power</b>	<p><b>900 MHz (1 Watt):</b> 30 dBm (1 W) conducted (up to 36 dBm EIRP)</p> <p><b>2.4 GHz:</b> 18 dBm (65 mW) conducted, less than or equal to 20 dBm (100 mW) EIRP</p>
<b>Network Size</b>	1 Gateway and 1 Node, pre-mapped from factory Other advanced options available. See data sheet for more information.
<b>I/O</b>	Discrete and Analog depending on model
<b>Power Consumption</b>	<b>900 MHz Consumption:</b> Maximum current draw is <100 mA and typical current draw is <50 mA at 24 V dc (2.4 GHz consumption is less)
<b>Environmental Rating</b>	IEC IP67; NEMA 6

See [Bannerengineering.com](http://Bannerengineering.com) for more detailed specifications.

# PB2 Board Module

## Discrete & Analog Wire Replacement



- Easy-to-Use
- Simple yet highly expandable
- Supports Point to Point and Star network topologies
- One Gateway can support up to 2 nodes

### PB2 Gateway, 10-30 V DC

I/O	Frequency	Range*	Environmental Rating	Models
<b>Inputs:</b> Two sourcing discrete & Two 0-20 mA analog	900 MHz	6 miles	IP67, NEMA 6	DX80G9M6S-PB2
<b>Outputs:</b> Two sourcing discrete & Two 0-20 mA analog	2.4 GHz	2 miles		DX80G2M6S-PB2

### PB2 Node, 10-30 V DC

I/O	Frequency	Range*	Environmental Rating	Models
<b>Inputs:</b> Two sourcing discrete & Two 0-20 mA analog	900 MHz	6 miles	IP67, NEMA 6	DX80N9X6S-PB2
<b>Outputs:</b> Two sourcing discrete & Two 0-20 mA analog	2.4 GHz	2 miles		DX80N2X6S-PB2

For accessories see page 530.

\* Line of sight with included 2 dB antenna. High-gain antennas available for increased range. See accessories page 530.

### PB2 Specifications

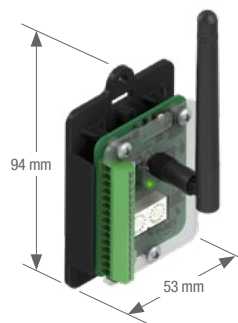

Range	<b>900 MHz:</b> Up to 9.6 kilometers (6 miles)* <b>2.4 GHz:</b> Up to 3.2 kilometers (2 miles)* * Line of sight with included 2 dB antenna. High-gain antennas available for increased range. See page 530.
Transmit Power	<b>900 MHz (1 Watt):</b> 30 dBm (1 W) conducted (up to 36 dBm EIRP) <b>2.4 GHz:</b> 18 dBm (65 mW) conducted, less than or equal to 20 dBm (100 mW) EI
Network Size	1 Gateway and 1 Node, pre-mapped from factory Other advanced options available. Contact factory for more information.
I/O	Discrete, Analog
Power	10 to 30 V dc (For European applications: 12 to 24 V dc, +/- 10%)
Power Consumption	<b>900 MHz, 1 Watt:</b> Approx. 30 mA <b>900 MHz, 250 mW:</b> Approx. 25 mA <b>2.4 GHz, 65 mW:</b> Approx. 20 mA

See [Bannerengineering.com](http://Bannerengineering.com) for more detailed specifications.

# Serial Data Radio

## Serial Wire Replacement



- Easy-to-Use
- DIP switches select operational modes
- FHSS radios operate and synchronize automatically
- Support RS-232 or RS-485

### SR 900 MHz, 10-30 V DC

Environmental Rating	Protocol	Range†	Models*
IP67, NEMA 6	RS-232 or RS-45	6 miles	DX80SR9M-H

### SR 2.4 GHz, 10-30 V DC

Environmental Rating	Protocol	Range†	Models**
IP67, NEMA 6	RS-232 or RS-45	2 miles	DX80SR2M-H

For accessories see page 530.

\* Must be used with 900 MHz Serial Data Radio

\*\* Must be used with 2.4 GHz Serial Data Radio

† Line of sight with included 2 dB antenna. High-gain antennas available for increased range. See accessories page 530.

### Serial Radio Specifications

Range	<b>900 MHz:</b> Up to 9.6 kilometers (6 miles)* <b>2.4 GHz:</b> Up to 3.2 kilometers (2 miles)* * Line of sight with included 2 dB antenna. High-gain antennas available for increased range. See page 530.
Transmit Power	<b>900 MHz (1 Watt):</b> 30 dBm (1 W) conducted (up to 36 dBm EIRP) <b>2.4 GHz:</b> 18 dBm (65 mW) conducted, less than or equal to 20 dBm (100 mW) EI
Network Size	One Master Radio and multiple Slave radios per network. Other advanced options available. Contact factory for more information.
Power	10 to 30 V dc (For European applications: 12 to 24 V dc, +/- 10%)
Environmental Rating	IEC IP67; NEMA 6

See [Bannerengineering.com](http://Bannerengineering.com) for more detailed specifications.



# Ethernet Data Radio

## Ethernet & Serial Wire Replacement



- Sure Cross® MultiHop Ethernet Data Radios are wireless industrial communication devices used to extend the range of serial communication networks.
- No IP address configuration is required
- Built-in site survey mode enables rapid assessment of a location's RF transmission properties

### ER 900 MHz, 10-30 V DC

Environmental Rating	Protocol	Range	Models*
IP20, NEMA 1	Ethernet	6 miles†	DX80ER9M-H

\* Must be used with 900 MHz models

### ER 2.4 GHz, 10-30 V DC

Environmental Rating	Protocol	Range	Models**
IP20, NEMA 1	Ethernet	2 miles†	DX80ER2M-H

For accessories see page 530.

\* Must be used with 900 MHz Ethernet Data Radio

\*\* Must be used with 2.4 GHz Ethernet Data Radio

† Line of sight with included 2 dB antenna. High-gain antennas available for increased range. See accessories page 530.

### Ethernet Radio Specifications

Range	<b>900 MHz:</b> Up to 9.6 kilometers (6 miles)† <b>2.4 GHz:</b> Up to 3.2 kilometers (2 miles)† † Line of sight with included 2 dB antenna.
Transmit Power	<b>900 MHz (1 Watt):</b> 30 dBm (1 W) conducted (up to 36 dBm EIRP) <b>2.4 GHz:</b> 18 dBm (65 mW) conducted, less than or equal to 20 dBm (100 mW) EI
Network Size	One Master Radio and multiple Slave radios per network. Other advanced options available. Contact factory for more information.
Power	10 to 30 V dc (For European applications: 12 to 24 V dc, +/- 10%)
Environmental Rating	IP20, NEMA 1

See [Bannerengineering.com](http://Bannerengineering.com) for more detailed specifications.





# DXER9 Ethernet Data Radio

## Ethernet Wire Replacement



- The Sure Cross® Ethernet radio is an industrial grade, long range, 900 MHz radio used to create point to multipoint configurations of wireless Ethernet networks.
- DIP switches select operational modes
- FHSS radios operate and synchronize automatically

### DXER9 900 MHz, 10-30 V DC

Environmental Rating	Transmit Power	Range	Models*
IP55	125 mW	40 miles LOS with 15 dBi antenna	DXER9

For accessories see page 530.

\* Available in 900 MHz frequency only. Must be used with 900 MHz Gateway

\*\* Must be used with 2.4 GHz Gateway

† Line of sight with included 15 dBi antenna. High-gain antennas available for increased range. See accessories page 530.

### DXER9 Specifications

Range	900 MHz: Up to 40 miles† † Line of sight with included 15 dBi antenna.
Output Power	+21 dBm (4 Watts EIRP used with 15 dBi antenna)
Power Consumption	<b>Transmit:</b> 1.7 Watts <b>Receiver:</b> 0.8 Watts
Power	10 to 30 V dc (For European applications: 12 to 24 V dc, +/- 10%)
Environmental Rating	IP65

See [Bannerengineering.com](http://Bannerengineering.com) for more detailed specifications.



# Wireless Q45 Series

## Digital Wire Replacement



- Solve challenging applications or add sensing to existing industrial systems
- First self-contained wireless standard sensor solution designed for your most challenging control and monitoring applications
- Simple yet highly expandable
- IP67 rated housing for use in demanding environments

### Wireless Q45 Series

Description	I/O	Range	Environmental Rating	Models
900 MHz Remote Device	<b>Inputs:</b> two discrete or one NAMUR proximity sensor	up to 3.2 km	IP67, NEMA 6	DX80N9Q45RD
2.4 GHz Remote Device	<b>Inputs:</b> two discrete or one Namur proximity sensor	up to 1,000 m	IP67, NEMA 6	DX80N2Q45RD
900 MHz Push Button	<b>Inputs:</b> one button <b>Outputs:</b> two color light	up to 3.2 km	IP67, NEMA 6	DX80N9Q45BL-RYGB
2.4 GHz Push Button	<b>Inputs:</b> one button <b>Outputs:</b> two color light	up to 1,000 m	IP67, NEMA 6	DX80N2Q45BL-YG DX80N2Q45BL-RY DX80N2Q45BL-RG DX80N2Q45BL-RG-L
Temperature & Humidity	<b>Inputs:</b> temp & humidity <b>Outputs:</b> 4 – 20 mA	up to 3.2 km	IP67, NEMA 6	M12FTH4Q + DX80N9Q45TH
Temperature & Humidity	<b>Inputs:</b> temp & humidity <b>Outputs:</b> 4 – 20 mA	up to 1,000 m	IP67, NEMA 6	M12FTH4Q + DX80N2Q45TH
Temperature	<b>Inputs:</b> temperature <b>Outputs:</b> 4 – 20 mA	up to 3.2 km	IP67, NEMA 6	M12FT4Q + DX80N9Q45TH
Temperature	<b>Inputs:</b> temperature <b>Outputs:</b> 4 – 20 mA	up to 1,000 m	IP67, NEMA 6	M12FT4Q + DX80N2Q45TH

For accessories see page 530

† With included 2 dB antenna and a Q45 Wireless Node. High-gain antennas available for increased range. See accessories page 530



Q45 Remote Device



Q45 Push Button



Q45 Temp & Humidity

### Q45 Wireless Specifications

Range	<p><b>900 MHz:</b> Up to 3.2 km*</p> <p><b>2.4 GHz:</b> Up to 1,000 m*</p> <p>* With line of sight</p>
Transmit Power	<p><b>900 Mhz:</b> 25 dBm conducted</p> <p><b>2.4 GHz:</b> 65 mW EIRP</p>
Network Size	<p>1 Gateway and 1 Node, pre-mapped from factory</p> <p>Other advanced options available. Contact factory for more information.</p>
Power	<p>Two lithium AA batteries</p>
Environmental Rating	<p>IEC IP67; NEMA 6</p>

See [Bannerengineering.com](http://Bannerengineering.com) for more detailed specifications.

# Wireless Q120 Node

## Six-Button and Light Pendant



- DIP switch configurable
- Six push-button inputs with momentary or toggle operation
- Six sets of red and green LED indicator lights with solid or flashing operation
- Reliable, field-proven Sure Cross wireless architecture operates in the globally accepted 2.4 GHz frequency band or the long-range 900 Mhz frequency band, depending upon model

### Q120 Node

Frequency	Range	Models*
900 MHz	Up to 3.2 km	DX80N9Q120BL-RG
2.4 GHz	Up to 1000 m	DX80N2Q120BL-RG

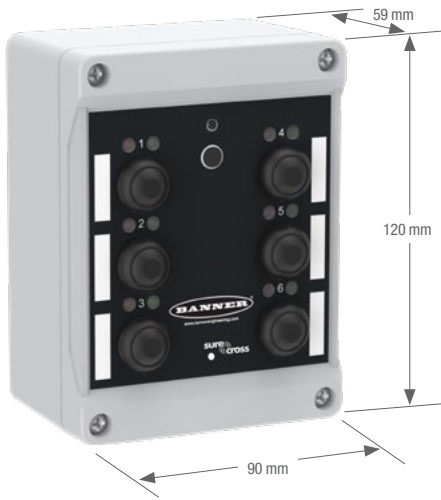

Q120 Specifications

Power Supply	Integrated Battery; D-Cell lithium
Typical Battery Life	Up to 3 years, typical
Range	900 MHz: Up to 3.2 km 2.4 GHz: Up to 1,000 m
Indicators	Red and Green LEDs
Operating Conditions	-40 to +70 °C (-40 to +158 °F) 90% at +50 °C maximum relative humidity (non-condensing)
Spread Spectrum Technology	FHSS (Frequency Hopping Spread Spectrum)

See [Bannerengineering.com](http://Bannerengineering.com) for more detailed specifications.

# QM42VT

## Vibration and Temperature Sensor



- Avoid machine failures and delays by detecting problems early
- Paired with a Banner wireless node, it can monitor remote machines and provide local indication, wirelessly send the signal to a central location, and send the vibration and temperature data to the Gateway for collection and trending
- Reduce downtime and plan maintenance more efficiently
- Monitor a variety of machines to suit your needs

### Sensor with Serial Interface

Description	Model
Vibration and temperature sensor via a 1-wire serial interface	QM42VT1
Vibration and temperature sensor that functions as a modbus slave device via RS-485	QM42VT2





5-Pin

**Euro-Style**  
Double-ended  
male/female

- DEE2R-51D**  
0.3 m (1')
- DEE2R-53D**  
0.9 m (3')
- DEE2R-58D**  
2.4 m (8')

**Adapter Cables**

USB to RS-485

**BWA-HW-006**

USB-to-RS-232 1-Wire

**BWA-USB1WIRE-001**

Additional cordset information is available.  
See page 758



**BWA-BK-002**



**BWA-BK-001**

QM42VT Vibration and Temperature Sensor Specifications

Supply Voltage	3.6 to 5.5 V dc	
Current	<b>QM42VT1 Active comms:</b> 11.9 mA at 5.5 V dc	<b>QM42VT2 Active comms:</b> 8.8 mA at 24 V dc
Communication Hardware	<b>QM42VT1 Interface:</b> 1-wire serial interface <b>Baud rates:</b> 9.6k, 19.2k (default), or 38.4k <b>Data format:</b> 8 data bits, no parity (default), 1 stop bit (even or odd parity available)	<b>QM42VT2 Interface:</b> RS-485 serial <b>Baud rates:</b> 9.6k, 19.2k (default), or 38.4k <b>Data format:</b> 8 data bits, no parity (default), 1 stop bit (even or odd parity available)
Communication Protocol	<b>QM42VT1:</b> Sure Cross® DX80 Sensor Node 1-wire serial Interface <b>QM42VT2:</b> Modbus RTU	
Communications Line	<b>Level Receive ON:</b> Greater than 2 V <b>Level Receive OFF:</b> Less than 0.7 V	<b>Level Transmit ON:</b> 2.7 to 3 V <b>Level Transmit OFF:</b> 0 V (pulldown resistor of 10 kOhm)
Vibration Sensor	<b>QM42VT1 mounted base resonance:</b> 5.5 kHz nominal <b>QM42VT1 frequency range:</b> 10–1000 Hz <b>Measuring Range:</b> 0–46 mm/sec or 0–1.8 in/sec <b>Accuracy:</b> ±10% and 25 °C	<b>QM42VT2 mounted base resonance:</b> 4.5 kHz nominal <b>QM42VT2 frequency range:</b> 10–4 kHz <b>Measuring Range:</b> 0–46 mm/sec or 0–1.8 in/sec <b>Accuracy:</b> ±10% and 25 °C
Connector	3 m cable with 5-pin M12 fitting	
Indicators	<b>Green flashing:</b> Power ON	<b>Amber flicker:</b> Serial Tx
Temperature Sensor	<b>Measuring range:</b> –40 to +105 °C (–40 to +221 °F) <b>Resolution:</b> 0.1 °C <b>Accuracy:</b> ± 3 °C	
Environmental Rating	NEMA 6P, IEC IP67	
Operating Conditions	<b>QM42VT1:</b> –40 to 85 °C (–40 to +185 °F)	<b>QM42VT2:</b> –40 to 105 °C (–40 to +221 °F)
Shock and Vibration	400G	
Mounting Options	Can be mounted using a variety of methods, including 1/4 inch 28 hex screw, epoxy, thermal tape, or magnetic mount	

# K50U Series

## Wireless Ultrasonic Sensor



- Provides a distance measurement from the target to the sensor
- Three meter sensing range with a 300 mm dead zone
- Built-in temperature compensation
- Rugged design for demanding sensing environments; rated IEC IP67, NEMA 6P
- Two sensor models available; one with a 1-wire serial interface and one that functions as a Modbus slave via RS-485

### K50U Ultrasonic Sensor

Description	Models
Ultrasonic sensor with 1-wire serial interface	K50UX1RA
Ultrasonic sensor that functions as a modbus slave device via RS-485	K50UX2RA





**Euro-Style**  
Double-ended  
male/female

**5-Pin**  
**DEE2R-51D**  
0.3 m (1')  
**DEE2R-53D**  
0.9 m (3')  
**DEE2R-58D**  
2.4 m (8')

Additional cordset information is available.  
See page 758



**BWA-BK-006**  
shown with: K50U and Q45U



**BWA-BK-004**  
use with: K50U and DX80 or Q45U



**K50U Ultrasonic Sensor Specifications**

<b>Supply Voltage</b>	3.6 to 5.5 V dc or 10 to 30V dc	
<b>Current</b>	<b>K50UX1A active comms:</b> 3.3 mA	<b>K50UX2A active comms:</b> 11.3 mA
<b>Communication Hardware</b>	<b>K50UX1A Interface:</b> 1-wire serial interface <b>Baud rates:</b> 9.6k, 19.2k (default), or 38.4k <b>Data format:</b> 8 data bits, no parity (default), 1 stop bit (even or odd parity available)	<b>K50UX2A Interface:</b> RS-485 serial <b>Baud rates:</b> 9.6k, 19.2k (default), or 38.4k <b>Data format:</b> 8 data bits, no parity (default), 1 stop bit (even or odd parity available)
<b>Communication Protocol</b>	<b>K50UX1A:</b> Sure Cross® DX80 Sensor Node 1-wire serial Interface	<b>K50UX2A:</b> Modbus RTU
<b>Communications Line</b>	<b>Level Receive ON:</b> Greater than 2 V <b>Level Receive OFF:</b> Less than 0.7 V	<b>Level Transmit ON:</b> 2.7 to 3 V <b>Level Transmit OFF:</b> 0 V (pulldown resistor of 10 kOhm)
<b>Connector</b>	Integral 5-pin M12/Euro-style male quick disconnect (QD)	
<b>Indicators</b>	Two LEDs	
<b>Construction</b>	<b>Housing:</b> PBT polyester <b>Transducer:</b> epoxy/ceramic composite	
<b>Environmental Rating</b>	Leakproof design, rated IEC IP67 (NEMA 6)	
<b>Operating Conditions</b>	<b>Temperature:</b> -40 to 70 °C (-40 to 158 °F)	<b>Relative humidity:</b> 95% at +50 °C maximum (non-condensing)
<b>Shock and Vibration</b>	All models meet Mil Std. 202F requirements. Method 201A (vibration: 10 Hz to 60 Hz max., double amplitude 0.06 inch, maximum acceleration 10G). Also m meets IEC 947-5-2 requirements: 30G 11 ms duration, half sine wave	

# Temp and Humidity Solutions

## 1-Wire Serial or Modbus RTU, RS-485 interface



- Reliable environmental measurements without the need for costly wiring runs to the monitoring points
- Achieves humidity accuracy of  $\pm 2\%$  relative humidity and temperature accuracy of  $\pm 0.3$  °C.
- Temperature and relative humidity sensing elements housed in a robust stainless steel probe
- Traceable to NIST standards
- Available in 900 MHz and 2.4 GHz

### Sensors with a Serial Interface

Description	Models
Temperature sensor with 1-wire serial interface	M12FT4Q
Temperature and humidity sensor with 1-wire serial interface	M12FTH4Q

### Sensors with a Modbus RTU, RS-485 interface

Description	Models
Temperature sensor with Modbus RTU, RS-485 interface	M12FT3Q
Temperature and humidity sensor with Modbus RTU, RS-485 interface	M12FTH3Q

For accessories see page 530.

Replacement Filters



FTH-FIL-001



FTH-FIL-002

Additional accessory information is available.  
See page 541

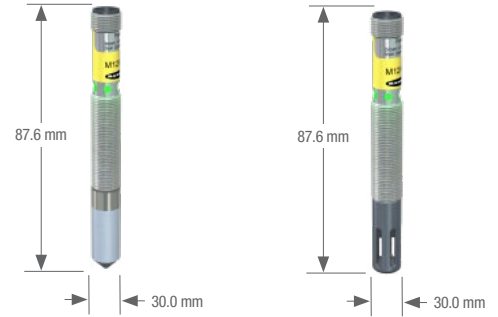

M12 Wireless 1-wire Serial interface Specifications

Supply Voltage	3.6 to 5.5 V dc
Current	<b>Default sensing:</b> 28 $\mu$ Amps <b>Disabled sensing:</b> 15 $\mu$ Amps <b>Active comms:</b> 4.7 mA
Mounting Threads	M12 x 1
Temperature	<b>Measuring range:</b> -40 to +85 °C (-40 to +185 °F) <b>Resolution:</b> 0.1 °C <b>Accuracy:</b> $\pm$ 0.3 °C at 25 °C
Humidity*	<b>Measuring range:</b> 0 to 100% relative humidity <b>Resolution:</b> 0.1% relative humidity <b>Accuracy:</b> $\pm$ 2% relative humidity at 25 °C
Environmental Rating	IEC IP67, NEMA 6
Operating Temperature**	-40 to +85 °C (-40 to +185 °F)
Shock & Vibration	IEC 68-2-6 and IEC 68-2-27 <b>Shock:</b> 30g, 11 millisecond half sine wave, 18 shocks <b>Vibration:</b> 0.5 mm p-p, 10 to 60 Hz

M12 Wireless Modbus Specifications

Supply Voltage	12 to 24 V dc OR 3.6 to 5.5 V dc low power option
Current	<b>Default sensing:</b> 45 $\mu$ Amps <b>Disabled sensing:</b> 32 $\mu$ Amps <b>Active comms:</b> 4 mA
Mounting Threads	M12 x 1
Temperature	<b>Measuring range:</b> -40 to +85 °C (-40 to +185 °F) <b>Resolution:</b> 0.1 °C <b>Accuracy:</b> $\pm$ 0.3 °C at 25 °C
Humidity*	<b>Measuring range:</b> 0 to 100% relative humidity <b>Resolution:</b> 0.1% relative humidity <b>Accuracy:</b> $\pm$ 2% relative humidity at 25 °C
Environmental Rating	IEC IP67; NEMA 6
Operating Temperature**	-40 °C to +85 °C (-40 °F to +185 °F)
Shock & Vibration	IEC 68-2-6 and IEC 68-2-27 <b>Shock:</b> 30g, 11 millisecond half sine wave, 18 shocks <b>Vibration:</b> 0.5 mm p-p, 10 to 60 Hz

\* M12FTH3Q and M12FTH4Q only

\*\* Operating the devices at the maximum operating conditions for extended periods can shorten the life of the device.

See [Bannerengineering.com](http://Bannerengineering.com) for more detailed specifications.

# DX80 Performance Series

## Gateways and Nodes



- Create point to multi point networks that distribute I/O over large areas.
- Input and output types include discrete (dry contact, PNP/NPN), analog (0 to 10 V dc, 0 to 20 mA), temperature (thermocouple and RTD), and pulse counter.
- Enhanced gateways and nodes offer increased range in the 900 MHz frequency band
- High density I/O capacity provides up to 12 discrete inputs or outputs or a mix of discrete and analog I/O
- Universal analog inputs allow current or voltage to be selected in the field

### DX80 Performance Gateways, 10-30 V DC

I/O	Frequency	Housing	Models
N/A	900 MHz	Low Profile	DX80G9M2S-P
	2.4 GHz		DX80G2M2S-P
<b>Inputs:</b> Four selectable discrete, two 0–20 mA or 0–10 V analog <b>Outputs:</b> Four sourcing discrete, two 0–20mA analog	900 MHz	IP67	DX80G9M6S-P2
	2.4 GHz		DX80G2M6S-P2
<b>Inputs/Outputs:</b> Up to 12 NPN inputs or up to 12 NMOS outputs, or a mix of inputs and outputs not exceeding 12 I/O points	900 MHz	IP67	DX80G9M2S-P7
	2.4 GHz		DX80G2M2S-P7
<b>Inputs/Outputs:</b> Up to 12 PNP inputs or up to 12 PNP outputs, or a mix of inputs and outputs not exceeding 12 I/O points	900 MHz	IP67	DX80G9M6S-P8
	2.4 GHz		DX80G2M6S-P8

### DX80 Performance Gateways, board only models, 10-30 V DC

I/O	Frequency	Housing	Models
<b>Inputs:</b> Two sourcing discrete, two 0-20 mA analog <b>Outputs:</b> Two sourcing discrete, two 0-20 mA analog	900 MHz	Board Module	DX80G9M6S-PB2
	2.4 GHz		DX80G2M6S-PB2

### DX80 Performance nodes, board only models, 10-30 V DC

I/O	Frequency	Housing	Models
<b>Inputs:</b> Two NPN discrete, two 0-20 mA analog <b>Outputs:</b> Two NMOS discrete <b>Switch Power:</b> Two	900 MHz	Board Module	DX80N9X2S-PB1
	2.4 GHz		DX80N2X2S-PB1
<b>Inputs:</b> Two PNP discrete, two 0-20 mA analog <b>Outputs:</b> Two PNP discrete, two 0-20 mA analog	900 MHz	Board Module	DX80N9X6S-PB2
	2.4 GHz		DX80N2X6S-PB2

DX80 Performance nodes, 10-30 V DC (“E” models have integrated batteries)

I/O	Frequency	Models*
<b>Discrete Mode</b> <b>Inputs:</b> Two selectable discrete and two thermistor <b>Outputs:</b> Two NMOS discrete <b>Switch Power:</b> Two	900 MHz	DX80N9X2S-P1
	2.4 GHz	DX80N2X2S-P1
<b>Analog Mode</b> <b>Inputs:</b> Two selectable discrete, two analog (0-20 mA or 0-10 V), and two thermistor <b>Outputs:</b> Two NMOS discrete <b>Switch Power:</b> One	900 MHz	DX80N9X1S-P1E
	2.4 GHz	DX80N2X1S-P1E
<b>Inputs:</b> Four selectable discrete, two 0-20 mA or 0-10 V (universal) analog <b>Outputs:</b> Four PNP discrete, two 0-20mA analog	900 MHz	DX80N9X6S-P2
	2.4 GHz	DX80N2X6S-P2
<b>Inputs:</b> Two selectable discrete, four thermocouple, one thermistor for CJC <b>Outputs:</b> One NMOS discrete	900 MHz	DX80N9X2S-P3
	2.4 GHz	DX80N2X2S-P3
	900 MHz	DX80N9X1S-P3E
	2.4 GHz	DX80N2X1S-P3E
<b>Inputs:</b> Four 3-wire RTDs	900 MHz	DX80N9X2S-P4
	2.4 GHz	DX80N9X1S-P4E
<b>Inputs:</b> Two NPN discrete, four selectable analog (0-20 mA or 0-10 V) <b>Outputs:</b> Two NMOS discrete <b>Switch Power:</b> Two	900 MHz	DX80N9X2S-P5
	2.4 GHz	DX80N2X2S-P5
<b>Inputs:</b> 1-Wire serial interface for one serial sensing device	900 MHz	DX80N9X1S-P6
	2.4 GHz	DX80N2X1S-P6
<b>Inputs/Outputs:</b> Up to 12 NPN inputs or up to 12 NMOS outputs, or a mix of inputs and outputs not exceeding 12 I/O points	900 MHz	DX80N9X2S-P7
	2.4 GHz	DX80N2X2S-P7
<b>Inputs/Outputs:</b> Up to 12 PNP inputs or up to 12 PNP outputs, or a mix of inputs and outputs not exceeding 12 I/O points	900 MHz	DX80N9X6S-P8
	2.4 GHz	DX80N2X6S-P8
<b>Discrete Mode</b> <b>Inputs:</b> One configurable discrete, one thermistor, one asynchronous counter <b>Switch Power Outputs:</b> One <b>Analog Mode:</b> <b>Inputs:</b> One configurable discrete, one configurable analog, one thermistor, one asynchronous counter <b>Switch Power Outputs:</b> One	900 MHz	DX80N9X1S-P14
	2.4 GHz	DX80N2X1S-P14
<b>Inputs:</b> Two selectable discrete <b>Outputs for DC Latch:</b> DC Latch	900 MHz	DX80N9X2S-DCLATCHE
	2.4 GHz	DX80N2X2S-DCLATCHE

DX80 Performance Series Specifications

Range	<b>900 MHz, 1 Watt:</b> Up to 9.6 km (6 miles) <b>2.4 GHz, 65 mW:</b> Up to 3.2 km (2 miles)
Minimum Separation Distance	<b>900 MHz, 1 Watt:</b> 4.57 m (15 ft) <b>2.4 GHz 65 mW:</b> 0.3 m (1 ft)
Transmission Power	<b>900 MHz, 1 Watt:</b> 30 dBm (1 W) conducted (up to 36 dBm EIRP) <b>2.4 GHz, 65 mW:</b> 18 dBm (65 mW) conducted, less than or equal to 20 dBm (100 mW) EIRP
Communication Hardware (RS-485)	<b>Interface:</b> 2-wire half-duplex RS-485 <b>Baud rates:</b> 9.6k, 19.2k (default), or 38.4k <b>Data format:</b> 8 data bits, no parity, 1 stop bit
Supply Voltage	10 to 30 V dc
Interface	<b>Indicators:</b> Two bi-color LEDs <b>Buttons:</b> Two <b>Display:</b> Six character LCD
Operating Conditions	-40 to +85 °C (-40 to +185 °F) (Electronics); -20 to +80 °C (-4 to +176 °F) (LCD) 95% maximum relative humidity (non-condensing) <b>Radiated Immunity:</b> 10 V/m (EN 61000-4-3)
Environmental Rating	<b>DX80 Models:</b> IEC IP67; NEMA 6 <b>“C” Models:</b> IP20; NEMA 1 <b>“E” Models:</b> IP65; NEMA 4X

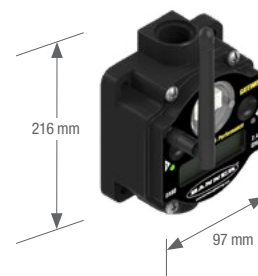

See [Bannerengineering.com](http://Bannerengineering.com) for more detailed specifications.

# MultiHop Modbus

## Modbus Radios and Boards with I/O



- MultiHop Modbus data radios extend the range of Modbus or other Serial communication networks
- Models are available with built in discrete and analog I/O, which can be accessed using the Modbus protocol
- Self-healing, auto routing RF network with multiple hops extends the network's range
- Flexible: dip switch selectable to be a master, repeater or slave
- User selectable communication between RS-485 and RS-232

MultiHop Modbus Radios with I/O, 10-30 V DC  
("E" and "H6" models have integrated batteries)

I/O	Frequency	Housing	Models
<b>Inputs:</b> Four discrete, two 0-20 mA analog, one thermistor, one counter <b>Outputs:</b> Two NMOS discrete <b>Switch Power:</b> Two <b>Serial interface:</b> RS-485	900 MHz	IP67	DX80DR9M-H1
		IP54	DX80DR9M-H1E
	2.4 GHz	IP67	DX80DR2M-H1
		IP54	DX80DR2M-H1E
<b>Inputs:</b> Four discrete, two 0-20 mA analog <b>Outputs:</b> Four sourcing discrete, two 0-20 mA analog <b>Serial interface:</b> RS-485	900 MHz	IP67	DX80DR9M-H2
	2.4 GHz	IP67	DX80DR2M-H2
<b>Inputs:</b> Two discrete, four thermocouple, one thermistor (internal) <b>Outputs:</b> Two NMOS discrete <b>Serial interface:</b> RS-232	900 MHz	IP67	DX80DR9M-H3
		IP54	DX80DR9M-H3E
	2.4 GHz	IP67	DX80DR2M-H3
		IP54	DX80DR2M-H3E
<b>Inputs:</b> Four 3-wire Pt100 RTD <b>Serial interface:</b> RS-232	900 MHz	IP67	DX80DR9M-H4
	2.4 GHz	IP54	DX80DR9M-H4E
	900 MHz	IP67	DX80DR2M-H4
	2.4 GHz	IP54	DX80DR2M-H4E
<b>Inputs:</b> Four sinking discrete, four 0-20 mA analog <b>Outputs:</b> Two NMOS discrete <b>Switch Power:</b> Two <b>Serial Interface:</b> RS-485	900 MHz	IP67	DX80DR9M-H5
	2.4 GHz		DX80DR2M-H5
<b>Inputs:</b> 1-Wire serial interface for one 1-wire serial sensing device	900 MHz	IP67	DX80DR9M-H6
	2.4 GHz		DX80DR2M-H6
<b>Inputs:</b> Two discrete, two 0-20 mA analog,   one thermistor, one SDI-12 or counter <b>Outputs:</b> Two NMOS discrete <b>Switch Power:</b> Two <b>Serial interface:</b> RS-485	900 MHz	IP67	DX80DR9M-H12
	2.4 GHz		DX80DR2M-H12
<b>Inputs:</b> Two sinking discrete <b>Outputs for DC Latch:</b> DC Latch	900 MHz	IP54	DX80DR9M-DCLATCHE
	2.4 GHz		DX80DR2M-DCLATCHE



Board level MultiHop Modbus Data Radios with I/O

I/O	Frequency	Models
<b>Inputs:</b> Two NPN discrete, two 0 to 20 mA analog <b>Outputs:</b> Two NMOS discrete <b>Switch Power Outputs:</b> Two	900 MHz	<b>DX80DR9M-HB1</b>
	2.4 GHz	<b>DX80DR2M-HB1</b>
<b>Inputs:</b> Two PNP discrete, two 0 to 20 mA analog <b>Outputs:</b> Two PNP discrete, two 0 to 20 mA analog	900 MHz	<b>DX80DR9M-HB2</b>
	2.4 GHz	<b>DX80DR2M-HB2</b>

MultiHop Modbus Specifications

<b>Radio Range</b>	<b>900 MHz, 1 Watt:</b> Up to 9.6 km (6 miles)	<b>2.4 GHz, 65 mW:</b> Up to 3.2 km (2 miles)
<b>Minimum Separation Distance</b>	<b>900 MHz, 1 Watt:</b> 4.57 m (15 ft)	<b>2.4 GHz, 65 mW:</b> 0.3 m (1 ft)
<b>Radio Transmit Power</b>	<b>900 MHz, 1 Watt:</b> 30 dBm (1 W) conducted (up to 36 dBm EIRP)	<b>2.4 GHz, 65 mW:</b> 18 dBm (65 mW) conducted, less than or equal to 20 dBm (100 mW) EIRP
<b>Power</b>	<b>FlexPower models:</b> 10 to 30 V dc (Outside the USA: 12 to 24 V dc, ±10%) on the brown wire, or 3.6 to 5.5 V dc low power option on the gray wire 6 <b>Integrated battery models:</b> 3.6 V dc low power option from an internal battery or 10 to 30 V dc <b>Master radio consumption (900 MHz):</b> Maximum current draw is < 100 mA and typical current draw is < 30 mA at 24 V dc (2.4 GHz consumption is less) <b>Repeater/slave radio consumption (900 MHz):</b> Maximum current draw is < 40 mA and typical current draw is < 20 mA at 24 V dc (2.4 GHz consumption is less)	
<b>Compliance</b>	<b>900 MHz Compliance (1 Watt)</b> FCC ID UE3RM1809: This device complies with FCC Part 15, Subpart C, 15.247 IC: 7044A-RM1809	<b>2.4 GHz Compliance</b> FCC ID UE300DX80-2400 - This device complies with FCC Part 15, Subpart C, 15.247 ETSI/EN: In accordance with EN 300 328: V1.8.1 (2012-04) IC: 7044A-DX8024
<b>Spread Spectrum Technology</b>	FHSS (Frequency Hopping Spread Spectrum)	
<b>Antenna Connection</b>	Ext. Reverse Polarity SMA, 50 Ohms      Max Tightening Torque: 0.45 N-m (4 lbf-in)	
<b>Interface</b>	<b>Indicators:</b> Two bi-color LEDs <b>Buttons:</b> Two <b>Display:</b> Six character LCD	
<b>Communication Hardware (MultiHop RS-485)</b>	<b>Interface:</b> 2-wire half-duplex RS-485 <b>Baud rates:</b> 9.6k, 19.2k (default), or 38.4k via DIP switches; 1200 and 2400 via the MultiHop Configuration Tool <b>Data format:</b> 8 data bits, no parity, 1 stop bit	
<b>Packet Size (MultiHop)</b>	<b>900 MHz:</b> 175 bytes (85 Modbus registers)	<b>2.4 GHz:</b> 75 bytes (37 Modbus registers)
<b>Intercharacter Timing (MultiHop)</b>	3.5 milliseconds	
<b>Housing</b>	Polycarbonate housing and rotary dial cover; polyester labels; EDPM rubber cover gasket; nitrile rubber, non-sulphur cured button covers <b>Weight:</b> 0.26 kg (0.57 lbs) <b>M-Hx and M-HxC models:</b> Mounting: #10 or M5 (SS M5 hardware included) <b>M-HxE models:</b> Mounting: 1/4-in or M7 (SS M7 hardware included) <b>Max. Tightening Torque:</b> 0.56 N-m (5 lbf-in)	
<b>Wiring Access</b>	<b>M-Hx models:</b> Four PG-7, One 1/2-in NPT, One 5-pin threaded M12/Euro-style male quick-disconnect <b>M-HxC models:</b> External terminals <b>M-HxE models:</b> Two 1/2-in NPT ports	
<b>Environmental Rating</b>	<b>M-Hx:</b> IEC IP67; NEMA 6 <b>“C” Housing Models:</b> IEC IP20; NEMA 1 <b>“E” Housing Models:</b> IEC IP65; NEMA 4X	
<b>Operating Conditions</b>	<b>M-Hx and M-HxC models:</b> -40 to +85 °C (-40 to +185 °F) (Electronics); -20 to +80 °C (-4 to +176 °F) (LCD) <b>M-HxE models:</b> -40 to +65 °C (-40 to +149 °F) (Electronics); -20 to +80 °C (-4 to +176 °F) (LCD) 95% maximum relative humidity (non-condensing) <b>Radiated Immunity:</b> 10 V/m (EN 61000-4-3)	
<b>Shock and Vibration</b>	IEC 68-2-6 and IEC 68-2-27 <b>Shock:</b> 30g, 11 millisecond half sine wave, 18 shocks <b>Vibration:</b> 0.5 mm p-p, 10 to 60 Hz	
<b>Certifications</b>		



# Sure Cross® DX99

## Intrinsically Safe Star I/O Network Nodes

- Both 900 MHz 150 mW and 2.4 GHz 63 mW models are available
- Networks formed using DX80 Performance Gateways installed beyond the hazardous area and one or more Nodes operating in the same frequency band
- The DX99 is a state-of-the-art combination of wireless communication, battery technology and intrinsically safe electronics
- All models are certified for operation in Class I, Division 1 and ATEX Zone 0 locations

### DX99 Nodes, FlexPower™—Class I, Div 1 and Zone 0 (Metal Housing)

I/O	Frequency	Boost Power	Models*
<b>Discrete:</b> Two inputs <b>Analog:</b> Two inputs (0-20 mA)	900 MHz	10 V	DX99N9X1S2N0M2X0D1
		18 V	DX99N9X1S2N0M2X0D2
<b>Discrete:</b> Two inputs <b>Analog:</b> Two inputs (0-10 V)	900 MHz	10 V	DX99N9X1S2N0V2X0D1
		18 V	DX99N9X1S2N0V2X0D2
<b>Discrete:</b> Two inputs <b>Analog:</b> Two inputs (0-20 mA)	2.4 GHz	10 V	DX99N2X1S2N0M2X0D1
		18 V	DX99N2X1S2N0M2X0D2
<b>Discrete:</b> Two inputs <b>Analog:</b> Two inputs (0-10 V)	2.4 GHz	10 V	DX99N2X1S2N0V2X0D1
		18 V	DX99N2X1S2N0V2X0D2
<b>Thermocouple:</b> Three inputs, one thermistor input <b>Discrete:</b> Two (NPN) inputs	900 MHz	n/a	DX99N9X1S2N0T4X0D0
	2.4 GHz		DX99N2X1S2N0T4X0D0
<b>RTD:</b> Four inputs	900 MHz	n/a	DX99N9X1S0N0R4X0D0
	2.4 GHz		DX99N2X1S0N0R4X0D0
<b>Bridge:</b> Two inputs <b>Discrete:</b> Two inputs	900 MHz	n/a	DX99N9X1S2N0B2X0D0
	2.4 GHz		DX99N2X1S2N0B2X0D0
<b>Inputs (Modbus Mode):</b> One RS-485 <b>Inputs (Voltage Mode):</b> Two analog, one discrete	900 MHz	13V	DX99N9X1S1S0V2X0D4
	2.4 GHz		DX99N2X1S1S0V2X0D4
<b>Inputs:</b> One analog input with a 29 second warm-up time; one sinking discrete <b>Additional Input Configurations:</b> One 3-wire 100-Ohm Platinum RTD, one sinking discrete, and two analog (0-20 mA)	900 MHz	19V	DX99N9X1S1N0M3X0D5
	2.4 GHz		DX99N2X1S1N0M3X0D5

Metal housing models are only available with external antennas and are powered by a 3.6 V D cell lithium battery integrated into the housing. Mounting and intrinsically safe antenna installation accessories are available for the metal housing models.



Sure Cross® DX99 Specifications

Range	<b>900 MHz:</b> Up to 4.8 kilometers (3 miles) <b>2.4 GHz:</b> Up to 3.2 kilometers (2 miles)	
Transmit Power	<b>900 MHz:</b> 150 mW (21 dBm Conducted) <b>2.4 GHz:</b> 65 mW (18 dBm Conducted)	
Network Size	One Gateway and up to 47 remotely located Nodes (SureCross Performance or SureCross DX80 Gateway required)	
I/O	Discrete, Analog, Temperature, Bridge	
Gateway Communications	Sure Cross Performance or Sure Cross DX80 Gateway required	
Power	3.6 V low power option from an internal battery	
Power Consumption	Application Dependent	
Environmental Rating	IEC IP68	
Certifications	DX99, Intrinsically Safe, Metal Housing  Class I, Division 1, Groups A, B, C, D; Class II, Division 1, Groups E, F, G; Class III, Division 1 Ex ia IIC T4 AEx ia IIC T4  LCIE/ATEX Zone 0 (Group IIC) and Zone 20 (Group II) II 1 GD Ex ia IIC T4 Ex iaD 20 IP68 T82°C	
	Certificate 2008243(LR 41887) 	Certificate LCIE 08 ATEX 6098X 

See [Bannerengineering.com](http://Bannerengineering.com) for more detailed specifications.



# DXM100 Wireless Controller

## Industrial Wireless Controller



- ISM radios available in 900 MHz and 2.4 GHz for local wireless network
- Converts Modbus RTU to Modbus TCP/IP or Ethernet I/P
- Logic controller can be programmed using action rules and text language methods
- Cellular connectivity
- Micro SD card for data logging
- Email and text alerts
- Local I/O options: universal inputs, NMOS outputs, and analog outputs
- Powered by 12 to 30 V dc, 12 V dc solar panel, or battery backup
- RS-232, RS-485, and Ethernet communications ports; and a USB configuration port
- LCD display for I/O information and user programmable LED's

### DXM Controllers

Description	Frequency	Models
DXM100 Controller, with DX80 Gateway, preconfigured as a protocol converter	900 MHz	DXM100-B1R1
DXM100 Controller, with DX80 Gateway, preconfigured as a protocol converter	2.4 GHz	DXM100-B1R3
DXM100 Controller with MultiHop Data Radio	900 MHz	DXM100-B1R2
DXM100 Controller with MultiHop Data Radio	2.4 GHz	DXM100-B1R4
DXM100 Controller with DX80 Gateway and CDMA cellular module, preconfigured as a protocol converter	900 MHz	DXM100-B1C1R1
DXM100 Controller with DX80 Gateway and CDMA cellular module, preconfigured as a protocol converter	2.4 GHz	DXM100-B1C1R2

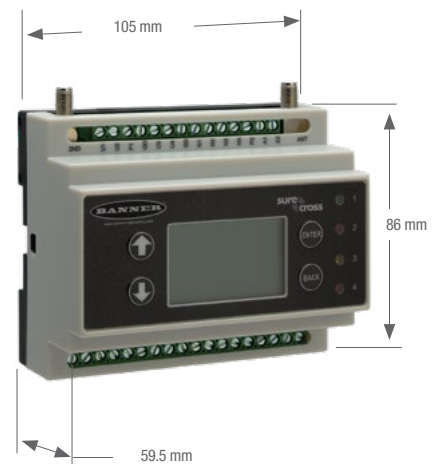

DXM100 Controllers

Supply Voltage	12 to 30 V dc or 12 V dc solar panel and 12 V sealed lead acid battery	
Power Consumption	35 mA average at 12 V	
Solar Power Battery Charging	1 Amp maximum with 20 Watt solar panel	
Radio (ISM Band) Transmit Power	900 MHz at 1 Watt	2.4 GHz at 65 mW
Radio Range	<b>900 MHz, 1 Watt:</b> Up to 9.6 km (6 miles)	<b>2.4 GHz, 65 mW:</b> Up to 3.2 km (2 miles)
Minimum Separation Distance	<b>900 MHz, 1 Watt:</b> 4.57 m (15 ft)	<b>2.4 GHz, 65 mW:</b> 0.3 m (1 ft)
Antenna Connection	Ext. Reverse Polarity SMA, 50 Ohms <b>Max Tightening Torque:</b> 0.45 N-m (4 lbf-in)	
Radio Transmit Power	<b>900 MHz, 1 Watt:</b> 30 dBm (1 Watt) conducted (up to 36 dBm EIRP)	<b>2.4 GHz, 65 mW:</b> 18 dBm (65 mW) conducted, less than or equal to 20 dBm (100 mW EIRP)
Compliance	900 MHz Compliance (1 Watt) FCC ID UE3RM1809: This device complies with FCC Part 15, Subpart C, 15.247 IC: 7044A-RM1809	2.4 GHz Compliance FCC ID UE300DX80-2400 - This device complies with FCC Part 15, Subpart C, 15.247 ETSI/EN: In accordance with EN 300 328: V1.8.1 (2012-04) IC: 7044A-DX8024
Spread Spectrum Technology	FHSS (Frequency Hopping Spread Spectrum)	
Logging	8 GB maximum; removable Micro SD card format	
Protocols	Modbus RTU Master/Slave, Modbus TCP, and Ethernet/IP	
Construction	Polycarbonate; DIN rail mount option	
Communication Hardware (RS-732)	4-wire full duplex; flow control -15 to +15 Volts signaling <b>Baud rates:</b> 9.6k, 19.2k (default), or 38.4k <b>Data format:</b> 8 data bits, no parity, 1 stop bit	
Communication Hardware (RS-485)	2-wire half duplex RS-485 <b>Baud rates:</b> 9.6k, 19.2k (default), or 38.4k <b>Data format:</b> 8 data bits, odd, even or no parity, 1 stop bit	
Universal Inputs	Discrete sinking/sourcing, 0 to 20 mA analog, 0 to 10 V analog, 10k thermistor, counter	
Courtesy Power	One; output at 5 volts , 500 mA maximum	
Switched Power Outputs	5 V/400 mA maximum; 16 V/125 mA maximum	
Environmental Rating	IP20	
Operating Conditions	-40 to +85 °C (-40 to +185 °F) (Electronics); -20 to +80 °C (-4 to +176 °F) (LCD) 95% maximum relative humidity (non-condensing) <b>Radiated Immunity:</b> 10 V/m, 80-2700 MHz (EN 61000-4-3)	
Shock and Vibration	IEC 68-2-6 and IEC 68-2-27 <b>Shock:</b> 30g, 11 millisecond half sine wave, 18 shocks <b>Vibration:</b> .5 mm p-p, 10 to 60 Hz	
Analog Outputs	0 to 20 mA or 0 to 10 V dc output <b>Accuracy:</b> 0.1% of full scale +0.01% per °C <b>Resolution:</b> 12 bit	
NMOS Outputs	Less than 1 A max current at 30 V dc <b>ON-state saturation:</b> less than 0.7 V at 20 mA <b>ON condition:</b> Less than 0.7 V <b>Off condition:</b> Open	
Certifications		

# Accessories

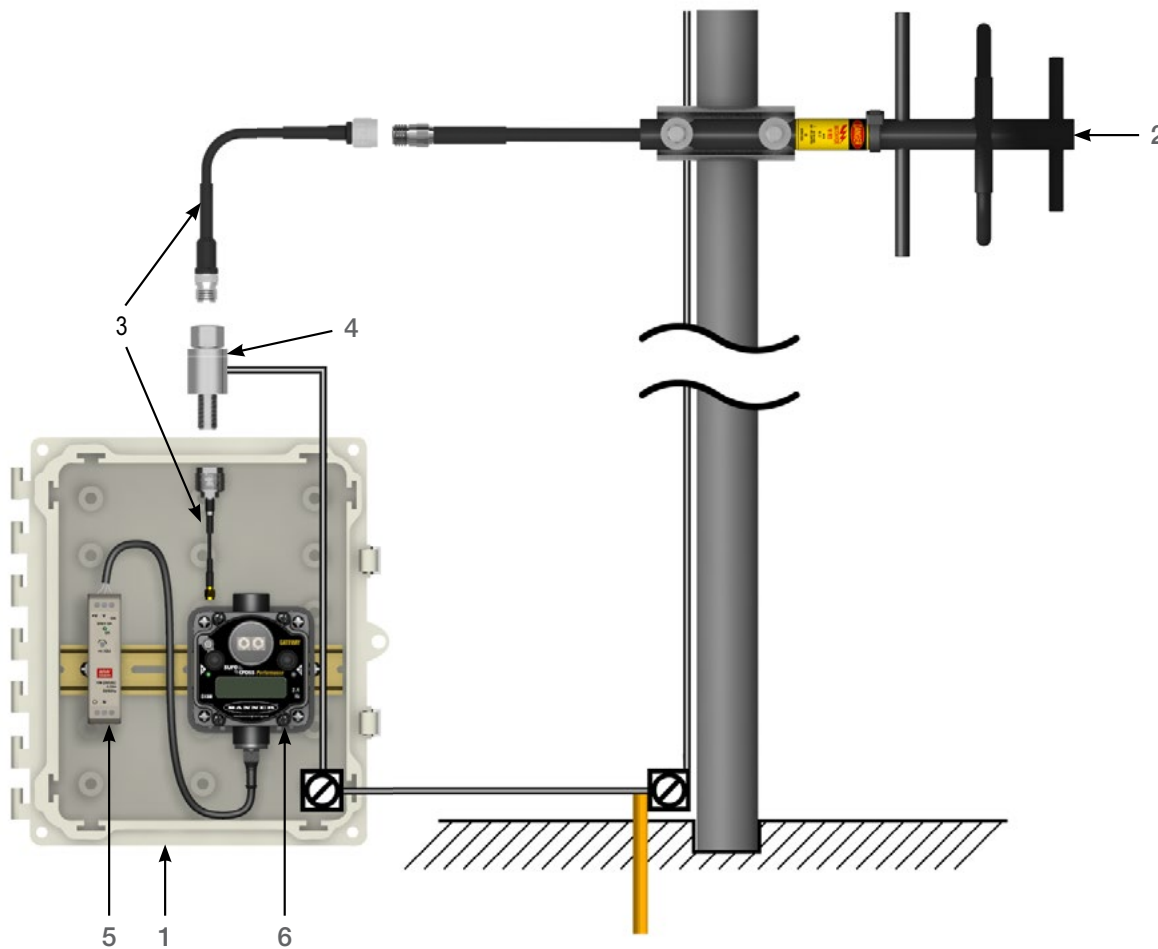

NOTE: The Sure Cross® radio installation shown includes wireless accessories available from Banner. It is for illustration purposes only. Installations may vary.

(1) Enclosures .....	511
(2) Antennas .....	533
(3) Antenna Cables.....	534
(4) Surge Suppressors.....	535
(5) Power Supplies .....	535
(6) Brackets .....	537
Cables .....	538
Cordsets .....	539
Hardware and Replacement Parts.....	541
Replacement Filters .....	541
Cable Glands and Plugs.....	542
Metal Housing Accessories .....	542

(1) Enclosures

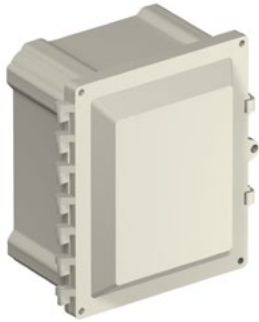

**Polycarbonate Enclosures**

<b>BWA-AH664</b>	Enclosure, Polycarbonate, with Opaque Cover, 6 × 6 × 4 in
<b>BWA-AH864</b>	Enclosure, Polycarbonate, with Opaque Cover, 8 × 6 × 4 in
<b>BWA-AH1084</b>	Enclosure, Polycarbonate, with Opaque Cover, 10 × 8 × 4 in
<b>BWA-AH12106</b>	Enclosure, Polycarbonate, with Opaque Cover, 12 × 10 × 6 in
<b>BWA-AH14126</b>	Enclosure, Polycarbonate, with Opaque Cover, 14 × 12 × 6 in
<b>BWA-AH16148</b>	Enclosure, Polycarbonate, with Opaque Cover, 16 × 14 × 8 in
<b>BWA-AH181610</b>	Enclosure, Polycarbonate, with Opaque Cover, 18 × 16 × 10 in
<b>BWA-AH664C</b>	Enclosure, Polycarbonate, with Clear Cover, 6 × 6 × 4 in
<b>BWA-AH864C</b>	Enclosure, Polycarbonate, with Clear Cover, 8 × 6 × 4 in
<b>BWA-AH1084C</b>	Enclosure, Polycarbonate, with Clear Cover, 10 × 8 × 4 in
<b>BWA-AH12106C</b>	Enclosure, Polycarbonate, with Clear Cover, 12 × 10 × 6 in
<b>BWA-AH14126C</b>	Enclosure, Polycarbonate, with Clear Cover, 14 × 12 × 6 in
<b>BWA-AH16148C</b>	Enclosure, Polycarbonate, with Clear Cover, 16 × 14 × 8 in
<b>BWA-AH181610C</b>	Enclosure, Polycarbonate, with Clear Cover, 18 × 16 × 10 in

**Swing Panel Kits**

<b>BWA-AH66SPK</b>	Swing Panel Kit, 6 × 6 in, Includes Mounts, Screws, and Panel
<b>BWA-AH86SPK</b>	Swing Panel Kit, 8 × 6 in, Includes Mounts, Screws, and Panel
<b>BWA-AH108SPK</b>	Swing Panel Kit, 8 × 10 in, Includes Mounts, Screws, and Panel
<b>BWA-AH1210SPK</b>	Swing Panel Kit, 12 × 10 in, Includes Mounts, Screws, and Panel
<b>BWA-AH1412SPK</b>	Swing Panel Kit, 14 × 12 in, Includes Mounts, Screws, and Panel
<b>BWA-AH1614SPK</b>	Swing Panel Kit, 16 × 14 in, Includes Mounts, Screws, and Panel
<b>BWA-AH1816SPK</b>	Swing Panel Kit, 18 × 16 in, Includes Mounts, Screws, and Panel

**Back Panel Kits**

<b>BWA-BP66A</b>	Back Panel, aluminum, 6 × 6 in
<b>BWA-BP86A</b>	Back Panel, aluminum, 8 × 6 in
<b>BWA-BP108A</b>	Back Panel, aluminum, 8 × 10 in
<b>BWA-BP1210A</b>	Back Panel, aluminum, 12 × 10 in
<b>BWA-BP1412A</b>	Back Panel, aluminum, 14 × 12 in
<b>BWA-BP1614A</b>	Back Panel, aluminum, 16 × 14 in
<b>BWA-BP1816A</b>	Back Panel, aluminum, 18 × 16 in

(1) Enclosures, continued



#### Fiberglass Enclosures

BWA-EF14128	Enclosure Fiberglass Hinged 14 × 12 × 8 in
BWA-EF1086	Enclosure Fiberglass Hinged 10 × 8 × 6 in
BWA-EF866	Enclosure Fiberglass Hinged 8 × 6 × 6 in
BWA-PA1412	Panel, 14 × 12 in
BWA-PA108	Panel, 10 × 8 in
BWA-PA86	Panel, 8 × 6 in
BWA-PM12	Pole Mount, 12 in
BWA-PM8	Pole Mount, 8 in
BWA-PM6	Pole Mount, 6 in

#### Mounting Accessories

BWA-AHSNK	Slot Nut Kit, Includes 2 Nuts and 2 Screws
BWA-AHSPM	Swing Panel Mounts (4 per Kit)
BWA-AHLK	Latch Kit, 2 Latches per Kit, Replacement Only
BWA-AHAK	Accessory Kit, Includes all screws, inserts, and mounting feet (Replacement Only)
BWA-AHTBS	Screw 10-32 X .375 Phl Ph Zinc Self-threading

#### DIN Rail Kits

BWA-AH6DRK	DIN Rail Kit, 6 in, Includes 2 Nuts, 2 Screws, and DIN Rail
BWA-AH8DRK	DIN Rail Kit, 8 in, Includes 2 Nuts, 2 Screws, and DIN Rail
BWA-AH10DRK	DIN Rail Kit, 10 in, Includes 2 Nuts, 2 Screws, and DIN Rail
BWA-AH12DRK	DIN Rail Kit, 12 in, Includes 2 Nuts, 2 Screws, and DIN Rail
BWA-AH14DRK	DIN Rail Kit, 14 in, Includes 2 Nuts, 2 Screws, and DIN Rail
BWA-AH16DRK	DIN Rail Kit, 16 in, Includes 2 Nuts, 2 Screws, and DIN Rail
BWA-AH18DRK	DIN Rail Kit, 18 in, Includes 2 Nuts, 2 Screws, and DIN Rail

#### DIN Rail Kits

BWA-AH6DR	Din Rail Kit 6 in (Includes 2 Tribolar Screws and DIN Rail)
BWA-AH8DR	Din Rail Kit 8 in (Includes 2 Tribolar Screws and DIN Rail)
BWA-AH10DR	Din Rail Kit 10 in (Includes 2 Tribolar Screws and DIN Rail)
BWA-AH12DR	Din Rail Kit 12 in (Includes 2 Tribolar Screws and DIN Rail)
BWA-AH14DR	Din Rail Kit 14 in (Includes 2 Tribolar Screws and DIN Rail)
BWA-AH16DR	Din Rail Kit 16 in (Includes 2 Tribolar Screws and DIN Rail)
BWA-AH18DR	Din Rail Kit 18 in (Includes 2 Tribolar Screws and DIN Rail)

(2) Antennas



**Omni-Directional Antennas with RP-SMA Male Connections**

BWA-902-C	900 MHz	2 dBi, Rubber swivel (ships with 900 MHz radios)	
BWA-905-C		5 dBi, Rubber swivel	

BWA-202-C	2.4 GHz	2 dBi, Rubber swivel, 3 1/4 in (ships with 2.4 GHz radios)	
BWA-205-C		5 dBi, Rubber swivel, 6 1/2 in	
BWA-207-C		7 dBi, Rubber swivel, 9 1/4 in	

BWA-902-RA	900 MHz	2 dBi, Rubber fixed right-angle	
------------	---------	---------------------------------	--

BWA-201-001	2.4 GHz	1 dBi, Rubber, 1 inch tall	
-------------	---------	----------------------------	--

**Omni-Directional Dome Antennas**

BWA-902-D	900 MHz	2 dBi, 18 inch cable	RP-SMA Box Mount
-----------	---------	----------------------	------------------

BWA-202-D	2.4 GHz	2 dBi, 18 inch cable	RP-SMA Box Mount
-----------	---------	----------------------	------------------

**Other**

BWA-205-M	2.4 GHz	5 dBi, Magnetic whip antenna, 12 ft cable	RP-SMA Male
-----------	---------	---	-------------



(2) Antennas, continued



**Omnidirectional Fiberglass Antennas with N-Type Female Connections**

BWA-906-A	900 MHz	2 dBi, Rubber swivel (ships with 900 MHz radios)
BWA-208-A	2.4 GHz	8.5 dBi, Fiberglass, 24 in
BWA-206-A		6 dBi, Fiberglass, 16 in (shown)
BWA-906-AS	900 MHz	6 dBi, Fiberglass, 1/4 Wave, 23.6 in (1.3 inch diameter)
BWA-908-AS		8 dBi, Fiberglass, 3/4 Wave, 63 in (1.5 inch diameter)



**Directional (Yagi) Antennas with N-Type Female Connection**

BWA-9Y6-A	900 MHz	6.5 dBd, 6.8 × 13 inches Outdoor
BWA-9Y10-A	900 MHz	10 dBd, 6.8 × 24 inches Outdoor

(3) Antenna Cables



**Antenna Cables: RP-SMA to RP-SMA**

BWC-1MRSFRSB0.2	RG58, RP-SMA Male to RP-SMA Female Bulkhead, 0.2 m
BWC-1MRSFRSB1	RG58, RP-SMA Male to RP-SMA Female Bulkhead, 1 m
BWC-1MRSFRSB2	RG58, RP-SMA Male to RP-SMA Female Bulkhead, 2 m
BWC-1MRSFRSB4	RG58, RP-SMA Male to RP-SMA Female Bulkhead, 4 m
BWC-2MRSFRS3	LMR200, RP-SMA Male to RP-SMA Female, 3 m
BWC-2MRSFRS6	LMR200, RP-SMA Male to RP-SMA Female, 6 m
BWC-2MRSFRS9	LMR200, RP-SMA Male to RP-SMA Female, 9 m
BWC-2MRSFRS12	LMR200, RP-SMA Male to RP-SMA Female, 12 m



**Antenna Cables: RP-SMA to N-Type**

BWC-1MRSMN05	LMR100 RP-SMA to N-Type Male, 0.5 m
BWC-1MRSMN2	LMR100 RP-SMA to N-Type Male, 2 m



**Antenna Cables: N-Type**

BWC-4MNFN3	LMR400 N-Type Male to N-Type Female, 3 m
BWC-4MNFN6	LMR400 N-Type Male to N-Type Female, 6 m
BWC-4MNFN15	LMR400 N-Type Male to N-Type Female, 15 m
BWC-4MNFN30	LMR400 N-Type Male to N-Type Female, 30 m



(4) Surge Suppressors



BWC-LFNBMN-DC

Surge Suppressor, bulkhead, N-Type Female, N-Type Male, dc Blocking



BWC-LMRSFRPB

Surge Suppressor, bulkhead, RPSMA to RP-SMA

(5) Power Supplies

DC Power Supplies



PS24W

DC Power Supply, 500 mA, 24 V dc, Demo kit power supply



PSDINP-24-06

DC Power Supply, 0.63 Amps, 24 V dc, with DIN Rail Mount, Class I Division 2 (Groups A, B, C, D) Rated

PSDINP-24-13

DC Power Supply, 1.3 Amps, 24 V dc, with DIN Rail Mount, Class I Division 2 (Groups A, B, C, D) Rated

PSDINP-24-25

DC Power Supply, 2.5 Amps, 24 V dc, with DIN Rail Mount, Class I Division 2 (Groups A, B, C, D) Rated

FlexPower Supplies and Replacement Batteries



DX81-LITH

Battery Supply Module with mounting hardware



DX81H

Battery Supply Module with mounting hardware, for DX99 polycarbonate housing

DX81P6

Battery Supply Module, six "D" cells, with mounting hardware



BWA-BATT-001

Lithium "D" cell, single, for DX81-LITH and DX81H Battery Supply Module

BWA-BATT-006

Lithium "AA" cell, single, for Wireless Q45 Sensors for DX81x models

## (5) Power Supplies, continued



## Solar Panels

BWA-SOLAR PANEL 3W	Solar Panel, 12 V, 3 W, Multicrystalline, 188 × 195 × 15, Wall/Pole clamp style mounting bracket included
BWA-SOLAR PANEL 5W	Solar Panel, 12 V, 5 W, Multicrystalline, 270 × 222 × 17, Wall/Pole clamp style mounting bracket included
BWA-SOLAR PANEL 20W	Solar Panel, 12 V, 20 W, Multicrystalline, 573 × 357 × 30, "L" mounting bracket included
BWA-SOLAR CNTRL-12V	Solar Controller, 6 A Load Current 12 V System Voltage, recommended for 20 watts or less solar panel AND Sealed Lead Acid Battery (SLA)

## Relays



IB6RP	Interface Relay Box, 18 to 26 V dc inputs, isolated relay outputs (not shown)
BWA-RELAY-12V	Relay, Blade Style with Base, 12 V
BWA-RELAY-24V	Relay, Blade Style with Base, 24 V
BWA-RH1B-UDC12V	Relay, Blade Style, No Base, 12 V (replacement part)
BWA-RH1B-UDC24V	Relay, Blade Style, No Base, 24 V (replacement part)
BWA-SH1B-05	Relay Base Only (replacement part)

(6) Brackets

Mounting Kit

<p><b>BWA-HW-001</b></p>	<ul style="list-style-type: none"> <li>• Screw, M5-0.8 x 25 mm, SS (4)</li> <li>• Screw, M5-0.8 x 16 mm, SS (4)</li> <li>• Hex nut, M5-0.8 mm, SS (4)</li> <li>• Bolt, #8-32 x 3/4-in, SS (4)</li> </ul>
--------------------------	--

Brackets



<p><b>SMBDX80DIN</b></p>	<ul style="list-style-type: none"> <li>• Black reinforced thermoplastic bracket for mounting on a 35 mm DIN rail</li> </ul>
--------------------------	---



<p><b>BWA-HW-034</b></p>	<ul style="list-style-type: none"> <li>• DIN rail clip, black plastic</li> <li>• Used with the M-HBx MultiHop and -PBx Performance board modules</li> </ul>
--------------------------	---



Hole center spacing: A = 26.0, A to B = 13.0  
 Hole size: A = 26.8 x 7.0, B = ø 6.5, C = ø 19.0

<p><b>SMBAMS18RA</b></p>	<ul style="list-style-type: none"> <li>• Right-angle SMBAMS series bracket with 18 mm hole</li> <li>• Articulation slots for 90+° rotation</li> <li>• 12-ga. (2.6 mm) cold-rolled steel</li> </ul>
--------------------------	--



Hole center spacing: 35.1  
 Hole size: 25.4 x 5.3

<p><b>DIN-35-70 = 70 mm</b>  <b>DIN-35-105 = 105 mm</b>  <b>DIN-35-140 = 140 mm</b></p>	<ul style="list-style-type: none"> <li>• 35 mm DIN Rail</li> </ul>
---	--

Cables

**Ethernet Cables**

Use a crossover cable to connect the GatewayPro or DX83 Ethernet Bridge to a host system without using an Ethernet switchbox or hub. When using a switchbox or hub, use a straight cable.

BWA-E2M	Ethernet cable, RSCD RJ45 440, 2 m
BWA-E8M	Ethernet cable, RSCD RJ45 440, 8 m
BWA-EX2M	Ethernet cable, crossover, RSCD RJ45CR 440, 2 m

**Adapter Cables**



BWA-HW-006	Adapter cable, USB to RS-485, for use with the User Configuration Tool software (UCT)
BWA-UCT-900 (shown)	Adapter cable with power, USB to RS-485, for use with the User Configuration Tool software (UCT), supplies power to 1 Watt radios

**Splitter Cables**

Use **CSRB-M1250M125.47M125.73** to split power between two *FlexPower*® or solar powered devices. DO NOT use this cable to connect a *FlexPower* devices to a 10 to 30 V dc powered device.

Use **CSRB-M1253.28M1253.28M1253.28** to connect one *FlexPower* device (data radio, *FlexPowered* Gateway, etc) to two power sources, such as the *FlexPower* Solar Supply and **DX81P6** Battery Pack.

Model	Length	Style	Pinout
CSRB-M1250M125.47M125.73	<b>Trunk:</b> 0 m (male) <b>Branches:</b> 0.14 m and 0.22 m (female)	Straight	<p>1 = Brown 2 = White 3 = Blue 4 = Black 5 = Green/Yellow</p>
CSRB-M1253.28M1253.28M1253.28	<b>Trunk:</b> 1 m (female) <b>Branches:</b> 1 m (male)		

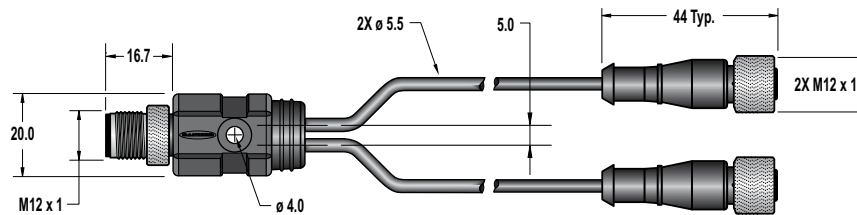

Cordsets

**Euro-Style — Single-Ended**

When facing the Node or Gateway toward you and the quick-disconnect connection is facing down, the right-angle cables exit to the right.

When using the *FlexPower*® Node with integrated battery, use a double-ended cordset. When using a *FlexPower* Node with external power supply, use a single-ended cordset. If using the communication lines, the cable length cannot exceed 3 meters (10 ft).

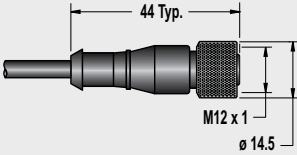
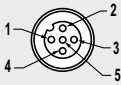
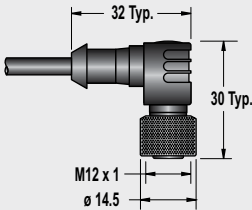
Model	Length	Style	Dimensions	Pinout
MQDC1-501.5	0.50 m (1.5 ft)	Straight		<p>Female</p>  <p>1 = Brown 2 = White 3 = Blue 4 = Black 5 = Gray</p>
MQDC1-506	1.83 m (6 ft)			
MQDC1-515	4.57 m (15 ft)			
MQDC1-530	9.14 m (30 ft)			
MQDC1-506RA	1.83 m (6 ft)	Right-Angle		
MQDC1-515RA	4.57 m (15 ft)			
MQDC1-530RA	9.14 m (30 ft)			

Model	Length	Style	Description
BWA-QD5.5	—	—	Prewired 5-pin Euro connector, 1/2-14 NBSM
BWA-QD8.5	—	—	Prewired, 8-pin Euro connector, 1/2-14 NBSM
BWA-QD12.5	—	—	Prewired 12-pin Euro connector, 1/2-14 NBSM
FIC-M12F4	—	Straight	Euro-Style Field-Wireable Connector 4-pin Female Straight
MQDMC-401	0.5 m	Straight	Cordset, 4-pin Euro-style, single ended, male, longer pigtailed for DX80...C models

Cordsets, continued

**Euro-Style — Double-Ended**

When using the *FlexPower*® Node with integrated battery, use a double-ended cordset. When using a *FlexPower* Node with external power supply, use a single-ended cordset. If using the communication lines, the cable length cannot exceed 3 meters (10 feet).

Model	Length	Style	Dimensions	Pinout
DEE2R-51D	0.31 m (1 ft)	Female Straight/ Male Straight		<p>Male</p> <p>Female</p> <p>1 = Brown 2 = White 3 = Blue 4 = Black 5 = Green/Yellow</p>
DEE2R-53D	0.91 m (3 ft)			
DEE2R-58D	2.44 m (8 ft)			

**Other Cordsets**

BWA-RIBBON-001	Ribbon cable, 20-pin DBL socket
BWA-HW-010	Cable, <i>FlexPower</i> Current Monitoring

Hardware and Replacement Parts

Model	Description
BWA-HW-002	<b>DX80 Access Hardware Kit:</b> Plastic threaded plugs, PG-7 (4) Nylon gland fittings, PG-7 (4) Hex nuts, PG-7 (4) Plug, 1/2-in NPT Nylon gland fitting, 1/2-in NPT
BWA-HW-003	PTFE Tape, 1/4-in wide, 600-in long
BWA-HW-004	<b>Replacement Seals:</b> O-ring, rotary access cover, PG21 (2) O-ring, body gasket (2) Access cover, rotary dials, clear plastic (2)
BWA-HW-009	Solar assembly hardware pack, includes brackets, bolts, and set screws
BWA-HW-007	Housing Kit, DX80, top and bottom, 10 pieces
BWA-HW-008	Housing Kit, DX81, top and bottom, 10 pieces
BWA-HW-044	Terminal header for the MultiHop Ethernet Data Radio
BWA-HW-011	Terminal Block Headers, IP20, 2 pack
BWA-HW-012	<b>DX99 Antenna Extension Pack:</b> Screw, M4-0.7 x 20, pan head, black steel Flexible Antenna Cable, 12 in, SMA male to SMA female
BWA-HW-032	Access hardware for the E housing, one 1/2-in plug, one 1/2-in gland
BWA-HW-037	Clear plastic retaining ring for DX99 metal housings, 10 pack

Replacement Filters



Model	Description
FTH-FIL-001	Aluminum grill filter cap (factory default, ships with M12FT*Q sensors)

FTH-FIL-002	Stainless steel, sintered to 10 micrometer porosity (for high dust environments)
-------------	--

Cable Glands and Plugs

Model	Description
BWA-HP5-10	Dummy Hole Plugs, 1/2-in NPT, 10 pieces
BWA-HW-031	Vent Plug, 1/2-in NPT, IP67
BWA-CG.5-10	Cable Glands, 1/2-in NPT, Cordgrip for 3 holes of 2.8 to 5.6 mm diameter, 10 Pack
BWA-CG.5-3X5.6-10	Solar assembly hardware pack, includes brackets, bolts, and set screws
BWA-CG.5-2X2.5-10	Cable Glands, 1/2-in NPT, Cordgrip for 2 holes of 1.2 to 2.5 mm diameter, 10 Pack
BWA-CG.5-6X4.0-10	Cable Glands, 1/2-in NPT, Cordgrip for 6 holes of 2 to 4 mm diameter, 10 Pack
BWA-CG.5-6X3.0-10	Cable Glands, 1/2-in NPT, Cordgrip for 6 holes of 1.5 to 3 mm diameter, 10 Pack

Metal Housing Accessories



Model	Description
BWA-HW-016	Antenna Feedthrough, Stainless Steel, 1/2-in NPT
BWA-HW-017	Antenna Feedthrough, Stainless Steel, 3/4-in NPT
BWA-HW-012	DX99 Antenna Extension Pack (M4-0.7 x 20 black steel pan head screw, flexible antenna cable 12-in SMA male to SMA female)
BWA-HW-037	Clear plastic retaining ring for DX99 metal housings (10 pack)
BWA-AXFS0130	AXF™ Explosion-Proof Antenna Coupler

Omni-Directional Dome Antennas



Models	Frequency	Description	Connection
BWA-902-001	900 MHz	2 dBi, 18 inch cable	1/2-in SS NPT Port
BWA-902-002			3/4-in SS NPT Port
BWA-202-001	2.4 GHz		1/2-in SS NPT Port
BWA-202-002			3/4-in SS NPT Port



## OTHER AVAILABLE MODELS



Q45 Wireless

[see website](#)

Sure Cross® Wireless Q45 Sensors combine the best of Banner's flexible Q45 sensor family with its reliable, field-proven, Sure Cross® wireless architecture.



## Safety

Banner produces a wide range of safety-related products, including safety light screens, safety interlock switches, e-stop modules and two-hand control safety modules that protect personnel and equipment.

# SAFETY

---

LIGHT SCREENS **page 552**

CONTROLLERS **page 582**

EMERGENCY STOP &  
STOP CONTROL **page 609**

INTERLOCK SWITCHES **page 640**

TWO-HAND CONTROL **page 680**

LASER SCANNERS **page 692**

MODULES **page 698**

## Safeguarding Basics

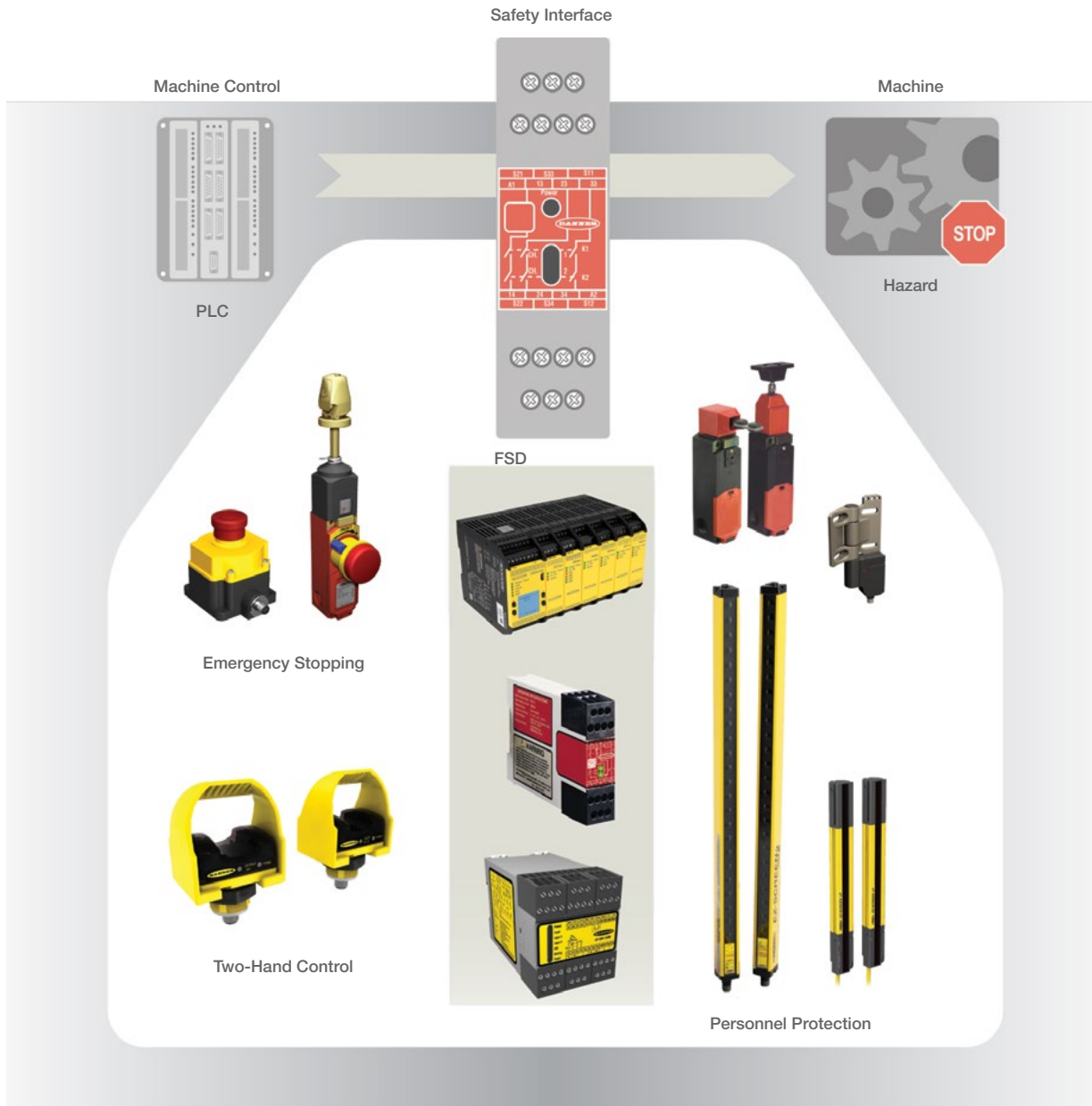
**Basics of Safeguarding**

Machine and personnel safeguarding refers to the combination of requirements, methods and solutions used to protect people who come in contact with dangerous machines in the industrial environment.

**Requirements**

National and regional governmental bodies have regulations, mandates, standards and recommendations for implementing a safety method or a solution.

Key regulations regarding general machine guarding include the following:

- Machinery Directive - EU
- OSHA General Duty Clause – USA

**Device Requirements**

Safety devices must be able to consistently and reliably bring a machine hazard to an orderly stop.

To be considered a safety device, the following methods must be used to ensure reliable operation: fault exclusion, redundancy and self-checking.

**Safety Circuit Requirements**

A safety stop circuit typically comprises 2 normally-open contact from mechanically-linked relays. The circuit is monitored to detect certain failures that could lead to the loss of the safety function.

# Methods: Risk Assessment

The Risk Assessment Process in machine safeguarding is a process used to identify hazards through each phase of the machine's life cycle and to minimize dangers to personnel and equipment.

### The basic steps in a Risk Assessment Process:

1. Identify hazards and where they occur.
2. Assess risk by severity of harm and probability of occurrence.
3. Reduce the risk through the use of protective measures.
4. Validate and document results.

### Risk Assessment Standards

- OSHA 3071, Job Hazard Analysis
- MIL-STD-8820, US DOD System Safety Program
- ANSI B11.0 General (Safety) Requirements and Risk Assessment
- ISO 12100, General Principles for Design, Risk Assessment and Risk Reduction
- SEMI S10, Risk Assessment, Semiconductor Manufacturing Equipment







# Methods: Safety Circuits

Depending on the level of risk associated with the machine or operations, an appropriate level of control circuitry performance must be incorporated into safety device design.

	Basic	Single	Single with Monitoring	Dual with Monitoring
	<p><b>Stop Command</b></p>	<p><b>Protective Command</b></p>	<p><b>Protective Command Monitoring Signal</b></p>	<p><b>Redundant (Safety) Stop Commands Monitoring Signal</b></p>
Generic	<ul style="list-style-type: none"> <li>• Non safety-rated components</li> <li>• Integrated in accordance with relevant standards</li> <li>• Reliability depends on robust components</li> <li>• Redundancy not required</li> </ul>	<ul style="list-style-type: none"> <li>• Safety-rated components</li> <li>• Integrated in accordance with safety principles and design</li> <li>• Redundancy not required</li> </ul>	<ul style="list-style-type: none"> <li>• Safety-rated components</li> <li>• Conducts periodic test of system</li> <li>• Normal operation allowed if no faults are found</li> <li>• If unsafe fault is found, system will default to safe state or indicate that unsafe system exists</li> </ul>	<ul style="list-style-type: none"> <li>• Safety-rated components</li> <li>• Greatest degree of fault tolerance</li> <li>• Redundancy and self-checking</li> <li>• Single failure cannot cause loss of safety function</li> <li>• Faults detected immediately or at next demand on system</li> </ul>
Fault	Possible loss of safety function	Greater reliability, but possible loss of safety function	Fault detected at each test	Safety function is ensured with a single fault. An accumulation of faults is detected or not possible.
Risk	<b>Very Low</b> Minor bump or bruise with no lost time	<b>Low</b> Minor first aid, infrequent exposure or high likelihood of avoiding the hazard	<b>Mid Range</b> Injuries that are slight or normally reversible, requiring normal healing or only first aid	<b>High or Very High</b> Normally reserved for hand-fed applications where injuries could be severe to irreversible
ANSI / B11	—	—	—	Control Reliable ANSI B11.19 (Clause 6.1 and Annex C) Category 3 or 4 and/or PL d or PL e per ISO 13849-1 satisfy Control Reliability requirements
ANSI / RIA	Simple	Single Channel	Single Channel with Monitoring	Typically, a minimum of PL=d with Category 3 per ISO 13849-1:2006 or control reliable (see ANSI B11.1.TR6 or ANSI B11.19)
ISO / EN	Category B ISO 13849-1/EN 954-1	Category 1 ISO 13849-1/EN 954-1	Category 2 ISO 13849-1/EN 954-1	Category 3 & 4 ISO 13849-1/EN 954-1



## Solutions: Comparing Guards and Devices\*

Type	Safety Function	Advantages	Limitations	Requirements	Standards
<b>Guards: protective physical barrier used to prevent access.</b>					
Fixed Guard 	Provides a fixed barrier to the hazard	<ul style="list-style-type: none"> <li>• Low maintenance</li> <li>• Long life</li> <li>• Low cost for small areas</li> <li>• Protects all individuals</li> <li>• Can contain ejected materials</li> </ul>	<ul style="list-style-type: none"> <li>• Poor ergonomics</li> <li>• Limited visibility</li> <li>• Limited access</li> <li>• Costly for large areas</li> <li>• Maintenance may require removal of guard</li> </ul>	<ul style="list-style-type: none"> <li>• Protect from identified hazard</li> <li>• Prevent user from reaching over, under, around or through the barrier</li> <li>• Provide safe openings</li> </ul>	<ul style="list-style-type: none"> <li>• ANSI B11.19</li> <li>• ISO 14120</li> <li>• ISO 13857</li> </ul>
Interlocked Guard 	Interrupts power to machine when guard is opened	<ul style="list-style-type: none"> <li>• Low initial investment</li> <li>• Can be placed close to hazard</li> <li>• Protects all individuals</li> <li>• Can contain ejected materials</li> </ul>	<ul style="list-style-type: none"> <li>• Costly for large areas</li> <li>• Increased maintenance</li> </ul>	<ul style="list-style-type: none"> <li>• Must be difficult to defeat</li> <li>• Guard may open only after machine has stopped—or must be installed at a safe distance</li> </ul>	<ul style="list-style-type: none"> <li>• ANSI B11.19</li> <li>• NFPA 79</li> <li>• ISO 14119</li> <li>• ISO 14120</li> <li>• IEC 60204-1</li> <li>• ISO 13857</li> <li>• ISO 13855</li> </ul>
<b>Safeguarding Devices: components, attachments or mechanisms designed to perform a specific safeguarding function.</b>					
Safety Light Screen 	Arrests power to machine when sensing field is interrupted	<ul style="list-style-type: none"> <li>• Excellent ergonomics</li> <li>• Allows frequent access</li> <li>• Protects all individuals</li> <li>• Cost effective for large areas</li> <li>• Allows for good visibility</li> </ul>	<ul style="list-style-type: none"> <li>• Limited to machines that can be stopped quickly</li> <li>• No protection from ejected parts</li> <li>• May require the use of additional guards</li> <li>• May create a pass-through hazard</li> </ul>	<ul style="list-style-type: none"> <li>• Initiate immediate stop when sensing field is interrupted</li> <li>• Appropriate resolution required to detect objects the size of a torso, ankle, hand or finger</li> </ul>	<ul style="list-style-type: none"> <li>• ANSI B11.19</li> <li>• IEC 61496</li> <li>• ISO 13855</li> </ul>
Multiple-Beam System: <ul style="list-style-type: none"> <li>• Grids</li> <li>• Points</li> </ul> 	Arrests power to machine when sensing field is interrupted	<ul style="list-style-type: none"> <li>• Low initial investment</li> <li>• Allows frequent access</li> <li>• Allows for good visibility</li> <li>• Protects all individuals</li> </ul>	<ul style="list-style-type: none"> <li>• Limited to machines that can be stopped quickly</li> <li>• No protection from ejected parts</li> <li>• Large safety distance</li> <li>• May create a pass-through hazard</li> </ul>	<ul style="list-style-type: none"> <li>• Initiate immediate stop when sensing field is interrupted</li> <li>• Appropriate resolution required to detect objects the size of a torso</li> </ul>	<ul style="list-style-type: none"> <li>• ANSI B11.19</li> <li>• IEC 61496</li> <li>• ISO 13855</li> </ul>
Two-Hand Control 	Operator must use both hands to actuate machine motion hereby preventing operator access to hazardous area	<ul style="list-style-type: none"> <li>• Operator's hands are away from hazardous area</li> <li>• Low initial investment</li> <li>• Low maintenance</li> </ul>	<ul style="list-style-type: none"> <li>• Potential ergonomic impact</li> <li>• Provides protection only for operator</li> <li>• No protection from ejected parts</li> </ul>	<ul style="list-style-type: none"> <li>• Concurrent actuation within 1/2 second</li> <li>• Release and reactivation required before machine motion may be reinitiated</li> </ul>	<ul style="list-style-type: none"> <li>• ANSI B11.19</li> <li>• NFPA 79</li> <li>• ISO 13851</li> <li>• IEC 60204-1</li> <li>• ISO 13855</li> </ul>
Safety Mat Monitor 	Interrupts power to machine when a minimum pressure is applied	<ul style="list-style-type: none"> <li>• Excellent ergonomics</li> <li>• Protects all individuals</li> <li>• Allows for good visibility</li> </ul>	<ul style="list-style-type: none"> <li>• Costly for large areas</li> <li>• Maintenance intensive</li> <li>• Large safety distance</li> </ul>	Minimum object sensitivity of 66 lbs on and 3-1/8" surface to detect a foot	<ul style="list-style-type: none"> <li>• ANSI B11.19</li> <li>• ISO 13855</li> <li>• ISO 13856</li> </ul>
<b>Complementary (Safety) Equipment: used to supplement/augment safeguarding.</b>					
E-Stop <ul style="list-style-type: none"> <li>• Button</li> <li>• Rope Pull</li> </ul>  	Operator activates button in emergency situation to shut off power to machine	<ul style="list-style-type: none"> <li>• Immediate response</li> <li>• Safe shutdown of machine process</li> </ul>	<ul style="list-style-type: none"> <li>• Not considered a safeguard</li> <li>• Requires conscious act of operator</li> <li>• Limits injury or machine damage but typically does not prevent it</li> </ul>	<ul style="list-style-type: none"> <li>• Overrides all other functions and operations</li> <li>• Reset of E-stop doesn't initiate machine motion</li> <li>• Button must be red with yellow background</li> <li>• Should be located at each operation station</li> <li>• Final removal of power done by electromechanical components</li> </ul>	<ul style="list-style-type: none"> <li>• ANSI B11.19</li> <li>• NFPA 79</li> <li>• ISO 12100</li> <li>• IEC 60204-1</li> <li>• ISO 13850</li> </ul>

\*This represents a partial list of available safeguards & devices.

# Solutions: Choosing and Locating a Safeguard

When choosing a safeguard, ask yourself the following questions:

1) is it safe, 2) is it legal and 3) does it make sense for the application?

## Choosing a Safety Product

- Who will use it?
- How will they use it?
- What hazards are associated with which task?
- What are the types of hazards?
- Where will the safeguard be located?

Guarding Solutions	Maintenance \$	Frequent Access	Infrequent Access	Locate Close to Hazard	Long Machine Stop Time	Ergonomic	Visibility	Multiple Operators	Guards Against Ejected Material	Comments
Fixed Hard Guard	P	P	E	E	E	P	P	E	E	<ul style="list-style-type: none"> <li>Limited access</li> <li>Limited visibility to the machine</li> <li>Costly for large areas</li> <li>Costly to maintain and fix</li> </ul>
Locking Guard	P	P	E	E	E	P	P	E	E	
Interlock Guard	P	P	A	E	A	P	P	E	E	
Two-Hand Control	A	A	A	A	A	A	A	P	P	<ul style="list-style-type: none"> <li>Only protects operator(s)</li> </ul>
High-Resolution SLS	E	E	P	E	P	E	E	E	X	<ul style="list-style-type: none"> <li>Locate closer to hazard</li> </ul>
Low-Resolution SLS	E	E	P	E	P	E	E	E	X	<ul style="list-style-type: none"> <li>Costs less than high resolution SLS</li> </ul>
3- or 4-Beam Perimeter	E	A	A	P	A	E	E	E	X	<ul style="list-style-type: none"> <li>Takes less space than 2-beam</li> </ul>
2-Beam Perimeter	E	A	A	P	A	E	E	E	X	<ul style="list-style-type: none"> <li>Costs less than 3- or 4-beam</li> </ul>
Safety Mats	P	A	A	P	A	E	E	E	X	<ul style="list-style-type: none"> <li>Maintenance-intensive</li> </ul>

## Locating a Safety Product

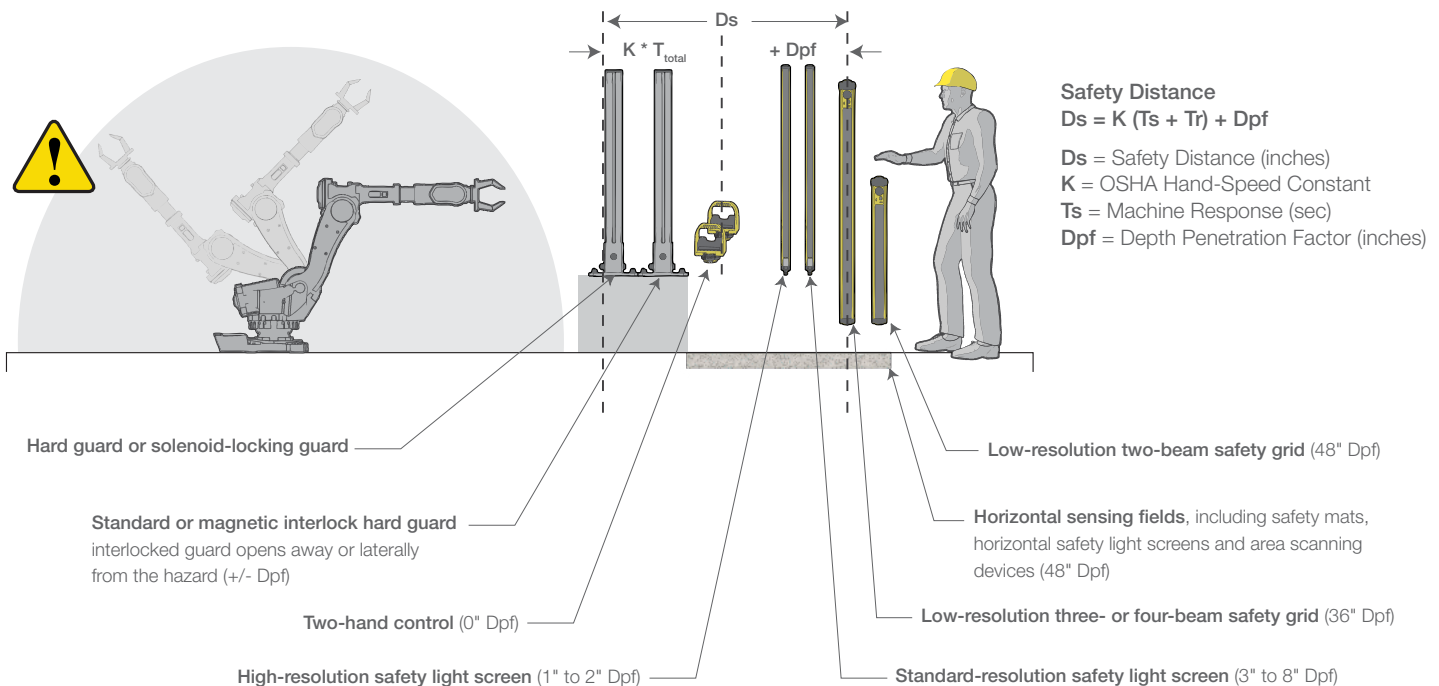

NOTE: Illustration examples are based upon the described safeguards being used as the primary safeguarding device, all examples having identical stopping time, and following generally accepted industrial engineering practices that are found within ANSI B11.19 safety standard.



#### EZ-SCREEN Safety Light Screens

- Type 4 models exceed control reliability requirements
- Type 2 models available for lower-risk applications
- Available in standard or cascadable models and with integrated muting



#### TL70 Modular LED Tower Light

- Up to five colors plus an audible module in one device
- Bright, easy-to-see indicator segments for clear status indication
- Segments appear gray when OFF to eliminate false indication from ambient light



#### XS26-2 Expandable Safety Controller

- Up to eight expansion I/O modules can be added as your safety application grows or changes
- Begin programming right away using our intuitive, easy-to-use configuration software
- Simulator functionality allows users to test their configurations without being connected to a controller



#### Two-Hand Control

- Ergonomic design reduces risk of repetitive strain injury
- Optional run bar stand
- Add EZ-LIGHTs for status indication in lean manufacturing
- Provides highest level of safety for two-hand control input devices





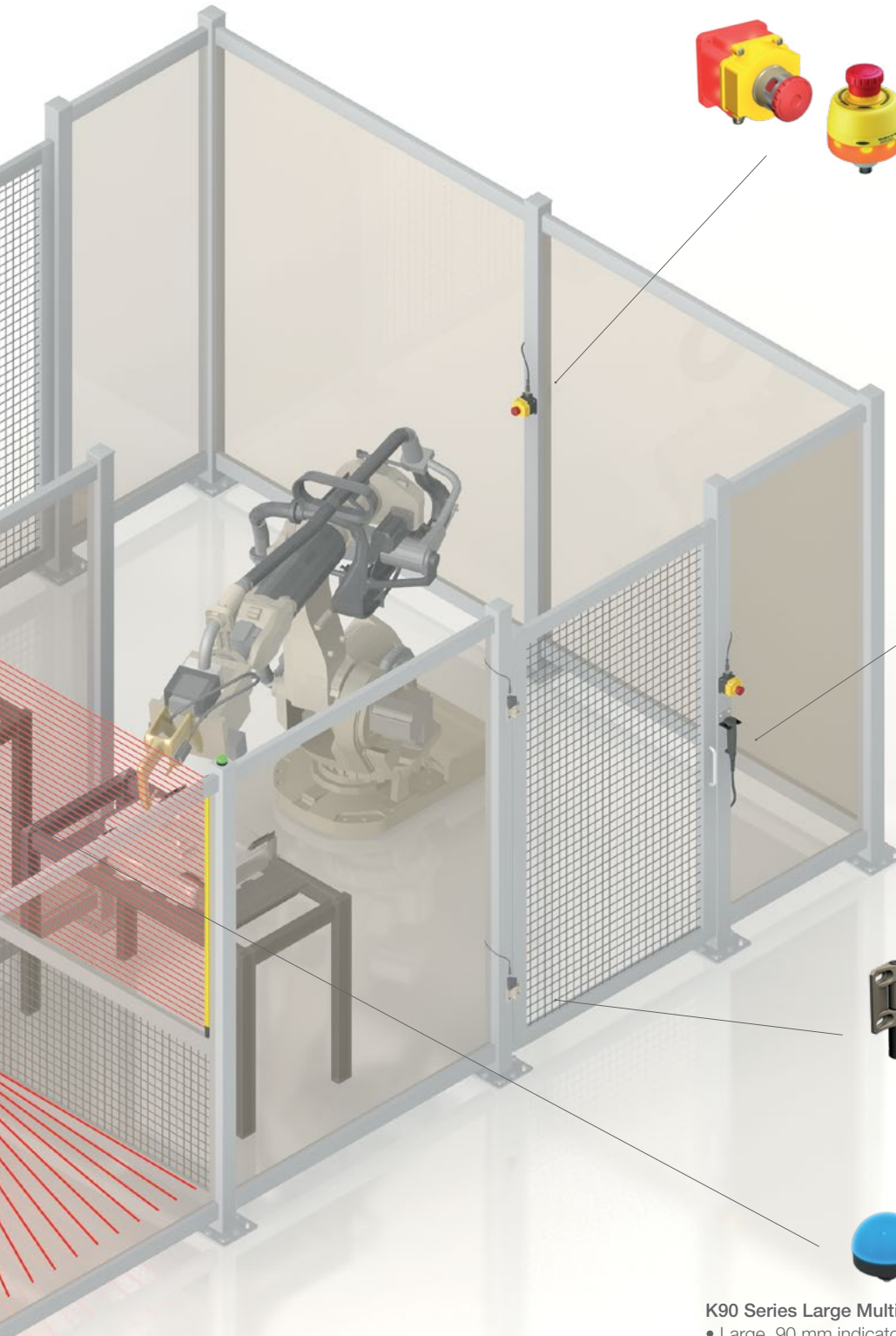

**Emergency Stop and Stop Control**

- Available as panel mount or as pre-assembled enclosures
- Illuminated models help operators quickly identify actuated buttons
- Easy-to-mount enclosures install using M12 cables for quick wiring



**Enabling Devices**

- Provides safety function when user either squeezes or releases the handle grip switch
- Ergonomic design with a detented enable position



**Safety Interlock Switches**

- Load bearing hinge switch with 270° range
- Safety switching point is adjustable and repositionable
- Stainless or zinc die-cast



**K90 Series Large Multicolor EZ-LIGHT**

- Large, 90 mm indicator lights provide extremely bright and uniform illumination from all directions and over longer distances
- Up to five colors in a single device
- Rugged IP67 design

**Safety Scanner**

- Two-dimensional laser scanner with easy-to-use software
- Programming of irregular shaped warning and detection zones
- 190° scanning angle with selectable resolutions (30 mm, 40 mm, 50 mm, 70 mm and 150 mm) and a 4 m or 6.25 m range



---

## Light Screens

Safety light screens protect personnel from injury and machines from damage by guarding points of operation, access, areas and perimeters. Type 4 safety light screens provide control reliability and high levels of fault tolerance and Type 2 safety light screens are cost effective for guarding lower-risk applications.

Series	Description	Max. Sensing Range	Defined Area	Safety Rating	Dimensions H x W x D	Power Supply
	<b>EZ-SCREEN®</b> Two-piece system with 14 or 30 mm resolution provides finger, hand and ankle detection. page 556	<b>14 mm:</b> 6 m <b>30 mm:</b> 18 m	150 to 1800 mm 150 to 2400 mm	Type 4 /Category 4/PLe	H (varies by model) 35 x 45.2 mm	24 V dc
	<b>EZ-SCREEN® LS</b> Intuitive, easy-to-use safety light screens with 14, 23, and 40 mm resolution to provide finger, hand and ankle detection. page 560	12 m	280 to 1820 mm	Type 4 /Category 4/PLe	H (varies by model) 45 x 42.5 mm	24 V dc
	<b>EZ-SCREEN® LP</b> Two-piece system with 14 or 25 mm resolution provides finger, hand and ankle detection. page 564	<b>14 or 25 mm:</b> 7 m	270 to 1810 mm	Type 4 /Category 4/PLe	H (varies by model) 28 x 26 mm	24 V dc
	<b>EZ-SCREEN® Grids</b> Two-piece perimeter guarding system with up to four beams of torso detection. page 572	70 m	500 to 1066 mm	Type 4 /Category 4/PLe	H (varies by model) 52 x 55 mm	24 V dc
	<b>EZ-SCREEN® Points</b> Two-piece perimeter guarding system with 1 beam of torso detection. page 573	70 m	25 mm beam diameter	Type 4 /Category 4/PLe	149 x 52 x 55 mm	24 V dc
	<b>EZ-SCREEN® Type 2</b> Suited for lower risk applications where the result is only a slight injury. page 578	15 m	150 to 1800 mm	Type 2 /Category 2/PLe	H (varies by model) 25.2 x 31.8 mm	24 V dc

# Choosing a Safety Light Screen Model

Select  
Hazard  
Level

# 1

## Type 4

Protect personnel from injury and machines from damage by guarding points of operation, access, areas and perimeters. With self-checking circuitry, Type 4 light curtains provide control reliability and high levels of fault tolerance.

Select  
Resolution

# 2

### Finger

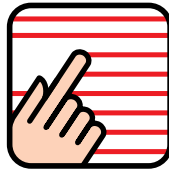

14 mm resolution  
for finger, hand and  
ankle detection

### Hand

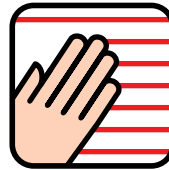

lower resolution  
for hand and  
ankle detection

### Body



2, 3, or 4 beams  
to protect personnel  
and machinery

Select  
Housing

# 3

### Standard



Non-contact machine guarding systems protect fingers, hands and ankles, and guard perimeters and access, using self-contained emitters and receivers without a separate control box. See page 556

### LS



The Lean & Simple design combines Machine Safety and the notion of Lean Manufacturing by focusing on features that provide high-value for most applications while eliminating those that unnecessarily add cost and complicate the installation, use, and maintenance of the device. See page 560

### Low-Profile



The space-saving, compact profile is ideal for smaller machines, yet robust enough to meet the demands of large power presses. See page 564

### Grids & Points



Point and Grid systems allow one-, two-, three- or four-beam perimeter and access guarding. See page 572

Select Hazard Level

1

**Type 2**

Used for lower-risk applications, where the result of an accident is only a slight injury. Type 2 Light curtains feature a large field of view and use fault exclusion to ensure the integrity of safeguarding.

Select Resolution

2

**Hand/Body**

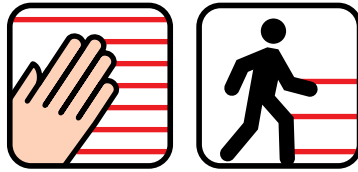

30 mm resolution for bump, bruise or knock-down detection

Select Housing

3

**Standard**



Inexpensive, compact optical safeguarding solution designed for lower-risk applications where risk of injury is limited but some guarding is necessary. See page 578

## EZ-SCREEN®

## Safety Light Screens

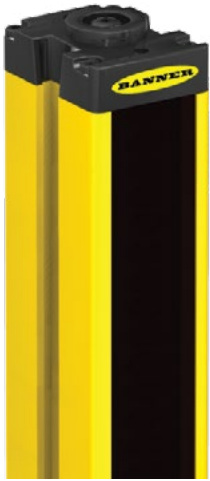

- EZ-SCREEN® point-of-operation systems provide finger, hand and ankle detection in a robust housing and metal endcaps.
- Operating range up to 18 m
- Displays operating status, configuration error codes, and blocked beams
- Exceeds OSHA/ANSI Control Reliability requirements, certified to cULus NIPF, and CE certified to Type 4, Cat 4 PLe, and SIL3
- Resists impact, twisting, and abusive environments with durable aluminum housing or nickel-plated ESD-safe housing for protection against electrostatic discharges
- Available in 14 or 30 mm resolution
- Cordsets and brackets see page 578

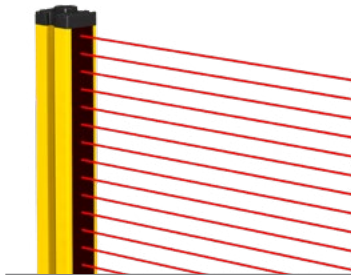
**14 mm Resolution**

14 mm resolution safety light screens can be used for finger, hand and ankle protection.

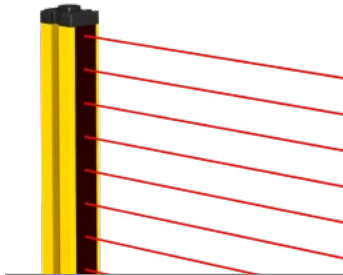
**30 mm Resolution**

30 mm resolution safety light screens can be used for hand and ankle protection.

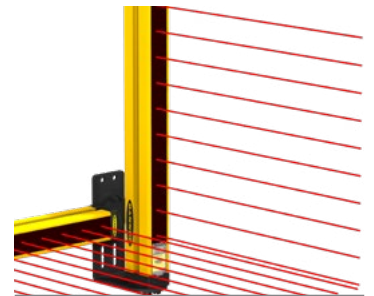
**Cascade**

Cascading models allow four systems of any length and resolution to be connected in a series, forming a single safety device.

**Some of the Available Finishes**

Yellow Painted  
Aluminum



Clear Anodized  
Aluminum



Nickel-Plated  
ESD

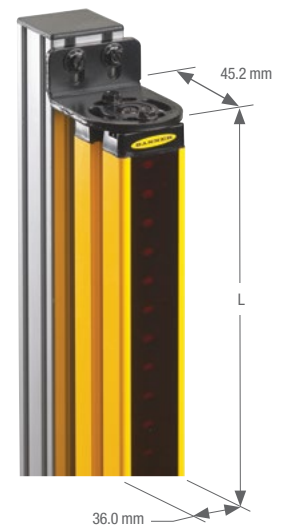

EZ-SCREEN Systems

EZ-SCREEN® Systems, Non-Cascade

Example Model Number SLSP14-150Q88

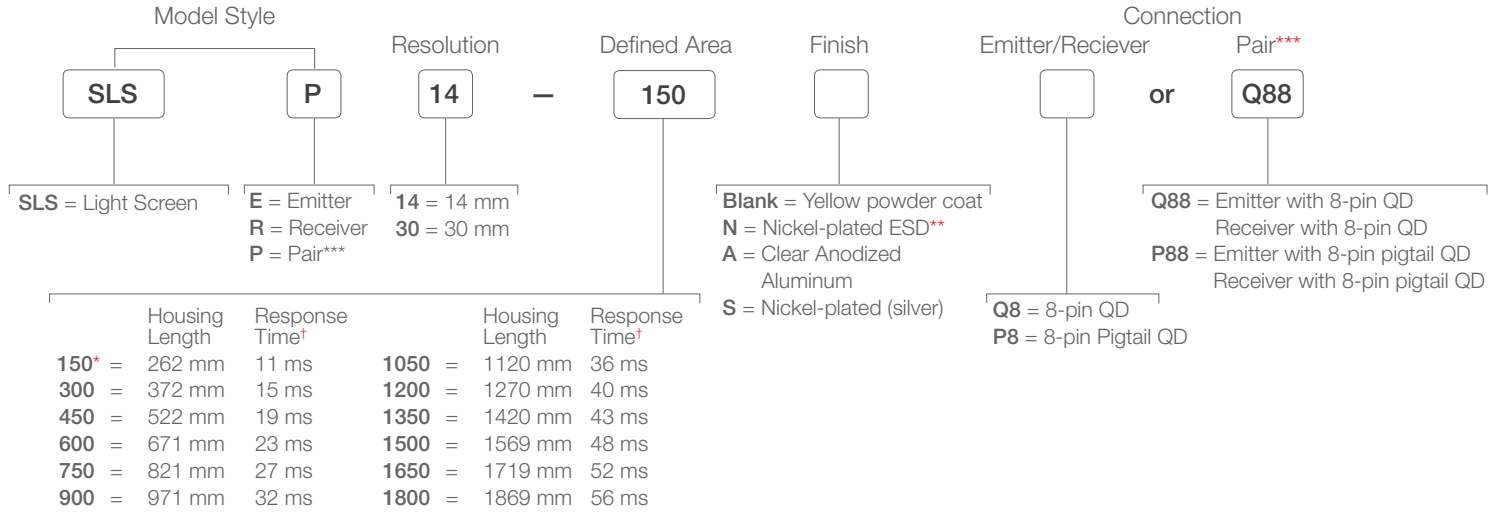

EZ-SCREEN® Systems, Cascade

Example Model Number SLSCP30-150Q88

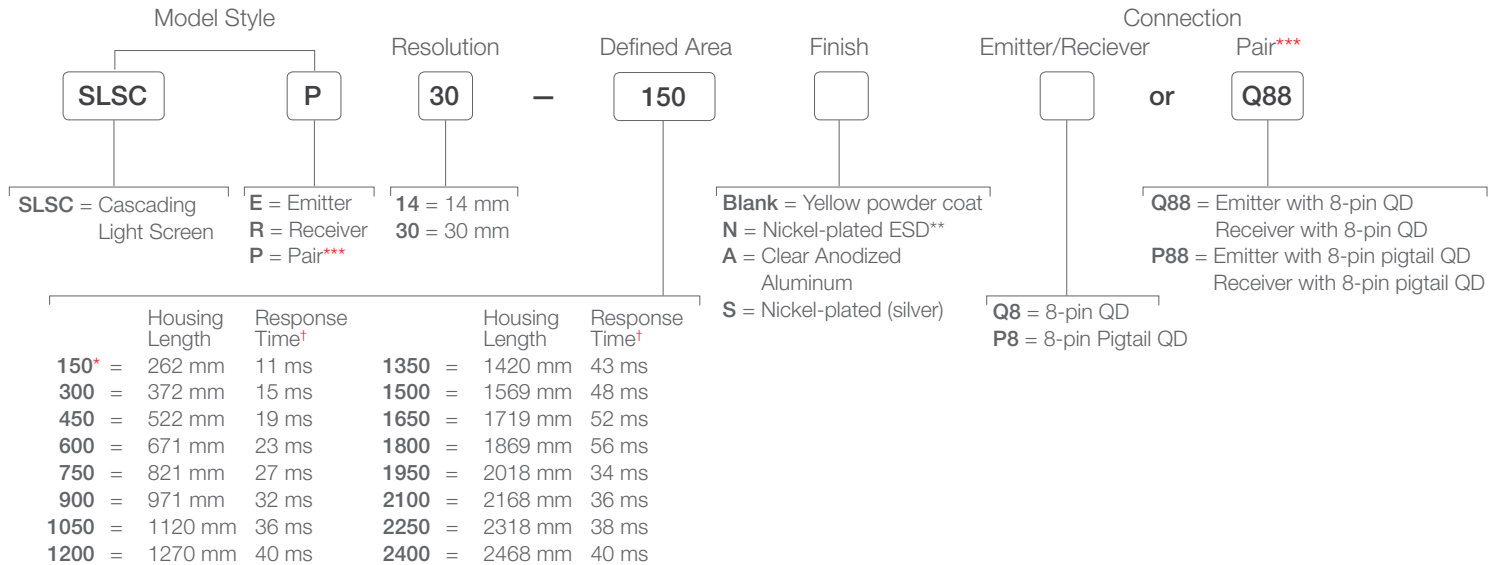

For more specifications see page 559.

**QD models:** A model with a QD requires a mating cordset (see page 578).

For an emitter with TEST function, replace Q8 with Q5 on emitter model numbers (example, SLSE14-150Q5) and Q88 with Q85 on pair model numbers (example, SLSP14-150Q85).

For a 5-pin 300 mm M12/Euro pigtail QD with No EDM or TEST functions, replace Q8 with P5NT on emitter or receiver (example, SLSE14-150P5NT) and Q88 with P55NT on pair model numbers (example, SLSP14-150P55NT).

For a 4-pin 300 mm M12/Euro pigtail QD with no EDM or TEST functions (GND/PE via mounting), replace Q8 with P4NT or Q88 with P44NT (example, SLSP14-150P4NT or SLSP14-150P44NT).

\* 150 mm not available in cascade models  
 \*\* ESD-safe models are not available with the pigtail QD option  
 \*\*\* A pair includes an emitter and receiver (example, SLSP30-150Q88)

† Cascading system response time: To the response time of the slowest pair, add 2 ms for each additional pair.  
 Example: slowest pair's response time is 15 ms, and the system has three additional pairs (four pairs total), so the system maximum response time is 15 ms + 6 ms (3 pairs x 2 ms) = 21 ms.  
 Contact Banner Engineering Corp. for additional information and/or verification of valid kit model numbers.



- 8-Pin**
- QDE-815D**  
4.5 m (15')
  - QDE-825D**  
7.6 m (25')
  - QDE-850D**  
15.3 m (50')
  - QDE-875D**  
22.9 m (75')
  - QDE-8100D**  
30.5 m (100')

**M12/Euro-Style**  
Straight connector  
models listed

NOTE: See page 577 for interfacing solutions.  
Additional accessories are listed on page 686.



**Euro-Style**  
Double-ended  
male/female

- 8-Pin**
- |                                  |                                     |
|----------------------------------|-------------------------------------|
| <b>DEE2R-81D</b><br>0.3 m (1')   | <b>DEE2R-825D</b><br>7.6 m (25')    |
| <b>DEE2R-83D</b><br>0.9 m (3')   | <b>DEE2R-850D</b><br>15.3 m (50')   |
| <b>DEE2R-88D</b><br>2.4 m (8')   | <b>DEE2R-875D</b><br>22.9 m (75')   |
| <b>DEE2R-815D</b><br>4.5 m (15') | <b>DEE2R-8100D</b><br>30.5 m (100') |

**Euro-Style**  
**Adaptor**  
male/female

- |                                  |                                  |
|----------------------------------|----------------------------------|
| <b>8-Pin/4-Pin*</b>              | <b>8-Pin/5-Pin*</b>              |
| <b>DEE8-41D</b><br>0.3 m (1')    | <b>DEE8-51D</b><br>0.3 m (1')    |
| <b>DEE8-48D</b><br>2.4 m (8')    | <b>DEE8-58D</b><br>2.4 m (8')    |
| <b>DEE8-415D</b><br>4.5 m (15')  | <b>DEE8-515D</b><br>4.5 m (15')  |
| <b>DEE8-425DD</b><br>7.6 m (25') | <b>DEE8-525DD</b><br>7.6 m (25') |

\* For SLS/SLP sensors with Q8 or P8 connection to safety BUS gateway/  
node, "smart" self-monitored safety module, safety controller or safety  
PLC see page 771.



**Euro-Style**  
Straight splitter

- 8-Pin**
- CSB-M1280M1280**
  - CSB-M1281M1281**
  - CSB-M1288M1281**
  - CSB-M12815M1281**
  - CSB-M12825M1281**
  - CSB-UNT825M1281**

Additional cordset information is available.  
See page 758



**EZA-MBK-12\*\* EZA-MBK-11\*\* EZA-MBK-20**

Used with: 14 and 30 mm

Additional bracket information is available.  
See page 729



**EZA-MBK-21**

Cascade

**Stands**



see page 802

**Mirrors**

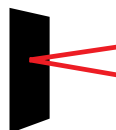

see page 806

**Interface**



see page 820



**Replacement Parts**

Model	Description
<b>EZA-ADE-1</b>	Copolyester access cover with label for 14 or 30 mm resolution emitters
<b>EZA-ADE-2</b>	Copolyester access cover with inverted label for 14 or 30 mm resolution emitters
<b>EZA-ADR-1</b>	Copolyester access cover with label for 14 or 30 mm resolution receiver
<b>EZA-ADR-2</b>	Copolyester access cover with inverted label for 14 or 30 mm resolution receiver
<b>EZA-MBK-12</b>	Center bracket kit (includes 1 bracket and hardware to mount to MSA Series stands) for 14 or 30 mm resolution EZ-SCREEN
<b>EZA-MBK-11</b>	Standard bracket kit with hardware (includes 2 end brackets and hardware to mount to MSA Series stands) for 14 or 30 mm resolution EZ-SCREEN
<b>EZA-TP-1</b>	Access cover security plate (includes 2 screws, wrench) for 14 or 30 mm resolution EZ-SCREEN
<b>EZA-RR-1</b>	External normally open reset switch with 8-pin/M12 Euro-style QD
<b>MGA-K-1</b>	Replacement key for switch MGA-KS0-1
<b>MGA-KS0-1</b>	Panel-mount keyed normally open reset switch
<b>EZA-HK-1</b>	Wrench, Security
<b>EZA-RTP-1</b>	Terminator plug for cascade receiver
<b>STP-13</b>	14 mm test piece (14 mm resolution systems)
<b>STP-14</b>	30 mm test piece (14 mm resolution systems with 2-beam Reduced Resolution and for 30 mm resolution systems)
<b>STP-15</b>	60 mm test piece (30 mm resolution systems with 2-beam Reduced Resolution)

NOTE: See Installation manual p/n 112852 for complete list of replacement parts and accessories.



## EZ-SCREEN® 14 &amp; 30 mm Resolution Specifications

Supply Voltage at the Device	24 V dc $\pm$ 15% (use a SELV-rated supply according to EN IEC 60950) (The external voltage supply must be capable of buffering brief mains interruptions of 20 ms, as specified in EN/IEC 60204-1.)		
Residual Ripple	$\pm$ 10% maximum		
Supply Current	<b>Emitter:</b> 100 mA max., 40 mA at 24 V dc typical <b>Receiver:</b> 275 mA max., 160 mA at 24 V dc typical, exclusive of OSSD1 and OSSD2 loads (up to an additional 0.5A each) and AUX output load (up to 75 mA)		
Response Time	9 to 56 milliseconds (see model number tables) <b>Cascade Safety Stop Interface (CSSI):</b> 40 milliseconds max.		
Remote Test Input (Optional – available only on model SLSE...Q5 emitters)	Test Mode is activated either by applying a low signal (less than 3 V dc) to emitter TEST #1 terminal for a minimum of 50 milliseconds, or by opening a switch connected between TEST #1 and TEST #2 for a minimum of 50 milliseconds. Beam scanning stops to simulate a blocked condition. A high signal at TEST #1 deactivates Test Mode. <b>High signal:</b> 10 to 30 V dc <b>Low signal:</b> 0 to 3 V dc Input current: 35 mA inrush, 10 mA max.		
Wavelength of Emitter Elements	Infrared LEDs, 950 nm at peak emission		
Recovery Time—Blocked to clear (OSSDs turn ON; varies with total number of sensing beams and whether Sync beam is blocked)		<b>Beam 1 (Sync Beam)</b>	<b>All Other Beams</b>
	<b>14 mm Models</b>	109 to 800 ms	33 to 220 ms
	<b>30 mm Models</b>	81 to 495 ms	25 to 152 ms
EDM Input	+24 V dc signals from external device contacts can be monitored (one-channel, two-channel or no monitoring) via EDM1 and EDM2 terminals in the receiver <b>High signal:</b> 10 to 30 V dc at 30 mA typical <b>Low signal:</b> 0 to 3 V dc		
Reset Input	The Reset input must be high for 0.25 to 2 seconds and then low to reset the receiver <b>High signal:</b> 10 to 30 V dc at 30 mA typical <b>Low signal:</b> 0 to 3 V dc Closed switch time: 0.25 to 2 sec		
Safety Outputs (OSSDs)	Two redundant solid-state 24 V dc, 0.5 A max. sourcing OSSD (Output Signal Switching Device) safety outputs. (Use optional interface modules for ac or larger dc loads.) Capable of the Banner "Safety Handshake" <b>ON-State voltage:</b> $\geq$ $V_{in}$ -1.5 V dc <b>OFF-State voltage:</b> 1.2 V dc max. (0-1.2 V dc) <b>Max. load capacitance:</b> 1.0 $\mu$ F <b>Max. load inductance:</b> 10 H <b>Leakage current:</b> 0.50 mA maximum <b>Cable resistance:</b> 10 $\Omega$ maximum <b>OSSD test pulse width:</b> 100 to 300 microseconds <b>OSSD test pulse period:</b> 10 to 27 milliseconds (varies with number of beams) <b>Switching current:</b> 0-0.5 A		
Auxiliary (Aux.) Output Switching Capacity	Current-sourcing (PNP) solid-state output, 24 V dc at 75mA max that follow the safety outputs (lockout function optional)		
Controls and Adjustments	<b>Emitter:</b> <b>Scan Code selection:</b> 2-position switch (code 1 or 2). Factory default position is code 1 <b>Receiver:</b> <b>Scan Code selection:</b> 2-position switch (code 1 or 2). Factory default position is code 1 <b>Trip/Latch Output selection:</b> Redundant switches. Factory default position is T (Trip). <b>EDM/MPCE monitor selection:</b> 2-position switch selects between 1- or 2-channel monitoring. Factory default position is 2 <b>Reduced Resolution (2-beam Floating Blanking):</b> Redundant switches. Factory default is OFF		
Short Circuit Protection	All inputs and outputs are protected from short circuits to +24 V dc or dc common		
Electrical Safety Class (IEC 61140)	III		
Operating Range	<b>14 mm models:</b> 0.1 m to 6 m <b>30 mm models:</b> 0.1 m to 18 m <b>Range decreases with use of mirrors and/or lens shields:</b> Lens shields – approximately 10% less range per shield Glass-surface mirrors – approximately 8% less range per mirror See Accessory section for more information on a specific mirror, page 559.		
Ambient Light Immunity	> 10,000 lux at 5° angle of incidence		
Strobe Light Immunity	Totally immune to one Federal Signal Corp. "Fireball" model FB2PST strobe		
Effective Aperture Angle (EAA)	Meets Type 4 requirements per IEC 61496-2, $\pm$ 2.5° @ 3 m		
Enclosure	<b>Materials:</b> Extruded aluminum housing with yellow polyester powder (optional black or white or nickel-plated silver finish) and well-sealed, rugged die-cast zinc end caps, acrylic lens cover, copolyester access cover. Endcaps on silver models are also nickel-plated. <b>Rating:</b> IP65		
Operating Conditions	<b>Temperature:</b> 0 to +55 °C <b>Relative humidity:</b> 95% (non-condensing)		
Status Indicators	<b>Emitter:</b> One Bi-color (Red/Green) Status Indicator – indicates operating mode, Lockout or power OFF condition 7-segment Diagnostic Indicator (1 digit) – indicates proper operation, scan code or error code <b>Receiver:</b> Yellow Reset Indicator – indicates whether system is ready for operation or requires a reset Bi-Color (Red/Green) Status Indicator – indicates general system and output status Bi-Color (Red/Green) Zone Status Indicators – indicates condition (clear or blocked beam) of a defined group of beams 7-Segment Diagnostic Indicator (3-digit) – indicates proper operation, scan code or error code, total number of blocked beams		
Mounting Hardware	Emitter and receiver each are supplied with a pair of swivel end-mounting brackets. Models longer than 900 mm also include a swivel center-mount bracket. Mounting brackets are 8-gauge cold-rolled steel, black zinc finish.		
Shock and Vibration	EZ-SCREEN® components have passed vibration and shock tests according to IEC 61496-1. This includes vibration (10 cycles) of 10-55 Hz at 0.35 mm single amplitude (0.70 mm peak-to-peak) and shock of 10 g for 16 milliseconds (6,000 cycles).		
Design Standards	Designed to comply with Type 4 per IEC 61496; Category 4 PLe per EN ISO 13849-1; SIL 3 per IEC 61508, SIL CL 3 per IEC 62061; Type 4 per UL 61496-1/-2		
Certifications	 		

# EZ-SCREEN® LS

## Rugged Safety Light Screen with Enhanced Features



- Alignment indicators are highly visible and intuitive diagnostics simplify setup, facilitate troubleshooting and streamline installation
- No blind zone design provides end-to-end sensing to eliminate gaps in detection
- Metal end caps, thick aluminum housing and a recessed window to avoid damage from impact
- Standard pairs, cascade systems and extensive accessories to suit a wide variety of safeguarding configurations
- Cordsets and brackets see page 562

### 1. Choose one

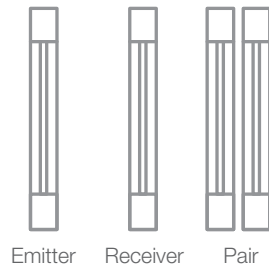

### 2. Choose your resolution

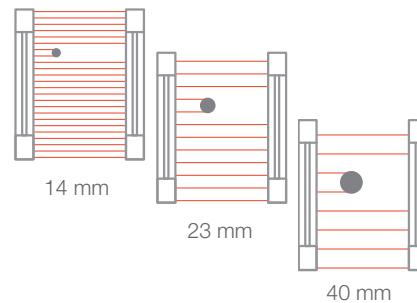

### 3. Choose your defined area

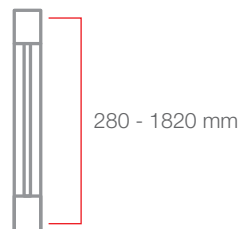

### 4. Choose your machine interface connection

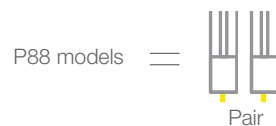
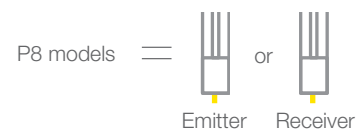

Use DELS-.. cordset for connection between cascade pairs

Build a Standard (Non-Cascade) Pair

- Use standard models for a lower cost safety solution
- Cascade models allow for future flexibility and use of optional indicators (see "Build a Cascade System")

Family	System Type	Resolution	Defined Area		Connector*
<b>SLL</b>	<b>P</b>	<b>14</b>	<b>770</b>		<b>P88</b>
	E = Emitter only R = Receiver only P = Pair (Emitter and Receiver)	14 = 14 mm 23 = 23 mm 40 = 40 mm	280 = 280 mm 350 = 350 mm 420 = 420 mm 490 = 490 mm 560 = 560 mm 630 = 630 mm 700 = 700 mm 770 = 770 mm 840 = 840 mm 910 = 910 mm 980 = 980 mm 1050 = 1050 mm	1120 = 1120 mm 1190 = 1190 mm 1260 = 1260 mm 1330 = 1330 mm 1400 = 1400 mm 1470 = 1470 mm 1540 = 1540 mm 1610 = 1610 mm 1680 = 1680 mm 1750 = 1750 mm 1820 = 1820 mm	P8 = 300 mm pigtail, 8-Pin M12 QD (individual Emitter or Receiver models) P88 = 300 mm pigtail, 8-Pin M12 QD (on BOTH Emitter and Receiver models) Blank = no pigtail, RD connection (for RDLS-8..D cordset)

\* 5-pin M12 QD options available (P5 or P55)

Build a Cascade System

- Determine the configuration of the first EZ-SCREEN® LS pair ("master" connected to the machine control)
- Determine the remaining (second, third or fourth) pairs ("slaves" connected to the master using a DELS-.. cordset)

Family	Cascadable	System Type	Resolution	Defined Area		Connector*
<b>SLL</b>	<b>C</b>	<b>P</b>	<b>14</b>	<b>770</b>		<b>P88</b>
	C = Cascadable	E = Emitter only R = Receiver only P = Pair (Emitter and Receiver)	14 = 14 mm 23 = 23 mm 40 = 40 mm	350 = 350 mm 420 = 420 mm 490 = 490 mm 560 = 560 mm 630 = 630 mm 700 = 700 mm 770 = 770 mm 840 = 840 mm 910 = 910 mm 980 = 980 mm 1050 = 1050 mm	1120 = 1120 mm 1190 = 1190 mm 1260 = 1260 mm 1330 = 1330 mm 1400 = 1400 mm 1470 = 1470 mm 1540 = 1540 mm 1610 = 1610 mm 1680 = 1680 mm 1750 = 1750 mm 1820 = 1820 mm	P8 = 300 mm pigtail, 8-Pin M12 QD (individual Emitter or Receiver models) P88 = 300 mm pigtail, 8-Pin M12 QD (on BOTH Emitter and Receiver models) Blank = no pigtail, RD connection (for RDLS-8..D cordset)

\* 5-pin M12 QD options available (P5 or P55)

For more specifications see page 563.

QD models: A model with a QD requires a mating cordset (see page 578).

## Machine Interface Connections



8-Pin

RD Cordsets

**RDLS-815**  
4.6 m (15')  
**RDLS-825**  
8 m (26')  
**RDLS-860**  
15 m (60')

NOTE: 5-pin options available



8-Pin

**M12/Euro-Style**  
Straight connector  
models listed

**QDE-815D**  
4.5 m (15')  
**QDE-825D**  
7.6 m (25')  
**QDE-850D**  
15.3 m (50')  
**QDE-875D**  
22.9 m (75')  
**QDE-8100D**  
30.5 m (100')



**Euro-Style**  
Straight splitter

8-Pin

**CSB-M1280M1280**  
**CSB-M1281M1281**  
**CSB-M1288M1281**  
**CSB-M12815M1281**  
**CSB-M12825M1281**



**Euro-Style**  
Double-ended  
male/female

8-Pin\*

**DEE2R-81D**  
0.3 m (1')  
**DEE2R-83D**  
0.9 m (3')  
**DEE2R-88D**  
2.4 m (8')  
**DEE2R-815D**  
4.5 m (15')

**DEE2R-825D**  
7.6 m (25')  
**DEE2R-850D**  
15.3 m (50')  
**DEE2R-875D**  
22.9 m (75')  
**DEE2R-8100D**  
30.5 m (100')

## Cascading Connections



Double-ended  
RD to RD

**DELS-110E**  
0.05 m (0.2')  
**DELS-111E**  
0.3 m (1')  
**DELS-113E**  
1 m (3.3')  
**DELS-118E**  
2.5 m (8.2')

**DELS-1115E**  
4.6 m (15')  
**DELS-1125E**  
8 m (26')  
**DELS-1150E**  
15.3 m (50')

Additional cordset information is available.  
See page 758



EZLSA-MBK-11



EZLSA-MBK-12



EZLSA-MBK-16



EZLSA-MBK-20

Additional bracket information is available.  
See page 729



**EZLSA-K30LGR**  
Connects directly to **SLLCR...**  
cascade receiver



**K30LGRXPQ**  
requires 4-pin QD



**K50LGRXPQ**  
requires 4-pin QD



**TL50GRQ**  
requires 4-pin QD



**RD to Euro-Style\***  
Connects indicators  
to a cascade receiver

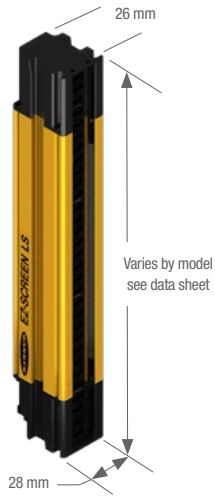

**DELSEF-40D**  
0.5 m (0.02')  
**DELSEF-41D**  
0.3 m (1')  
**DELSEF-43D**  
1 m (3.3')  
**DELSEF-48D**  
2.5 m (8.2')  
**DELSEF-415D**  
4.6 m (15.1')

NOTE: For Remote Fixed Blanking use **DELSEF-81D**



EZ-SCREEN LS Systems

### EZ-SCREEN LS Specifications

Supply Voltage at the Device	24 V dc $\pm 15\%$ (use a SELV-rated power supply according to EN IEC 60950). The external voltage supply must be capable of buffering brief mains interruptions of 20 ms, as specified in IEC/EN 60204-1.
Short Circuit Protection	All inputs and outputs are protected from short circuits to +24 V dc or dc common
Supply Protection Circuitry	
Output Configuration	<b>Off-state leakage current:</b> less than 10 $\mu$ A <b>PNP On-state saturation voltage:</b> less than 200 mV at 10 mA load and less than 1.0 V at 100 mA <b>NPN On-state saturation voltage:</b> less than 1.0 V at 10 mA load and less than 2.0 V at 100 mA
Effective Aperture Angle (EAA)	Meets Type 4 requirements per IEC 61496-2
Residual Ripple	$\pm 10\%$ maximum
Electrical Safety Class	III (per IEC 61140: 1997)
Operating Range	0.1 m to 12 m (4 in to 39 ft) — Range decreases with use of mirrors and/or lens shields: <ul style="list-style-type: none"> <li>• Lens shields — approx 10% less range per shield</li> <li>• Glass-surface mirrors — approx 8% less range per mirror</li> </ul> See the specific mirror datasheet for more information
Mounting Hardware	Emitter and receiver each are supplied with a pair of swivel end-mounting brackets ( <b>EZLSA-MBK-11</b> ). Models 980 mm and longer are supplied with an additional center-mount bracket ( <b>EZLSA-MBK-12</b> ) for center support in applications with significant vibration. Mounting brackets are 8-gauge cold-rolled steel, black zinc finish.
Resolution	14 mm, 23 mm, or 40 mm, depending on model
Enclosure	Extruded aluminum housing with yellow polyester powder finish standard and well-sealed, rugged die-cast zinc end caps, acrylic lens cover
Safety Rating	Type 4 per IEC 61496-1, -2 Category 4 PL e per EN ISO13849-1 SIL3 per IEC 61508; SIL CL3 per IEC 62061
Environmental Rating	IEC IP65/IEC IP67
Shock and Vibration	Components have passed vibration and shock tests according to IEC 61496-1. This includes vibration (10 cycles) of 10-55 Hz at 0.35 mm (0.014 in) single amplitude (0.70 mm peak-to-peak) and shock of 10 g for 16 milliseconds (6,000 cycles).
Operating Conditions	-20 to +55 °C (-4 to +131 °F) 95% maximum relative humidity (non-condensing)
Certifications	 

# EZ-SCREEN® Low Profile (LP)

## Type 4 Safety Light Screens



- Small, compact design with end-to-end sensing.
- Operating range up to 7 m
- Features seven-segment display for diagnostic information and number of blocked beams
- Offers reduced resolution and fixed blanking to ignore tooling or constant inflow of materials
- Identifies clear and blocked beams using zone indicators
- Exceeds OSHA/ANSI Control Reliability requirements, certified to cTUVus, and CE certified to Type 4, Cat 4 PLe, and SIL 3
- Cordsets and brackets see page 568

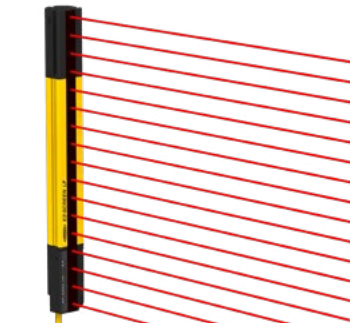

### 14 mm Resolution

14 mm resolution safety light screens can be used for finger, hand and ankle protection.

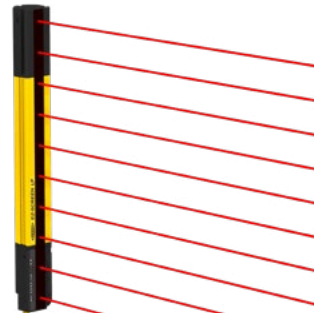

### 25 mm Resolution

25 mm resolution safety light screens can be used for hand and ankle protection.



### Cascade

Low-profile models allow four systems of any length and resolution to be connected in a series, forming a single safety device.



Yellow Painted  
Aluminum

Clear Anodized  
Aluminum

Nickel-Plated  
ESD

EZ-SCREEN® Low-Profile Systems, Non-Cascade

Example Model Number SLPP14-270Q88

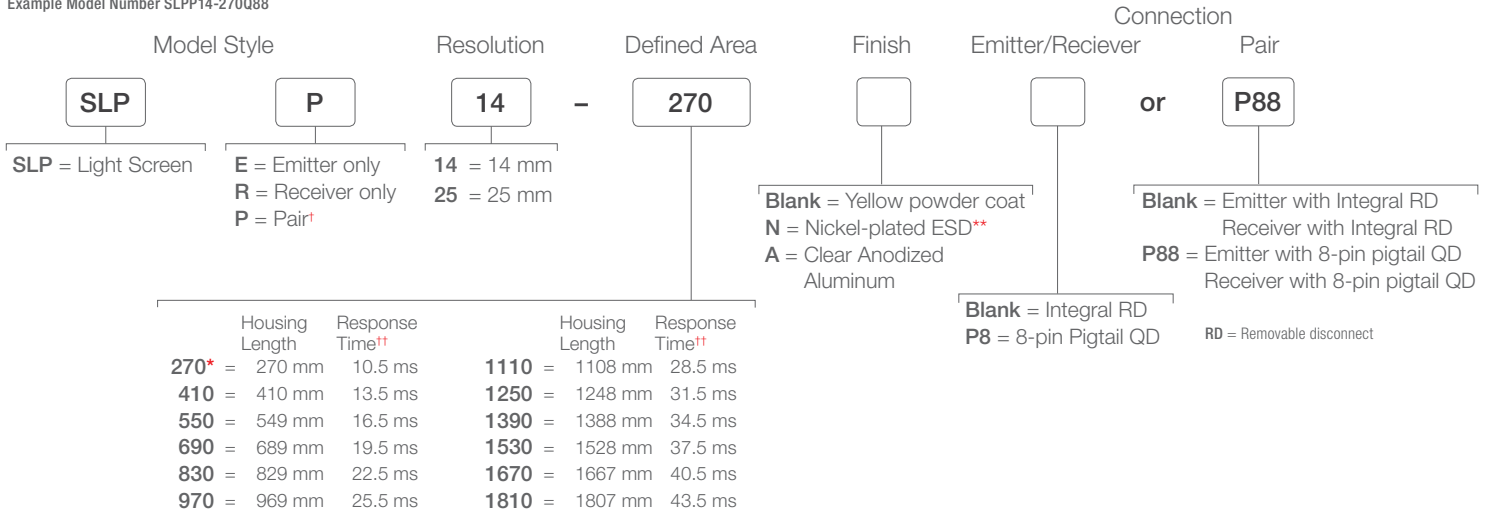

EZ-SCREEN® Low-Profile Systems, Cascadable

Example Model Number SLPCP25-270Q88

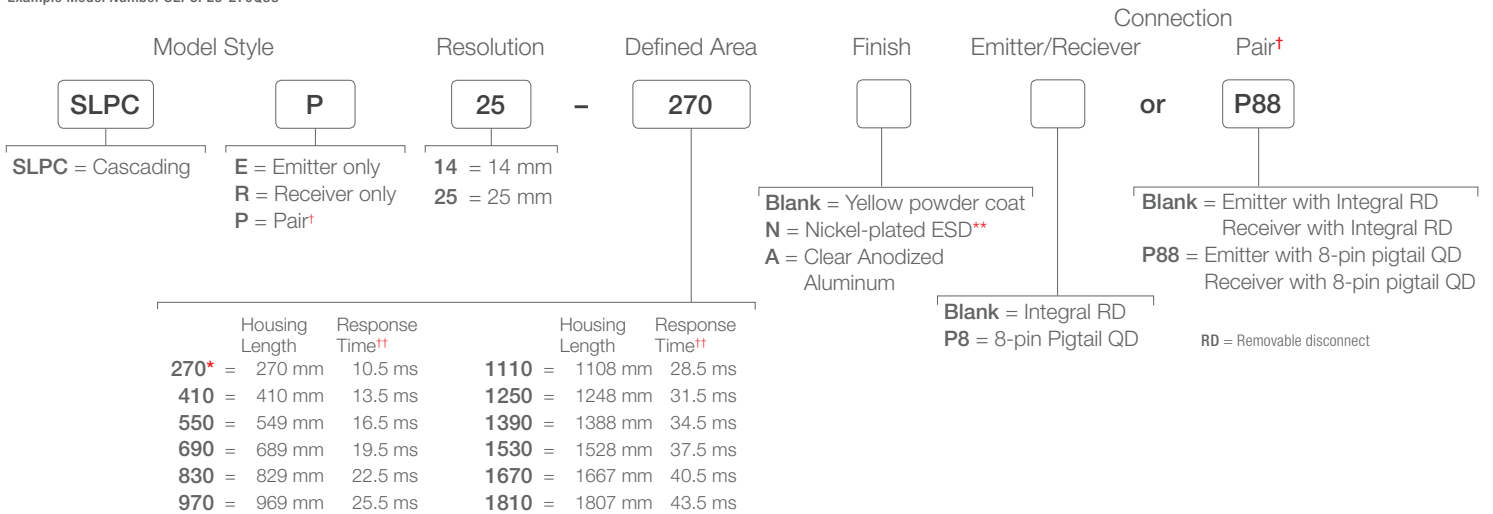

For more specifications see page 570.

 QD models: A model with a QD requires a mating cordset (see page 570).

QD models: Pigtail QD models require mating cordsets with an 8-pin M12/Euro-style connector (such as QDE-8..D, DEE2R-8..D or CSB-M128..M1261; see page 568).  
 Integral RD models require mating cordsets with a removable disconnect connector (such as RDLP-8..D or DELPE-8..D; see page 568).

\* 270 mm not available in cascade models  
 \*\* ESD-safe models are not available with the pigtail QD option  
 † A pair includes an emitter and receiver (example, SLSP30-150Q88)  
 †† Cascading system response time: To the response time of the slowest pair, add 2 ms for each additional pair.  
 Example: slowest pair's response time is 15 ms, and the system has three additional pairs (four pairs total), so the system maximum response time is 15 ms + 6 ms (3 pairs x 2 ms) = 21 ms.

Contact Banner Engineering Corp. for additional information and/or verification of valid kit model numbers.

# EZ-SCREEN® Low Profile (LP)

## With Muting—Type 4 Safety Light Screens



- Has a built-in muting function with no third box required.
- Eight pre-defined muting configuration options including Bypass, Mute-Dependent Override, Mute Enable, and Mute-cycle time extensions (four seconds) for “L”-style cell exit applications
- Mute Lamp and Status Outputs to EZ-LIGHT (or other indicating devices)
- Lower power consumption allows for energy savings and fewer/smaller power supplies
- Exceeds OSHA/ANSI Control Reliability requirements, certified to cTUVus, and CE certified to Type 4, Cat 4 PLe, and SIL 3
- Cordsets and brackets see page 568

### EZ-SCREEN® Low-Profile with Muting Systems, 25 mm Resolution

Example Model Number SLPMP14-410Q128

Model Style	Resolution	Defined Area	Finish	Emitter/Receiver	Connection Pair*																																				
<b>SLPMP</b>	<b>14</b>	<b>410</b>			<b>or</b> <b>P128</b>																																				
SLPE = Emitter SLPR = Receiver SLPMP = Muting LP Pair*	14 = 14 mm 25 = 25 mm	<table border="1"> <thead> <tr> <th></th> <th>Housing Length</th> <th>Response Time††</th> </tr> </thead> <tbody> <tr><td>410</td><td>410 mm</td><td>13.5 ms</td></tr> <tr><td>550</td><td>549 mm</td><td>16.5 ms</td></tr> <tr><td>690</td><td>689 mm</td><td>19.5 ms</td></tr> <tr><td>830</td><td>829 mm</td><td>22.5 ms</td></tr> <tr><td>970</td><td>969 mm</td><td>25.5 ms</td></tr> <tr><td>1110</td><td>1108 mm</td><td>28.5 ms</td></tr> <tr><td>1250</td><td>1248 mm</td><td>31.5 ms</td></tr> <tr><td>1390</td><td>1388 mm</td><td>34.5 ms</td></tr> <tr><td>1530</td><td>1528 mm</td><td>37.5 ms</td></tr> <tr><td>1670</td><td>1667 mm</td><td>40.5 ms</td></tr> <tr><td>1810</td><td>1807 mm</td><td>43.5 ms</td></tr> </tbody> </table>		Housing Length	Response Time††	410	410 mm	13.5 ms	550	549 mm	16.5 ms	690	689 mm	19.5 ms	830	829 mm	22.5 ms	970	969 mm	25.5 ms	1110	1108 mm	28.5 ms	1250	1248 mm	31.5 ms	1390	1388 mm	34.5 ms	1530	1528 mm	37.5 ms	1670	1667 mm	40.5 ms	1810	1807 mm	43.5 ms	Blank = Yellow powder coat N = Nickel-plated ESD A = Clear Anodized Aluminum	Blank = Integral RD P8 = 8-pin Pigtail QD (SLP Emitter) P12 = 12-pin Pigtail QD (SLPM Receiver)	Blank = Receiver with Integral RD Emitter with Integral RD P128 = Emitter with 8-pin pigtail QD Receiver with 12-pin pigtail QD (SLPM Receiver)
	Housing Length	Response Time††																																							
410	410 mm	13.5 ms																																							
550	549 mm	16.5 ms																																							
690	689 mm	19.5 ms																																							
830	829 mm	22.5 ms																																							
970	969 mm	25.5 ms																																							
1110	1108 mm	28.5 ms																																							
1250	1248 mm	31.5 ms																																							
1390	1388 mm	34.5 ms																																							
1530	1528 mm	37.5 ms																																							
1670	1667 mm	40.5 ms																																							
1810	1807 mm	43.5 ms																																							
					RD = Removable disconnect																																				

For more specifications see page 570.

QD models: A model with a QD requires a mating cordset (see page 568).

QD models: Pigtail QD models require mating cordsets with an 8 or 12-pin M12/Euro-style connector (such as QDE-8..D, QDE-12..E, DEE2R-8..D). Integral RD models require mating cordsets with a removable disconnect connector (such as RDLP-8..D or RDLP-11..E).

\* A pair includes an emitter and receiver (example, SLPMP14-410P128)

Contact Banner Engineering Corp. for additional information and/or verification of valid model numbers.



EZ-SCREEN® LPM Cordset Overview\*

Muting Splitter Cordsets

3-Branch models	Banner sensors (PNP)
CSM3DO-M12121FM12121M	Dark Operate (pin 2)
CSM3LO-M12121FM12121M	Light Operate (pin 4)
4-Branch models (With Emitter hookup)	
CSM4DO-M12121FM12121M	Dark Operate (pin 2)
CSM4LO-M12121FM12121M	Light Operate (pin 4)
Muting Sensor Cordsets (C & D)	Length
DEE2R-51D	0.3 m (1')
DEE2R-53D	1 m (3')
DEE2R-58D	2.5 m (8')
DEE2R-815D	4.5 m (15')

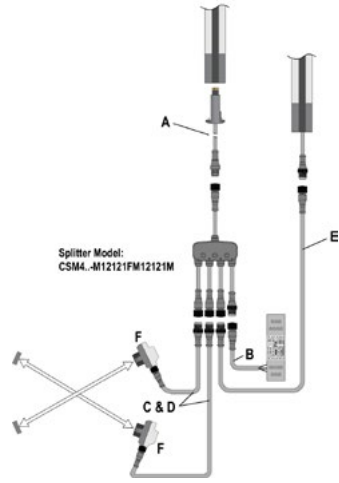

\* "A" (Receiver cordset): On RD models = DELPE-12xxE; On P12 models cordset "A" is a preinstalled DELPE-121E.

"B": Machine interface cordset = QDE-12xxE.

"C" and "D": Muting Sensor cordsets = DEE2R-515D. Ensure sensors connected to Cordsets C & D are PNP output with Dark Operate on pin 2 or Light Operate on pin 4.

"E" (Emitter cordset): On RD models = DELPE-12xxE; On P8 models (shown), use a DEE2R-8xxD double-ended cordset. If using a 3-Branch Muting Splitter cordset, use appropriate Emitter cordset.

"F": QS18VP6LPQ8 (4-pin M12/Euro QD) sensor shown as example. Other sensors or switches may be used.

\* NOTE: See EZ-SCREEN® Low Profile with Muting manual (p/n 150216) for complete information.

EZ-SCREEN® Muting Indicators

TL50WQ	Single Color (White)
DELPEF-40D	Single Color Cordset 0.05 m
DELPEF-41D	Single Color Cordset 0.3 m
DELPEF-43D	Single Color Cordset 1 m
K50LGRW2PQ-18886	Three Color (Green/Red/White)
TL50GYRWQ	Four Color (Green/Yellow/Red/White)
DELPEF-50D	Multi-Color Cordset 0.05 m
DELPEF-51D	Multi-Color Cordset 0.3 m
DELPEF-53D	Multi-Color Cordset 1 m
LPA-MBK-15	Optional mounting bracket (Used with DELPEF-..0D cordset)

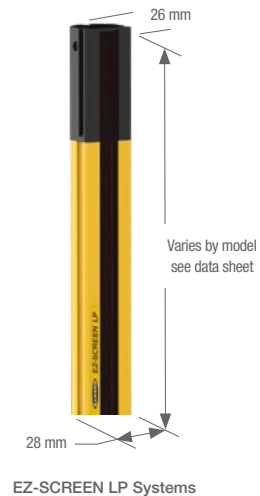

Additional Indicators available, see EZS LPM manual

# SAFETY

# LIGHT SCREENS

# CONTROLLERS

# EMERGENCY STOP & STOP CONTROL



RD Cordsets

### 8-Wire\*

<b>RDLP-815D</b>
4.5 m (15')
<b>RDLP-825D</b>
7.6 m (25')
<b>RDLP-850D</b>
15.3 m (50')
<b>RDLP-875D</b>
22.9 m (75')
<b>RDLP-8100D</b>
30.5 m (100')

### 11-Wire

<b>RDLP-1115E</b>
4.5 m (15')
<b>RDLP-1125E</b>
7.6 m (25')
<b>RDLP-1150E</b>
15.3 m (50')
<b>RDLP-1175E</b>
22.9 m (75')
<b>RDLP-11100E</b>
30.5 m (100')



RD to Euro QD\*\*

### 8-Pin Male

<b>DELPE-81D</b>
0.3 m (1')
<b>DELPE-83D</b>
0.9 m (3')
<b>DELPE-88D</b>
2.4 m (8')
<b>DELPE-815D</b>
4.5 m (15')
<b>DELPE-825D</b>
7.6 m (25')
<b>DELPE-850D</b>
15.3 m (50')
<b>DELPE-875D</b>
22.9 m (75')
<b>DELPE-8100D</b>
30.5 m (100')

### 12-Pin Male

<b>DELPE-81E</b>
0.3 m (1')
<b>DELPE-83E</b>
0.9 m (3')
<b>DELPE-88E</b>
2.4 m (8')
<b>DELPE-815E</b>
4.5 m (15')
<b>DELPE-825E</b>
7.6 m (25')
<b>DELPE-850E</b>
15.3 m (50')
<b>DELPE-875E</b>
22.9 m (75')
<b>DELPE-8100E</b>
30.5 m (100')

### 8-Pin Female

<b>DELPEF-81E</b>
0.3 m (1')
<b>DELPEF-83E</b>
0.9 m (3')
<b>DELPEF-88E</b>
2.4 m (8')
<b>DELPEF-815E</b>
4.5 m (15')



RD to RD

<b>DELPE-110E</b>
0.05 m (0.2')
<b>DELPE-110E</b>
0.3 m (1')
<b>DELPE-110E</b>
1 m (3.3')
<b>DELPE-118E</b>
2.5 m (8.2')
<b>DELS-1115E</b>
4.6 m (15')
<b>DELS-1125E</b>
8 m (26')
<b>DELS-1150E</b>
15.3 m (50')
<b>DELS-1175E</b>
23 m (75')
<b>DELS-11100E</b>
30 m (100')

**Use with:** models with integral RD connections. All standard cordsets are yellow PVC with black overmold. For black PVC cable and overmold, add suffix **B** to model number (example, **RDLP-815DB**).

\* For connection of E-Stop or other hard/relay contacts see page 774.

\*\* Requires mating 8-pin M12/Euro cordset. 8-pin Male used for Machine Interface connection (indicator end of sensor). 8-pin Female used for cascade connection when using M12/Euro QDs. See page 567 for EZ-SCREEN® LPM cordset overview.



Euro-Style Double-ended male/female

### 8-Pin\*

<b>DEE2R-81D</b>	<b>DEE2R-825D</b>
0.3 m (1')	7.6 m (25')
<b>DEE2R-83D</b>	<b>DEE2R-850D</b>
0.9 m (3')	15.3 m (50')
<b>DEE2R-88D</b>	<b>DEE2R-875D</b>
2.4 m (8')	22.9 m (75')
<b>DEE2R-815D</b>	<b>DEE2R-8100D</b>
4.5 m (15')	30.5 m (100')



M12/Euro-Style Straight connector models listed

### 8-Pin

<b>QDE-815D</b>
4.5 m (15')
<b>QDE-825D</b>
7.6 m (25')
<b>QDE-850D</b>
15.3 m (50')
<b>QDE-875D</b>
22.9 m (75')
<b>QDE-8100D</b>
30.5 m (100')



Euro-Style Straight splitter

### 8-Pin

<b>CSB-M1280M1280</b>
<b>CSB-M1281M1281</b>
<b>CSB-M1288M1281</b>
<b>CSB-M12815M1281</b>
<b>CSB-M12825M1281</b>

**Use with:** models with Pigtail QD and DELPE-8xxD connections.

\* For connection to safety BUS gateway/node, a "smart" self-monitored safety module, safety controller or safety PLC see page 771.

Additional cordset information is available. See page 758



LPA-MBK-11\*



LPA-MBK-12\*



LPA-MBK-20



LPA-MBK-22



LPA-MBK-21



LPA-MBK-90



LPA-MBK-120



LPA-MBK-135

\* Standard brackets included with emitter/receiver.

**Use with:** Low-Profile 14 & 25 mm

**Use with:** Low-Profile 14 & 25 mm-Cascade

Additional bracket information is available. See page 729

Stands



Mirrors



Interface



Additional interfacing and accessory information is available. See page 802

Remote Fixed Blanking Switch



Allows frequent configuration of a fixed blanked area, without using the receiver DIP switches.

EZA-RBK-1

Replacement Parts

Model	Description
STP-13	14 mm test piece (for 14 mm resolution systems)
STP-16	25 mm test piece (for 25 mm resolution systems)
STP-17	34 mm test piece (for 14 mm resolution systems with 2-beam reduced resolution enabled)
STP-18	65 mm test piece (for 25 mm resolution systems with 2-beam reduced resolution enabled)
LPA-TP-1	Terminator plug, for SLPC... emitter/receiver (included with sensor)
EZA-RR-1	External normally open reset switch with 8-pin M12/Euro-style QD
MGA-KSO-1	Panel-mount keyed normally open reset switch









Model	Description
MGA-K-1	Replacement key for switch MGA-KSO-1
DELPE-81D	Replacement for M12-terminated pigtail QD, as shipped with standard pigtail QD models; 8-conductor cable, 22 AWG; 0.3 m long
LPA-MBK-11	End-cap bracket kit (includes 2 end brackets and hardware to mount one sensor to MSA series stands; 360° sensor rotation; 14 ga (1.9 mm) steel, black zinc plated; die-cast zinc end-cap plate
LPA-MBK-12	Side-mount bracket kit (includes 1 bracket and hardware to mount to MSA Series stands; +10°/ -30° sensor rotation; 14 ga (1.9 mm) steel, black zinc plated; die-cast zinc clamp

NOTE: See installation manual p/n 112852 for complete list of replacement parts and accessories.

## EZ-SCREEN® Low-Profile 14 &amp; 25 mm Resolution Specifications

Supply Voltage at the Device	24 V dc $\pm$ 15% (use a SELV-rated supply according to EN IEC 60950) (The external voltage supply must be capable of buffering brief mains interruptions of 20 milliseconds, as specified in EN IEC 60204-1.)										
Residual Ripple	$\pm$ 10% maximum										
Supply Current	<b>Emitter:</b> 60 mA max., exclusive of fault load <b>Receiver:</b> 150 mA max., exclusive of OSSD1 and OSSD2 loads (up to an additional 0.5A each) and Aux Output load (up to an additional 0.25A)										
Response Time	8 to 43.5 milliseconds (see model number tables) <b>Cascade safety stop interface (CSSI):</b> 40 milliseconds max. (contacts must be open for 60 milliseconds min.)										
Remote Test Input	Test mode is activated either by applying a low signal (less than 3 V dc) to emitter Test/Reset terminal for a minimum of 50 milliseconds, or by opening a switch connected between Test/Reset and 24 V dc for a minimum of 50 milliseconds. Beam scanning stops to simulate a blocked condition. A high signal at Test/Reset deactivates Test Mode. <b>High Signal:</b> 10 to 30 V dc <b>Low Signal:</b> 0 to 3 V dc <b>Input Current:</b> 35 mA inrush, 10 mA max.										
Wavelength of Emitter Elements	Infrared LEDs, 850 nm at peak emission										
Recovery Time—Blocked to clear (OSSDs turn ON; varies with total number of sensing beams and whether Sync beam is blocked)	<table border="1"> <thead> <tr> <th></th> <th>Beam 1 (Sync Beam)</th> <th>All Other Beams</th> </tr> </thead> <tbody> <tr> <td>14 mm Models</td> <td>109 to 800 ms</td> <td>33 to 220 ms</td> </tr> <tr> <td>30 mm Models</td> <td>81 to 495 ms</td> <td>25 to 152 ms</td> </tr> </tbody> </table>			Beam 1 (Sync Beam)	All Other Beams	14 mm Models	109 to 800 ms	33 to 220 ms	30 mm Models	81 to 495 ms	25 to 152 ms
	Beam 1 (Sync Beam)	All Other Beams									
14 mm Models	109 to 800 ms	33 to 220 ms									
30 mm Models	81 to 495 ms	25 to 152 ms									
EDM Input	+24 V dc signals from external device contacts can be monitored (one-channel, two-channel or no monitoring) via EDM1 and EDM2 terminals in the receiver <b>High Signal:</b> 10 to 30 V dc at 30 mA typical <b>Low Signal:</b> 0 to 3 V dc										
Reset Input	The Reset input must be high for 0.25 to 2 seconds and then low to reset the receiver <b>High Signal:</b> 10 to 30 V dc at 30 mA typical <b>Low Signal:</b> 0 to 3 V dc <b>Closed Switch Time:</b> 0.25 to 2 seconds										
Safety Outputs (OSSDs)	Two redundant solid-state 24 V dc, 0.5 A max. sourcing OSSD (Output Signal Switching Device) safety outputs. (Use optional interface modules for ac or larger dc loads.) Capable of the Banner "Safety Handshake" <b>ON-State voltage:</b> $\geq$ $V_{in}$ -1.5 V dc <b>OFF-State voltage:</b> 1.2 V dc max. (0-1.2 V dc) <b>Max. load capacitance:</b> 1.0 $\mu$ F <b>Max. load inductance:</b> 10 H <b>Leakage Current:</b> 0.50 mA maximum <b>Cable Resistance:</b> 10 $\Omega$ maximum <b>OSSD test pulse width:</b> 100 to 300 microseconds <b>OSSD test pulse period:</b> 10 to 22 milliseconds (varies with number of beams) <b>Switching Current:</b> 0-0.5 A										
Auxiliary (Aux.)/Fault Output Switching Capacity	Current-sourcing (PNP) Solid-state output, 24 V dc at 250 mA max. that follow safety outputs or lock out status (configurable)										
External Remote Indicator Outputs (SLPMR models only)	Current sourcing (PNP), solid-state, 24 V dc outputs for the connection of remote indicator lamps such as EZ-LIGHTs. See EZ-LIGHT™ for EZ-SCREEN® Low Profile with Muting in manual <b>150216</b> for compatible EZ-LIGHTs and associated cordsets. <b>Rated Current:</b> 100 mA maximum at 24 V dc										
Controls and Adjustments	<b>Emitter:</b> <b>Scan Code selection:</b> 2-position switch (code 1 or 2). Factory default position is code 1. <b>Test/Reset:</b> 2-position switch. Factory default position is Reset. <b>Invert Display:</b> 2-position switch. Factory default position is OFF (Standard display). <b>Fault:</b> 2-position switch. Factory default position is OFF.  <b>Receiver:</b> <b>Scan Code selection:</b> 2-position switch (code 1 or 2). Factory default position is code 1. <b>Trip/Latch Output selection:</b> Redundant switches. Factory default position is T (trip). <b>EDM/MPCE monitor selection:</b> 2-position switch selects between 1- or 2-channel monitoring. Factory default position is 2-channel monitoring. (SLPMR models: 1-channel monitoring only) <b>Mute Lamp Monitoring:</b> ON/OFF switch. Factory default position is ON (SLPMR models only) <b>Reduced Resolution:</b> Redundant switches. Factory default position is OFF. <b>Aux/Fault:</b> 2-position switch. Factory default position is Aux. <b>Invert Display:</b> 2-position switch. Factory default position is OFF.										
Short Circuit Protection	All inputs and outputs are protected from short circuits to +24 V dc or dc common										
Electrical Safety Class (IEC 61140)	III										

EZ-SCREEN® Low-Profile 14 & 25 mm Resolution Specifications (cont'd)

<p><b>Operating Range</b></p>	<p>0.1 to 7 m                  Range decreases with use of mirrors and/or lens shields:                  Lens shields – approximately 10% less range per shield                  Glass-surface mirrors – approximately 8% less range per mirror                  See the Accessory section for more information on a specific mirror page 806, for further information.</p>			
<p><b>Ambient Light Immunity</b></p>	<p>&gt; 10,000 lux at 5° angle of incidence</p>			
<p><b>Strobe Light immunity</b></p>	<p>Totally immune to one Federal Signal Corp. "Fireball" model FB2PST strobe</p>			
<p><b>Effective Aperture Angle (EAA)</b></p>	<p>Meets Type 4 requirements per IEC 61496-2, ± 2.5° @ 3 m</p>			
<p><b>Enclosure</b></p>	<p><b>Materials:</b> Extruded aluminum housing with yellow polyester powder finish standard (optional clear anodized aluminum or nickel-plated silver finish) and well-sealed, rugged die-cast zinc end caps, acrylic lens cover, copolyester access cover. End caps on silver models are also nickel-plated. ESD-safe models have static-dissipative acrylic lens cover.  <b>Rating:</b> IP65</p>			
<p><b>Operating Conditions</b></p>	<p><b>Temperature:</b> 0 to +55 °C  <b>Max. Relative Humidity:</b> 95% maximum relative humidity (non-condensing)</p>			
<p><b>Status Indicators</b></p>	<p><b>Emitter:</b>                  One Bicolor (Red/Green) status indicator – indicates operating mode, lockout or power OFF condition                  7-segment Diagnostic Indicator (1 digit) – indicates proper operation, scan code or error code</p> <p><b>Receiver:</b>                  Yellow Reset indicator – indicates whether system is ready for operation or requires a reset                  Bicolor (Red/Green) Status indicator – indicates general system and output status                  Bicolor (Red/Green) Zone Status indicators – indicate condition (clear or blocked beam) of a defined group of beams                  7-Segment Diagnostic indicator (1 digit) – indicates proper operation, scan code, or error code, total number of blocked beams                  Yellow Mute Device Input Indicators – indicates status of mute device inputs (SLPMR models only)</p>			
<p><b>Mounting Hardware</b></p>	<p>Emitter and receiver each are supplied with a pair of swivel end-mounting brackets and two swivel side-mounting brackets. Models longer than 690 mm also include one or more additional side-mount brackets for center support.</p>			
<p><b>Shock and Vibration</b></p>	<p>EZ-SCREEN® LP components have passed vibration and shock tests according to IEC 61496-1. This includes vibration (10 cycles) of 10-55 Hz at 0.35 mm single amplitude (0.70 mm peak-to-peak) and shock of 10 g for 16 milliseconds (6,000 cycles).</p>			
<p><b>Design Standards</b></p>	<p>Designed to comply with Type 4 per IEC 61496-1/-2; Category 4 PLe per EN ISO 13849-1; SIL 3 per IEC 61508, SIL CL3 per IEC 62061</p>			
<p><b>Certifications</b></p>	<table border="0"> <tr> <td data-bbox="397 1087 500 1213" rowspan="2">  </td> <td data-bbox="506 1087 1552 1213">  <p>TUV Rheinland of North America, a Nationally Recognized Test Laboratory (NRTL) in the United States according to OSHA 29 CFR 1910.7, and accredited by the Standards Council of Canada to test and certify products to Canadian National Standards, has certified the EZ-SCREEN® Low Profile to all applicable U.S. and Canadian National Standards. The cTUVus mark is recognized throughout the United States and Canada by OSHA and the SCC.</p> </td> </tr> <tr> <td data-bbox="506 1222 1552 1323">  <p>Actual certification mark on EZ-SCREEN® Low Profile product labels.                  This simplified certification mark is used on the product labels due to limited space.</p> </td> </tr> </table>		 <p>TUV Rheinland of North America, a Nationally Recognized Test Laboratory (NRTL) in the United States according to OSHA 29 CFR 1910.7, and accredited by the Standards Council of Canada to test and certify products to Canadian National Standards, has certified the EZ-SCREEN® Low Profile to all applicable U.S. and Canadian National Standards. The cTUVus mark is recognized throughout the United States and Canada by OSHA and the SCC.</p>	 <p>Actual certification mark on EZ-SCREEN® Low Profile product labels.                  This simplified certification mark is used on the product labels due to limited space.</p>
	 <p>TUV Rheinland of North America, a Nationally Recognized Test Laboratory (NRTL) in the United States according to OSHA 29 CFR 1910.7, and accredited by the Standards Council of Canada to test and certify products to Canadian National Standards, has certified the EZ-SCREEN® Low Profile to all applicable U.S. and Canadian National Standards. The cTUVus mark is recognized throughout the United States and Canada by OSHA and the SCC.</p>			
	 <p>Actual certification mark on EZ-SCREEN® Low Profile product labels.                  This simplified certification mark is used on the product labels due to limited space.</p>			

# EZ-SCREEN® Grids

## Type 4 Multi-Beam Systems



- The EZ-SCREEN® Grids have strong, durable housings and are an optically synchronized, opposed-mode optoelectronic light grid, requiring no external controller.
- Operates in range up to 70 m
- Resists impact, twisting and abusive environments with a durable aluminum housing
- Exceeds OSHA/ANSI Control Reliability requirements and is certified to cULus NIPF, and complies with Type 4 (IEC 61496) and Category 4 (EN 954)
- Includes blocked beam zone indicators
- Can be combined with other devices, such as mirrors and Points, for a custom configuration
- Cordsets and brackets see page 574

### EZ-SCREEN® Grid Systems

Example Model Number SGP3-533Q88E

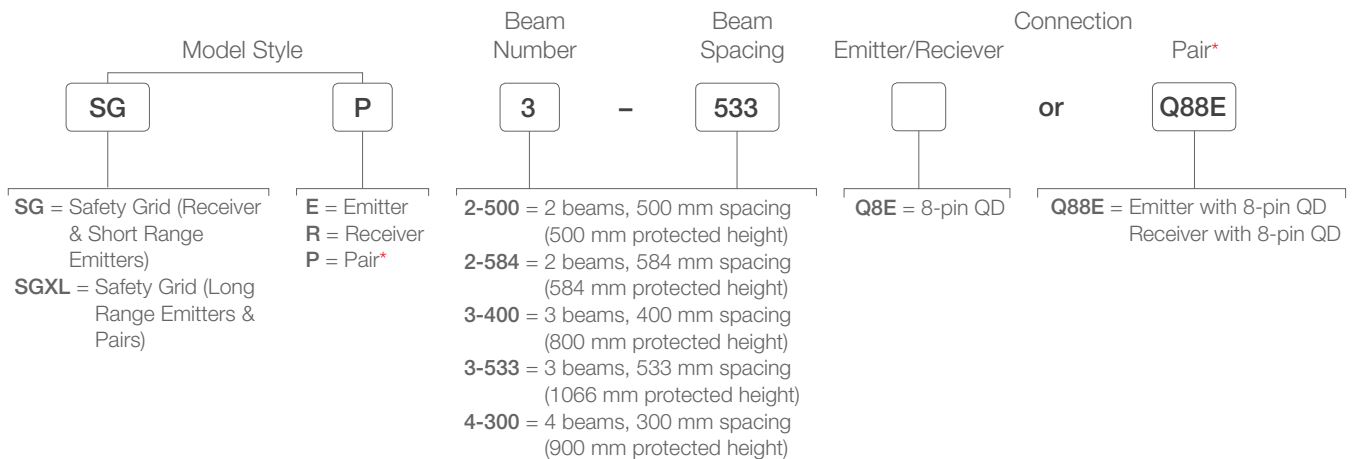

For more specifications see page 575.

 A model with a QD requires a mating cordset (see page 574).

For emitters and receivers with a wiring terminal chamber, remove the Q8E or Q88E from the model number (example, SGE4-300).

For an emitter with a 5-pin Mini QD and TEST function, replace Q8E with Q5 on emitter model numbers (example, SGE4-300Q5) and Q88E with Q85 on pair model numbers (example, SGP4-300Q85).

For emitters with a 3-pin Mini QD, replace Q8E with Q3 (example, SGE4-300Q3); and for receivers with an 8-pin Mini QD, replace Q8E with Q8 on model numbers (example, SGR4-300Q8); or for a pair replace Q88E with Q83 (example, SGP4-300Q83).

\* A pair includes an emitter and receiver (example, SGP3-533Q88E)

Contact Banner Engineering Corp. for additional information and/or verification of valid kit model numbers.

# EZ-SCREEN® Points

## Type 4 Single-Beam Systems



- EZ-SCREEN® Point systems have strong, durable housings and are a synchronized, opposed-mode single optoelectronic light beam, requiring no external controller.
- Operates in range up to 70 m
- Resists impact, twisting and abusive environments with a durable aluminum housing
- Exceeds OSHA/ANSI Control Reliability requirements and is certified to cULus NIPF, and complies with Type 4 (IEC 61496) and Category 4 (EN 954)
- Includes blocked beam zone indicators
- Can be combined with other devices, such as mirrors and Points, for a custom configuration
- Cordsets and brackets see page 574

### EZ-SCREEN® Point Systems

Example Model Number SP3-533Q88E

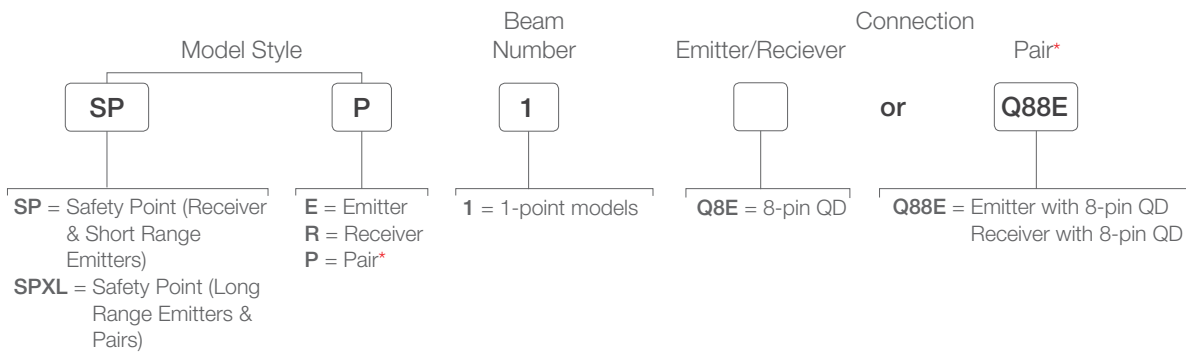

For more specifications see page 575.

 A model with a QD requires a mating cordset (see page 574).

For emitters and receivers with a wiring terminal chamber, remove the Q8E or Q88E from the model number (example, SPE1).

For an emitter with a 5-pin Mini QD and TEST function, replace Q8E with Q5 on emitter model numbers (example, SPE1Q5) and Q88E with Q85 on pair model numbers (example, SP1Q85).

For emitters with a 3-pin Mini QD, replace Q8E with Q3 (example, SPE1Q3); and for receivers with an 8-pin Mini QD, replace Q8E with Q8 on model numbers (example, SPR1Q8); or for a pair replace Q88E with Q83 (example, SPP1Q83).

\* A pair includes an emitter and receiver (example, SPP1Q88E)

Contact Banner Engineering Corp. for additional information and/or verification of valid kit model numbers.



8-Pin\*

**Euro-Style**  
Double-ended  
male/female

<b>DEE2R-81D</b> 0.3 m (1')	<b>DEE2R-825D</b> 7.6 m (25')
<b>DEE2R-83D</b> 0.9 m (3')	<b>DEE2R-850D</b> 15.3 m (50')
<b>DEE2R-88D</b> 2.4 m (8')	<b>DEE2R-875D</b> 22.9 m (75')
<b>DEE2R-815D</b> 4.5 m (15')	<b>DEE2R-8100D</b> 30.5 m (100')



8-Pin

**M12/Euro-Style**  
Straight connector  
models listed

<b>QDE-815D</b> 4.5 m (15')
<b>QDE-825D</b> 7.6 m (25')
<b>QDE-850D</b> 15.3 m (50')
<b>QDE-875D</b> 22.9 m (75')
<b>QDE-8100D</b> 30.5 m (100')



8-Pin

**Euro-Style**  
Straight splitter

<b>CSB-M1280M1280</b>
<b>CSB-M1281M1281</b>
<b>CSB-M1288M1281</b>
<b>CSB-M12815M1281</b>
<b>CSB-M12825M1281</b>

\* For connection to safety BUS gateway/node, a "smart" self-monitored safety module, safety controller or safety PLC see page 771.

Additional cordset information is available.  
See page 758



EZA-MBK-1\*



EZA-MBK-3



EZA-MBK-9

\* Standard brackets included with emitter/receiver.



EZA-MBK-2\*\*



EZA-MBK-4



EZA-MBK-5

\*\* One EZA-MBK-2 adapter bracket kit required per sensor when mounting to MSA series stands.

Use with: Grids & Points—Type 4

Use with: Points—Type 4

Additional bracket information is available.  
See page 729

## Stands



## Mirrors

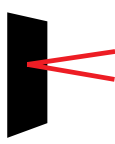

## Interface

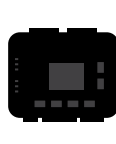

Additional interfacing and accessory information is available.  
See page 802

## Replacement Parts

Model	Description
EZA-AP-1	Access port plug with o-ring
EZA-CP-13	Pg13.5 plug with o-ring
EZA-ECE-1	Emitter wiring chamber end cap (with gasket, captive screws, 3 plugs with o-rings, terminal block)
EZA-ECR-1	Receiver wiring chamber end cap (with gasket, captive screws, 3 plugs with o-rings, terminal block)
EZA-SW-1	Spanner wrench for Grid and Point
EZA-TBE-1	Emitter terminal block
EZA-TBR-1	Receiver terminal block
MGA-K-1	Replacement key for switch MGA-KS0-1
MGA-KS0-1	Panel-mount keyed normally open reset switch
STP-3	Specified test piece, 45 mm dia.

NOTE: See installation manual p/n 112852 for complete list of replacement parts and accessories.





EZ-SCREEN® Grid Systems



EZ-SCREEN® Point Systems

EZ-SCREEN® Grid & Point Specifications

Supply Voltage	24 V dc $\pm$ 15%, 10% max. ripple
Supply Current	<b>Emitter:</b> 150 mA max. <b>Receiver:</b> 500 mA max., exclusive of OSSD1 and OSSD2 loads (up to an additional 0.5A each)
Short Circuit Protection	All inputs and outputs are protected from short circuits to +24 V dc or dc common (except Emitter AUX power connections)
Response Time	24 milliseconds or less from interruption of light grid beam to safety outputs going to OFF-state
EDM Input	+24 V dc signals from external device contacts can be monitored (single-channel, dual-channel or no monitoring) via EDM1 and EDM2 terminals in the receiver. Monitored devices must respond within 200 milliseconds of an output change.
Reset Input	The Reset input must be high (10 to 30 V dc at 30 mA) for 0.25 to 2 seconds and then low (less than 3 V dc) to reset the receiver.
Remote Test Input (optional- available only on certain models)	Test mode is activated either by applying a low signal (less than 3 V dc) to emitter TEST1 terminal for a minimum of 50 milliseconds, or by opening a switch connected between TEST1 and TEST2 terminals for a minimum of 50 milliseconds. Beam scanning stops to simulate a blocked condition. A high signal (10 to 30 V dc, 35 mA inrush, 10 mA max.) at TEST1 terminal deactivates Test mode and allows the emitter to operate normally. TEST1 and TEST2 are factory jumpered on models with wiring chamber.
Safety Outputs	Two diverse-redundant solid-state 24 V dc, 0.5 A max. sourcing OSSD (Output Signal Switching Device) safety outputs. (Use optional interface modules for ac or larger dc loads.) Capable of the Banner "Safety Handshake." <b>ON-State voltage:</b> $\geq$ Vin-1.5 V dc <b>OFF-State voltage:</b> 1.2 V dc max. <b>Max. load resistance:</b> 1000 $\Omega$ <b>Max. load capacitance:</b> 0.1 $\mu$ F <b>OSSD test pulse width:</b> 250 microseconds <b>OSSD test pulse period:</b> 6 milliseconds
Controls and Adjustments	<b>Emitter:</b> Scan code selection: 2-position switch (code 1 or 2). Factory default position is 1. <b>Receiver:</b> Scan code selection: 2-position switch (code 1 or 2). Factory default position is 1. Trip/latch output selection: redundant switches. Factory default position is L (latch) <b>EDM/MPCE monitor selection:</b> redundant switches select between 1- or 2-channel monitoring. Factory default position is 2.
Emitter/Receiver Operating Range	<b>Short-range models:</b> 0.8 m to 20 m <b>Long-range models:</b> 15 m to 70 m Range decreases with use of mirrors and/or lens shields.

Continued on next page

## EZ-SCREEN® Grid &amp; Point Specifications (cont'd)

Beam Spacing	<b>Model SG...4-300:</b> 300 mm <b>Model SG...2-500:</b> 500 mm <b>Model SG...2-584:</b> 584.2 mm	<b>Model SG...3-400:</b> 400 mm <b>Model SG...3-533:</b> 533.4 mm
Beam Diameter	25 mm	
Ambient Light Immunity	> 10,000 lux at 5° angle of incidence	
Strobe Light Immunity	Totally immune to one Federal Signal Corp. "Fireball" model FB2PST strobe	
Emitter Elements	Infrared LEDs, 880 nm at peak emission	
Effective Aperture Angle (EAA)	Meets Type 4 requirements per IEC 61496-2 <b>Short-range models:</b> ± 2.5° @ 3 m      Long-range models: ± 2.5° @ 15 m	
Enclosure	<b>Materials:</b> Extruded aluminum housings with yellow polyester powder finish and well-sealed, rugged molded PBT end caps, acrylic lens cover <b>Rating:</b> NEMA 4, 13; IP65	
Operating Conditions	<b>Temperature:</b> 0° to +50 °C <b>Relative humidity:</b> 95% (non-condensing)	
Shock and Vibration	EZ-SCREEN® systems have passed vibration and shock tests according to IEC 61496-1/-2. This includes vibration (10 cycles) of 10-55 Hz at 0.35 mm single amplitude (0.70 mm peak-to-peak) and shock of 10 g for 16 milliseconds (6,000 cycles).	
Status Indicators	<p>7-Segment Diagnostic Indicators, Both Emitter and Receiver</p> <p>Dash (-) = System is OK            Error Codes = See product manuals (p/n 68410 or 68413) for code definitions and recommended action            Scan code setting = Appears during power-up or after scan code is changed.            (C1 or C2)      (Temporary indication; normal display resumes within a few seconds.)</p> <p><b>Emitter:</b> One bicolor (red/green) Status indicator            Green steady = RUN mode            Green single flashing = TEST mode            Red single flashing = Lockout            OFF = No power to sensor</p> <p><b>Receiver:</b> Two System Status indicators, plus one bi-color (red/green) Beam Status indicator for each beam            Yellow Reset Indicator            ON steady = RUN mode            Double flashing = Waiting for manual reset after power-up            Single flashing = Waiting for manual latch reset            OFF = No power to sensor or system is not ready for operation</p> <p>Bicolor (Red/Green) Status Indicator            Green steady = Outputs ON            Red steady = RUN mode, outputs OFF            Red single flashing = Lockout            OFF = No power to sensor or system is not ready for operation</p> <p>Bicolor (Red/Green) Beam Status Indicators            Green steady = Clear beam, strong signal            Green flickering = Clear beam, weak signal            Red steady = Beam blocked            OFF = No power to sensor or no scanning</p>	
Mounting Hardware	Emitter and receiver each are supplied with a pair of swivel end mounting brackets. Mounting brackets are 8-gauge cold-rolled steel, black zinc finish.	
Cables and Connections	Cables are user-supplied. Wiring terminals accommodate one 22 to 16 ga. wire or two wires up to 18 ga.; Pg 13.5 wiring chamber access port capacity varies, depending on cable gland or strain relief fitting used. Supplied cable gland is for a cable diameter of 6 to 12 mm.	
Design Standards	Designed to comply with Type 4 per IEC 61496-1, -2; Type 4 per UL 61496-1/-2; Category 4 per ISO 13849-1 (EN 954-1)	
Certifications	 	<p><b>Important Notice:</b>            European Community Machinery Directive 2006/42/EC            EZ-SCREEN® grids and points comply with Machinery Directive 98/37/EC, but not with Machinery Directive 2006/42/EC. Therefore, the EZ-SCREEN® grids and points can only be installed as a replacement component within the European Union (EU). For more information, please see <a href="http://www.bannerengineering.com/144763">www.bannerengineering.com/144763</a> or call 1-888-373-6767.</p>

	Description	Models	Product Information
Interface Modules and Controllers	 <ul style="list-style-type: none"> <li>Interface modules provide two or three normally open force-guided relay outputs rated at 6 A (-9 A) or 7 A (-11 A)</li> <li>EZ-SCREEN monitors these interface modules when they are connected to the EZ-SCREEN External Device Monitoring (EDM) inputs</li> <li>Convenient plug-in terminal blocks on a 22.5 mm DIN-rail mountable housing are included</li> </ul>	<p>IM-T-9A (3 NO)</p> <p>IM-T-11A (2 NO/1 NC)</p>	Page 698
	 <ul style="list-style-type: none"> <li>Control system monitors a variety of input devices such as e-stop buttons, rope pulls, enabling devices, protective safety stops, interlocked guards or gates, optical sensors, two-hand controls and safety mats</li> <li>Intuitive programming environment for easy implementation</li> <li>Configure inputs, outputs and functionality of the controller for more usability</li> <li>Base controller allows eight of the 26 inputs to be configured as outputs for efficient terminal utilization</li> <li>Ethernet models available providing up to 64 virtual status outputs, fault diagnostic codes and messages</li> </ul>	<p>SC26-2, XS26-2</p> <p>SC26-2D, XS26-2D</p> <p>SC26-2E, XS26-2E</p> <p>SC26-2DE, XS26-2DE</p>	Page 582
	 <ul style="list-style-type: none"> <li>One controller provides configurable monitoring of multiple safety devices</li> <li>22 input terminals can monitor both contact-based and PNP solid-state input devices</li> <li>3 pairs of independent solid-state safety outputs can be used with selectable one- or two-channel external device monitoring</li> <li>Ten configurable non-safety status outputs track inputs, outputs, lockout, I/O status and other functions</li> <li>All SC22-3 modules use 24 V dc</li> <li>10/100 Base TX Ethernet communication option using EtherNet/IP and Modbus TCP protocols (SC22-3E models)</li> </ul>	<p>SC22-3-S...</p> <p>SC22-3-C...</p> <p>SC22-3E-S...</p> <p>SC22-3E-C...</p>	Page 592
Muting Modules	 <ul style="list-style-type: none"> <li>The Muting Module temporarily inhibits a safety light screen so materials can safely pass through the screen without stopping the machinery</li> <li>The module uses redundant microcontroller-based logic</li> <li>MMD Modules can be used as dual controllers when muting function is not used</li> </ul>	<p>MMD-TA-12B</p> <p>MMD-TA-11B</p>	Page 710
Receiver AC Interface Boxes	 <ul style="list-style-type: none"> <li>Versatile power supplies allow EZ-SCREEN systems to connect to AC power sources</li> <li>Models are available to accommodate receivers only, emitters only or both</li> <li>Receiver models include 8 amp safety relay output</li> </ul>	<p>EZAC-R9-QE8</p> <p>EZAC-R11-QE8</p> <p>EZAC-R15A-QE8-QS83</p> <p>EZAC-R8N-QE8-QS53</p> <p>EZAC-R10N-QE8-QS53</p>	Page 821
Emitter AC Interface Boxes	 <ul style="list-style-type: none"> <li>Versatile power supplies allow EZ-SCREEN systems to connect to AC power sources</li> <li>Models are available to accommodate emitters only</li> <li>Receiver models include 8 amp safety relay output</li> </ul>	<p>EZAC-E-QE8</p> <p>EZAC-E-QE5</p> <p>EZAC-E-QE8-QS3</p> <p>EZAC-E-QE5-QS5</p>	Page 821
Contactors	 <ul style="list-style-type: none"> <li>Pairs of contactors create safety stop circuits with two normally open contacts in series</li> <li>EZ-SCREEN can monitor the circuit because of the contacts' force-guided mechanically linked design</li> <li>Contactors add 10 or 18 amp current carrying capability to any safety system</li> <li>Auxiliary contacts add 3 or 4 normally open contacts</li> <li>Suppressors extend the life of an actuating device that uses a contactor.</li> <li>Modular design simplifies assembly and installation</li> </ul>	<p>Mechanically Linked Contactors</p> <p>11-BG00-31-D-024</p> <p>BF1801L-024</p> <p>Aux. Contacts</p> <p>11-BGX10-40</p> <p>11-G484-30</p> <p>Suppressors</p> <p>11-BGX77-048</p> <p>11-G318-48</p>	Page 822

# EZ-SCREEN® Type 2

## Type 2 Safety Light Screens



- A low-cost solution suited to lower risk applications where the result is only a slight injury.
- Operating range up to 15 m
- Simple, two-piece system requires no control box
- System meets all requirements for Type 2 devices per IEC 61496 and Cat 2 PL d per EN ISO 13849-1 (CE certified) and cULus NIPF
- Fast response times of 11 to 29 milliseconds shutdown machinery quickly
- Dedicated models eliminate selectable functions, DIP switches and programming

### EZ-SCREEN® Type 2 Systems, 30 mm Resolution

Example Model Number LS2TP30-150Q88

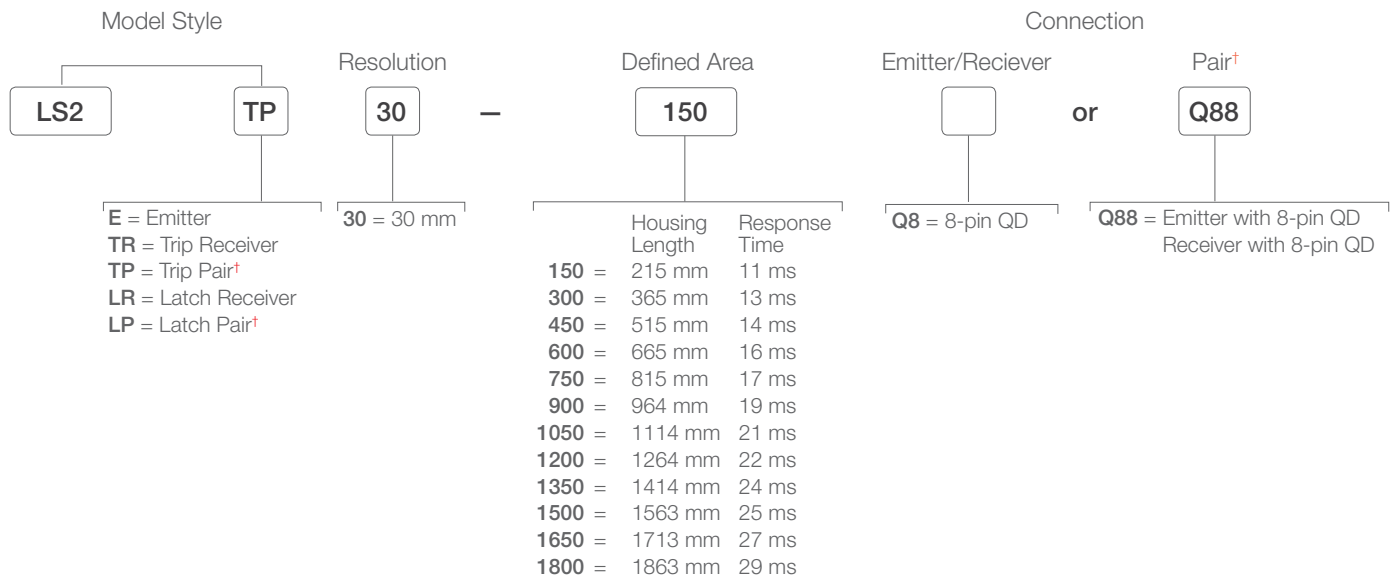

For more specifications see page 581.

 A model with a QD requires a mating cordset.

† A pair includes an emitter and receiver (example, LS2TP30-150Q88)  
 Contact Banner Engineering Corp. for additional information and/or verification of valid kit model numbers.

## INTERLOCK SWITCHES

## TWO-HAND CONTROL

## LASER SCANNERS

## MODULES

**Euro-Style**  
Double-ended  
male/female



8-Pin\*

**DEE2R-81D**  
0.3 m (1')  
**DEE2R-83D**  
0.9 m (3')  
**DEE2R-88D**  
2.4 m (8')  
**DEE2R-815D**  
4.5 m (15')

**DEE2R-825D**  
7.6 m (25')  
**DEE2R-850D**  
15.3 m (50')  
**DEE2R-875D**  
22.9 m (75')  
**DEE2R-8100D**  
30.5 m (100')

**M12/Euro-Style**  
Straight connector  
models listed



8-Pin

**QDE-815D**  
4.5 m (15')  
**QDE-825D**  
7.6 m (25')  
**QDE-850D**  
15.3 m (50')  
**QDE-875D**  
22.9 m (75')  
**QDE-8100D**  
30.5 m (100')

**Euro-Style**  
Straight splitter



8-Pin

**CSB-M1280M1280**  
**CSB-M1281M1281**  
**CSB-M1288M1281**  
**CSB-M12815M1281**  
**CSB-M12825M1281**

\* For connection to safety BUS gateway/node, a "smart" self-monitored safety module, safety controller or safety PLC see page 771.

Additional cordset information is available.  
See page 758



**USCMB-..\*\***



**USMB-1\***



**USMB-6**



**USMB-8**

\* USMB-1 brackets are supplied  
\*\* USCMB-1/-2 are dependent on length

Additional bracket information is available.  
See page 729

**Stands**



**Mirrors**



**Interface**



Additional interfacing and accessory information is available.  
See page 802

## Replacement Parts

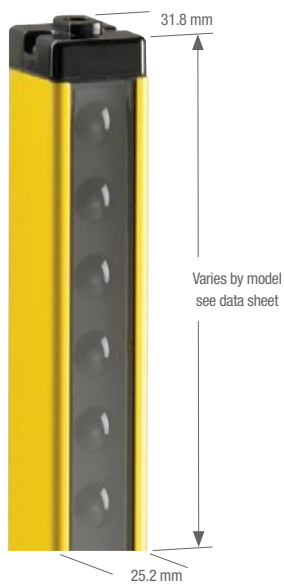

Description	Model
Replacement key for switch MGA-KS0-1	MGA-K-1
Panel-mount keyed normally open reset switch	MGA-KS0-1
30 mm test piece	STP-14
Standard end brackets with hardware to mount to MSA series stands	USMB-1
Center bracket kit and standard end brackets with hardware to mount to MSA series stands (1 bracket, for 600 to 900 mm long sensors)	USCMB-1
Center bracket kit and standard end brackets with hardware to mount to MSA series stands (2 brackets, for 1050 to 1500 mm long sensors)	USCMB-2

NOTE: See installation manual p/n **112852** for complete list of replacement parts and accessories.



EZ-SCREEN®  
Type 2 Systems

## EZ-SCREEN® Type 2 Specifications



Supply Voltage at the Device	24 V dc $\pm$ 20% (PELV) (The external voltage supply must be capable of buffering brief mains interruptions of 20 milliseconds as specified in EN/IEC 60204-1.)
Supply Current	<b>Emitter:</b> 50 mA max. <b>Receiver:</b> 90 mA max., exclusive of OSSD1 and OSSD2 loads (up to an additional 0.5A each)
Wavelength of Emitter Elements	Infrared LEDs, 950 nm at peak emission
Short Circuit Protection	All inputs and outputs are protected from short circuits to +24 V dc or dc common
Electrical Safety Class (IEC 61140)	III
Operating Range	0.2 m to 15 m <b>Range decreases with use of mirrors and/or lens shields:</b> Lens shields – approximately 10% less range per shield Glass-surface mirrors – approximately 8% less range per mirror See Accessory section for more information on a specific mirror, page 806
Effective Aperture Angle (EAA)	Meets Type 2 requirements per IEC 61496-2; $\pm$ 5° @ 3 m
Ambient Light Immunity	> 10,000 lux at 5° angle of incidence
Strobe Light Immunity	Immune as per IEC 61496-2
Response Time	Dependent on number of beams; see Models key on page 578
EDM Input	"Power Monitoring" accomplished via Reset/Remote Test input
Reset Input / Remote Test Input	Connect to +24 V dc via a normally closed (NC) reset switch <b>Auto Rest (Trip Output) Models:</b> Test/Reset <b>Manual Rest (Latch Output) Models:</b> Test/Restart/Reset
Safety Outputs	Two redundant solid-state 24 V dc, 0.5 A max. sourcing OSSD (Output Signal Switching Device) safety outputs. (Use optional interface modules for ac or larger dc loads.) Not compatible with the Banner "Safety Handshake" <b>ON-State voltage:</b> > $V_{in}$ -1.5 V dc <b>OFF-State voltage:</b> 0.2 V dc max. <b>Max. load capacitance:</b> 0.1 $\mu$ F <b>Min. load resistance:</b> 48 $\Omega$ <b>Open ground leakage current:</b> 0.65 mA max. <b>OSSD test pulse width:</b> 0.2 - 0.25 milliseconds <b>OSSD test pulse period:</b> 260 milliseconds typical
Enclosure	<b>Materials:</b> Extruded aluminum housing with yellow polyester powder finish and well-sealed, rugged die-cast zinc end caps, acrylic lens cover <b>Rating:</b> IP65
Operating Conditions	<b>Temperature:</b> 0 to +55 °C <b>Relative humidity:</b> 95% maximum (non-condensing)
Shock and Vibration	EZ-SCREEN® Type 2 components have passed vibration and shock tests according to IEC 61496-1. This includes vibration (10 cycles) of 10-55 Hz at 0.35 mm single amplitude (0.70 mm peak-to-peak) and shock of 10 g for 16 milliseconds (6,000 cycles).
Design Standards	Designed to comply with Type 2 per IEC 61496-1/-2; Category 2 PI d per EN ISO 13849-1; SIL 2 per IEC 61 508; Type 2 per UL 61496-1/-2
Certifications	 



## Safety Controllers

Industrial safety controllers and modules provide an interface between safety devices and the machines; monitoring those devices for an easy-to-use safety control solution.



Series	Description	Inputs	Outputs	Dimensions H x W x D	Features	Power Supply
	<b>SC26-2</b> Easy to program, install and allows for more flexibility of how the controller is used and configured. page 584	26	2 pair (4 PNP)	110 x 45 x 128.4 mm	Programmable Logic Optional Ethernet Optional LCD screen	24 V dc
	<b>XS26-2</b> Easy to program, install and allows for up to eight expansion I/O modules page 588	Dependent on modules used	Dependent on modules used	110 x (varies) x 129 mm (base module is 45 mm each addition module adds 22.5 mm)	Explanable Programmable Logic Optional Ethernet Optional LCD screen	24 V dc
	<b>SC22-3</b> Completely configurable and flexible safety controller that can easily replace multiple dedicated safety modules. page 592	22	3 pair (6 PNP)	112 x 131 x 64 mm	Optional Ethernet Dedicated status outputs LCD screen	24 V dc

# SC26-2

## Safety Controller



- Easy to program, install and allows for more flexibility of how the safety controller is used and configured
- Lower cost option for smaller jobs and applications
- Monitors a variety of input devices such as E-stop buttons, rope pulls, enabling devices, protective safety stops, interlocked guards or gates, optical sensors, two-hand controls and safety mats
- Intuitive programming environment for easy implementation
- Configure inputs, outputs and functionality of the controller for more usability
- Base controller allows eight of the 26 inputs to be configured as status outputs for efficient terminal utilization
- Ethernet models available providing up to 256 status outputs and non-safety virtual outputs
- Accessories see page 586

### SC26-2 Safety Controller

Description	Model
NO Display & NO Ethernet	SC26-2
Display	SC26-2d
Ethernet	SC26-2e
Display + Ethernet	SC26-2de

Start using the software today  
[bannerengineering.com/SC26-2](http://bannerengineering.com/SC26-2)

The next level in machine safety control...

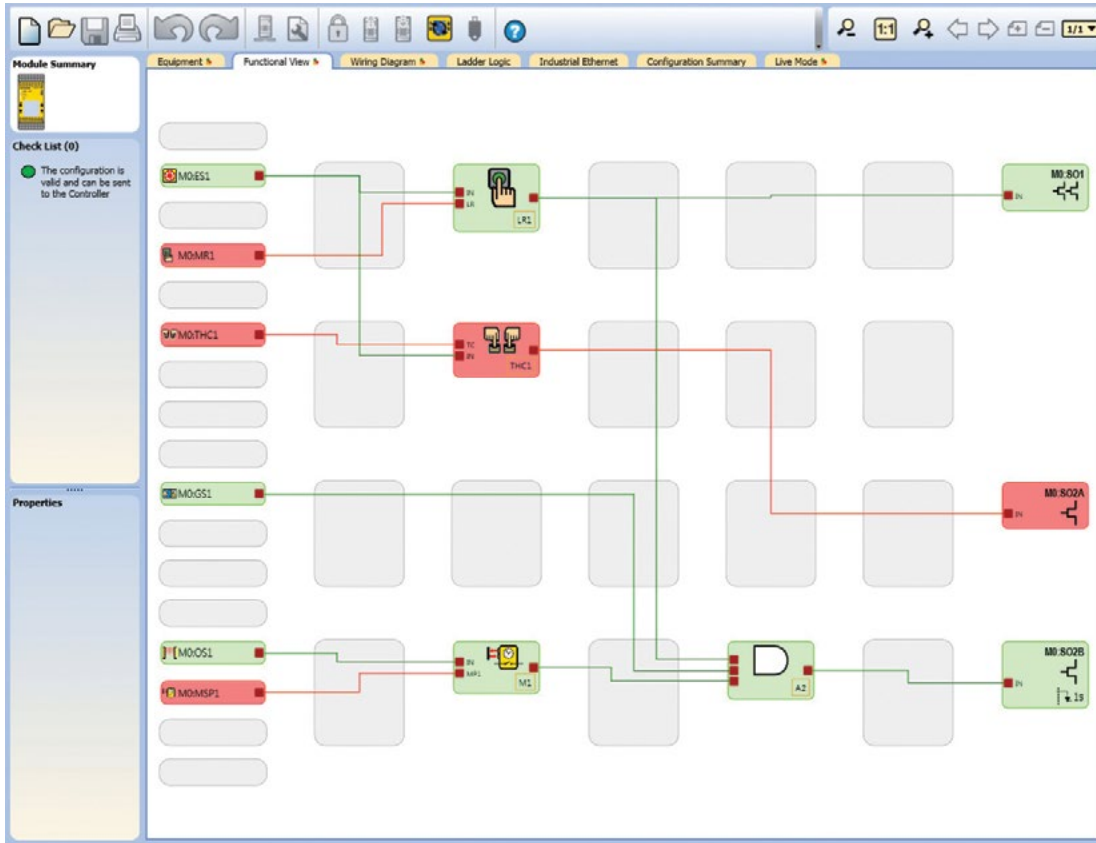

**Target Equipment**

- End-of-line packaging equipment
- Robotic automation
- Safety retrofits
- Welding stations
- Assembly machines

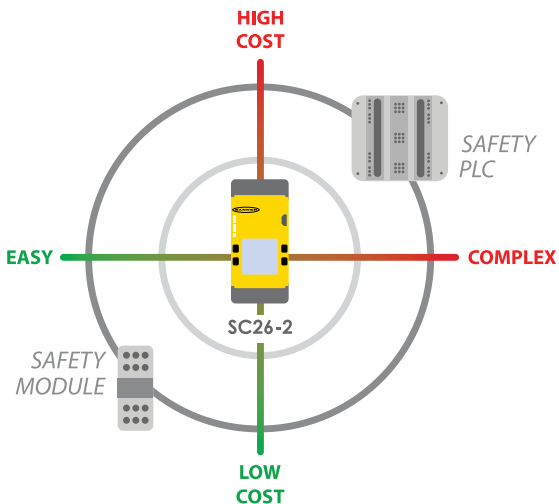

**Safety Input Devices**

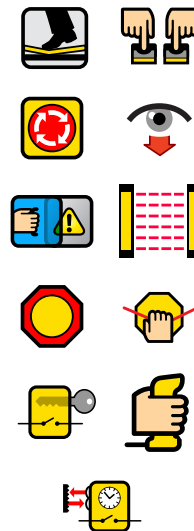



**SC-XM2**  
Memory Card



**SC-XMP2**  
Programming Tool



**SC-USB2**  
USB Cable

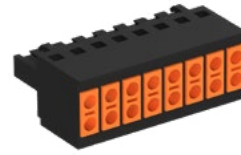





**SC-TC2**  
Spring Terminal Block Set

*Additional Interfacing Products  
see page 595*



SC26-2 Safety Controller Specifications

Power	24 V dc, ± 20% <b>Ethernet models:</b> add 40 mA <b>Display models:</b> add 20 mA
Safety Inputs (and Convertible I/O when used as inputs)	<b>Input On threshold:</b> > 15 V dc (guaranteed on), 30 V dc max. <b>Input Off threshold:</b> < 5 V dc and < 2 mA, -3 V dc min. <b>Input On current:</b> 5 mA typical at 24 V dc, 50 mA peak contact cleaning current at 24 V dc <b>Input lead resistance:</b> 300 Ω max. (150 Ω per lead) <b>Input requirements for a 4-wire Safety Mat:</b> <ul style="list-style-type: none"> <li>• Max. capacity between plates: 0.22µF</li> <li>• Max. capacity between bottom plate and ground: 0.22µF</li> <li>• Max. resistance between the 2 input terminals of one plate: 20 Ω</li> </ul>
Solid State Safety Outputs	0.5 A max. at 24 V dc (1.0 V dc max. drop) <b>Output OFF threshold:</b> 1.7 V dc typical (2.0 V dc max.) <b>Output leakage current:</b> 50 µ A max. with open 0V <b>Load:</b> 0.1 µ F max., 1 H max., 10 Ω max. per lead
Response and Recovery Times	See Configuration Summary in the data sheet
Environmental Rating	NEMA 1 (IEC IP20), for use inside NEMA 3 (IEC IP54) or better enclosure
Operating Conditions	<b>Temperature range:</b> 0 to +55 °C
Mechanical Stress	<b>Shock:</b> 15g for 11 milliseconds, half sine, 18 shocks total (per IEC 61131-2) <b>Vibration:</b> 3.5 mm occasional /1.75 mm continuous @ 5Hz to 9Hz, 1.0g occasional and 0.5g continuous @ 9Hz to 150Hz: all at 10 sweep cycles per axis (per IEC 61131-2)
Removable Terminals	<b>Important:</b> Clamp terminals are designed for 1 wire only. If more than 1 wire is connected to a terminal, a wire could loosen or become completely disconnected from the terminal, causing a short. <b>Wire size:</b> 24 to 16 AWG (0.20 to 1.31 mm <sup>2</sup> ) <b>Wire strip length:</b> 8.00 mm (0.315 in)
Design Standards	<ul style="list-style-type: none"> <li>• SIL CL 3 per IEC 62061 Safety of Machinery – Functional Safety of Safety-Related Electrical, Electronic and Programmable Electronic Control Systems</li> <li>• SIL 3 per IEC 61508 Functional Safety of Electrical/Electronic/Programmable Electronic Safety-Related Systems</li> <li>• Category 4 per ISO 13849-1</li> <li>• Category 4 Performance Level (PL) e per ISO 13849-1</li> <li>• Complies with Machinery Directive 2006/42/EC</li> <li>• IEC 61131-2 Programmable Controllers, Part 2: Equipment Requirements and Tests</li> <li>• UL 508 Industrial Control Equipment</li> <li>• ANSI NFPA 79 Electrical Standards for Industrial Machinery</li> <li>• IEC 60204-1 Electrical Equipment of Machines: General Requirements</li> <li>• ISO 13851 (EN574) Safety of Machinery – Two-Hand Control Devices – Functional Aspects and Design Principles</li> <li>• ISO 13850 (EN418) Emergency Stop Devices</li> </ul>
Certifications	   

# XS26-2

## Safety Controller



- Easy to both program and install while providing scalable flexibility to meet your growing automation needs.
- Allows up to eight expansion modules
- Configuration software free of charge
- Real-time live display feedback
- Intuitive functional diagram configuration; logic function blocks including AND, OR, XOR, NAND, NOR, SR Flip-flop, RS Flip-flop
- Ethernet models available providing up to 256 status outputs and non-safety virtual outputs
- Accessories see page 590

### XS26-2 Safety Controller, 24 V DC

Description	Model
Expandable	XS26-2
Expandable + Display	XS26-2d
Expandable + Ethernet	XS26-2e
Expandable + Display + Ethernet	XS26-2de

### Expansion Modules

Description	Output Configuration	Model*
8 Pin Safety input module	NA	XS8si
16 Pin Safety input module	NA	XS16si
Safety output module	2 dual channel PNP	XS2so
Solid-state safety output module	4 dual channel PNP	XS4so
Safety relay output module	2 NO/1NC	XS1ro
Safety relay output module	4 NO/2 NC	XS2ro

\* All models come with screw terminals

# Build System and Select Equipment

Start using the software today. Go to [bannerengineering.com/xs26-2](http://bannerengineering.com/xs26-2)

## Equipment View

### 1. Add up to 8 modules

### 2. Add safety devices

### 3. Select safety device properties



**SC-XM2**  
Memory Card



**SC-XMP2**  
Programming Tool



**SC-USB2**  
USB Cable

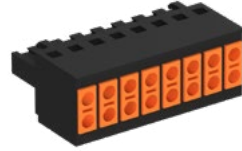





**SC-TC2**  
Spring Terminal Block Set

*Additional Interfacing Products  
see page 595*





XS26-2 Safety Controller Specifications

Power	24 V dc, ± 20% <b>Ethernet models:</b> add 40 mA <b>Display models:</b> add 20 mA <b>Expandable models:</b> add 3.6 A max. bus load
Safety Inputs (and Convertible I/O when used as inputs)	<b>Input On threshold:</b> > 15 V dc (guaranteed on), 30 V dc max. <b>Input Off threshold:</b> < 5 V dc and < 2 mA, -3 V dc min. <b>Input On current:</b> 5 mA typical at 24 V dc, 50 mA peak contact cleaning current at 24 V dc <b>Input lead resistance:</b> 300 Ω max. (150 Ω per lead) <b>Input requirements for a 4-wire Safety Mat:</b> <ul style="list-style-type: none"> <li>• Max. capacity between plates: 0.22µF</li> <li>• Max. capacity between bottom plate and ground: 0.22µF</li> <li>• Max. resistance between the 2 input terminals of one plate: 20 Ω</li> </ul>
Solid State Safety Outputs	<b>Input On threshold:</b> > 15 V dc (guaranteed on), 30 V dc max. <b>Input Off threshold:</b> < 5 V dc and < 2 mA, -3 V dc min. <b>Input On current:</b> 5 mA typical at 24 V dc, 50 mA peak contact cleaning current at 24 V dc <b>Input lead resistance:</b> 300 Ω max. (150 Ω per lead) <b>Input requirements for a 4-wire Safety Mat:</b> <ul style="list-style-type: none"> <li>• Max. capacity between plates: 0.22 µF</li> <li>• Max. capacity between bottom plate and ground: 0.22 µF</li> <li>• Max. resistance between the 2 input terminals of one plate: 20 Ω</li> </ul>
Response and Recovery Times	See Configuration Summary in the data sheet
Environmental Rating	NEMA 1 (IEC IP20), for use inside NEMA 3 (IEC IP54) or better enclosure
Operating Conditions	<b>Temperature range:</b> 0 to +55 °C
Mechanical Stress	<b>Shock:</b> 15g for 11 milliseconds, half sine, 18 shocks total (per IEC 61131-2) <b>Vibration:</b> 3.5 mm occasional / 1.75 mm continuous @ 5Hz to 9Hz, 1.0g occasional and 0.5g continuous @ 9Hz to 150Hz: all at 10 sweep cycles per axis (per IEC 61131-2)
Removable Terminals	<b>Important:</b> Clamp terminals are designed for 1 wire only. If more than 1 wire is connected to a terminal, a wire could loosen or become completely disconnected from the terminal, causing a short. <b>Wire size:</b> 24 to 12 AWG (0.20 to 3.13 mm <sup>2</sup> ) <b>Wire strip length:</b> 7 to 8 mm (0.275 in to 0.315 in)
Design Standards	Category 4, PL e (EN ISO 13849) SIL CL 3 (IEC 62061, IEC 61508)
Certifications	   

# SC22-3/-3E

## Safety Controller



- The SC22-3 Safety Controller is a completely configurable and flexible safety controller that can easily replace multiple dedicated safety modules
- Input terminals can monitor both contact-based or PNP solid-state outputs
- Ten configurable auxiliary status outputs track inputs, outputs, lockout, I/O status and other functions
- Three pairs of solid-state safety outputs with ON-Delay, OFF-Delay and cancel OFF-Delay
- SC22-3E models provide diagnostic information using EtherNet/IP, Modbus TCP and PCCC
- Safety Controller is designed to meet stringent standards including Safety Integrity Level (SIL) 3 per IEC 61508, SIL CL 3 per IEC 62061 and Category 4 Performance Level (PL e) per EN ISO 13849-1
- Accessories see page 594

### SC22-3/-3E Safety Controller, 24 V DC

Terminal Type	Safety Outputs	USB Cable	Output Rating	Aux. Outputs	XM Card	XM Programming Tool	Communication Protocol	Model
Screw	3 pairs (6 PNP)	1.8 m	0.75 amps each output	10 status (I/O, mute, lockout, fault and reset)	Yes	Yes	—	SC22-3-SU1
Clamp								SC22-3-CU1
Screw	3 pairs (6 PNP)	—	0.75 amps each output	10 status (I/O, mute, lockout, fault and reset)	Yes	—	—	SC22-3-S
Clamp								SC22-3-C
Screw	3 pairs (6 PNP)	1.8 m	0.5 amps each output	10 status (I/O, mute, lockout, fault and reset) plus 32 virtual status	Yes	Yes	EtherNet/IP (with PCCC) & Modbus/TCP	SC22-3E-SU1
Clamp								SC22-3E-CU1
Screw	3 pairs (6 PNP)	—	0.5 amps each output	10 status (I/O, mute, lockout, fault and reset) plus 32 virtual status	Yes	—	EtherNet/IP & Modbus/TCP	SC22-3E-S
Clamp								SC22-3E-C

**Intuitive free software for point-and-click configuration**

1. Select the type of safety input device
2. Map functions and properties from a pull down list
3. Wiring and ladder logic diagrams autopopulate along with configuration summary
  - View and track status using front panel display or PC "Live Display"
  - Includes fault history with time/date stamp
  - Use INFO button to link to software and manual for quick reference to devices and safety category 2, 3 or 4 hookup

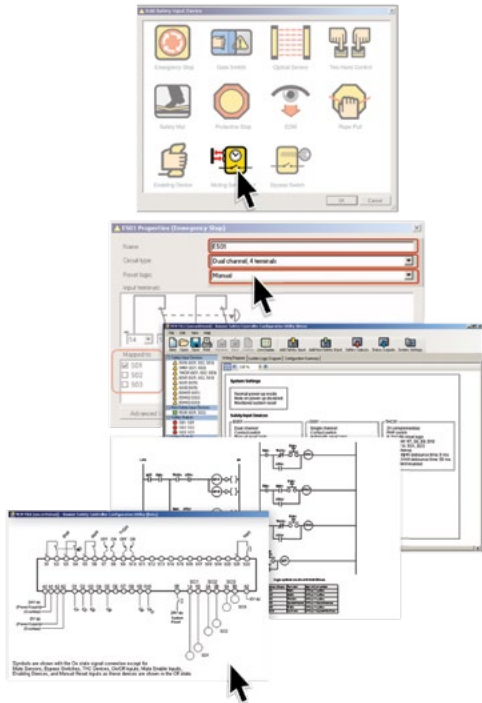

**22 input terminals for monitoring safety and non-safety devices**

Versatile input circuitry accommodates a wide range of inputs from Banner devices or any other manufacturer, including:

- |                      |                       |                       |
|----------------------|-----------------------|-----------------------|
| E-stop Buttons       | Safety Mats and Edges | Interlocking Switches |
| Two-Hand Controls    | Enabling Devices      | Laser Scanners        |
| Safety Light Screens | Muting Sensors        | Value monitoring      |
| Rope Pulls           | Bypass Switches       |                       |

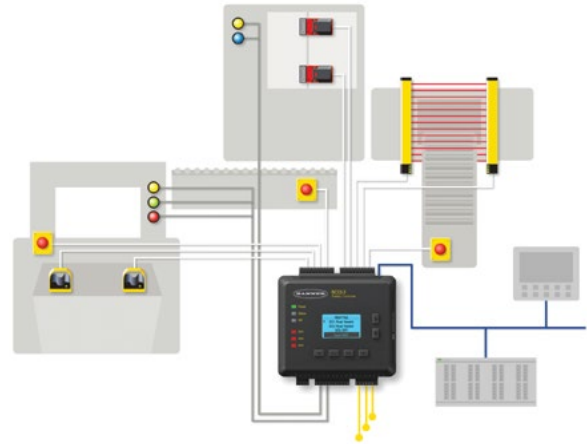

## Ethernet Communication



**Shielded**  
**STP07**  
 2 m (7')  
**STP25**  
 7 m (25')  
**STP50**  
 15 m (50')  
**STP75**  
 23 m (75')

**Shielded  
 Crossover**  
**STPX07**  
 2 m (7')  
**STPX25**  
 7 m (25')  
**STPX50**  
 15 m (50')  
**STPX75**  
 23 m (75')

*Additional cordset information is available  
 See page 758*



DIN-35..

*Additional bracket information is available  
 See page 729*

## Miscellaneous



Description	Model
SC22-3 replacement controller (without terminals)	SC-SC22-3
SC22-3E replacement controller (without terminals), Ethernet compatible	SC-SC22-3E
External memory card (XM card)	SC-XM1
Bulk pack of 5 XM Cards	SC-XM1-5
Screw terminal replacement set	SC-TS1
Clamp terminal replacement set	SC-TC1
USB A/B cable, 1.8 m	SC-USB1
XM card USB programming tool	SC-XMP

SC22-3/-3E Interface Modules

Description	Supply Voltage	Inputs (Safety Controller Outputs)	Safety Outputs	Output Rating	EDM Contacts	Model
For use with 1-dual channel SC22-3 safety output	24 V dc (Controller supplied)	1 Pair (SO1)	3 NO	10 amps	1 NC pair per output	SC-IM9A
For use with 2-dual channel SC22-3 safety outputs	24 V dc (Controller supplied)	2 Pair (SO1 and SO2)	Total of 6 (3 NO per output)	10 amps	1 NC pair per output	SC-IM9B
For use with 3-dual channel SC22-3 safety outputs	24 V dc (Controller supplied)	3 Pair (SO1, SO2 and SO3)	Total of 9 (3 NO per output)	10 amps	1 NC pair per output	SC-IM9C

NOTE: External device monitoring (EDM) is required to be wired separately to the NC contacts to comply with ISO 13849-1 categories and ANSI/OSHA control reliability.

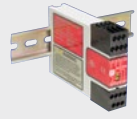
Additional Interfacing Products

	Description	Models	Product Information
Interface Modules	 <ul style="list-style-type: none"> <li>Interface modules provide two or three normally open force-guided relay outputs rated at 6 A</li> <li>Convenient plug-in terminal blocks on a 22.5 mm DIN-rail mountable housing are included</li> </ul>	<p>IM-T-9A (3 NO)</p> <p>IM-T-11A (2 NO/1 NC)</p>	Page 698
Mechanically Linked Contactors	 <ul style="list-style-type: none"> <li>Contactors add 10 or 18 amp current carrying capability to any safety system</li> <li>Suppressors extend the life of an actuating device that uses a contactor</li> <li>Modular design simplifies assembly and installation</li> </ul>	<p>11-BG00-31-D-024</p> <p>BF1801L-024</p>	Page 822

NC = Normally closed, NO = Normally open

NOTE: External device monitoring (EDM) is required to be wired separately to the NC contacts to comply with ISO 13849-1 categories and ANSI/OSHA control reliability.

## SC22-3/-3E Safety Controller Specifications

Power	24 V dc, $\pm 20\%$ <b>SC22-3 models:</b> 0.4 A (controller only), 5.9 A (all outputs ON @ full rated load) <b>SC22-3E models:</b> 0.4 A (controller only), 4.9 A (all outputs ON @ full rated load) The Controller should be connected only to a SELV (safety extra-low voltage, for circuits without earth ground) or a PELV (protected extra-low voltage, for circuits with earth ground) power supply	
Safety and Non-Safety Inputs (22 terminals)	<b>Input ON threshold:</b> > 15 V dc (guaranteed on), 30 V dc max. <b>Input OFF threshold:</b> < 5 V dc (guaranteed off with any 1 fault), -3 V dc min. <b>Input ON current:</b> 8 mA typical @ 24 V dc, > 2 mA (guaranteed with 1 fault) 50 mA peak contact cleaning current @ 24 V dc <b>Sourcing current:</b> 30 mA minimum continuous (3 V dc max. drop) <b>Input lead resistance:</b> 300 $\Omega$ max. (150 $\Omega$ per lead) <b>Input requirements for a 4-wire safety mat:</b> Max. capacity between plates: 0.5 $\mu$ F Max. capacity between bottom plate and ground: 0.5 $\mu$ F Max. resistance between the 2 input terminals of one plate: 20 $\Omega$	
Safety Outputs (6 terminals, 3 redundant outputs)	<b>Rated output current:</b> <b>SC22-3 models:</b> 0.75 A max. each output (1.0 V dc max drop) <b>SC22-3E models:</b> 0.5 A max. each output (1.0 V dc max drop) <b>Output OFF threshold:</b> 0.6 V dc typical (1.2 V dc max. guaranteed with 1 fault) <b>Output leakage current:</b> 50 $\mu$ A max. with open 0 V <b>Load:</b> 0.1 $\mu$ F max., 1 H max., 10 $\Omega$ max. per lead	
Status Outputs (10 terminals)	<b>Rated output current:</b> 0.5A @ 24 V dc (individual), 1.0 A @ 24 V dc (total of all outputs) <b>O1 to O8 (General Purpose) — Output OFF voltage:</b> < 0.5 V dc (no load), 22 K $\Omega$ pull down to 0 V <b>O9 and O10 (General Purpose or Monitored Mute Lamp) — Output OFF voltage:</b> Internal 94 K $\Omega$ pull up to 24 V dc supply <b>Output ON/OFF threshold:</b> 15 V dc +/-4 V dc @ 24 V dc supply  NOTE: For O9 and O10 (if configured as monitored mute lamp output only), if a short circuit or other fault condition causes the output to drop below this threshold while the output is ON, a lockout will occur. If an open circuit or other fault condition causes the output to rise above this threshold while the output is OFF, a lockout will occur.	
Network Interface (SC22-3E only)	Ethernet 10/100 Base-T/TX, RJ45 modular connector Selectable auto negotiate or manual rate and duplex Auto MDI/MDIX (Auto cross) <b>Protocols:</b> EtherNet/IP (with PCCC), Modbus TCP <b>Data:</b> 32 configurable virtual status outputs; fault diagnostic codes and messages; access to fault log	
Response and Recovery Times	<b>Response time (ON to OFF):</b> 10 milliseconds max. (with standard 6 milliseconds debounce; this can increase if debounce time increases. Refer to the configuration summary for actual response time.) <b>Recovery time (OFF to ON):</b> 400 milliseconds max. (with manual reset option) <b>Recovery time (OFF to ON):</b> 400 milliseconds max. plus input debounce time (auto reset)	
Onboard LCD Information Display— Password Requirements	<b>Password is not required:</b> Run mode (I/O status) Fault (I/O fault detection and remedial steps) Review configuration parameters (I/O properties and terminals)	<b>Password is required:</b> Configuration mode (create/modify/confirm/download configurations)
Environmental Rating	NEMA 1 (IEC IP20), for use inside NEMA 3 (IEC IP54) or better enclosure	
Operating Conditions	<b>Temperature range:</b> 0 to +55 $^{\circ}$ C	
Mechanical Stress	<b>Shock:</b> 15g for 11 milliseconds, half sine, 18 shocks total (per IEC 61131-2) <b>Bump:</b> 10g for 16 milliseconds, 6000 cycles total (per IEC 61496-1) <b>Vibration:</b> 3.5 mm occasional / 1.75 mm continuous @ 5Hz to 9Hz, 1.0g occasional and 0.5g continuous @ 9Hz to 150Hz: (per IEC 61131-2) and 0.35 mm single amplitude / 0.70 mm peak-to-peak @ 10 to 55Hz (per IEC 61496-1), all @ 10 sweep cycles per axis	
EMC	Meets or exceeds all EMC requirements in IEC 61131-2, IEC 61496-1 (Type 4), and IEC 62061 Annex E, Table E.1 (increased immunity levels)	

SC22-3/-3E Safety Controller Specifications (cont'd)





<p><b>Removable Terminals</b></p>	<p>Screw terminals  <b>Wire sizes:</b> 16, 18, 20, 22 or 24 AWG (0.20 – 1.31 mm<sup>2</sup>) Wire strip length: 5.00 mm  <b>Tightening torque:</b> 0.23 Nm (2 in. lbs) nominal Tightening torque: 0.34 Nm (3.0 in. lbs) maximum</p> <p>Clamp terminals  <b>Wire size:</b> 16, 18, 20, 22, or 24 AWG (0.20 – 1.31 mm<sup>2</sup>) Wire strip length: 9.00 mm  <b>Important:</b> Clamp terminals are designed for 1 wire only. If more than 1 wire is connected to a terminal, a wire could loosen or become completely disconnected from the terminal, causing a short.</p>
<p><b>Design Standards</b></p>	<ul style="list-style-type: none"> <li>• SIL CL 3 per IEC 62061 Safety of Machinery – Functional Safety of Safety-Related Electrical, Electronic and Programmable Electronic Control Systems</li> <li>• SIL 3 per IEC 61508 Functional Safety of Electrical/Electronic/Programmable Electronic Safety-Related Systems</li> <li>• Category 4 per ISO 13849-1</li> <li>• Category 4 Performance Level (PL) e per ISO 13849-1</li> <li>• Complies with Machinery Directive 2006/42/EC</li> <li>• IEC 61131-2 Programmable Controllers, Part 2: Equipment Requirements and Tests</li> <li>• UL 508 Industrial Control Equipment</li> <li>• UL 1998 Software in Programmable Components</li> <li>• ANSI NFPA 79 Electrical Standards for Industrial Machinery</li> <li>• IEC 60204-1 Electrical Equipment of Machines: General Requirements</li> <li>• ISO 13851 (EN574) Safety of Machinery – Two-Hand Control Devices – Functional Aspects and Design Principles</li> <li>• ISO 13850 (EN418) Emergency Stop Devices</li> </ul>
<p><b>Certifications</b></p>	



## Emergency Stop Buttons

Push-to-stop/twist-to-release Emergency Stop palm buttons are available in panel-mount or remotely located IP65 enclosures. Illuminated models help operators quickly identify actuated buttons, allowing for a quick return to normal operations.



Series	Description	Options	Mounting	Dimensions H x W x D	Protection Rating
	Easy to install 30 mm mount. page 600	Non-Illuminated Illuminated	30 mm	119.8 x ø 80 mm	IP65
	Flat mount with wide variety of options. page 601	Non-Illuminated Illuminated Non-Illuminated Locking Illuminated Locking	Flat mount	102.1 x 80.8 x 80.3 mm	IP65
	Panel mount E-Stop buttons. page 612	Non-Illuminated Illuminated Locking Illuminated Locking	Panel	Varies by model	IP65
	Mechanical E-Stop button kits. page 616	High current Metal shaft	Panel or flat	106 x 70 x 70 mm	IP65

# E-Stop Buttons

## Illuminated 30 mm Mount



- Illumination allows for easy identification of which E-stop has been activated.
- Easy installation and no assembly or individual wiring required
- Push-to-stop, twist-to-release or pull-to-release operation per IEC 60947-5-5
- Compliant with ANSI B11.19, ANSI NFPA79 and IEC/EN 60204-1 Emergency Stop requirements
- Incorporate with OTB/STB optical touch button for a simplified operator station that does not require an additional enclosure.
- “Safe Break Action” ensures NC contacts will open if the contact block is damaged or separated from the actuator
- Models designed to interface with Safety BUS nodes/gateways

## Illuminated Base-mount E-Stop Push-Buttons

Description	Illumination***	Models
2NC / 1NO (PNP)	YEL/RED-Flash/Solid	SSA-EB1PLYR-12ECQ8
2NC / 1NO (PNP)	GREEN/RED-Flash/Solid	SSA-EB1PLGR-12ECQ8
2NC / 1NO (PNP)	OFF/RED-Flash/Solid	SSA-EB1PLXR-12ECQ8
2NC / 1NO (PNP)	OFF/RED-Flash/Solid, with 60 mm button	SSA-EB2PLXR-12ECQ8
2NC / 1NO (PNP)	OFF/RED-Solid/Solid	SSA-EB1PL-12ECQ8
2NC – Safety BUS node compatible*	YEL/RED-Flash	SSA-EB1PLYR-02ECQ5A
2NC – Safety BUS node compatible*	OFF/RED-Flash	SSA-EB1PLXR-02ECQ5A
2NC – Safety BUS node compatible*	OFF/RED-Solid	SSA-EB1PL-02ECQ5A
2NC – Safety BUS node compatible*	Illuminated button, OFF (armed), RED (solid, PUSH ON)	SSA-EB1PL2-02ECQ5A
2NC – Safety BUS node compatible**	YEL/RED-Flash	SSA-EB1PLYR-02ECQ5B
2NC – Safety BUS node compatible**	OFF/RED-Flash	SSA-EB1PLXR-02ECQ5B
2NC – Safety BUS node compatible**	OFF/RED-Solid	SSA-EB1PL-02ECQ5B
2NC – Safety BUS node compatible**	Illuminated button, OFF (armed) RED (solid, PUSH ON)	SSA-EB1PL2-02ECQ5B

For more specifications see page 609.

Connection options: A model with a QD requires a mating cordset (see page 606).

\* CH1 = pins 1 & 2, CH2 = pins 4 & 5, 5-pin M12 QD

\*\* CH1 = pins 1 & 4, CH2 = pins 2 & 5, 5-pin M12 QD

\*\*\* For EZ-LIGHT Illumination logic see page 607.

# E-Stop Buttons

## Illuminated Flush Mount



- Illumination allows for easy identification of which E-stop has been activated.
- Easy installation with no assembly or individual wiring required
- Remotely located E-Stop buttons can be positioned to be clearly identified, clearly visible and readily accessible
- Push-to-stop, twist-to-release or pull-to-release operation per IEC 60947-5-5
- Compliant with ANSI B11.19, ANSI NFPA79 and IEC/EN 60204-1 Emergency Stop requirements
- “Safe Break Action” ensures NC contacts will open if the contact block is damaged or separated from the actuator
- Models designed to interface with Safety BUS nodes/gateways

### Illuminated Flush-mount E-Stop Push-Buttons

Description	Illumination***	Models
2NC / 1NO (PNP)	YEL/RED-Flash/Solid	SSA-EB1PLYR-12ED1Q8
2NC / 1NO (PNP)	YEL/RED-Flash/Solid, 1/2" NPT conduit connection with terminal strip	SSA-EB1PLYR-12ED1
2NC / 1NO (PNP)	GREEN/RED-Flash/Solid	SSA-EB1PLGR-12ED1Q8
2NC / 1NO (PNP)	GREEN/RED-Flash/Solid, 1/2" NPT conduit connection with terminal strip	SSA-EB1PLGR-12ED1
2NC / 1NO (PNP)	OFF/RED-Flash/Solid	SSA-EB1PLXR-12ED1Q8
2NC / 1NO (PNP)	OFF/RED-Flash/Solid, with 60 mm button	SSA-EB2PLXR-12ED1Q8
2NC / 1NO (PNP)	OFF/RED-Flash/Solid, 1/2" NPT conduit connection with terminal strip	SSA-EB1PLXR-12ED1
2NC / 1NO (PNP)	OFF/RED-Solid/Solid	SSA-EB1PL-12ED1Q8
2NC – Safety BUS node compatible*	YEL/RED-Flash	SSA-EB1PLYR-02ED1Q5A
2NC – Safety BUS node compatible*	OFF/RED-Flash	SSA-EB1PLXR-02ED1Q5A
2NC – Safety BUS node compatible*	OFF/RED-Solid	SSA-EB1PL-02ED1Q5A
2NC – Safety BUS node compatible**	YEL/RED-Flash	SSA-EB1PLYR-02ED1Q5B
2NC – Safety BUS node compatible**	OFF/RED-Flash	SSA-EB1PLXR-02ED1Q5B
2NC – Safety BUS node compatible**	OFF/RED-Solid	SSA-EB1PL-02ED1Q5B

For more specifications see page 609.

Connection options: A model with a QD requires a mating cordset (see page 606).

\* CH1 = pins 1 & 2, CH2 = pins 4 & 5, 5-pin M12 QD  
 \*\* CH1 = pins 1 & 4, CH2 = pins 2 & 5, 5-pin M12 QD  
 \*\*\* For EZ-LIGHT Illumination logic see page 607.

# E-Stop Buttons

## 30 mm Mount



- Allows for easy installation with no assembly or individual wiring required
- Rugged design
- Push-to-stop, twist-to-release or pull-to-release operation per IEC 60947-5-5
- Compliant with ANSI B11.19, ANSI NFPA79 and IEC/EN 60204-1 Emergency Stop requirements
- “Safe Break Action” ensures NC contacts will open if the contact block is damaged or separated from the actuator
- Models designed to interface with Safety BUS nodes/gateways

## Base-mount E-Stop Push-Buttons

Description	Models
2NC	SSA-EB1P-02ECQ4
1NC / 1NO	SSA-EB1P-11ECQ4
2NC – Safety BUS node compatible*	SSA-EB1P-02ECQ5A
2NC – Safety BUS node compatible with 60 mm button*	SSA-EB2P-02ECQ5A
2NC – Safety BUS node compatible**	SSA-EB1P-02ECQ5B
2NC – Safety BUS node compatible with 60 mm button**	SSA-EB2P-02ECQ5B
2NC / 2NO	SSA-EB1P-22ECQ8
4NC with 60 mm button	SSA-EB2P-04ECQ8

For more specifications see page 609.

 Connection options: A model with a QD requires a mating cordset (see page 606).

\* CH1 = pins 1 & 2, CH2 = pins 4 & 5, 5-pin M12 QD

\*\* CH1 = pins 1 & 4, CH2 = pins 2 & 5, 5-pin M12 QD

# E-Stop Buttons

## Flush Mount



- Easy to install with no assembly or individual wiring required
- Models designed to interface with Safety BUS nodes/gateways
- Rugged design
- Push-to-stop, twist-to-release or pull-to-release operation per IEC 60947-5-5
- Compliant with ANSI B11.19, ANSI NFPA79 and IEC/EN 60204-1 Emergency Stop requirements
- “Safe Break Action” ensures NC contacts will open if the contact block is damaged or separated from the actuator

### Flush-Mount E-Stop Push-Button

Description	Standard Models
2NC	SSA-EB1P-02ED1Q4
2NC - Alternate pinout	SSA-EB1P-02ED1Q4A
1NC/1NO	SSA-EB1P-11ED1Q4
2NC, Safety BUS node compatible*	SSA-EB1P-02ED1Q5A
2NC, Safety BUS node compatible with 60 mm button*	SSA-EB2P-02ED1Q4A
2NC, Safety BUS node compatible**	SSA-EB1P-02ED1Q5B
2NC, Safety BUS node compatible with 60 mm button**	SSA-EB2P-02ED1Q4B
2NC/2NO	SSA-EB1P-22ED1Q8
4NC with 60 mm button	SSA-EB2P-04ED1Q8
2NC/1NO, Illuminated button—Push ON RED	SSA-EB1PL2-12ED1Q8

For more specifications see page 609.

Connection options: A model with a QD requires a mating cordset (see page 606).

\* CH1 = pins 1 & 2, CH2 = pins 4 & 5, 5-pin M12 QD

\*\* CH1 = pins 1 & 4, CH2 = pins 2 & 5, 5-pin M12 QD

# Lockable E-Stop Buttons

## Illuminated Flush Mount



- Easy to install and have a locking capability
- Push-to-stop, twist-to-release operation per IEC 60947-5-5
- Compliant with ANSI B11.19, ANSI NFPA79 and IEC/EN 60204-1 Emergency Stop requirements
- "Safe Break Action" ensures NC contacts will open if the contact block is damaged or separated from the actuator
- Models designed to interface with Safety BUS nodes/gateways
- Rugged design is easy to install with no assembly or individual wiring required

### Lockable Illuminated Flush-mount E-Stop Push-Buttons

Description	Illumination*	Models
2NC / 1NO (PNP)	YEL/RED-Flash/Solid	SSA-EB1MLYRP-12ED1Q8
2NC / 1NO (PNP)	YEL/RED-Flash/Solid, 1/2" NPT conduit connection with terminal strip	SSA-EB1MLYRP-12ED1Q8
2NC / 1NO (PNP)	GREEN/RED-Flash/Solid	SSA-EB1MLGRP-12ED1Q8
2NC / 1NO (PNP)	GREEN/RED-Flash/Solid, 1/2" NPT conduit connection with terminal strip	SSA-EB1MLGRP-12ED1
2NC / 1NO (PNP)	OFF/RED-Flash/Solid	SSA-EB1MLXRP-12ED1Q8
2NC / 1NO (PNP)	OFF/RED-Flash/Solid, 1/2" NPT conduit connection with terminal strip	SSA-EB1MLXRP-12ED1
2NC / 1NO (PNP)	OFF/RED-Solid/Solid	SSA-EB1MLP-12ED1Q8

For more specifications see page 610.

 Connection options: A model with a QD requires a mating cordset (see page 606).

\* For EZ-LIGHT Illumination logic see page 607.

# Lockable E-Stop Buttons

## Flush Mount



- Easy to install and have a locking capability.
- Push-to-stop, twist-to-release operation per IEC 60947-5-5
- Compliant with ANSI B11.19, ANSI NFPA79 and IEC/EN 60204-1 Emergency Stop requirements
- “Safe Break Action” ensures NC contacts will open if the contact block is damaged or separated from the actuator
- Models designed to interface with Safety BUS nodes/gateways
- Rugged design is easy to install with no assembly or individual wiring required

### Lockable Flush-mount E-Stop Push-Button

Description	Models
2NC	SSA-EB1MP-02ED1Q4
2NC - Alternate pinout	SSA-EB1MP-02ED1Q4A
1NC/1NO	SSA-EB1MP-11ED1Q4
2NC, Safety BUS node compatible*	SSA-EB1MP-02ED1Q5A
2NC, Safety BUS node compatible**	SSA-EB1MP-02ED1Q5B
2NC/2NO	SSA-EB1MP-22ED1Q8
2NC/1NO, Illuminated button—Push ON RED	SSA-EB1ML2P-12ED1Q8

For more specifications see page 609.

 Connection options: A model with a QD requires a mating cordset (see page 606).

\* CH1 = pins 1 & 2, CH2 = pins 4 & 5, 5-pin M12 QD  
 \*\* CH1 = pins 1 & 4, CH2 = pins 2 & 5, 5-pin M12 QD

**Series Hookup Cordset Solution**

This interconnection solution allows for quick hookup of a series string of emergency stop buttons. For the CSS models (A) Branch #1 and Branch #2 are 300 mm (12") in length and the length of the trunk is listed below. See "Cordsets" below and specific model E-Stop datasheet for complete information, including installation instructions, hookup, and accessories.

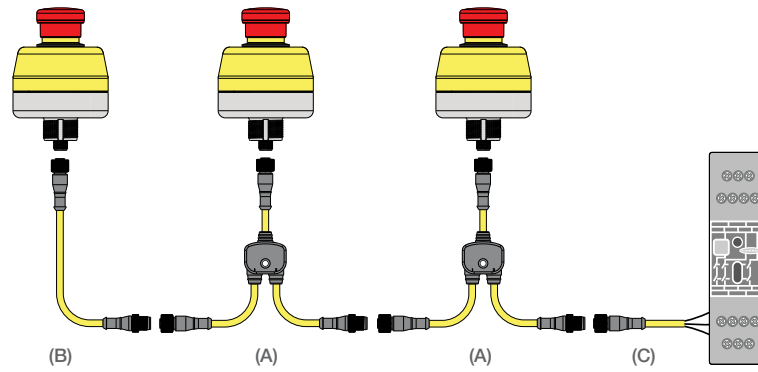

**(A)**  
Euro-Style  
Straight splitter

4-Pin	
CSS-M12F41M12M41M12F41	0.3 m (1')
CSS-M12F43M12M41M12F41	0.9 m (3')
CSS-M12F48M12M41M12F41	2.4 m (8')
8-Pin	
CSS-M12F81M12M81M12F81	0.3 m (1')
CSS-M12F83M12M81M12F81	0.9 m (3')
CSS-M12F88M12M81M12F81	2.4 m (8')



**(B)**  
Euro-Style  
Double-ended  
male/female

5-Pin	8-Pin
DEE2R-51D	DEE2R-81D
0.3 m (1')	0.3 m (1')
DEE2R-53D	DEE2R-83D
0.9 m (3')	0.9 m (3')
DEE2R-58D	DEE2R-88D
2.4 m (8')	2.4 m (8')
DEE2R-515D	DEE2R-815D
4.5 m (15')	4.5 m (15')
DEE2R-525D	DEE2R-825D
7.6 m (25')	7.6 m (25')
DEE2R-550D	DEE2R-850D
15.3 m (50')	15.3 m (50')
DEE2R-575D	DEE2R-875D
22.9 m (75')	22.9 m (75')
DEE2R-5100D	DEE2R-8100D
30.5 m (100')	30.5 m (100')



**(C)**  
M12/Euro-Style  
Straight connector  
models listed

4-Pin	8-Pin
MQDC-406	MQDC2S-806
2 m (6')	2 m (6')
MQDC-415	MQDC2S-815
5 m (25')	5 m (25')
MQDC-430	MQDC2S-830
9 m (50')	9 m (50')
MQDC-450	MQDC2S-850
15 m (50')	15 m (50')

Additional cordset information is available.  
See page 758



SSA-MBK-EEC1



SSA-MBK-EEC2



SSA-MBK-EEC3





SSA-EB1P-ECWC

Additional bracket information is available.  
See page 752



E-Stop Legend Labels (adhesive backed label)

Product	Description	Language	Inscription	Models
	60 mm diameter (OD) Emergency Stop Legend with inscription and ISO 13850 Emergency Stop symbol (adhesive backed label).  41 mm hole for application around the base of <b>SSA-EB1(2)P...</b> (Pack of 10 each)	English	EMERGENCY STOP	ESL-41/60-10
		English & Spanish	PARADA DE EMERGENCIA	ESL-41/60-ENES-10
		Spanish	PARADA DE EMERGENCIA	ESL-41/60-ES-10
		German	NOT-AUS	ESL-41/60-DE-10
		French	ARRÊT D'URGENCE	ESL-41/60-FR-10
		Italian	EMERGENZA ARRESTO	ESL-41/60-IT-10
		Russian	БГ БСЙКОб К ПТУБОПГ	ESL-41/60-RU-10
		Japanese	非常停止	ESL-41/60-JA-10
		Simplified Chinese (Mainland China)	紧急停止	ESL-41/60-CN-10
		Traditional Chinese (Taiwan)	緊急停止	ESL-41/60-TW-10
	70 mm diameter (OD) Emergency Stop Legend with inscription and ISO 13850 Emergency Stop symbol (adhesive backed label).  44 mm hole for application around <b>SSA-EB1M...</b> (Pack of 10 each).	English	EMERGENCY STOP	ESL-44/70-10
		English & Spanish	PARADA DE EMERGENCIA	ESL-44/70-ENES-10
		Spanish	PARADA DE EMERGENCIA	ESL-44/70-ES-10
		German	NOT-AUS	ESL-44/70-DE-10
		French	ARRÊT D'URGENCE	ESL-44/70-FR-10
		Italian	EMERGENZA ARRESTO	ESL-44/70-IT-10
		Russian	АВАРИЙНЫЙ ОСТАНОВ	ESL-44/70-RU-10
		Japanese	非常停止	ESL-44/70-JA-10
		Simplified Chinese (Mainland China)	紧急停止	ESL-44/70-CN-10
		Traditional Chinese (Taiwan)	緊急停止	ESL-44/70-TW-10
Portuguese	PARADA DE EMERGÊNCIA	ESL-44/70-PT-10		

EZ-LIGHT™ Illumination Logic for Emergency Stop buttons

Situation	Indication	Illumination Logic
<b>SSA-EB1xxLYR-xxxxQx or SSA-EB1xxLGR-xxxxQx</b>		
Button Armed Pin 3 open	YELLOW / SOLID or GREEN / SOLID	<ul style="list-style-type: none"> <li>Indicates button is armed</li> <li>If used, ES-FA-11AA Module is in a RESET/RUN condition (31/32 open)</li> </ul>
Button Pushed Pin 3 open or +V dc	RED / FLASH	<ul style="list-style-type: none"> <li>Indicates the button that is pushed (actuated)</li> <li>Signal on Pin 3 has no effect on a button that has been pushed (actuated)</li> </ul>
Button Armed Pin 3 = +V dc	RED / SOLID	<ul style="list-style-type: none"> <li>Indicates the machine is in an Emergency Stop or other stop condition, but that specific button has not been pushed (actuated)</li> <li>This optional signal (12 to 30 V dc) allows the user to indicate a stop condition by turning the armed indication to a RED (steady) Indication</li> </ul>
<b>SSA-EB1xxLXR-xxxxQx</b>		
Button Armed Pin 3 open	OFF	<ul style="list-style-type: none"> <li>Indicates button is armed</li> <li>If used, ES-FA-11AA Module is in a RESET/RUN condition (31/32 open)</li> </ul>
Button Pushed Pin 3 open or +V dc	RED / FLASH	<ul style="list-style-type: none"> <li>Indicates the button that is pushed (actuated)</li> <li>Signal on Pin 3 has no effect on a button that has been pushed (actuated)</li> </ul>
Button Armed Pin 3 = +V dc	RED / SOLID	<ul style="list-style-type: none"> <li>Indicates the machine is in an Emergency Stop or other stop condition, but that specific button has not been pushed (actuated)</li> <li>This optional signal (12 to 30 V dc) allows the user to indicate a stop condition by turning the armed indication to a RED (steady) Indication</li> </ul>
<b>SSA-EB1xxL-xxxxQx</b>		
Button Armed Pin 3 open	OFF	<ul style="list-style-type: none"> <li>Indicates button is armed</li> <li>If used, ES-FA-11AA Module is in a RESET/RUN condition (31/32 open)</li> </ul>
Button Pushed Pin 3 open or +V dc	RED / SOLID	<ul style="list-style-type: none"> <li>Indicates the button that is pushed (actuated)</li> <li>Signal on Pin 3 has no effect on a button that has been pushed (actuated)</li> </ul>
Button Armed Pin 3 = +V dc	RED / SOLID	<ul style="list-style-type: none"> <li>Indicates the machine is in an Emergency Stop or other stop condition, but that specific button has not been pushed (actuated)</li> <li>This optional signal (12 to 30 V dc) allows the user to indicate a stop condition by turning the armed indication to a RED (steady) Indication</li> </ul>

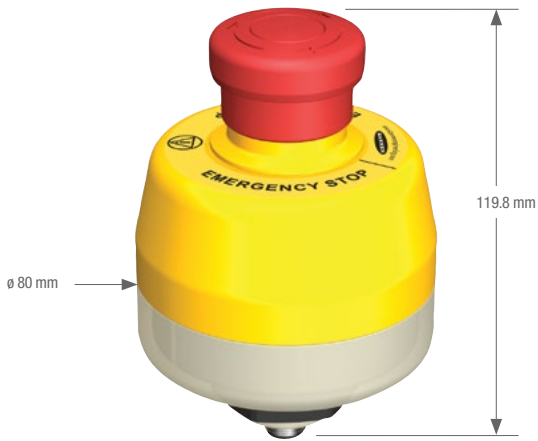

Illuminated models



Non-Illuminated models

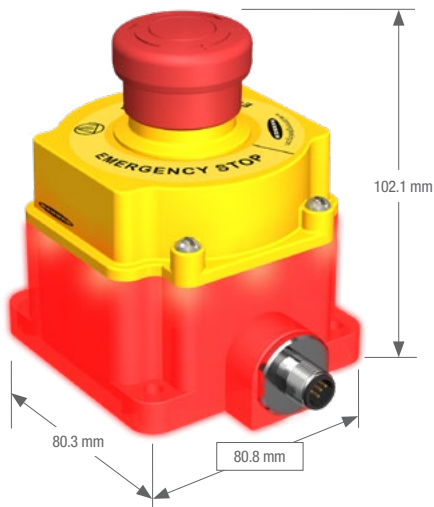

Illuminated models



Non-Illuminated models

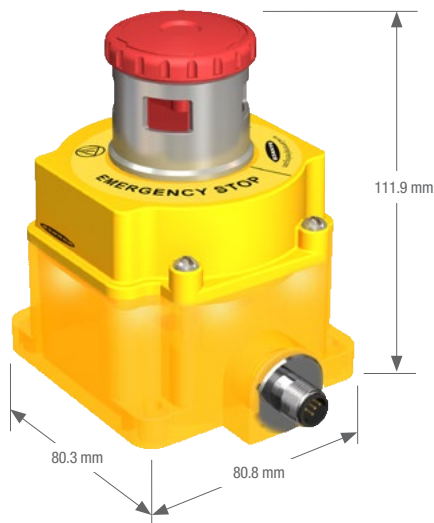

Illuminated models



Non-Illuminated models



30 mm E-Stop Push Button Specifications

Housing / Button Mounting	Polycarbonate / Polyamide Threaded base has M30 x 1.5 external threads.(M30 hardware included) <b>Max. Tightening Torque:</b> 0.56 N-m (5 in-lbf)						
Operating Temperature	-25 to +55 °C						
Environmental rating	IP65 (IEC60529)						
Operating Humidity	45% to 85% RH (no condensation)						
Insulation Resistance	100M minimum (500 V dc megger)						
Impulse Withstand Voltage	2.5 kV						
Pollution Degree	3						
Overvoltage Category	II						
Contact material / bounce*	Gold plated silver / 20 ms						
Electrical Life	100,000 operations minimum, 250,000 operations minimum at 24 V ac/dc, 100 mA						
Mechanical Life	250,000 operations						
B10d	100,000 (based on ISO13849-1(2006))						
Shock & Vibration Resistance	<b>Operating extremes:</b> 150m/s <sup>2</sup> (15G) <b>Operating extremes:</b> 10 to 500 Hz, amplitude 0.35 mm acceleration 50 m/s <sup>2</sup>						
LED Illumination	<b>Color:</b> Yellow - 590 nm, Red - 618 nm, Green - 525 nm; <b>Flash Rate:</b> 1.6 Hz at 50% duty cycle; <b>Voltage/Current:</b> 12 – 30 V dc; 120 mA at 12 V dc, 65 mA at 24 Vdc, 60 mA at 30 V dc, SSA-EB1..LGR-.. <b>(GREEN) only:</b> 12 – 30 V dc; 135 mA @ 12 V dc, 75 mA @ 24 V dc, 70 mA @ 30 V dc						
Electrical Rating	<b>Minimum load:</b> 1 mA @ 5 V ac/dc <b>SSA-EB1xx-..Q5A/Q5B:</b> 3A @ 250 V maximum <b>SSA-EB1xx-xxED1Q8:</b> 2A at 60 V ac/75 V dc maximum <b>UL Applications (UL/cUL):</b> 1.5A @ 250 V ac, 1A @ 30 V dc (pilot duty) <b>CE Applications: AC-15:</b> 1.5A @ 250 V ac, DC-13: 1A @ 30 V dc						
Rated Insulation Voltage (Ui)	250 V						
Rated Current (Ith)	3A						
Rated Operating Voltage (Ue)	See Electrical Rating	30 V	60 V ac/75 V dc	125 V	250 V		
Rated Operating Current	<b>SSA-EB1xxLxx-02ED1Q5A/Q5B</b>						
	Safety Contact (NC)	AC 50/60 Hz	Resistive Load (AC-12)	–	–	–	3A
			Inductive Load (AC-15)	–	–	3A	1.5A
		DC	Resistive Load (DC-12)	2A	–	0.4A	0.2A
			Inductive Load (DC-13)	1A	–	0.22A	0.1A
	Monitor Contacts (NO)	AC 50/60 Hz	Resistive Load (AC-12)	–	–	1.2A	0.6A
			Inductive Load (AC-15)	–	–	0.6A	0.3A
		DC	Resistive Load (DC-12)	2A	–	0.4A	0.2A
			Inductive Load (DC-13)	1A	–	0.22A	0.1A
	<b>SSA-EB1PLxx-02ECQ5A/Q5B (illuminated)</b>						
	Safety Contact (NC)	AC 50/60 Hz	Resistive Load (AC-12)	–	–	–	3A
			Inductive Load (AC-15)	–	–	3A	1.5A
		DC	Resistive Load (DC-12)	2A	–	0.4A	0.2A
			Inductive Load (DC-13)	1A	–	0.22A	0.1A
	<b>SSA-EB1Pxx-xxECQ8</b> See above for <b>SSA-EB1P-22ECQ8</b> Monitor Contacts						
	Safety Contact (NC)	AC 50/60 Hz	Resistive Load (AC-12)	–	2A	–	–
			Inductive Load (AC-15)	–	2A	–	–
		DC	Resistive Load (DC-12)	2A	0.4A	–	–
			Inductive Load (DC-13)	1A	0.22A	–	–
	Auxiliary Output (NO)	12 to 30 V dc (from pin 2)	Resistive Load (DC-12)	0.25A	–	–	–
			Inductive Load (DC-13)	0.25A	–	–	–
	<ul style="list-style-type: none"> <li>• The rated operating currents are measured at resistive/inductive load types specified in IEC 60947-5-1.</li> <li>• See "Electrical Rating" above for maximum voltage/current rating per model.</li> </ul>						
Design Standards	Compliant with EN/IEC 60497-1 / -5-1, ISO 13850, ANSI B11.19 , ANSI NFPA79, IEC 60204-1						

Certifications

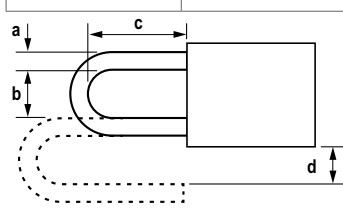

## Lockable and Illuminated E-Stop Push-Button Specifications

Housing / Button Mounting	Polycarbonate / Polyamide #10 or M5 (M5 hardware included), Max. Tightening Torque: 0.56 N•m (5 in•lbf)																																																																	
Operating Temperature	-25 to +55 °C																																																																	
Environmental rating	IP65 (IEC60529)																																																																	
Operating Humidity	45% to 85% RH (no condensation)																																																																	
Insulation Resistance	100MΩ minimum (500 V dc megger)																																																																	
Impulse Withstand Voltage	2.5kV																																																																	
Pollution Degree	3																																																																	
Overvoltage Category	II																																																																	
Contact material / bounce	Gold plated silver / 20ms																																																																	
Electrical Life	100,000 operations minimum, 250,000 operations minimum at 24 V ac/dc, 100 mA																																																																	
Mechanical Life	250,000 operations,																																																																	
B10d	100,000 (based on ISO13849-1(2006))																																																																	
Total Weight of Padlock and Hasp (SSA-EB1M..P-.. only)	1500g (3.3 lb) maximum		<b>Padlock size</b> <table border="1"> <thead> <tr> <th>a</th> <th>b</th> <th>c</th> <th>d</th> </tr> </thead> <tbody> <tr> <td>7 mm max</td> <td>19 mm min</td> <td>39 mm min</td> <td>15 mm min</td> </tr> </tbody> </table>  <p>Since various form and sizes are available, ensure applicability of padlock and hasp before use. If total weight exceeds 1500g, the switch may malfunction or fail.</p>				a	b	c	d	7 mm max	19 mm min	39 mm min	15 mm min																																																				
a	b	c	d																																																															
7 mm max	19 mm min	39 mm min	15 mm min																																																															
Shock Resistance	<b>Operating extremes:</b> 150m/s <sup>2</sup> (15G)																																																																	
Vibration Resistance	<b>Operating extremes:</b> 10 to 500 Hz, amplitude 0.35 mm acceleration 50 m/s <sup>2</sup>																																																																	
LED Illumination	<b>Color:</b> Yellow - 590 nm, Red - 618 nm, Green - 525 nm <b>Flash Rate:</b> 1.6 Hz @ 50% duty cycle <b>Voltage/Current:</b> 12 - 30 V dc; 120 mA @ 12 V dc, 65 mA @ 24 V dc, 60 mA @ 30 V dc, SSA-EB1..LGR-..(GREEN) only: 12 - 30 V dc; 135 mA @ 12 V dc, 75 mA @ 24 V dc, 70 mA @ 30 V dc																																																																	
Electrical Rating	<b>Minimum load:</b> 1 mA @ 5 V ac/dc <b>SSA-EB1xx-..Q5A/Q5B:</b> 3A @ 250 V maximum <b>SSA-EB1xx-xxED1Q8:</b> 2A @ 60 V ac/75 V dc maximum <b>UL Applications (UL/cUL):</b> 1.5A @ 250 V ac, 1A @ 30 V dc (pilot duty) <b>CE Applications: AC-15:</b> 1.5A @ 250 V ac, DC-13: 1A @ 30 V dc																																																																	
Rated Insulation Voltage (Ui)	250 V																																																																	
Rated Current (Ith)	3A																																																																	
Rated Operating Voltage (Ue)	See Electrical Rating			30 V	60 V ac/75 V dc	125 V    250 V																																																												
Rated Operating Current	<b>SSA-EB1xxLxx-02ED1Q5A/Q5B</b> <table border="1"> <thead> <tr> <th rowspan="2">Safety Contact (NC)</th> <th rowspan="2">AC 50/60 Hz</th> <th>Resistive Load (AC-12)</th> <th>—</th> <th>—</th> <th>—</th> <th>3A</th> </tr> </thead> <tbody> <tr> <th>Inductive Load (AC-15)</th> <th>—</th> <th>—</th> <th>3A</th> <th>1.5A</th> </tr> <tr> <th rowspan="2">DC</th> <th rowspan="2">DC</th> <th>Resistive Load (DC-12)</th> <th>2A</th> <th>—</th> <th>0.4A</th> <th>0.2A</th> </tr> <tr> <th>Inductive Load (DC-13)</th> <th>1A</th> <th>—</th> <th>0.22A</th> <th>0.1A</th> </tr> </tbody> </table> <b>SSA-EB1xx-xxED1Q8</b> <table border="1"> <thead> <tr> <th rowspan="2">Safety Contact (NC)</th> <th rowspan="2">AC 50/60 Hz</th> <th>Resistive Load (AC-12)</th> <th>—</th> <th>2A</th> <th>—</th> <th>—</th> </tr> </thead> <tbody> <tr> <th>Inductive Load (AC-15)</th> <th>—</th> <th>2A</th> <th>—</th> <th>—</th> </tr> <tr> <th rowspan="2">DC</th> <th rowspan="2">DC</th> <th>Resistive Load (DC-12)</th> <th>2A</th> <th>0.4A</th> <th>—</th> <th>—</th> </tr> <tr> <th>Inductive Load (DC-13)</th> <th>1A</th> <th>0.22A</th> <th>—</th> <th>—</th> </tr> <tr> <th rowspan="2">Auxiliary Output (NO)</th> <th rowspan="2">12 to 30 V dc (from pin 2)</th> <th>Resistive Load (DC-12)</th> <th>0.25A</th> <th>—</th> <th>—</th> <th>—</th> </tr> <tr> <th>Inductive Load (DC-13)</th> <th>0.25A</th> <th>—</th> <th>—</th> <th>—</th> </tr> </tbody> </table> <ul style="list-style-type: none"> <li>The rated operating currents are measured at resistive/inductive load types specified in IEC 60947-5-1.</li> <li>See "Electrical Rating" above for maximum voltage/current rating per model.</li> </ul>						Safety Contact (NC)	AC 50/60 Hz	Resistive Load (AC-12)	—	—	—	3A	Inductive Load (AC-15)	—	—	3A	1.5A	DC	DC	Resistive Load (DC-12)	2A	—	0.4A	0.2A	Inductive Load (DC-13)	1A	—	0.22A	0.1A	Safety Contact (NC)	AC 50/60 Hz	Resistive Load (AC-12)	—	2A	—	—	Inductive Load (AC-15)	—	2A	—	—	DC	DC	Resistive Load (DC-12)	2A	0.4A	—	—	Inductive Load (DC-13)	1A	0.22A	—	—	Auxiliary Output (NO)	12 to 30 V dc (from pin 2)	Resistive Load (DC-12)	0.25A	—	—	—	Inductive Load (DC-13)	0.25A	—	—	—
Safety Contact (NC)	AC 50/60 Hz	Resistive Load (AC-12)	—	—	—	3A																																																												
		Inductive Load (AC-15)	—	—	3A	1.5A																																																												
DC	DC	Resistive Load (DC-12)	2A	—	0.4A	0.2A																																																												
		Inductive Load (DC-13)	1A	—	0.22A	0.1A																																																												
Safety Contact (NC)	AC 50/60 Hz	Resistive Load (AC-12)	—	2A	—	—																																																												
		Inductive Load (AC-15)	—	2A	—	—																																																												
DC	DC	Resistive Load (DC-12)	2A	0.4A	—	—																																																												
		Inductive Load (DC-13)	1A	0.22A	—	—																																																												
Auxiliary Output (NO)	12 to 30 V dc (from pin 2)	Resistive Load (DC-12)	0.25A	—	—	—																																																												
		Inductive Load (DC-13)	0.25A	—	—	—																																																												
Design Standards	Compliant with EN/IEC 60497-1 / -5-1, ISO 13850, ANSI B11.19, ANSI NFPA79, IEC 60204-1																																																																	
Certifications	 (pending)  (pending)																																																																	

Lockable E-Stop Push-Button Specifications

Housing / Button Mounting	Polycarbonate / Polyamide #10 or M5 (M5 hardware included), Max. Tightening Torque: 0.56 N•m (5 in•lbf)
Operating Temperature	-25 to +55 °C
Environmental rating	IP65 (IEC60529)
Operating Humidity	45% to 85% RH (no condensation)
Insulation Resistance	100MΩ minimum (500 V dc megger)
Impulse Withstand Voltage	2.5kV
Pollution Degree	3
Overvoltage Category	II
Contact material / bounce	Gold plated silver / 20 ms
Electrical Life	100,000 operations minimum, 250,000 operations minimum at 24 V ac/dc, 100 mA
Mechanical Life	250,000 operations,
B10d	100,000 (based on ISO13849-1(2006))

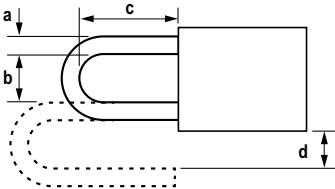
Total Weight of Padlock and Hasp (SSA-EB1M..P-.. only)	1500g (3.3 lb) maximum	<b>Padlock size</b>			
	Since various form and sizes are available, ensure applicability of padlock and hasp before use. If total weight exceeds 1500g, the switch may malfunction or fail.	<b>a</b>	<b>b</b>	<b>c</b>	<b>d</b>
		7 mm max	19 mm min	39 mm min	15 mm min
					
		Dimension "d" is 6 mm or more when attaching a padlock from the side of a switch.			

Shock Resistance	Operating extremes: 150m/s <sup>2</sup> (15G)
Vibration Resistance	Operating extremes: 10 to 500 Hz, amplitude 0.35mm acceleration 50m/s <sup>2</sup>
LED Voltage/Current	24 V ac/dc ±10%, 15mA @ 24 V ac/dc (SSA-EB1PL2-12ED1Q8 only)
Electrical Rating	Minimum load: 1 mA @ 5 V ac/dc SSA-EB1xx-..Q4 and -..Q5: 3A @ 250 V maximum SSA-EB1xx-..Q8: 2A @ 60 V AC/75 V DC maximum UL Applications (UL/cUL): 1.5A @ 250 V ac, 1A @ 30 V dc (pilot duty) CE Applications: AC-15: 1.5A @ 250 V ac, DC-13: 1A @ 30 V dc
Rated Insulation Voltage (Ui)	250 V
Rated Current (Ith)	3A

Rated Operating Voltage (Ue)	See Electrical Rating	30 V	125 V	250 V			
Rated Operating Current	Safety Contact (NC)	AC 50/60 Hz	Resistive Load (AC-12)	-	-	3A	
			Inductive Load (AC-15)	-	3A	1.5A	
		DC	Resistive Load (DC-12)	2A	0.4A	0.2A	
			Inductive Load (DC-13)	1A	0.22A	0.1A	
	Monitor Contacts (NO)	AC 50/60 Hz	Resistive Load (AC-12)	-	1.2A	0.6A	
			Inductive Load (AC-14)	-	0.6A	0.3A	
		DC	Resistive Load (DC-12)	2A	0.4A	0.2A	
			Inductive Load (DC-13)	1A	0.22A	0.1A	
	<ul style="list-style-type: none"> <li>The rated operating currents are measured at resistive/inductive load types specified in IEC 60947-5-1.</li> <li>See "Electrical Rating" above for maximum voltage/current rating per model.</li> </ul>						

Design Standards	Compliant with EN/IEC 60497-1 / -5-1, ISO 13850, ANSI B11.19, ANSI NFPA79, IEC 60204-1
------------------	--

Certifications	 (pending)  (pending)
----------------	---



# E-Stop Buttons

## 30 mm Panel Mount

- Easy to install with locking and illuminated models available
- Up to four contacts; various configurations available
- Push-to-stop, twist-to-release (standard and lockable), or pull-to-release (standard) operation per IEC60947-5-5
- Latching design complies with ISO 13850; direct (positive) opening operation per IEC 60947-5-1
- Compliant with ANSI B11.19, ANSI NFPA79, and IEC/EN 60204-1 Emergency Stop requirements
- “Safe Break Action” ensures N.C. contacts will open if the contact block is separated from the actuator

### Panel Mount E-Stop Push-Buttons

Description	Models 40 mm Button	Models 60 mm Button
2NC	SSA-EB1P-02	SSA-EB2P-02
4NC	SSA-EB1P-04	SSA-EB2P-04
1NC / 1NO	SSA-EB1P-11	SSA-EB2P-11
3NC / 1NO	SSA-EB1P-13	SSA-EB2P-13
2NC / 2NO	SSA-EB1P-22	SSA-EB2P-22

### Lockable Panel Mount E-Stop Push-Buttons

Description	Models 44 mm Button
2NC	SSA-EB1MP-02
4NC	SSA-EB1MP-04
1NC / 1NO	SSA-EB1MP-11
3NC / 1NO	SSA-EB1MP-13
2NC / 2NO	SSA-EB1MP-22

# Illuminated E-Stop Buttons



## 30 mm Panel Mount

- Easy to install with locking and illuminated models available
- Up to four contacts; various configurations available
- Push-to-stop, twist-to-release (standard and lockable), or pull-to-release (standard) operation per IEC60947-5-5
- Latching design complies with ISO 13850; direct (positive) opening operation per IEC 60947-5-1
- Compliant with ANSI B11.19, ANSI NFPA79, and IEC/EN 60204-1 Emergency Stop requirements
- “Safe Break Action” ensures N.C. contacts will open if the contact block is separated from the actuator







### Illuminated Panel Mount E-Stop Push-Buttons

Description	Models 40 mm Button
2NC, LED function per hookup	SSA-EB1PL1-02
4NC, LED function per hookup	SSA-EB1PL1-04
1NC / 1NO, LED function per hookup	SSA-EB1PL1-11
3NC / 1NO, LED function per hookup	SSA-EB1PL1-13
2NC / 2NO, LED function per hookup	SSA-EB1PL1-22
2NC / 1NO, LED function PRESS ON	SSA-EB1PL2-12

### Illuminated Lockable Panel Mount E-Stop Push-Buttons

Description	Models 44 mm Button
2NC, LED function per hookup	SSA-EB1ML1P-02
4NC, LED function per hookup	SSA-EB1ML1P-04
1NC / 1NO, LED function per hookup	SSA-EB1ML1P-11
3NC / 1NO, LED function per hookup	SSA-EB1ML1P-13
2NC / 2NO, LED function per hookup	SSA-EB1ML1P-22
2NC / 1NO, LED function PRESS ON	SSA-EB1ML2P-12

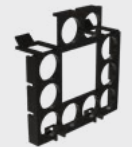
## E-Stop Legend Labels (adhesive backed label)

Product	Description	Language	Inscription	Models
	60 mm diameter (OD) Emergency Stop Legend with inscription and ISO 13850 Emergency Stop symbol (adhesive backed label).  41 mm hole for application around the base of SSA-EB1(2)P... (Pack of 10 each)	English	EMERGENCY STOP	ESL-41/60-10
		English & Spanish	PARADA DE EMERGENCIA	ESL-41/60-ENES-10
		Spanish	PARADA DE EMERGENCIA	ESL-41/60-ES-10
		German	NOT-AUS	ESL-41/60-DE-10
		French	ARRÊT D'URGENCE	ESL-41/60-FR-10
		Italian	EMERGENZA ARRESTO	ESL-41/60-IT-10
		Russian	АВАРИЙНЫЙ ОСТАНОВ	ESL-41/60-RU-10
		Japanese	非常停止	ESL-41/60-JA-10
		Simplified Chinese (Mainland China)	紧急停止	ESL-41/60-CN-10
		Traditional Chinese (Taiwan)	緊急停止	ESL-41/60-TW-10
	70 mm diameter (OD) Emergency Stop Legend with inscription and ISO 13850 Emergency Stop symbol (adhesive backed label).  44 mm hole for application around SSA-EB1M... (Pack of 10 each).	English	EMERGENCY STOP	ESL-44/70-10
		English & Spanish	PARADA DE EMERGENCIA	ESL-44/70-ENES-10
		Spanish	PARADA DE EMERGENCIA	ESL-44/70-ES-10
		German	NOT-AUS	ESL-44/70-DE-10
		French	ARRÊT D'URGENCE	ESL-44/70-FR-10
		Italian	EMERGENZA ARRESTO	ESL-44/70-IT-10
		Russian	АВАРИЙНЫЙ ОСТАНОВ	ESL-44/70-RU-10
		Japanese	非常停止	ESL-44/70-JA-10
		Simplified Chinese (Mainland China)	紧急停止	ESL-44/70-CN-10
		Traditional Chinese (Taiwan)	緊急停止	ESL-44/70-TW-10
	60 mm diameter (OD) Emergency Stop Legend with or without inscription (plastic with seal).  30 mm hole for application with SSA-EB1(2)P... or SSA-EB1M... (1 each)	English	EMERGENCY STOP	ESLP1-30/60
		N.A.	(Blank)	ESLP1-30/60-NW
	IP20 Finger-safe terminal cove			SSA-EB1-FSTC
	Standard terminal cover (supplied)			SSA-EB1-TC
	Jam nut wrench			SSA-EB1-LRW
	Jam nut twist wrench			SSA-EB1-LRTW



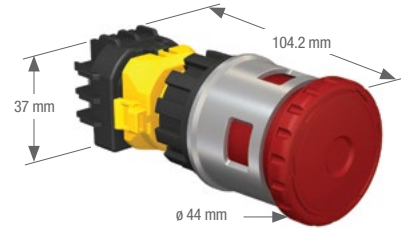
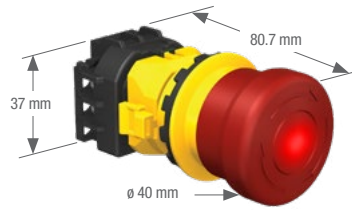
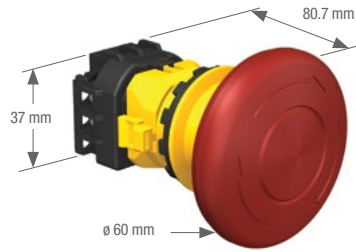

E-Stop Push Button Specifications

Button/Locking Collar	Polyamide/Aluminum
Operating Temperature	<b>Non-illuminated:</b> -25 to +60 °C <b>Illuminated:</b> -25 to +55 °C
Environmental rating	IP65 (IEC60529)
Operating Humidity	45% to 85% RH (no condensation)
Insulation Resistance	100M minimum (500 V dc megger)
Impulse Withstand Voltage	2.5kV
Pollution Degree	3
Overvoltage Category	II
Contact material / bounce*	Gold plated silver / 20 ms
Electrical Life	100,000 operations minimum, 250,000 operations minimum at 24 V ac/dc, 100 mA
Mechanical Life	250,000 operations
B10d	100,000 (based on ISO13849-1(2006))
Shock & Vibration Resistance	<b>Shock Operating extremes:</b> 150m/s <sup>2</sup> (15G) <b>Vibration Operating extremes:</b> 10 to 500 Hz, amplitude 0.35 mm acceleration 50 m/s <sup>2</sup>
Electrical Rating	<b>Minimum load:</b> 1 mA @ 5 V ac/dc <b>UL Applications:</b> 1.5A @ 250 V ac, 1A @ 30 V dc (pilot duty) <b>CE Applications:</b> AC-15: 1.5A @ 250 V ac, DC-13: 1A @ 30 V dc
Rated Insulation Voltage (Ui)	250 V
Rated Current (Ith)	3A

Rated Operating Current		Safety Contact (NC)			
		30 V	125 V	250 V	
AC 50/60 Hz	Resistive Load (AC-12)	—	—	—	
	Inductive Load (AC-15)	—	—	3A	
DC	Resistive Load (DC-12)	2A	—	0.4A	
	Inductive Load (DC-13)	1A	—	0.22A	
Monitor Contact (NO)		30 V	125 V	250 V	
		Resistive Load (AC-12)	—	1.2A	0.6A
AC 50/60 Hz	Inductive Load (AC-15)	—	0.6A	0.3A	
	Resistive Load (DC-12)	2A	0.4A	0.2A	
DC	Inductive Load (DC-13)	1A	0.22A	0.1A	

The operating current is classified according to JIS C 8201-5-1-1999 making and breaking capacities and are measured at resistive/inductive load types specified in IEC 60947-5-1. See "Electrical Rating" above for specific model and UL/CE maximum ratings.

Design Standards	Compliant with EN/IEC 60497-1 / -5-1, ISO 13850, ANSI B11.19 , ANSI NFPA79, IEC 60204-1
------------------	---

Certifications	 
----------------	---



# E-Stop Buttons

## Emergency Stop Push Buttons



- E-Stop button solution available as individual components or as kits for easy ordering.
- Higher current rating
- Modular design makes assembly and installation easy for either panel-mount or enclosure mounting
- Push-to-stop, twist-to-release operation per IEC 60497-5-5
- Compliant with ANSI B11.19, ANSI NFPA79, and IEC/EN 60204-1 Emergency Stop requirements
- Panel mount through 22 mm mounting hole

### E-Stop Push-Button Panel Mount Kits

E-Stop Button	Contacts	Legend	Enclosure	Models
 Metal-base	2 NC	Yes	No	SSA-EBM-02L
 Metal-base	1 NC & 1 NO	Yes	No	SSA-EBM-11L
 Metal-base	2 NC & 1 NO	Yes	No	SSA-EBM-12L





### E-Stop Push-Button Enclosure Kits

E-Stop Button	Contacts	Legend	Enclosure	Models*
 Metal	2 NC	Yes	Yes	SSA-EBM-02E
 Metal	1 NC & 1 NO	Yes	Yes	SSA-EBM-11E
 Metal	2 NC & 1 NO	Yes	Yes	SSA-EBM-12E

NC = Normally closed contact, NO = Normally open contact

\* The LPZP1A5 enclosure has replaced 8-L2PP-1A5 (discontinued). Please note changes in size (8-L2PP-1A5: 72mm x 85mm) and mounting hole location (8-L2PP-1A5: 49mm x 54mm).

E-Stop Push-Button Components

Product	Description	Models
	22.5 mm metal button (8-LM2T-AU120 mounting adapter sold separately)	8-LM2T-B6644*
	Metal mounting adapter (for metal button)	8-LM2T-AU120
	Normally closed (NC) positively driven contact element	8-LM2T-C01**
	Normally open (NO) auxiliary contact element	8-LM2T-C10
	One 22 mm button enclosure, maximum of three contact blocks, wire entry through three sides (M16, M20 or M25) or the bottom (M16)	LPZP1A5***

\* Twist to release, mechanical latching ISO 13850 (EN 418) compliant. Diameter 40 mm (without mounting adapter).

\*\* Direct (positive) opening operation per IEC/EN 60947-5-1.

\*\*\* The LPZP1A5 enclosure has replaced 8-L2PP-1A5 (discontinued). Please note changes in size (8-L2PP-1A5: 72mm x 85mm) and mounting hole location (8-L2PP-1A5: 49mm x 54mm).



## E-Stop Legend Labels (adhesive backed label)

Product	Description	Language	Inscription	Models <sup>†</sup>
	60 mm diameter, non-adhesive plastic legend with "Emergency Stop" inscription	English	EMERGENCY STOP	8-LM2T-AU115 <sup>†</sup>
	60 mm diameter (OD) Emergency Stop Legend with inscription and ISO 13850 Emergency Stop symbol (adhesive backed label).  41 mm hole for application around the base of <b>SSA-EB1(2)P...</b> (Pack of 10 each)	English	EMERGENCY STOP	ESL-41/60-10
		English & Spanish	PARADA DE EMERGENCIA	ESL-41/60-ENES-10
		Spanish	PARADA DE EMERGENCIA	ESL-41/60-ES-10
		German	NOT-AUS	ESL-41/60-DE-10
		French	ARRÊT D'URGENCE	ESL-41/60-FR-10
		Italian	EMERGENZA ARRESTO	ESL-41/60-IT-10
		Russian	АВАРИЙНЫЙ ОСТАНОВ	ESL-41/60-RU-10
		Japanese	非常停止	ESL-41/60-JA-10
		Simplified Chinese (Mainland China)	紧急停止	ESL-41/60-CN-10
		Traditional Chinese (Taiwan)	緊急停止	ESL-41/60-TW-10
Portuguese	PARADA DE EMERGÊNCIA	ESL-41/60-PT-10		

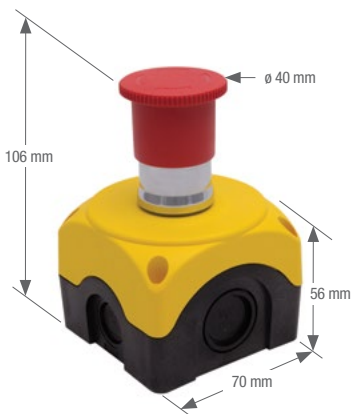

<sup>†</sup> Additional E-Stop background labels are available (see p/n 121976).



E-Stop Push-Button Specifications

Mechanical Life	300,000 operations
Operating Force	0.8 kg
Mounting Adapter	<b>Metal button:</b> The adapter is fixed to the mounting surface by means of incorporated screws (Tmax = 0.8 Nm)
Construction	<b>Plastic parts:</b> Polyamide and polycarbonate <b>Metal parts:</b> Aluminum and zinc alloy
Environmental Rating	IP65
Operating Temperature	-25 to +60 °C
Certifications	  Compliant with EN/IEC 60947-1; -5-1







Contact Specifications

Mechanical Life	300,000 operations																																								
European Rating	<b>Utilization categories:</b> AC15 and DC13 U <sub>i</sub> = 690 V ac I <sub>th</sub> = 10A UL designation = A 600 Q600																																								
Rated Operating Voltage (U <sub>e</sub> ) and Current	<p><b>IEC operational power in AC15</b></p> <table border="1"> <tr> <td>V</td> <td>12</td> <td>24</td> <td>48</td> <td>120</td> <td>240</td> <td>400</td> <td>480</td> <td>500</td> <td>600</td> </tr> <tr> <td>A</td> <td>6</td> <td>6</td> <td>6</td> <td>6</td> <td>3</td> <td>1.9</td> <td>1.5</td> <td>1.4</td> <td>1.2</td> </tr> </table> <p><b>IEC operational power in DC13</b></p> <table border="1"> <tr> <td>V</td> <td>12</td> <td>14</td> <td>48</td> <td>125</td> <td>250</td> <td>440</td> <td>500</td> <td>600</td> <td></td> </tr> <tr> <td>A</td> <td>3</td> <td>3</td> <td>1.5</td> <td>0.55</td> <td>0.27</td> <td>0.15</td> <td>0.13</td> <td>0.1</td> <td></td> </tr> </table>	V	12	24	48	120	240	400	480	500	600	A	6	6	6	6	3	1.9	1.5	1.4	1.2	V	12	14	48	125	250	440	500	600		A	3	3	1.5	0.55	0.27	0.15	0.13	0.1	
V	12	24	48	120	240	400	480	500	600																																
A	6	6	6	6	3	1.9	1.5	1.4	1.2																																
V	12	14	48	125	250	440	500	600																																	
A	3	3	1.5	0.55	0.27	0.15	0.13	0.1																																	
Mechanical Life	1,000,000 operations																																								
B10d	8-LM2T-Cxx 1,000,000																																								
Connections	(1 or 2) 12 AWG (2.5 mm <sup>2</sup> ) maximum wire size, tightening torque: Tmax = 1 Nm																																								
Construction	Polyamide and polycarbonate																																								
Environmental Rating	IP20																																								
Operating Temperature	-25 to +60 °C																																								
Application Notes	Normally Closed safety contacts (8-LM2T-C01) should only be attached to the left and right snap-on positions of the mounting adaptor. A maximum of two contact elements can be used in a single snap-on position.																																								
Certifications	  Compliant with EN/IEC 60947-1; -5-1																																								



## Emergency Stop & Stop Control

Rope pull emergency stop switches, when used with steel wire rope, provide emergency stop actuation for conveyors and large machinery.

Series	Description	Application	Dimensions H x W x D	Actuation	Housing Material
	<b>RP-RM83</b> Rated for use in harsh environments and outdoors, and activates if the rope is pulled, becomes loose or breaks. page 622	Emergency Stop	H (varies by model) 90 x 53 mm	Latch	Metal
	<b>RP-LS42</b> Rugged plastic housing to withstand harsh environments and is available with an E-stop button with manual reset. page 623	Emergency Stop	H (varies by model) 42 x 45 mm	Latch	Plastic
	<b>RP-QM72</b> Heavy-duty switch housing withstands harsh environments. page 624	Stop-Control	<b>RP-QM72:</b> 142 x 69 x 82 mm <b>RP-QMT72:</b> 181 x 69 x 82 mm	Latch	Metal
	<b>RP-LM40</b> Heavy-duty switch housing withstands harsh environments. page 625	Stop-Control	<b>RP-LM40D-6:</b> 124.5 x 40 x 37.5 mm <b>RP-LM40D-6L:</b> 147.5 x 40 x 37.5 mm	Trip & Latch	Metal
	<b>RP-QM90</b> Heavy-duty switch housing withstands harsh environments. page 626	Stop-Control	137 x 206 x 90 mm	Latch	Metal
	<b>ED1G</b> Handheld grip-style switch is typically used for manual control of machine functions, including visual observations, minor adjustments, troubleshooting, calibration and more. page 636	Stop-Control	260 x 46 x 58 mm		Plastic









# RP-RM83

## Rope Pull E-Stop Device



- Heavy-duty housing rated to IP67 for use in harsh environments and outdoors, and activates if the rope is pulled, becomes loose or breaks
- Additional solid-state auxiliary output for remote tension monitoring
- Tension indicators
- Operates in a range up to 75 m
- Design meets positive opening requirements for rope pull switches (IEC 60947-5-1)
- Complies with ANSI NFPA 79, ANSI B11.19, IEC 60204-1, EN 13850 and EN ISO 60947-5-5 for Emergency Stop applications



### RP-RM83 Series E-Stop and Stop Control Device

Max. Rope Length	Safety Contacts	Auxiliary Contacts	Action	Contact State				Model*
				Safety 1	Safety 2	Auxiliary 1	Auxiliary 2	
38 m	2 NC in 	2 NO in 	 	Safety 1	Safety 2	Auxiliary 1	Auxiliary 2	RP-RM83F-38LTE
				open	open	closed	closed	RP-RM83F-38LRE
75 m	2 NC in 	2 NO in 	 	Safety 1	Safety 2	Auxiliary 1	Auxiliary 2	RP-RM83F-75LTE
				open	open	closed	closed	RP-RM83F-75LRE
				open	open	closed	closed	RP-RM83F-75LT
				open	open	closed	closed	RP-RM83F-75LR

\* Models with T suffix have a Built-in Turnbuckle for rope  
Models with R suffix have a Ring connection to rope  
Models with E suffix have an auxiliary status output



For more specifications see page 632.

 Run Position	 Cable Pulled	 Cable Break	NC = Normally Closed Contact, NO = Normally Open Contact
<p>RP-RM83 rope pulls comply with IEC 60947-5-1 Positive Opening requirements. See data sheet or Contact Configuration and Switching Diagrams for more information/clarification.(page 633) For dimensions see page 627.</p>			



# RP-LS42

## Rope Pull E-Stop Device



- Rugged plastic housing to withstand harsh environments and has an E-stop button model with manual reset.
- Tension indicators
- Operates in ranges up to 75 m
- Switch activates if the rope is pulled, becomes loose or breaks
- Design meets positive opening requirements for rope pull switches (IEC 60947-5-1)
- Complies with ANSI NFPA 79, ANSI B11.19, IEC 60204-1, EN 13850 and EN ISO 60947-5-5 for Emergency Stop applications

### RP-LS42 Series E-Stop and Stop Control Device

Max. Rope Length	Safety Contacts	Auxiliary Contacts	Action	Contact State				Model*
				Safety		Auxiliary		
				1	2	1	2	
25 m	2 NC in	2 NO in	 	open	open	closed	closed	RP-LS42F-25L
				open	open	closed	closed	RP-LS42F-25LE
				open	open	closed	closed	RP-LS42F-25LF
37.5 m	2 NC in	2 NO in	 	open	open	closed	closed	RP-LS42F-38L
				open	open	closed	closed	RP-LS42F-38LE
				open	open	closed	closed	RP-LS42F-38LF
75 m	2 NC in	2 NO in	 	open	open	closed	closed	RP-LS42F-75L
				open	open	closed	closed	RP-LS42F-75LE
				open	open	closed	closed	RP-LS42F-75LF



- Models with LF suffix have a Built-in Turnbuckle for rope
- Models with L suffix have a Ring connection to rope
- Models with LE suffix have a Built-in Turnbuckle for rope and an E-stop button

For more specifications see page 632

	Run Position		Cable Pulled		Cable Break	NC = Normally Closed Contact, NO = Normally Open Contact
--	--------------	--	--------------	--	-------------	--

RP-RM83 rope pulls comply with IEC 60947-5-1 Positive Opening requirements.  
See data sheet or Contact Configuration and Switching Diagrams for more information/clarification.(page 633)  
For dimensions see page 627.











# RP-QM72/QMT72

## Rope Pull Switches



- Heavy-duty switch housing withstands harsh environments and have a max. rope pull length of 6, 12 or 20 m depending on model.
- Switches activate if the rope is pulled, becomes loose or breaks
- Manual reset (Latch) design if the rope is pulled
- Rugged metal housing with protective earth terminal (IEC 60947-1)
- Comply with ANSI NFPA 79 and IEC 60204-1 for Stop Control applications

### RP-QM72/QMT72 Series Stop Control Device

Max. Rope Length	Safety Contacts	Auxiliary Contacts	Action	Contact State				Model
6 m				Safety		Auxiliary		RP-QM72D-6L
12 m	2 NC in 	—		1	1	1	1	RP-QM72D-12L
20 m				open	open	closed	closed	RP-QMT72D-20L
				Safety		Auxiliary		
12 m	4 NC in 	—		1	2	1	2	RP-QMT72F-12L
				open	open	closed	closed	
				closed	closed	open	open	
12 m	2 NC in 	1 NO in 		Safety		Auxiliary		RP-QMT72E-12L
				1	2	1	2	
				open	open	closed	closed	
				closed	closed	open	open	



For more specifications see page 632.



Run Position



Cable Pulled



Cable Break

NC = Normally Closed Contact, NO = Normally Open Contact

RP-RM83 rope pulls comply with IEC 60947-5-1 Positive Opening requirements.

See data sheet or Contact Configuration and Switching Diagrams for more information/clarification.(page 633)

For dimensions see page 627.



# RP-LM40

## Rope Pull Switches



- Heavy-duty switch housing withstands harsh environments
- Manual reset (Latch) design after the rope is pulled and Auto Reset (Trip) models
- Rugged metal housing with protective earth terminal (IEC 60947-1)
- Switches activate if the rope is pulled, becomes loose or breaks
- Design meets positive opening requirements for rope pull switches (IEC 60947-5-1)
- Comply with ANSI NFPA 79 and IEC 60204-1 for Stop Control applications



### RP-LM40 Series Stop Control Device

Max. Rope Length	Safety Contacts	Auxiliary Contacts	Action	Contact State				Model*
				Safety		Auxiliary		
				1	2	1	2	
6 m	2 NC in 	—	 	open	open	closed	closed	RP-LM40D-6
				closed	closed	open	open	RP-LM40D-6L



\* Models with 6 suffix use Trip actuation  
 Models with 6L suffix use Latch actuation (typical)

For more specifications see page 632

	Run Position		Cable Pulled		Cable Break	NC = Normally Closed Contact, NO = Normally Open Contact
--	--------------	---	--------------	---	-------------	--

RP-RM83 rope pulls comply with IEC 60947-5-1 Positive Opening requirements.  
 See data sheet or Contact Configuration and Switching Diagrams for more information/clarification.(page 633)  
 For dimensions see page 627.

# RP-QM90

## Rope Pull Switches



- Heavy-duty switch housing withstands harsh environments
- Manual reset (Latch) design after the rope is pulled
- Rugged metal housing with protective earth terminal (IEC 60947-1)
- Switch activates if the rope is pulled, becomes loose or breaks
- Operates in a range up to 100 m
- Design meets positive opening requirements for rope pull switches (IEC 60947-5-1)

### RP-QM90 Series Stop Control Device



Max. Rope Length	Safety Contacts	Auxiliary Contacts	Action	Contact State				Model
				Safety		Auxiliary		
				1	2	1	2	
100 m (50 m each side)	2 NC in	2 NO in	 	open	open	closed	closed	RP-QM90F-100L
				open	open	closed	closed	

For more specifications see page 632.



Run Position



Cable Pulled



Cable Break

NC = Normally Closed Contact, NO = Normally Open Contact

RP-RM83 rope pulls comply with IEC 60947-5-1 Positive Opening requirements.

See data sheet or Contact Configuration and Switching Diagrams for more information/clarification.(page 633)

For dimensions see page 627.



RP-RM83F-75LT.. and RP-RM83F-38LT.. Models



RP-RM83F-75LR.. and RP-RM83F-38LR.. Models



RP-LS42F-...L Model

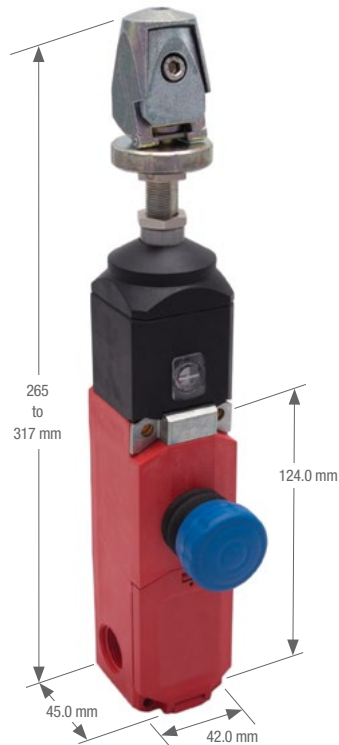

RP-LS42F-...LF Model



RP-LS42F-...LE Model (with E-Stop Button)

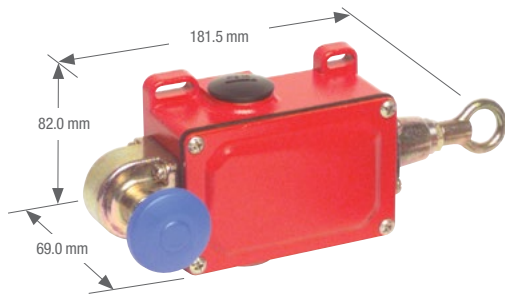

RP-QMT72 Models

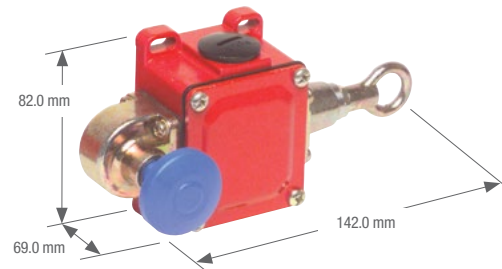

RP-QM72 Models

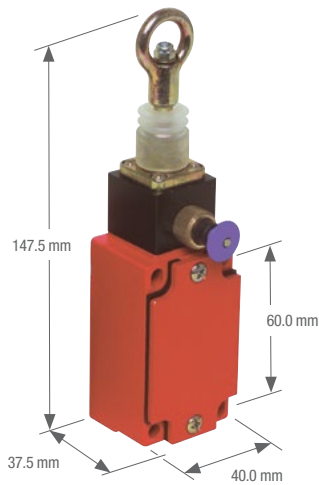

RP-LM40D-6L Model

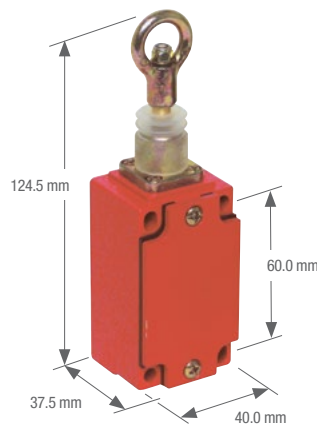

RP-LM40D-6 Model

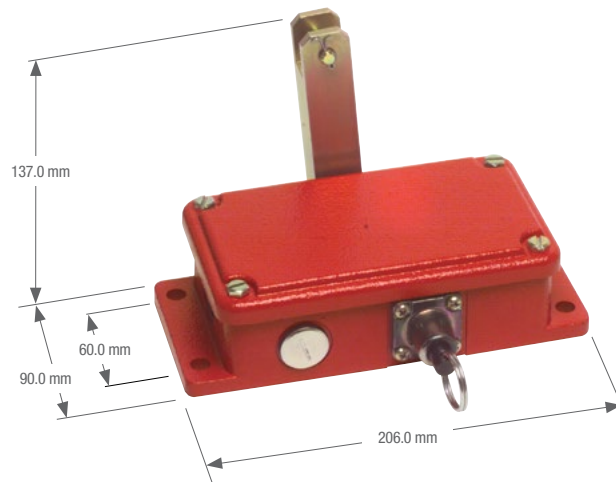



RP-QM90 Model

Components for Wire Rope Assembly

	Models	Package Quantity	Description	Used With	
Wire Ropes		RPA-C1-10	10 m	2 mm steel wire rope with 0.5 mm red PVC jacket (unterminated)	• RP-LM40 models
		RPA-C1-20	20 m		
		RPA-C1-100	100 m		
		RPA-C2-10	10 m	3 mm steel wire rope with 0.25 mm red PVC jacket (unterminated)	• RP-LS42 models • RP-QM72/QMT72 models • RP-RM83 models
		RPA-C2-20	20 m		
		RPA-C2-40	40 m		
		RPA-C2-50	50 m		
		RPA-C2-80	80 m		
		RPA-C3-20	20 m	4 mm steel wire rope with 0.5 mm red PVC jacket (unterminated)	• RP-QM90 models
		RPA-C3-100	100 m		
Thimbles		RPA-T1-4	4 pcs	Thimble for 2 mm wire rope	• RP-LM40 models
		RPA-T2-4	4 pcs	Thimble for 3 mm wire rope	• RP-LS42 models • RP-QM72/QMT72 models • RP-RM83 models
		RPA-T3-4	4 pcs	Thimble for 4 mm wire rope	• RP-QM90 models
Clamps		RPA-CC1-4	4 pcs	Clamp for 2 mm wire rope	• RP-LM40 models
		RPA-CC2-4	4 pcs	Clamp for 3 mm wire rope	• RP-LS42 models • RP-QM72/QMT72 models • RP-RM83 models
		RPA-CC3-4	4 pcs	Clamp for 4 mm wire rope	• RP-QM90 models
Turnbuckles		RPA-TA1-1	1 pc	#4 Turnbuckle	• RP-LM40 models • RP-LS42 models • RP-QM72/QMT72 models • RP-RM83 models
		RPA-TA2-1	1 pc	#5 Turnbuckle	• RP-QM90 models
Eye Bolts		RPA-EB1-1	1 pc	1/4" - 20 Eye bolt (3" bolt shaft)	• RP-LM40 models • RP-LS42 models • RP-QM72/QMT72 models • RP-RM83 models
		RPA-EB2-1	1 pc	5/16" - 18 Eye bolt (3" bolt shaft)	• RP-QM90 models
Pulleys		1 pc	RPA-P1-1 Pulley for in-line use	RPA-DP1-1 Pulley for corner turns (< 180°)	• RP-LM40 models • RP-LS42 models • RP-QM72/QMT72 models • RP-RM83 models • RP-QM90 models
					
Tensioning Springs		RPA-S1-1	1 pc	Tensioning Spring #1	• RP-QM90 models
		RPA-S2-1	1 pc	Tensioning Spring #2	• RP-QM90 models
		RPA-S3-1	1 pc	Tensioning Spring #3	• RP-LS42 models (75 m) • RP-RM83 models (75 m)
		RPA-S5-1	1 pc	Tensioning Spring #5	• RP-RM83 models (38 m)
		RPA-S4-1	1 pc	Tensioning spring assembly with built-in eye bolt, cable thimble, clamp, tensioning and overload protection	• RP-LS42 models (75 m) • RP-RM83 models (75 m)
		RPA-S6-1	1 pc		• RP-RM83 models (38 m) • RP-LS42 models (25 & 38 m)
Terminal Cover	SI-LS42-COVER		Replacement terminal cover	• RP-LS42 models	

Continued on next page

## Components for Wire Rope Assembly (cont'd)



	Models	Package Quantity	Description	Used With	
EZ-LIGHT®		SI-K30LGRX7P	1 pc	Green/Red indication	<ul style="list-style-type: none"> <li>• RP-LM40</li> <li>• RP-LS42F</li> <li>• RP-QM90F</li> <li>• RP-QM( T)72</li> <li>• RP-RM83F</li> <li>• SI-LS31</li> <li>• SI-LS100</li> <li>• SI-QS90</li> <li>• SI-LM40</li> <li>• SI-LS42SI-QM100</li> </ul>
		SI-K30LYRX7P	1 pc	Yellow/Red indication (used with RP-RM83F-xxLTE/-xxLRE with tension alarm)	
		SI-K30LRXX7P	1 pc	Red indication	
Indicator Lamps		SI-PL3T-R	1 pc	Red with M20 x 1.5 (24 V ac/dc)	<ul style="list-style-type: none"> <li>• RP-LS42</li> <li>• RP-QM72/QMT72</li> <li>• RP-RM83</li> <li>• RP-QM90</li> </ul>
		SI-PL3A-R	1 pc	Red with M20 x 1.5 (120 V ac)	
		SI-PL3T-G	1 pc	Green with M20 x 1.5 (24 V ac/dc)	
		SI-PL3A-G	1 pc	Green with M20 x 1.5 (120 V ac)	
Cable Gland		SI-QS-CGM20	1 pc	For 5 to 12 mm diameter cable	<ul style="list-style-type: none"> <li>• SI-QS90 Safety Interlock Switches</li> <li>• SI-LS100 Safety Interlock Switches</li> <li>• SI-LS31 Safety Interlock Switches</li> <li>• SI-LS42 Safety Interlock Switches</li> <li>• RP-LS42 Rope Pull Switches</li> </ul>
Conduit Adaptor		SI-QS-M20	1 pc	M20 x 1.5 to ½ in-14 NPT	<ul style="list-style-type: none"> <li>• SI-QS90 Safety Interlock Switches</li> <li>• SI-LS100 Safety Interlock Switches</li> <li>• SI-LS31 Safety Interlock Switches</li> <li>• SI-LS42 Safety Interlock Switches</li> <li>• RP-LS42 Rope Pull Switches</li> </ul>



Wire Rope Assembly Kits (Tensioning Springs ordered separately)

3 mm Rope (Length)	Thimbles (Each)	Clamps (Each)	Eye Bolts (Each)	In-Line Pulleys (Each)	Turnbuckle (Each)	Kit Model
0.5 m	2	2	—	—	—	RPAK-C2SBP-1
10 m	4	4	3	—	—	RPAK-CH2-10
	4	4	3	3	—	RPAK-CHP2-10
	4	4	3	—	1	RPAK-CH2-10-TA
	4	4	3	3	1	RPAK-CHP2-10-TA
20 m	4	4	6	—	—	RPAK-CH2-20
	4	4	6	6	—	RPAK-CHP2-20
	4	4	6	—	1	RPAK-CH2-20-TA
	4	4	6	6	1	RPAK-CHP2-20-TA
40 m	4	4	11	—	—	RPAK-CH2-40
	4	4	11	11	—	RPAK-CHP2-40
	4	4	11	—	1	RPAK-CH2-40-TA
	4	4	11	11	1	RPAK-CHP2-40-TA
50 m	4	4	14	—	—	RPAK-CH2-50
	4	4	14	14	—	RPAK-CHP2-50
	4	4	14	—	1	RPAK-CH2-50-TA
	4	4	14	14	1	RPAK-CHP2-50-TA
80 m	4	4	21	—	—	RPAK-CH2-80
	4	4	21	21	—	RPAK-CHP2-80
	4	4	21	—	1	RPAK-CH2-80-TA
	4	4	21	21	1	RPAK-CHP2-80-TA

## Rope Pull Switches Specifications

Contact Rating	10A @ 24 V ac, 10A @ 110 V ac, 6A @ 230 V ac, 6A @ 24 V dc 2.5 kV max. transient tolerance NEMA A300 P300																							
Monitoring Solid-State Output Rating	<b>Rated operational voltage:</b> Ue= 10 to 30 V dc <b>Rated operational current:</b> Ie= 50 mA <b>Utilization category:</b> DC13 Protected against reverse polarity and short circuit.																							
European Rating	<b>Utilization categories:</b> AC15 and DC13 Ui= 500V ac, I <sub>th</sub> = 10A <b>Rated Surge Capacity:</b> 2.5 kV (RP-RM83 only)	<b>RP-RM83 models (40-60 Hz)</b> <table border="1"> <thead> <tr> <th>Ue V</th> <th>Ie/AC-15 A</th> <th>Ie/DC-13 A</th> </tr> </thead> <tbody> <tr> <td>120</td> <td>6</td> <td>0.55</td> </tr> <tr> <td>240</td> <td>3</td> <td>0.27</td> </tr> </tbody> </table>	Ue V	Ie/AC-15 A	Ie/DC-13 A	120	6	0.55	240	3	0.27	<b>All others (40-60 Hz)</b> <table border="1"> <thead> <tr> <th>Ue V</th> <th>Ie/AC-15 A</th> <th>Ie/DC-13 A</th> </tr> </thead> <tbody> <tr> <td>24</td> <td>10</td> <td>6</td> </tr> <tr> <td>110</td> <td>10</td> <td>1</td> </tr> <tr> <td>230</td> <td>6</td> <td>0.4</td> </tr> </tbody> </table>	Ue V	Ie/AC-15 A	Ie/DC-13 A	24	10	6	110	10	1	230	6	0.4
Ue V	Ie/AC-15 A	Ie/DC-13 A																						
120	6	0.55																						
240	3	0.27																						
Ue V	Ie/AC-15 A	Ie/DC-13 A																						
24	10	6																						
110	10	1																						
230	6	0.4																						
Contact Material	Silver-nickel alloy																							
Maximum Switching Speed	RP-RM83 models: 20 operations per minute <b>All others:</b> 50 operations per minute																							
Recommended Rope Size	<b>40 mm models:</b> 2 mm diameter steel rope <b>42 &amp; 72 mm models:</b> 3 mm diameter steel rope <b>83 mm models:</b> 2-5 mm diameter steel rope (3 mm recommended) <b>90 mm models:</b> 4 mm diameter steel rope																							
Maximum Rope Pull Length	<b>RP-LM40D-6/6L and RP-QM72D-6L:</b> 6 m <b>RP-LS42F-75L/75LE/75LF:</b> 75 m <b>RP-LS42F-38L/38LE/38LF:</b> 37.5 m <b>RP-LS42F-25L/25LE/25LF:</b> 25 m <b>RP-QM72D-12L:</b> 12 m <b>RP-QMT72D-20L:</b> 20 m <b>RP-QMT72E-12L and RP-QMT72F-12L:</b> 12 m <b>RP-RM83F-75LTE/LT/LRE/LR:</b> 75 m <b>RP-RM83F-38LTE/LT/LR/LRE:</b> 38 m <b>RP-QM90F-100L:</b> 100 mm; equal lengths up to 50 m on either side of switch																							
Short Circuit Protection	10 amp Slow Blow, 15 amp Fast Blow. Recommended external fusing or overload protection.																							
Mechanical Life	<b>RP-RM83:</b> 100,000 operations <b>All others:</b> 1 million operations																							
Wire Connections	Screw terminals with pressure plates accept the following wire sizes – <b>Stranded and solid:</b> 20 AWG (0.5 mm <sup>2</sup> ) to 16 AWG (1.5 mm <sup>2</sup> ) for one wire <b>Stranded:</b> 20 AWG (0.5 mm <sup>2</sup> ) to 18 AWG (1.0 mm <sup>2</sup> ) for two wires																							
Cable Entry	M20 x 1.5 threaded entrance Adapter supplied to convert M20 x 1.5 to ½" - 14 NPT threaded entrance																							
Construction	<b>RP-LS42F-..L/..LE/..LF:</b> High-impact thermoplastic housing; zinc die-cast actuator <b>All others:</b> Aluminum alloy die cast																							
Environmental Rating	<b>RP-LS42F and RP-RM83F models:</b> NEMA 4; IEC IP67 <b>All other models:</b> NEMA 4; IP65																							
Operating Temperature	<b>RP-LS42F-..L/..LE/..LF:</b> -25 to +70 °C <b>All other models:</b> -30 to +80 °C																							
Weight	<b>RP-LM40D-6:</b> 0.22 Kg <b>RP-LM40D-6L:</b> 0.26 Kg <b>RP-LS42F-..L:</b> 0.48 Kg <b>RP-LS42F-..LE and RP-LS42F-..LF:</b> 0.65 Kg <b>RP-QM72D-6L:</b> 0.49 Kg <b>RP-QM72D-12L:</b> 0.52 Kg <b>RP-QMT72D-20L, RP-QMT72E-12L and RP-QMT72F-12L:</b> 0.64 Kg <b>RP-QM90F-100L:</b> 3.8 Kg <b>RP-RM83F-75LT and RP-RM83F-75LTE:</b> 1 Kg <b>RP-RM83F-75LR and RP-RM83F-75LRE:</b> 0.77 Kg <b>RP-RM83F-38LT and RP83FLT8:</b> 1 Kg <b>RP-RM83F-38LR and RP-RM83F-38LRE:</b> 0.77 Kg																							
Certifications	   (RP-RM83 and RP-LS42 only)																							
Contact Configurations and Switching Diagrams	<b>RP-LM40 models:</b> SD11, SD12 (page 634) <b>RP-LS42 models:</b> SD05 (page 633) <b>RP-QM72/QMT72 models:</b> SD06, SD07, SD08, SD09 & SD10 (page 634) <b>RP-RM83 models:</b> SD01, SD02, SD03 & SD04 (page 633) <b>RP-QM90 models:</b> SD13 (page 635)																							

SD01 - RP-RM83F-75LTE/LRE Series

SD02 - RP-RM83F-38LTE/LRE Series

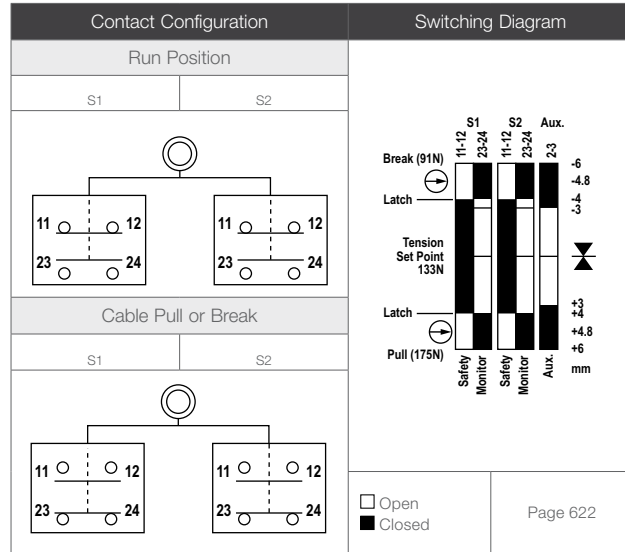
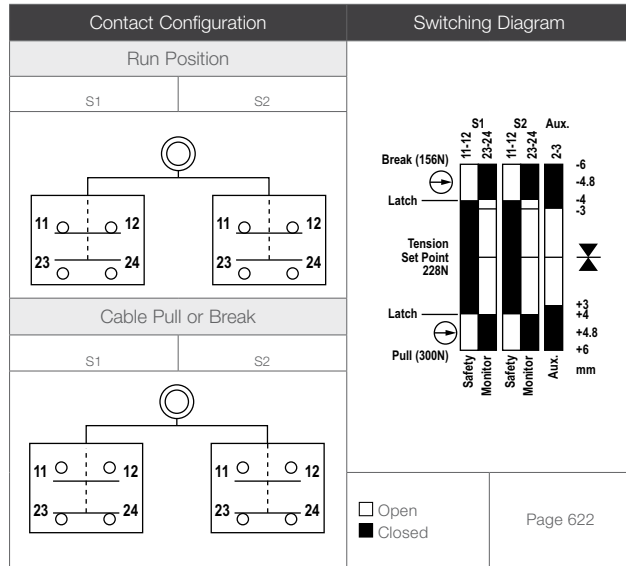

SD03 - RP-RM83-75LT/LR Series

SD04 - RP-RM83-38LT/LR Series

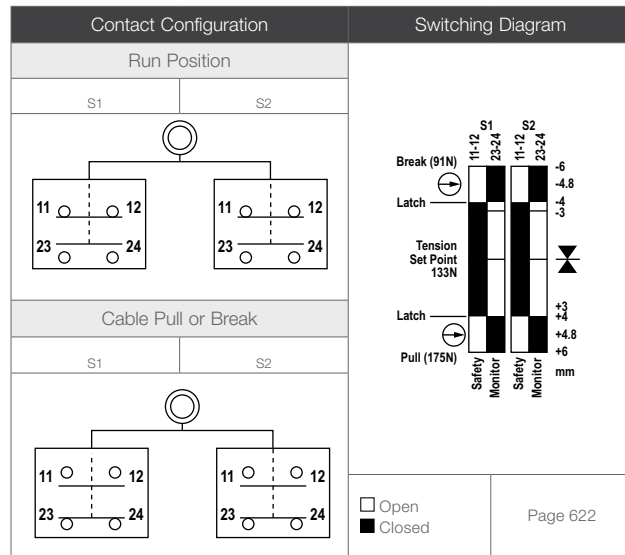
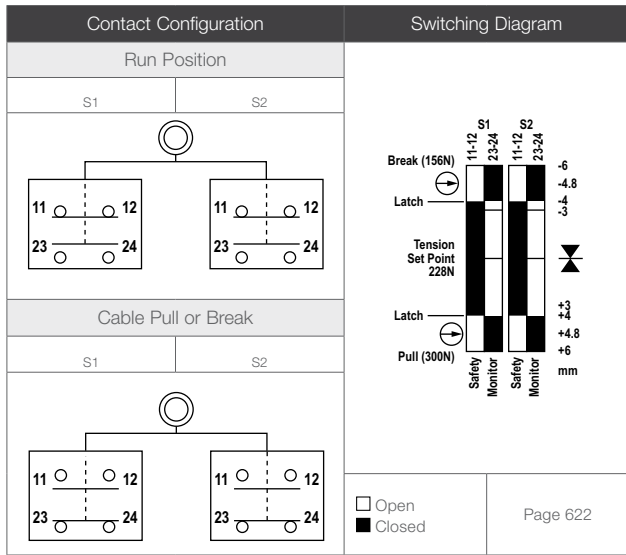

SD05 - RP-LS42F-25/38/75xx Series

SD06 - RP-QM72D-6L Series

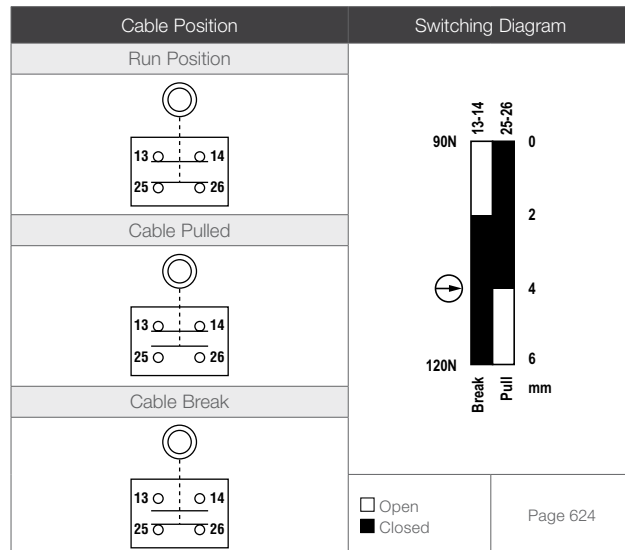
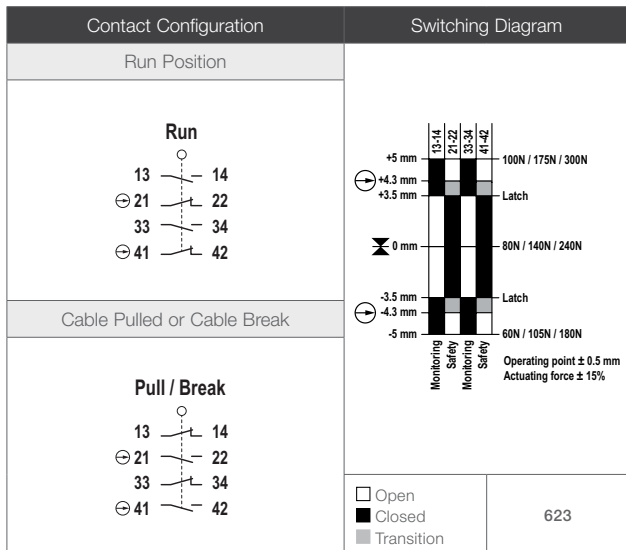

SD07 - RP-QM72D-12L Series

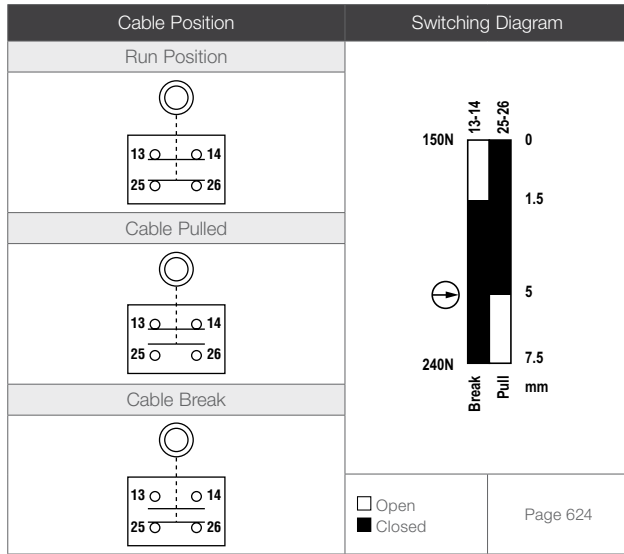

SD08 - RP-QMT72D-20L Series

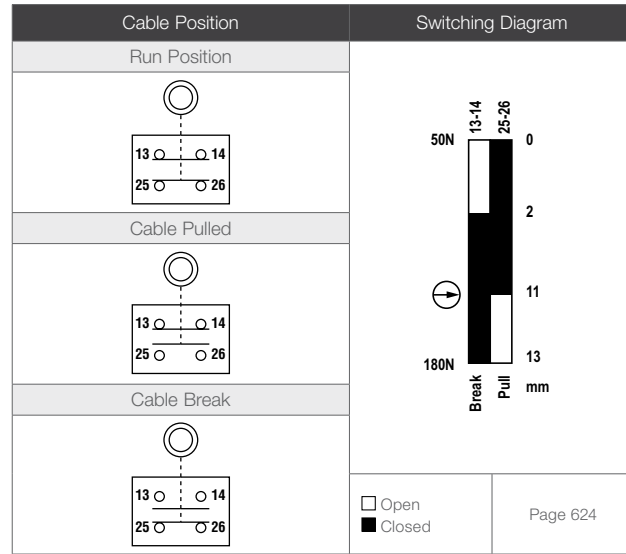

SD09 - RP-QMT72F-12L Series

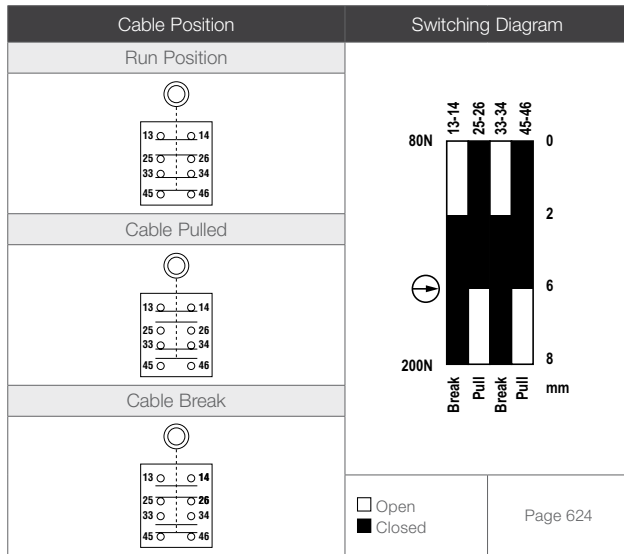

SD10 - RP-QMT72E-12L Series

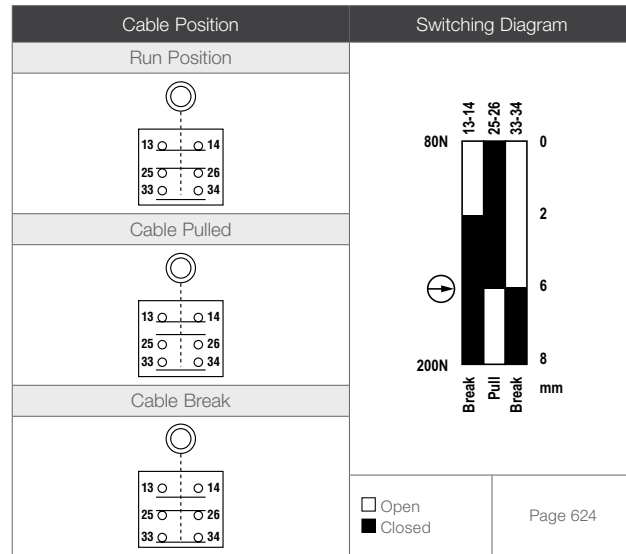

SD11 - RP-LM40D-6 Series

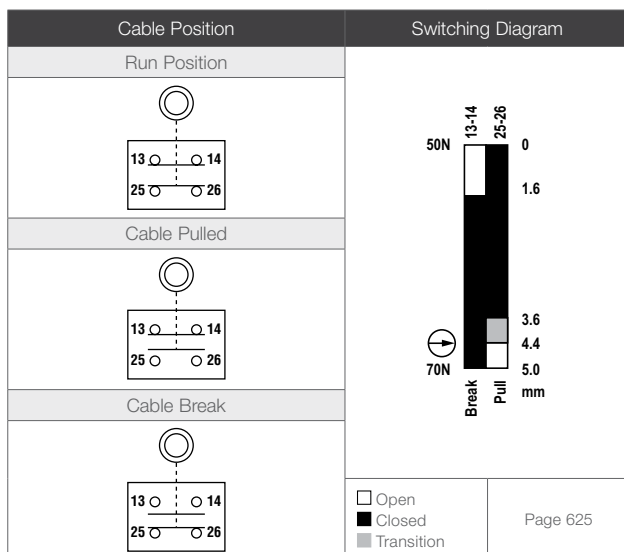

SD12 - RP-LM40D-6L Series

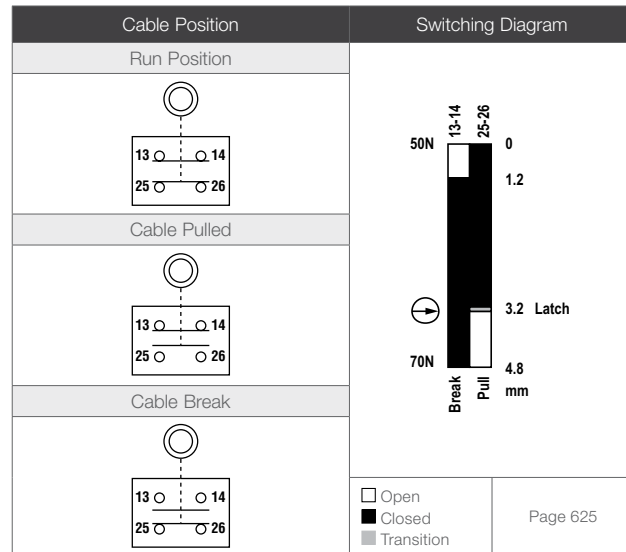

SD13 - RP-QM90F-100L Series

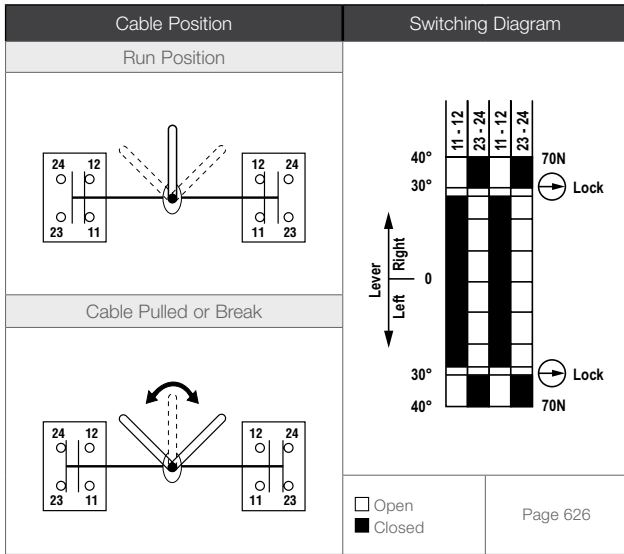

# ED1G

## Enabling Devices



- Handheld grip-style switch is typically used for manual control of machine functions, including visual observations, minor adjustments, troubleshooting, calibration and more
- Provides the three-position functionality (OFF-ON-OFF) required for manual control of a machine, including enabling and hold-to-run applications
- Ergonomic design has a detented enable position (position 2)
- Design meets or exceeds: ANSI RIA R15.06 and ISO 10218 Robot safety standard, ANSI B11.19 Performance Criteria for Safeguards, and ANSI NFPA 79 (2007) and IEC 60204-1 (2000) Electrical Requirements for Industrial Machines

### ED1G Series Enabling Devices, Stop Control Devices

Contact Configuration	Additional Push-Button Switch	Environmental Rating	Model
2 NO & 1 NC Aux	—	IP66	ED1G-L21SM-1N
1 NO & 1 NC Aux & 1 NO Momentary Push Button	Momentary Push Button	IP65	ED1G-L21SMB-1N
2 NO & 2 NO Momentary Push Button	Momentary Push Button	IP65	ED1G-L20MB-1N



ED9Z-GH1

*Additional bracket information is available.  
See page 729*



ED1G-L21SM-1N Model



ED1G-L21SMB-1N Model

SD01 - ED1G-L21SM-1N Series

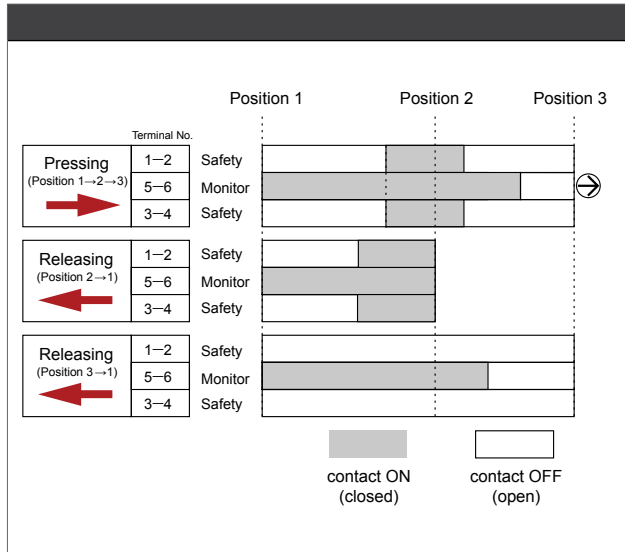

SD02 - ED1G-L21SMB-1N Series

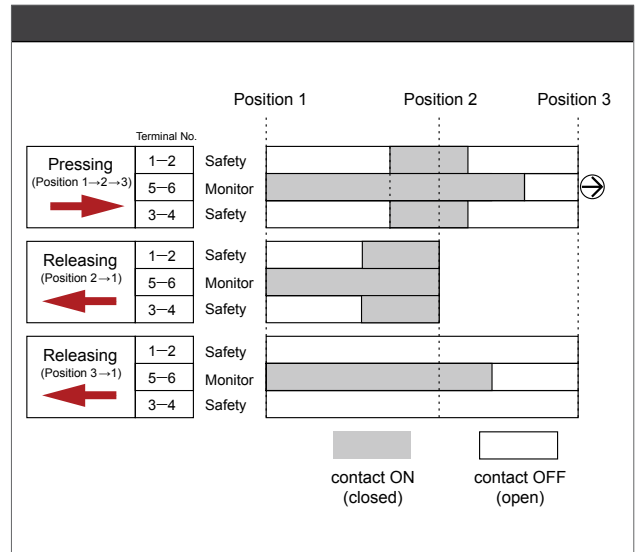

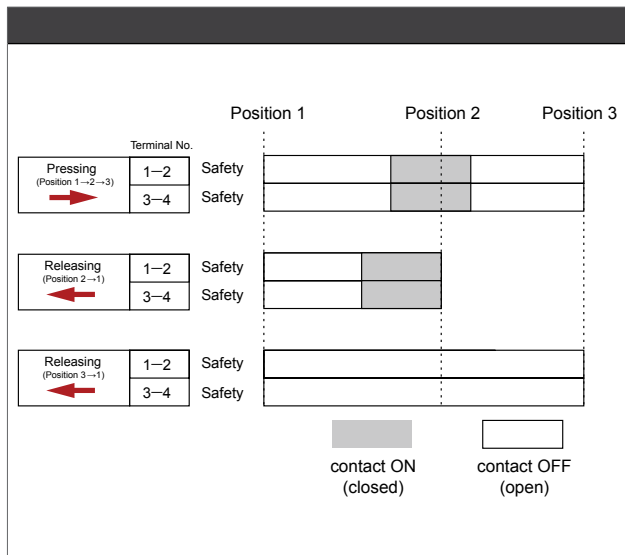

SD03 - ED1G-L20MB-1N Series









ED1G Enabling Device Specifications

Supply Voltage and Current	250 V ac/dc																																																																																								
Impulse Withstand Voltage	Three Position Switch: 2.5 kV Momentary pushbutton: 1.5 kV																																																																																								
Output Contact Ratings	<p>Rated Insulation Voltage (UI): 3-position switch 250 V; momentary push button 125 V                      Rated Thermal Current (Ith): 2.5 A*                      *40 °C ≤ operating temperature &lt; 50 °C: 2 A (4 contacts under load)                      *50 °C ≤ operating temperature ≤ 60 °C: 1.5 A (3 contacts under load)</p> <table border="1" style="width: 100%; border-collapse: collapse;"> <thead> <tr> <th colspan="5">Rated Current (Ie) 3-Position Switch Terminals 1-2 and 3-4 (all models)</th> </tr> <tr> <th colspan="2">Rated Voltage Ue</th> <th>30 V</th> <th>125 V</th> <th>250 V</th> </tr> </thead> <tbody> <tr> <td rowspan="2">AC</td> <td>Resistive load (AC-12)</td> <td>—</td> <td>1 A</td> <td>0.5 A</td> </tr> <tr> <td>Inductive load (AC-15)</td> <td>—</td> <td>0.7 A</td> <td>0.5 A</td> </tr> <tr> <td rowspan="2">DC</td> <td>Resistive load (DC-12)</td> <td>1 A</td> <td>0.2 A</td> <td>—</td> </tr> <tr> <td>Inductive load (DC-13)</td> <td>0.7 A</td> <td>0.1 A</td> <td>—</td> </tr> </tbody> </table> <table border="1" style="width: 100%; border-collapse: collapse;"> <thead> <tr> <th colspan="5">Rated Current (Ie) Monitor Switch Terminals 5-6 (models..-L21SM.. and..-L21SMB..)</th> <th colspan="5">Rated Current (Ie) Momentary Push Button Switch Terminals 7-8 (model ..-ED1G-L21SMB-1N..); 5-6 and 7-8 (model ED1G-L20MB-1N)</th> </tr> <tr> <th colspan="2">Rated Voltage Ue</th> <th>30 V</th> <th>125 V</th> <th>250 V</th> <th colspan="2">Rated Voltage Ue</th> <th>30 V</th> <th>125 V</th> <th>250 V</th> </tr> </thead> <tbody> <tr> <td rowspan="2">AC</td> <td>Resistive load (AC-12)</td> <td>—</td> <td>2 A</td> <td>1 A</td> <td rowspan="2">AC</td> <td>Resistive load (AC-12)</td> <td>—</td> <td>0.5 A</td> <td>—</td> </tr> <tr> <td>Inductive load (AC-15)</td> <td>—</td> <td>1 A</td> <td>0.5 A</td> <td rowspan="2">DC</td> <td>Inductive load (DC-15)</td> <td>—</td> <td>0.3 A</td> <td>—</td> </tr> <tr> <td rowspan="2">DC</td> <td>Resistive load (DC-12)</td> <td>2 A</td> <td>0.4 A</td> <td>0.2 A</td> <td rowspan="2">DC</td> <td>Resistive load (AC-12)</td> <td>1 A</td> <td>0.2 A</td> <td>—</td> </tr> <tr> <td>Inductive load (DC-13)</td> <td>1 A</td> <td>0.22 A</td> <td>0.1 A</td> <td>Inductive load (DC-13)</td> <td>0.7 A</td> <td>0.1 A</td> <td>—</td> </tr> </tbody> </table>				Rated Current (Ie) 3-Position Switch Terminals 1-2 and 3-4 (all models)					Rated Voltage Ue		30 V	125 V	250 V	AC	Resistive load (AC-12)	—	1 A	0.5 A	Inductive load (AC-15)	—	0.7 A	0.5 A	DC	Resistive load (DC-12)	1 A	0.2 A	—	Inductive load (DC-13)	0.7 A	0.1 A	—	Rated Current (Ie) Monitor Switch Terminals 5-6 (models..-L21SM.. and..-L21SMB..)					Rated Current (Ie) Momentary Push Button Switch Terminals 7-8 (model ..-ED1G-L21SMB-1N..); 5-6 and 7-8 (model ED1G-L20MB-1N)					Rated Voltage Ue		30 V	125 V	250 V	Rated Voltage Ue		30 V	125 V	250 V	AC	Resistive load (AC-12)	—	2 A	1 A	AC	Resistive load (AC-12)	—	0.5 A	—	Inductive load (AC-15)	—	1 A	0.5 A	DC	Inductive load (DC-15)	—	0.3 A	—	DC	Resistive load (DC-12)	2 A	0.4 A	0.2 A	DC	Resistive load (AC-12)	1 A	0.2 A	—	Inductive load (DC-13)	1 A	0.22 A	0.1 A	Inductive load (DC-13)	0.7 A	0.1 A	—
Rated Current (Ie) 3-Position Switch Terminals 1-2 and 3-4 (all models)																																																																																									
Rated Voltage Ue		30 V	125 V	250 V																																																																																					
AC	Resistive load (AC-12)	—	1 A	0.5 A																																																																																					
	Inductive load (AC-15)	—	0.7 A	0.5 A																																																																																					
DC	Resistive load (DC-12)	1 A	0.2 A	—																																																																																					
	Inductive load (DC-13)	0.7 A	0.1 A	—																																																																																					
Rated Current (Ie) Monitor Switch Terminals 5-6 (models..-L21SM.. and..-L21SMB..)					Rated Current (Ie) Momentary Push Button Switch Terminals 7-8 (model ..-ED1G-L21SMB-1N..); 5-6 and 7-8 (model ED1G-L20MB-1N)																																																																																				
Rated Voltage Ue		30 V	125 V	250 V	Rated Voltage Ue		30 V	125 V	250 V																																																																																
AC	Resistive load (AC-12)	—	2 A	1 A	AC	Resistive load (AC-12)	—	0.5 A	—																																																																																
	Inductive load (AC-15)	—	1 A	0.5 A		DC	Inductive load (DC-15)	—	0.3 A	—																																																																															
DC	Resistive load (DC-12)	2 A	0.4 A	0.2 A	DC		Resistive load (AC-12)	1 A	0.2 A	—																																																																															
	Inductive load (DC-13)	1 A	0.22 A	0.1 A		Inductive load (DC-13)	0.7 A	0.1 A	—																																																																																
Contact Resistance	100 mohm max.																																																																																								
Insulation Resistance	Live to dead metal parts: 100 Mohm min.		Positive to negative live parts: 100 Mohm min.																																																																																						
Recommended Wire/Cable Size	Wire: 0.14 to 1.5 mm <sup>2</sup> (25 AWG to 16 AWG)		Cable: ø 7 to 13 mm M20 conduit																																																																																						
Short Circuit Protection	250 V / 10A fast blow fuse (IEC 60127-1)		Conditional short circuit current: 50 A (250 V)																																																																																						
Vibration Resistance	Operating extremes: 5 to 55 Hz, half amplitude 0.5 mm minimum Damage limits: 16.7 Hz, half amplitude 1.5 mm minimum																																																																																								
Shock Resistance	Operating extremes: 150 m/s <sup>2</sup> (15 G)		Damage limits: 1,000 m/s <sup>2</sup> (100 G)																																																																																						
Mechanical Life	Positions 1 & 2 only: 1,000,000 operations minimum Operating frequency: 1,200 operations per hour maximum		Positions 1, 2 & 3: 100,000 operations minimum																																																																																						
Electrical Life	100,000 minimum at rated load																																																																																								
Pollution Degree	3																																																																																								
Terminal Pulling Strength	20 N minimum																																																																																								
Terminal Screw Torque	0.5 to 0.6 N																																																																																								
Operating Conditions (indoor use only)	Temperature: -10 to +60 °C (no freezing)		Humidity: 45 to 85% RH max. (no condensation)																																																																																						
	Storage Temperature: -40 to +80 °C (no freezing)																																																																																								
Construction	Polyamide housing and cable gland, NBR/PVC polyblend rubber grip switch boot; model ED1G-L21SM-1N meets IP66; other models meet IP65																																																																																								
Design Standards	IEC 60947-5-1, EN 60947-5-1, JIS C8201-5-1, UL 508, CSA C22.2 No. 14, GS-ET-22																																																																																								
Certifications	 																																																																																								



## Interlock Switches

Safety interlock switches respond when a guard opens. Interlock switches feature “positive opening” contacts for high reliability and withstand attempts to override the switch and defeat the system.

Series	Description	Style	Protection Rating	Housing Material
	<p><b>Magnetic style</b> page 642</p>	<p>Non-contact</p>	<p>IP67</p>	<p>Plastic</p>
	<p><b>Hinge style</b> page 646</p>	<p>Load bearing and rotating</p>	<p>IP67</p>	<p>Plastic &amp; Metal</p>
	<p><b>Two piece key actuator style</b> page 654</p>	<p>Flat pack and limit switch</p>	<p>IP65</p>	<p>Plastic &amp; Metal</p>
	<p><b>Locking style</b> page 666</p>	<p>Spring or solenoid locking</p>	<p>IP67</p>	<p>Plastic &amp; Metal</p>

# Magnet Style

## Non-Contact Safety Interlock Switches



- Accommodating to misalignment
- Sealed components resist water and dirt
- Coded magnets minimize the risk of intentional defeat
- Three housing styles available for flat or 30 mm barrel mounting
- For safety applications, switch must be used with Gate Monitoring Module, Safety Controller or comparable control system

### SI-MAG Magnet Style Safety Switches

Description	Contacts	Sensor Cable	Switching Distance		Models	
			Min. ON	Max. OFF		
	Sensor	1 NO & 1 NC	3 m	—	—	SI-MAG1SM
	Sensor	1 NO & 1 NC	3 m	—	—	SI-MAG1SMCO†
	Coded Magnet	—	—	0-3 mm	3-14 mm	SI-MAG1MM
	Coded Magnet	—	—	0-3 mm	3-14 mm	SI-MAG1MM90*
	Coded Magnet	—	—	2-8 mm	8-16 mm	SI-MAG1MMHF
	Sensor	1 NO & 1 NC	3 m	—	—	SI-MAG2SM
	Coded Magnet	1 NO & 1 NC	—	0-4 mm	4-8 mm	SI-MAG2MM
	Sensor	1 NO & 1 NC	3 m	—	—	SI-MAG3SM
	Coded Magnet	—	—	0-3 mm	3-7 mm	SI-MAG3MM

NC = Normally Closed Output, NO = Normally Open Output

#### Connection options:

For 9 m cable, add suffix W/30 to the 3 m model number (example, SI-MAG1SM W/30).

\* Difference is in Direction of Approach. See page 646 for more information.

† Cable opposite

NOTE: The sensor and its magnet must be mounted at a minimum distance of 15 mm from any magnetized or ferrous material (example, steel) for proper operation. SFA-IMB1 or SFA-IMB2 can be used as spacers (see page 646). Depending on the installation, multiple brackets may be required.



SI-MAG1SM.. and SI-MAG1MM.. Models

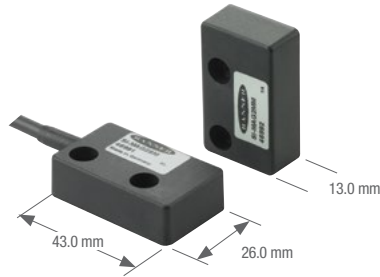

SI-MAG2SM and SI-MAG2MM Models



SI-MAG3SM and SI-MAG3MM Models

### SI-MAG Safety Switches Specifications

Switching Elements	Three pole-stable reed switches
Repeat Switching Accuracy	± 0.1 mm
Construction	Epoxy-encapsulated circuit in polyamide housing
Environmental Rating	NEMA 4X; IP67
Switching Capacity	30 V dc max. @ 0.25 W
Operating Temperature	-5 to +70 °C
Connections	Integral PVC-jacketed 3 m 4-wire cable. Cable O.D. is 5 mm. Wires are 24 AWG. (0.25 mm)

NOTE: See page 646 for direction of approach information.

## Monitoring Control Module (required for a complete system)

	Description	Models	Product Information
	<ul style="list-style-type: none"> <li>The gate module monitors up to 20 Banner coded magnets for contact failure or wiring fault</li> <li>Two-channel operation monitors redundant switches on a single guard; one-channel operation monitors single switches on two guards</li> <li>Two redundant output switching channels connect to control-reliable power interrupt circuits and are rated for up to 250 V ac at up to 6 A</li> <li>The reset input can be used for external device monitoring (EDM)</li> <li>The gate monitoring module uses 24 V ac/dc at less than 150 mA</li> </ul>	GM-FA-10J	Page 698
	<ul style="list-style-type: none"> <li>Control system monitors a variety of input devices such as e-stop buttons, rope pulls, enabling devices, protective safety stops, interlocked guards or gates, optical sensors, two-hand controls and safety mats</li> <li>Intuitive programming environment for easy implementation</li> <li>Configure inputs, outputs and functionality of the controller for more usability</li> <li>Base controller allows eight of the 26 inputs to be configured as outputs for efficient terminal utilization</li> <li>Ethernet models available providing up to 64 virtual status outputs, fault diagnostic codes and messages</li> </ul>	SC26-2, XS26-2  SC26-2D, XS26-2D  SC26-2E, XS26-2E  SC26-2DE, XS26-2DE	Page 584
	<ul style="list-style-type: none"> <li>One controller provides configurable monitoring of multiple safety devices</li> <li>22 input terminals can monitor both contact-based and PNP solid-state input devices</li> <li>Three pairs of independent solid-state safety outputs can be used with selectable one- or two-channel external device monitoring</li> <li>Ten configurable non-safety status outputs track inputs, outputs, lockout, I/O status and other functions</li> <li>All SC22-3 modules use 24 V dc</li> <li>10/100 Base TX Ethernet communication option using EtherNet/IP and Modbus TCP protocols (SC22-3E models)</li> </ul>	SC22-3-S...  SC22-3-C...  SC22-3E-S...  SC22-3E-C...	Page 592

Magnet-Style Interlocks: Direction of Approach for Sensor/Magnet Pairs

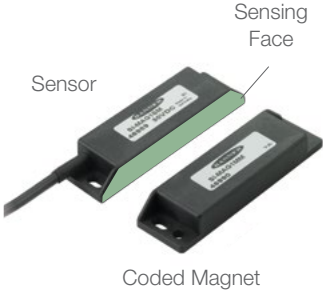
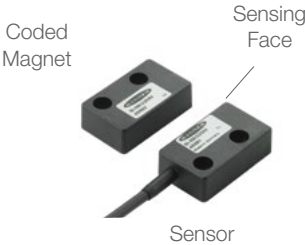
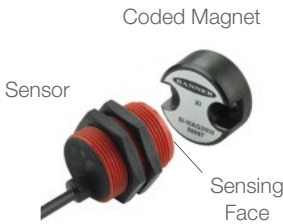
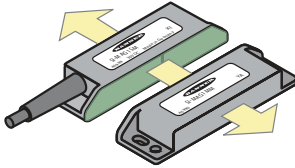
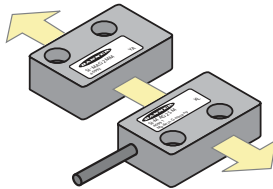
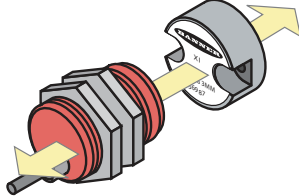
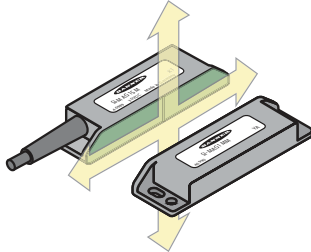
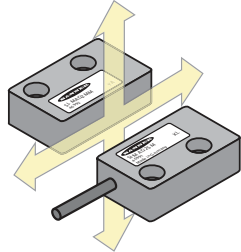
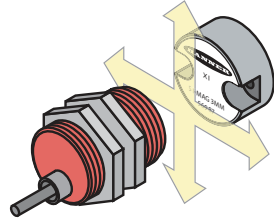
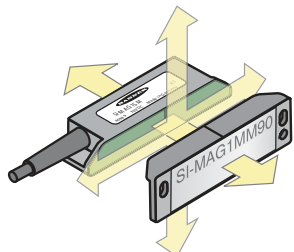
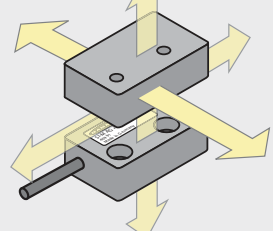
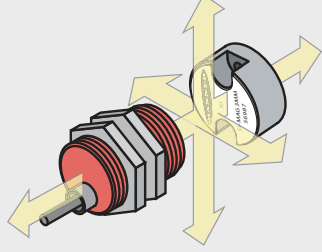
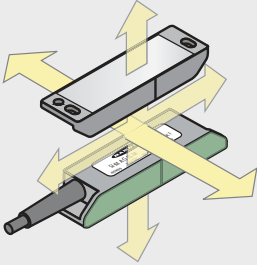
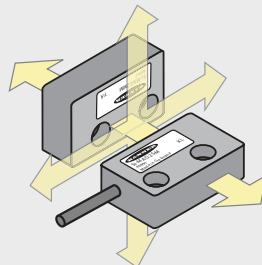
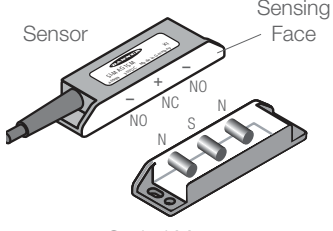
Model SI-MAG1	Model SI-MAG2	Model SI-MAG3
 <p>Sensing Face</p> <p>Sensor</p> <p>Coded Magnet</p>	 <p>Coded Magnet</p> <p>Sensing Face</p> <p>Sensor</p>	 <p>Coded Magnet</p> <p>Sensor</p> <p>Sensing Face</p>
<p><b>Correct</b></p> <p>Movement is <b>perpendicular</b> to the sensing face.</p> 	<p><b>Correct</b></p> <p>Movement is <b>perpendicular</b> to the sensing face.</p> 	<p><b>Correct</b></p> <p>Movement is <b>perpendicular</b> to the sensing face.</p> 
<p><b>Correct</b></p> <p>Movement is <b>parallel</b> to the sensing face.</p> 	<p><b>Correct</b></p> <p>Movement is <b>parallel</b> to the sensing face.</p> 	<p><b>Correct</b></p> <p>Movement is <b>parallel</b> to the sensing face.</p> 
<p><b>Correct</b></p> <p>90° approach of sensor and magnet is approved only for model <b>SI-MAG1MM90</b>.</p> 	<p><b>Incorrect</b></p> <p>Label to label approach of sensor and magnet is not possible.</p> 	<p><b>Incorrect</b></p> <p>Magnet orientation relative to magnet sensor cable is incorrect.</p> 
<p><b>Incorrect</b></p> <p>Label to label approach of sensor and magnet is not possible.</p> 	<p><b>Incorrect</b></p> <p>90° approach of sensor and magnet is not possible.</p> 	<p><b>Detail of Interiors</b></p>  <p>Sensing Face</p> <p>Sensor</p> <p>Coded Magnet</p>

NOTE: With SI-MAG1C Controller, approach speed for all magnet-style switches must be greater than 0.2 ms.  
 With GM-FA-10J Controller, approach speed must be greater than 0.1 ms.







# SI-HG63

## Hinge Style Switches

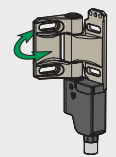

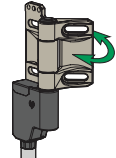
- Load bearing and operate to a full 270° range of motion with safety switching point
- Safety switching point is adjustable and repositionable
- Housing is constructed of corrosion-resistant stainless steel or zinc die-cast
- Design meets positive opening requirements for safety interlocks (IEC 60947-5-1)
- Right-hinge QD, left-hinge QD, and right-angle QD hinge models available
- High degree of tamper-resistances

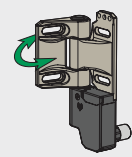
### SI-HG63 Hinge Style Switches, 63 mm

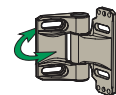
Actuator Type		Contact(s)	Construction	Models
 In-line QD Integral load bearing		2 NC & 1 NO	Stainless Steel	SI-HG63FQDR
			Zinc Die-Cast	SI-HGZ63FQDR
 In-line QD Integral load bearing		2 NC & 1 NO	Stainless Steel	SI-HG63FQDL
			Zinc Die-Cast	SI-HGZ63FQDL
 Right-angle QD Integral load bearing		2 NC & 1 NO	Stainless Steel	SI-HG63FQDRR
			Zinc Die-Cast	SI-HGZ63FQDRR
 Blank hinge		—	Stainless Steel	SI-HG63A
			Zinc Die-Cast	SI-HGZ63A

 Hinge 270° NC = Normally closed contact, NO = Normally open contact

 Connection options: A model with a QD requires a mating cordset.

For contact/switching diagrams see page 672.





6-Pin

**Micro-Style to Flying Leads**  
Straight connector models listed; for right-angle, add **RA** to the end of the model number (example, **MQEAC-806RA**)

- MQEAC-606**  
2 m (6')
- MQEAC-615**  
5 m (25')
- MQEAC-630**  
9 m (50')

Additional cordset information is available.  
See page 758

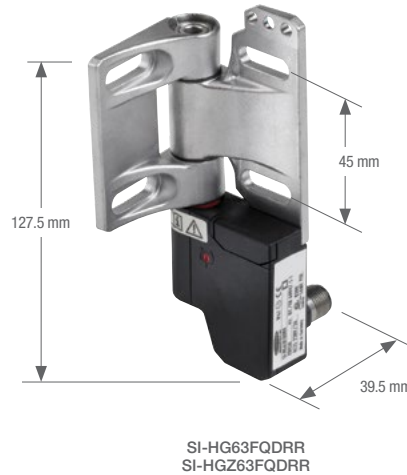

### SI-HG63 Hinge Style Switches Specifications

<b>Contact Rating</b>	3 A @ 230V ac max., 1.0 A @ 24V dc max. 2.5 kV max. transient tolerance
<b>European Rating</b>	U <sub>i</sub> = 250 V, U <sub>e</sub> = 230 V ac, 24 V dc, I <sub>the</sub> = 4A <b>Utilization categories: AC-15:</b> U <sub>e</sub> /I <sub>e</sub> 230 V / 3A; <b>DC-13:</b> U <sub>e</sub> /I <sub>e</sub> 24 V / 1A (IEC/EN 90497-5-1)
<b>Switching Frequency</b>	Max. 300 operations/h (5 operations per minute)
<b>Switching Angle</b>	<b>NC contact:</b> ±3° <b>NO contact:</b> ±9° <b>Tolerance for all angles:</b> 1.5°
<b>Mechanical Life</b>	1 million operations (Excessive loading (force) and/or vibration, as well as improper installation, can reduce the service life)
<b>Short Circuit Protection</b>	4 amp Slow Blow. Recommended external fusing or overload protection.
<b>Operating Range</b>	0° to 270°
<b>Wire Connections</b>	6-pin Micro-style quick-disconnect fitting (M12 Dual-Key-Way).
<b>Construction</b>	<b>SI-HG63.. Hinge:</b> Cast Stainless (X22CrNi 17), Switch: PBT <b>SI-HGZ63.. Hinge:</b> Zinc Die Cast (Nickel Finish), Switch: PBT
<b>Environmental Rating</b>	IEC IP67 acc. IEC/EN60529
<b>Operating Conditions</b>	<b>Temperature:</b> -25 to +70 °C (connecting cable permanently mounted; no freezing over/no condensation)
<b>Weight</b>	SI-HG63.. ≈ 0.45 kg, SI-HG63A ≈ 0.27 kg SI-HGZ63.. ≈ 0.5 kg, SI-GHZ63A ≈ 0.22 kg
<b>Application Note</b>	To avoid excessive radial stress in applications containing large doors, the hinge switch should be mounted either in pairs of two, or in conjunction with a blank hinge (see page 646).
<b>Certifications</b>	
<b>Contact configuration and Switching Diagram</b>	SD001 (p. 672)

# SI-HG80

## Hinge Style Switches



- Load bearing and operate to a full 180° range of motion
- Housing is constructed of corrosion-resistant zinc die-cast
- One-piece switch eliminates need for alignment, engagement and risk of breakage of a separate actuator
- Design meets positive opening requirements for safety interlocks (IEC 60947-5-1)
- High degree of tamper-resistance

### SI-HG80 Hinge Style Switches, 80 mm

Actuator Type		Contact(s)	Connection	Models
 In-line QD Integral load bearing		SPDT (Form C)	4-pin Micro QD	SI-HG80DQD
 Right-angle QD Integral load bearing		SPDT (Form C)	4-pin Micro QD	SI-HG80DQDR
 Blank hinge		—	—	SI-HG80A

 Hinge 180°    SPDT = Single-Pole, Double-Throw Contacts

 Connection options: A model with a QD requires a mating cordset.

For contact/switching diagrams see page 672.



6-Pin

**Micro-Style to Flying Leads**  
Straight connector models listed; for right-angle, add **RA** to the end of the model number (example, **MQEAC-806RA**)

- MQEAC-606**  
2 m (6')
- MQEAC-615**  
5 m (25')
- MQEAC-630**  
9 m (50')

Additional cordset information is available.  
See page 758



SI-HG80DQDR

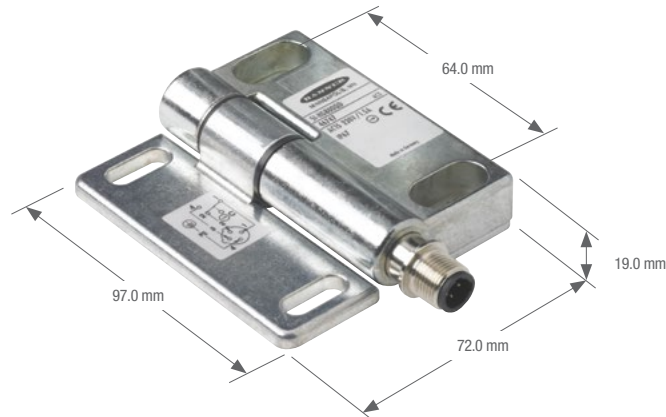

SI-HG80DQD

### SI-HG80 Hinge Style Switches Specifications

<b>Contact Rating</b>	3 A @ 250 V ac max., 0.5 A @ 60 V dc max. 2.5 kV max. transient tolerance NEMA A300 P300
<b>European Rating</b>	<b>Utilization categories:</b> AC15 and DC13 (IEC 90497-5-1) Ui = 250 V ac, Ith= 3A
<b>Minimum Switching Speed</b>	20 operations per minute
<b>Mechanical Life</b>	1 million operations
<b>Short Circuit Protection</b>	6 amp Slow Blow, 10 amp Fast Blow. Recommended external fusing or overload protection.
<b>Force Exerted by Guard per Switch</b>	<b>Axial:</b> 750 N max. <b>Radial:</b> 1000 N max.
<b>Operating Range</b>	0° to 180°
<b>Wire Connections</b>	4-pin Micro-style quick-disconnect (QD) fitting.
<b>Construction</b>	Zinc Die-cast (GD-Zn)
<b>Environmental Rating</b>	NEMA 4; IP67
<b>Operating Conditions</b>	<b>Temperature:</b> -25 to +70 °C
<b>Weight</b>	0.40 kg
<b>Application Notes</b>	To avoid excessive radial stress in applications containing large doors, the hinge switch should be mounted either in pairs of two, or in conjunction with a blank hinge.
<b>Certifications</b>	
<b>Contact Configuration and Switching Diagrams</b>	SD002 (p. 672)





# SI-LS32H

## Hinge Style Switches

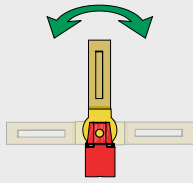

- Actuator head rotates in 90° increments
- Built-in hinge lever attaches to doors or flaps, which open 90° in one direction
- Housing is constructed of glass reinforced thermoplastic with plated steel actuator
- One-piece switch eliminates need for alignment, engagement and risk of breakage of a separate actuator
- Design meets positive opening requirements for safety interlocks (IEC 60947-5-1)

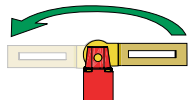
### SI-LS31H Hinge Lever Style Switches, 31 mm

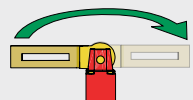
Actuator Type		Contact(s)	Models*
 Vertical Hinged Lever ± 90°		1 NC & 1 NO	SI-LS31HGD
		2 NC	SI-LS31HGE
 Right-Hand Hinged Lever 180°		1 NC & 1 NO	SI-LS31HGRD
		2 NC	SI-LS31HGRE
 Left-Hand Hinged Lever 180°		1 NC & 1 NO	SI-LS31HGLD
		2 NC	SI-LS31HGLE



Hinge 90°



One-Directional 180°



One-Directional 180°

NC = Normally Closed Contact, NO = Normally Open Contact

\* Contact factory for integral quick-disconnect (QD) and pigtail QD options.

# SI-LS31R

## Hinge Style Switches



- Actuator head rotates in 90° increments
- Rotating actuator connects directly to door hinge
- Housing is constructed of glass reinforced thermoplastic with plated steel actuator
- One-piece switch eliminates need for alignment, engagement and risk of breakage of a separate actuator
- Design meets positive opening requirements for safety interlocks (IEC 60947-5-1)

### SI-LS31R Rotary Hinge Style Switches, 31 mm

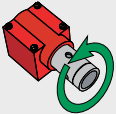
Actuator Type	Contact(s)	Models*
 Rotary Shaft	1 NC & 1 NO	SI-LS31RTD
	2 NC	SI-LS31RTE

 360° Rotary    NC = Normally Closed Contact, NO = Normally Open Contact

\* Contact factory for integral quick-disconnect (QD) and pigtail QD options.

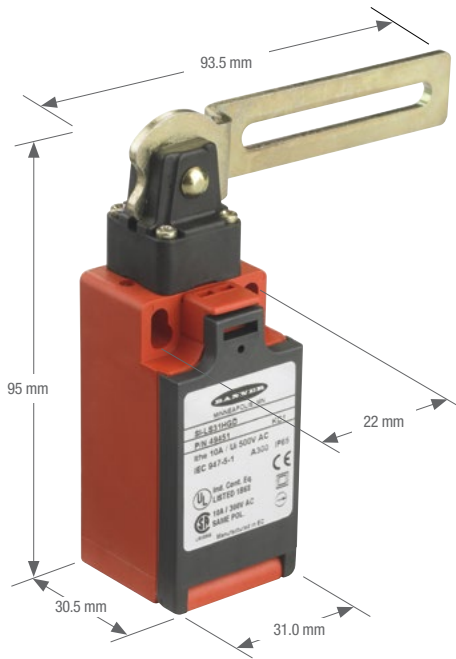

SI-LS32H

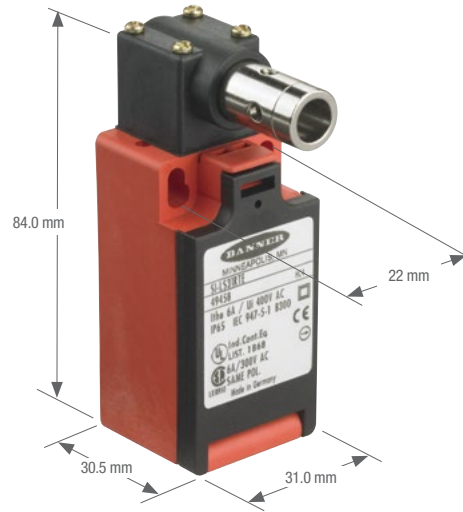

SI-LS31R

SI-LS31 Hinge Style Switches Specifications

<b>Contact Rating</b>	10A @ 24 V ac, 10A @ 110 V ac, 6A @ 230 V ac, 6A @ 24 V dc		2.5 kV max. transient tolerance	NEMA A300 P300															
<b>European Rating</b>	<p><b>Utilization categories:</b> AC15 and DC13  <math>U_e = 500V</math> ac  <math>I_{th} = 10A</math></p>	<table border="1"> <thead> <tr> <th colspan="3">40-60 Hz</th> </tr> <tr> <th><math>U_e</math> V</th> <th><math>I_o/AC-15</math> A</th> <th><math>I_o/DC-13</math> A</th> </tr> </thead> <tbody> <tr> <td>24</td> <td>10</td> <td>6</td> </tr> <tr> <td>110</td> <td>10</td> <td>1</td> </tr> <tr> <td>230</td> <td>6</td> <td>.4</td> </tr> </tbody> </table>			40-60 Hz			$U_e$ V	$I_o/AC-15$ A	$I_o/DC-13$ A	24	10	6	110	10	1	230	6	.4
40-60 Hz																			
$U_e$ V	$I_o/AC-15$ A	$I_o/DC-13$ A																	
24	10	6																	
110	10	1																	
230	6	.4																	
<b>Contact Material</b>	Silver-nickel alloy																		
<b>Maximum Switching Speed</b>	50 operations per minute																		
<b>Mechanical Life</b>	1 million operations																		
<b>Required Actuation Force</b>	<b>SI-LS31R models:</b> 10 N cm		<b>SI-LS31H models:</b> 15 N cm																
<b>Short Circuit Protection</b>	6 amp Slow Blow, 10 amp Fast Blow. Recommended external fusing or overload protection.																		
<b>Wire Connections</b>	Screw terminals with pressure plates accept the following wire sizes – <b>Stranded and solid:</b> 20 AWG (0.5 mm <sup>2</sup> ) to 16 AWG (1.5 mm <sup>2</sup> ) for one wire <b>Stranded:</b> 20 AWG (0.5 mm <sup>2</sup> ) to 18 AWG (1.0 mm <sup>2</sup> ) for two wires																		
<b>Cable Entry</b>	M20 x 1.5 threaded entrance	Adapter supplied to convert from M20 x 1.5 to 1/2" - 14 NPT threaded entrance																	
<b>Construction</b>	Glass fiber-reinforced thermoplastic UL94-VO rating; plated steel actuator																		
<b>Environmental Rating</b>	IP65																		
<b>Operating Conditions</b>	<b>Temperature:</b> -30 to +80 °C																		
<b>Weight</b>	0.09 Kg																		
<b>Certifications</b>																			
<b>Contact Configuration and Switching Diagrams</b>	<b>SI-LS31R models:</b> SD009 and SD010 (p. 673) <b>SI-LS31H models:</b> SD003, SD004, SD005, SD006, SD007 and SD008 (p. 672)																		

# SI-LS100

## Non-Locking Plastic Safety Interlock Switches



- Mechanically coded actuators minimize intentional tampering or defeat
- 100 mm plastic style switch
- Rotating head requires no tools
- Limit switch style
- Actuator engagement from four side or four top positions

### SI-LS100 Plastic Style Switches (kits), 100 mm

Actuator Type		Interlock	Contact(s)	Kit Model*
SI-QS-SSA-2 Straight Rigid In-Line		SI-LS100F	2 NC & 1 NO	SI-LS100SF
SI-QS-SSA-3 Rigid In-Line		SI-LS100F	2 NC & 1 NO	SI-LS100SRAF
 SI-QS-SSU Flexible In-Line		SI-LS100F	2 NC & 1 NO	SI-LS100MRFF



Multi-Directional

NC = Normally Closed Contact, NO = Normally Open Contact

\* A kit contains an interlock and actuator. Individual interlocks (without actuator) are for replacement purposes only. Contact factory for integral quick-disconnect (QD) and pigtail QD options.



# SI-LS83

## Non-Locking Plastic Safety Interlock Switches



- Mechanically coded actuators minimize intentional tampering or defeat
- 83 mm plastic style switch
- Rotating head requires no tools
- Limit switch style
- Actuator engagement from four side or four top positions

### SI-LS83 Plastic Style Switches (kits), 83 mm

Actuator Type		Interlock		Kit Model*
SI-QS-SSA-2 Straight Rigid In-Line		SI-LS83D	1 NC & 1 NO	SI-LS83SD
SI-QS-SSA-3 Rigid In-Line		SI-LS83D	1 NC & 1 NO	SI-LS83SRAD
 SI-QS-SSU Flexible In-Line		SI-LS83D	1 NC & 1 NO	SI-LS83MRFD
SI-QS-SSA-2 Straight Rigid In-Line		SI-LS83E	2 NC	SI-LS83SE
SI-QS-SSA-3 Rigid In-Line		SI-LS83E	2 NC	SI-LS83SRAE
 SI-QS-SSU Flexible In-Line		SI-LS83E	2 NC	SI-LS83MRFE

Multi-Directional      NC = Normally Closed Contact, NO = Normally Open Contact

\* A kit contains an interlock and actuator. Individual interlocks (without actuator) are for replacement purposes only. Contact factory for integral quick-disconnect (QD) and pigtail QD options.

# SI-QS90

## Non-Locking Plastic Safety Interlock Switches





- Mechanically coded actuators minimize intentional tampering or defeat
- 90 mm flat-pack style switch
- Rotating head requires no tools
- Rotating head allows actuator engagement from front or back or either of two top positions

### SI-QS90 Flat-Pack Style Switches(kits), 90 mm

Actuator Type		Interlock	Contact(s)	Kit Model*
SI-QS-SSA-4 Rigid In-Line		SI-QS90D	1 NC & 1 NO	SI-QS90MD
 SI-QS-SSU Flexible In-Line		SI-QS90D	1 NC & 1 NO	SI-QS90MFD
SI-QS-SSA Rigid In-Line & SI-QS-100 High-force Accessory		SI-QS90D	1 NC & 1 NO	SI-QS90MD-100 (High-Force)
SI-QS-SSA-4 Rigid In-Line		SI-QS90E	2 NC	SI-QS90ME
 SI-QS-SSU Flexible In-Line		SI-QS90E	2 NC	SI-QS90MFE
SI-QS-SSA Rigid In-Line & SI-QS-100 High-force Accessory		SI-QS90E	2 NC	SI-QS90ME-100 (High-Force)

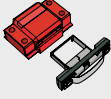

SI-QS90 Flat-Pack Style Switches(kits), 90 mm

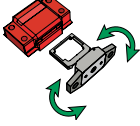
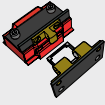
Actuator Type		Interlock	Contact(s)	Kit Model*
SI-QS-SSA-4 Rigid In-Line		SI-QS90F	2 NC & 1 NO	SI-QS90MF
 SI-QS-SSU Flexible In-Line		SI-QS90F	2 NC & 1 NO	SI-QS90MFF
SI-QS-SSA Rigid In-Line & SI-QS-100 High-force Accessory		SI-QS90F	2 NC & 1 NO	SI-QS90MF-100 (High-Force)

 Multi-Directional      NC = Normally Closed Contact, NO = Normally Open Contact

\* A kit contains an interlock and actuator. Individual interlocks (without actuator) are for replacement purposes only. Contact factory for integral quick-disconnect (QD) and pigtail QD options.



# SI-QS75

## Non-Locking Plastic Safety Interlock Switches

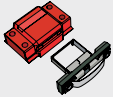

- Mechanically coded actuators minimize intentional tampering or defeat
- 75 mm flat-pack style switch
- Rotating head requires no tools
- Flat pack and limit switch styles
- Rotating head allows actuator engagement from front or back or either of two top positions

### SI-QS75 Flat-Pack Style Switches (kits), 75 mm

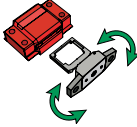
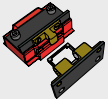
Actuator Type		Interlock	Contact(s)	Kit Model*
SI-QS-SSA-4 Rigid In-Line		SI-QS75C	1 NC	SI-QS75MC
 SI-QS-SSU Flexible In-Line		SI-QS75C	1 NC	SI-QS75MFC
SI-QS-SSA Rigid In-Line & SI-QS-100 High-force Accessory		SI-QS75C	1 NC	SI-QS75MC-100 (High-Force)



Multi-Directional    NC = Normally Closed Contact, NO = Normally Open Contact

\* A kit contains an interlock and actuator. Individual interlocks (without actuator) are for replacement purposes only. Contact factory for integral quick-disconnect (QD) and pigtail QD options.

Flat-Pack Style Switches

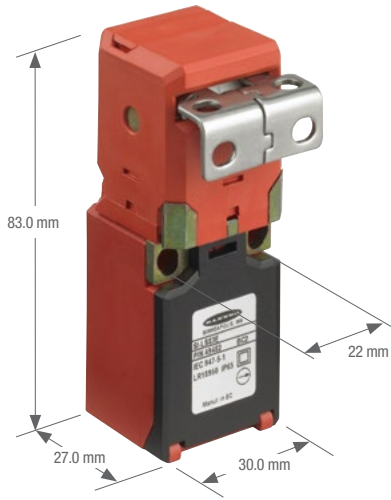

SI-LS83 Models

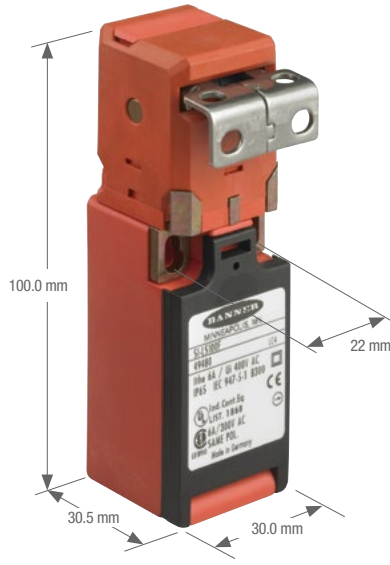

SI-LS100 Models

(both models shown with right-angle rigid in-line actuator)

Flat-Pack Style Switches

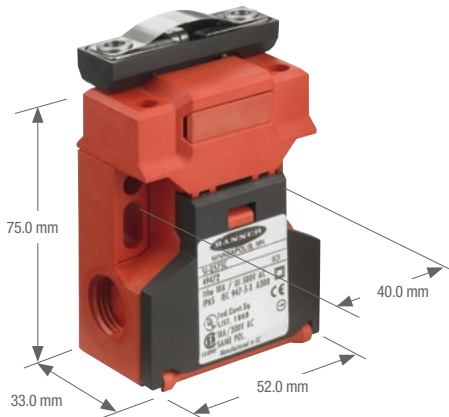





SI-QS75 Models



SI-QS90 Models

(both models shown with rigid in-line actuator)

## SI-LS83 and SI-LS100 Plastic Style Switches Specifications

Contact Rating	10A @ 24 V ac, 10A @ 110 V ac, 6A @ 230 V ac, 6A @ 24 V dc 2.5 kV max. transient tolerance NEMA A300 P300																
European Rating	<b>Utilization categories:</b> AC15 and DC13 (IEC 60947-5-1) Switches with 1 & 2 contact pairs: $U_i= 500V$ ac, $I_{th}= 10A$ Switches with 3 contact pairs: $U_i= 400V$ ac, $I_{th}= 5A$	<table border="1"> <thead> <tr> <th colspan="3">40-60 Hz</th> </tr> <tr> <th><math>U_o</math> V</th> <th><math>I_o/AC-15</math> A</th> <th><math>I_o/DC-13</math> A</th> </tr> </thead> <tbody> <tr> <td>24</td> <td>10</td> <td>6</td> </tr> <tr> <td>110</td> <td>10</td> <td>1</td> </tr> <tr> <td>230</td> <td>6</td> <td>.4</td> </tr> </tbody> </table>	40-60 Hz			$U_o$ V	$I_o/AC-15$ A	$I_o/DC-13$ A	24	10	6	110	10	1	230	6	.4
40-60 Hz																	
$U_o$ V	$I_o/AC-15$ A	$I_o/DC-13$ A															
24	10	6															
110	10	1															
230	6	.4															
Contact Material	Silver-nickel alloy																
Maximum Switching Speed	30 operations per minute																
Maximum Actuator Speed	1 m/second																
Mechanical Life	1 million operations																
Minimum Actuator Engagement Radius	<b>In-line actuators:</b> 150 mm <b>Flexible actuators:</b> 50 mm in all directions																
Actuation Extraction Force	12 N																
Short Circuit Protection	6 amp Slow Blow, 10 amp Fast Blow. Recommended external fusing or overload protection.																
Wire Connections	<b>Stranded and solid:</b> 20 AWG (0.5 mm <sup>2</sup> ) to 18 AWG (1.0 mm <sup>2</sup> ) for one wire <b>Stranded:</b> 20 AWG (0.5 mm <sup>2</sup> ) to 18 AWG (1.0 mm <sup>2</sup> ) for two wires																
Cable Entry	M20 x 1.5 for SI-LS100 and M16 x 1.5 for SI-LS83 threaded entrance. Adapter supplied to convert to 1/2"- 14 NPT threaded entrance.																
Construction	Glass fiber-reinforced thermoplastic UL94-VO rating																
Environmental Rating	IP65 NOTE: Addition of a No. 3 x 1/4" screw (max) to the wiring access door increases sealing to IP67; NEMA 4X																
Operating Conditions	<b>Temperature:</b> -30 to +80 °C																
Weight	SI-LS83 models: 0.12 kg SI-LS100 models: 0.13 kg																
Certifications	     AUXILIARY DEVICE <b>LISTED</b>																
Contact Configuration and Switching Diagrams	SI-LS100 models: SD011 (p. 673) SI-LS83 models: SD012 and SD013 (p. 673)																

SI-QS75 and SI-QS90 Flat-Pack Style Switches Specifications

<b>Contact Rating</b>	10A @ 24V ac, 10A @ 110V ac, 6A @ 230V ac, 6A @ 24V dc 2.5 kV max. transient tolerance NEMA A300 P300																
<b>European Rating</b>	<p><b>Utilization categories:</b> AC15 and DC13 (IEC 60947-5-1) Switches with 1 &amp; 2 contact pairs: <math>U_i= 500V</math> ac, <math>I_{th}= 10A</math> Switches with 3 contact pairs: <math>U_i= 400V</math> ac, <math>I_{th}= 5A</math></p>	<table border="1"> <thead> <tr> <th colspan="3">40-60 Hz</th> </tr> <tr> <th><math>U_g</math> V</th> <th><math>I_g/AC-15</math> A</th> <th><math>I_g/DC-13</math> A</th> </tr> </thead> <tbody> <tr> <td>24</td> <td>10</td> <td>6</td> </tr> <tr> <td>110</td> <td>10</td> <td>1</td> </tr> <tr> <td>230</td> <td>6</td> <td>.4</td> </tr> </tbody> </table>	40-60 Hz			$U_g$ V	$I_g/AC-15$ A	$I_g/DC-13$ A	24	10	6	110	10	1	230	6	.4
40-60 Hz																	
$U_g$ V	$I_g/AC-15$ A	$I_g/DC-13$ A															
24	10	6															
110	10	1															
230	6	.4															
<b>Contact Material</b>	Silver-nickel alloy																
<b>Maximum Switching Speed</b>	30 operations per minute																
<b>Maximum Actuator Speed</b>	1 m/second																
<b>Mechanical Life</b>	1 million operations																
<b>Minimum Actuator Engagement Radius</b>	<p><b>In-line actuators:</b> 150 mm <b>Flexible actuators:</b> 50 mm in all directions</p>																
<b>Actuation Extraction Force</b>	<p><b>High-Force models:</b> adjustable from 50-100 N      <b>All others:</b> 10 N</p>																
<b>Short Circuit Protection</b>	6 amp Slow Blow, 10 amp Fast Blow. Recommended external fusing or overload protection.																
<b>Wire Connections</b>	<p>Screw terminals with pressure plates accept the following wire sizes – <b>For switches with one or two contacts:</b> Stranded and solid: 20 AWG (0.5 mm<sup>2</sup>) to 16 AWG (1.5 mm<sup>2</sup>) for one wire <b>Stranded:</b> 20 AWG (0.5 mm<sup>2</sup>) to 18 AWG (1.0 mm<sup>2</sup>) for two wires</p> <p><b>For switches with three contacts:</b> <b>Stranded and solid:</b> 20 AWG (0.5 mm<sup>2</sup>) to 18 AWG (1.0 mm<sup>2</sup>) for one wire <b>Stranded:</b> 20 AWG (0.5 mm<sup>2</sup>) to 18 AWG (1.0 mm<sup>2</sup>) for two wires</p>																
<b>Cable Entry</b>	M20 x 1.5 for SI-QS90 and M16 x 1.5 for SI-QS75 threaded entrance. Adapter supplied to convert to ½" - 14 NPT threaded entrance.																
<b>Construction</b>	Glass fiber-reinforced thermoplastic UL94-VO rating																
<b>Environmental Rating</b>	IP65 NOTE: Addition of a No. 3 x ¼" screw (max) to the wiring access door increases sealing to IEC IP67; NEMA 4X																
<b>Operating Conditions</b>	<b>Temperature:</b> -30 to +80 °C																
<b>Weight</b>	<p><b>SI-QS75 models:</b> 0.11 kg <b>SI-QS90 models:</b> 0.13 kg</p>																
<b>Application Notes</b>	Models with one and two contacts have three cable entry locations (bottom and two sides); models with three contacts have two cable entry locations (two sides). All entry locations are sealed with knockouts. To remove knockouts, thread the supplied M16 x 1.5 or M20 x 1.5 to ½" - 14 NPT conduit adapter or optional M16 x 1.5 or M20 x 1.5 cable gland into one of the threaded entry locations. The knockout will break open just before the adapter or cable gland bottoms out.																
<b>Certifications</b>																	
<b>Contact Configuration and Switching Diagrams</b>	<p><b>SI-QS75 models:</b> SD014 (p. 674) <b>SI-QS90 models:</b> SD015, SD016 and SD017 (p. 674)</p>																



# SI-LM40MKH

## Non-Locking Metal Safety Interlock Switches



- Mechanically coded actuators minimize intentional tampering or defeat
- Rigid or flexible in-line actuators
- Actuator head rotates to four possible positions in 90° increments
- Rugged metal housing
- Design meets positive opening requirements for safety interlocks (IEC 60947-5-1)

### SI-LM40MKH Limit Switch Style (kits), 40 mm

Actuator Type		Interlock	Contact(s)	Kit Model*
SI-QM-SSA Straight Rigid In-Line		SI-LM40KHD	1 NO & 1 NC	SI-LM40MKHD
 SI-QM-SMFA Flexible In-Line		SI-LM40KHD	1 NO & 1 NC	SI-LM40MKHFD
SI-QM-SSA Straight Rigid In-Line		SI-LM40KHE	2 NC	SI-LM40MKHE
 SI-QM-SMFA Flexible In-Line		SI-LM40KHE	2 NC	SI-LM40MKHFE





Multi-Directional

NC = Normally Closed Contact, NO = Normally Open Contact

\* A kit contains an interlock and actuator. Individual interlocks (without actuator) are for replacement purposes only. Contact factory for integral quick-disconnect (QD) and pigtail QD options.

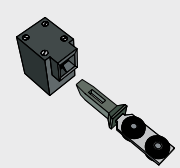

SI-LM40MKH Limit Switch Style (kits), 40 mm (cont'd)

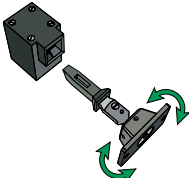
Actuator Type		Interlock	Contact(s)	Kit Model*
<p>SI-QM-SSA Straight Rigid In-Line</p>		SI-LM40KHF	2 NC & 1 NO	SI-LM40MKHF
<p> SI-QM-SMFA Flexible In-Line</p>		SI-LM40KHF	2 NC & 1 NO	SI-LM40MKHFF

 Multi-Directional      NC = Normally Closed Contact, NO = Normally Open Contact

\* A kit contains an interlock and actuator. Individual interlocks (without actuator) are for replacement purposes only. Contact factory for integral quick-disconnect (QD) and pigtail QD options.



# SI-LM40MKV

## Non-Locking Metal Safety Interlock Switches

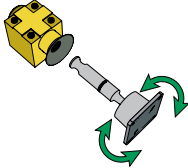

- Mechanically coded actuators minimize intentional tampering or defeat
- In-line Spring-loaded actuator; flexes in all directions
- Actuator head rotates to four possible positions in 90° increments
- Rugged metal housing
- Design meets positive opening requirements for safety interlocks (IEC 60947-5-1)

### SI-LM40MKV Limit Switch Style (kits), 40 mm

Actuator Type	Interlock	Contact(s)	Kit Model*
 SI-QM-90A Flexible In-Line	 SI-LM40KVD	1 NO & 1 NC	SI-LM40MKVD
	 SI-LM40KVE	2 NC	SI-LM40MKVE



Multi-Directional

NC = Normally Closed Contact, NO = Normally Open Contact

\* A kit contains an interlock and actuator. Individual interlocks (without actuator) are for replacement purposes only  
 Contact factory for integral quick-disconnect (QD) and pigtail QD options.

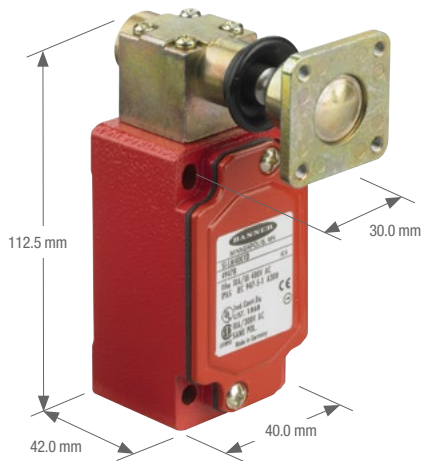

SI-LM40MKV Models  
(with flexible in-line actuator)



SI-LM40MKH Models  
(shown with rigid in-line actuator)

### SI-LM40 Limit Style Switches Specifications

<b>Contact Rating</b>	10A @ 24 V ac, 10A @ 110 V ac, 6A @ 230 V ac, 6A @ 24 V dc 2.5 kV max. transient tolerance NEMA A300 P300																			
<b>European Rating</b>	Utilization categories: AC15 and DC13 $U_i = 500V$ ac, $I_n = 10A$	<table border="1"> <thead> <tr> <th colspan="3">40-60 Hz</th> </tr> <tr> <th><math>U_o</math></th> <th><math>I_o/AC-15</math></th> <th><math>I_o/DC-13</math></th> </tr> <tr> <th>V</th> <th>A</th> <th>A</th> </tr> </thead> <tbody> <tr> <td>24</td> <td>10</td> <td>6</td> </tr> <tr> <td>110</td> <td>10</td> <td>1</td> </tr> <tr> <td>230</td> <td>6</td> <td>.4</td> </tr> </tbody> </table>	40-60 Hz			$U_o$	$I_o/AC-15$	$I_o/DC-13$	V	A	A	24	10	6	110	10	1	230	6	.4
40-60 Hz																				
$U_o$	$I_o/AC-15$	$I_o/DC-13$																		
V	A	A																		
24	10	6																		
110	10	1																		
230	6	.4																		
<b>Contact Material</b>	Silver-nickel alloy																			
<b>Maximum Switching Speed</b>	SI-LM40MKH models: 50 operations per minute SI-LM40MKV models: 10 operations per minute																			
<b>Maximum Actuator Speed</b>	SI-LM40MKH models: 1.5 m/second SI-LM40MKV models: 0.5 m/second																			
<b>Mechanical Life</b>	SI-LM40MKH models: 1 million operations SI-LM40MKV models: 25,000 operations																			
<b>Minimum Actuator Engagement Radius</b>	Rigid actuator: 400 mm Flexible actuator: 150 mm																			
<b>Actuation Extraction Force</b>	SI-LM40MKH models: 10 N SI-LM40MKV models: 20 N																			
<b>Short Circuit Protection</b>	6 amp Slow Blow, 10 amp Fast Blow. Recommended external fusing or overload protection.																			
<b>Wire Connections</b>	Screw terminals with pressure plates accept the following wire sizes – <b>Stranded and solid:</b> 20 AWG (0.5 mm <sup>2</sup> ) to 16 AWG (1.5 mm <sup>2</sup> ) for one wire <b>Stranded:</b> 20 AWG (0.5 mm <sup>2</sup> ) to 18 AWG (1.0 mm <sup>2</sup> ) for two wires																			
<b>Cable Entry</b>	M20 x 1.5 threaded entrance Adapter supplied to convert M20 x 1.5 to 1/2" - 14 NPT threaded entrance																			
<b>Construction</b>	Aluminum alloy die cast																			
<b>Environmental Rating</b>	IP65																			
<b>Operating Conditions</b>	Temperature: -30 to +80 °C																			
<b>Weight</b>	SI-LM40MKH models: 0.34 kg SI-LM40MKV models: 0.31 kg																			
<b>Certifications</b>																				
<b>Contact Configuration and Switching Diagrams</b>	SI-LM40MKH..D models: SD018 (p. 674) SI-LM40MKH..E models: SD019 (p. 675)	SI-LM40MKH..F models: SD020 (p. 675) SI-LM40MKV.. models: SD021 and SD022 (p. 675)																		

# SI-LS42

## Plastic Locking Style Safety Interlock Switches



- Two locking mechanisms available including spring lock with energized solenoid release and energized solenoid lock with spring release
- Actuator head can be rotated in 90° increments to eight possible actuator positions: four vertical and four horizontal
- Design meets positive opening requirements for safety interlocks (IEC 60947-5-1)
- AC and DC voltage available

### SI-LS42 Safety Switches, 42 mm - Spring Lock and Solenoid Unlock

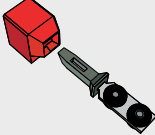
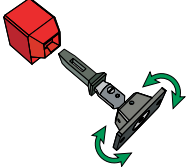
Actuator Type		Interlock	Contact(s)	Solenoid Voltage	Kit Model *
SI-QM-SSA Straight Rigid In-Line		SI-LS42DSG	Actuator Contacts: 1 NC & 1 NO	24 V ac/dc	SI-LS42DMSG
		SI-LS42WSG	Solenoid Monitor Contacts: 1 NC & 1 NO	110 V ac/ 230 V ac	SI-LS42WMSG
SI-QM-SMFA Flexible In-Line		SI-LS42DSG	Actuator Contacts: 1 NC & 1 NO	24 V ac/dc	SI-LS42DMSGF
		SI-LS42WSG	Solenoid Monitor Contacts: 1 NC & 1 NO	110 V ac/ 230 V ac	SI-LS42WMSGF



Multi-Directional

NC = Normally Closed Contact, NO = Normally Open Contact

\* A kit contains an interlock and actuator. Individual interlocks (without actuator) are for replacement purposes only. Contact factory for integral quick-disconnect (QD) and pigtail QD options.



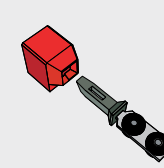
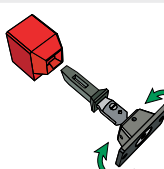
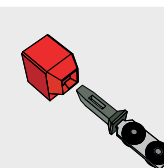
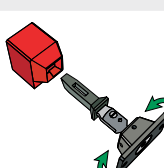
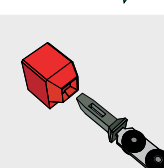
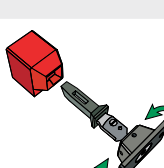



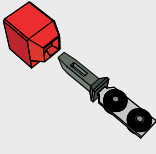

SI-LS42 Safety Switches, 42 mm - Spring Lock and Solenoid Unlock (cont'd)

Actuator Type		Interlock	Contact(s)	Solenoid Voltage	Kit Model *
SI-QM-SSA Straight Rigid In-Line		SI-LS42DSH	Actuator Contacts: 2 NC	24 V ac/dc	SI-LS42DMSH
		SI-LS42WSH	Solenoid Monitor Contacts: 1 NC & 1 NO	110 V ac/ 230 V ac	SI-LS42WMSH
SI-QM-SMFA Flexible In-Line		SI-LS42DSH	Actuator Contacts: 2 NC	24 V ac/dc	SI-LS42DMSHF
		SI-LS42WSH	Solenoid Monitor Contacts: 1 NC & 1 NO	110 V ac/ 230 V ac	SI-LS42WMSHF
SI-QM-SSA Straight Rigid In-Line		SI-LS42DSI	Actuator Contacts: 2 NC & 1 NO	24 V ac/dc	SI-LS42DMSI
		SI-LS42WSI	Solenoid Monitor Contact: 1 NC	110 V ac/ 230 V ac	SI-LS42WMSI
SI-QM-SMFA Flexible In-Line		SI-LS42DSI	Actuator Contacts: 2 NC & 1 NO	24 V ac/dc	SI-LS42DMSIF
		SI-LS42WSI	Solenoid Monitor Contacts: 1 NC	110 V ac/ 230 V ac	SI-LS42WMSIF
SI-QM-SSA Straight Rigid In-Line		SI-LS42DSJ	Actuator Contacts: 3 NC	24 V ac/dc	SI-LS42DMSJ
		SI-LS42WSJ	Solenoid Monitor Contact: 1 NC		
SI-QM-SMFA Flexible In-Line		SI-LS42DSJ	Actuator Contacts: 3 NC	24 V ac/dc	SI-LS42DMSJF
		SI-LS42WSJ	Solenoid Monitor Contact: 1 NC		

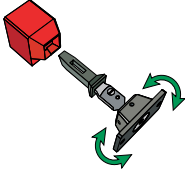
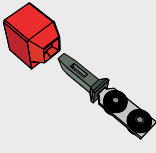
 Multi-Directional      NC = Normally Closed Contact, NO = Normally Open Contact

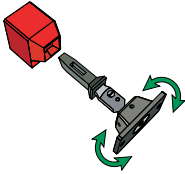
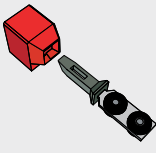
\* A kit contains an interlock and actuator. Individual interlocks (without actuator) are for replacement purposes only. Contact factory for integral quick-disconnect (QD) and pigtail QD options.

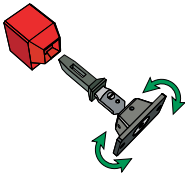
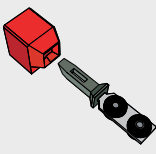
SI-LS42 Safety Switches, 42 mm - Solenoid Lock and Spring Unlock (cont'd)

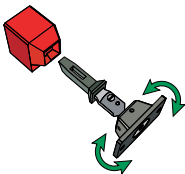
Actuator Type		Interlock	Contact(s)	Solenoid Voltage	Kit Model *
SI-QM-SSA Straight Rigid In-Line		SI-LS42DMG	Actuator Contacts: 1 NC & 1 NO	24 V ac/dc	SI-LS42DMMG
		SI-LS42WMG	Solenoid Monitor Contacts: 1 NC & 1 NO	110 V ac/ 230 V ac	SI-LS42WMMG
 SI-QM-SMFA Flexible In-Line		SI-LS42DMG	Actuator Contacts: 1 NC & 1 NO	24 V ac/dc	SI-LS42DMMGF
		SI-LS42WMG	Solenoid Monitor Contacts: 1 NC & 1 NO	110 V ac/ 230 V ac	SI-LS42WMMGF
SI-QM-SSA Straight Rigid In-Line		SI-LS42DMH	Actuator Contacts: 2 NC	24 V ac/dc	SI-LS42DMMH
		SI-LS42WMH	Solenoid Monitor Contacts: 1 NC & 1 NO	110 V ac/ 230 V ac	SI-LS42WMMH
 SI-QM-SMFA Flexible In-Line		SI-LS42DMH	Actuator Contacts: 2 NC	24 V ac/dc	SI-LS42DMMHF
		SI-LS42WMH	Solenoid Monitor Contacts: 1 NC & 1 NO	110 V ac/ 230 V ac	SI-LS42WMMHF
SI-QM-SSA Straight Rigid In-Line		SI-LS42DMI	Actuator Contacts: 2 NC & 1 NO	24 V ac/dc	SI-LS42DMMI
		SI-LS42WMI	Solenoid Monitor Contact: 1 NC	110 V ac/ 230 V ac	SI-LS42WMMI
 SI-QM-SMFA Flexible In-Line		SI-LS42DMI	Actuator Contacts: 2 NC & 1 NO	24 V ac/dc	SI-LS42DMMIF
		SI-LS42WMI	Solenoid Monitor Contact: 1 NC	110 V ac/ 230 V ac	SI-LS42WMMIF
SI-QM-SSA Straight Rigid In-Line		SI-LS42DMJ	Actuator Contacts: 3 NC	24 V ac/dc	SI-LS42DMMJ
		SI-LS42DMJ	Solenoid Monitor Contact: 1 NC	24 V ac/dc	SI-LS42DMMJF
 SI-QM-SMFA Flexible In-Line		SI-LS42DMJ	Actuator Contacts: 3 NC	24 V ac/dc	SI-LS42DMMJF
		SI-LS42DMJ	Solenoid Monitor Contact: 1 NC	24 V ac/dc	SI-LS42DMMJF

 Multi-Directional      NC = Normally Closed Contact, NO = Normally Open Contact

\* A kit contains an interlock and actuator. Individual interlocks (without actuator) are for replacement purposes only. Contact factory for integral quick-disconnect (QD) and pigtail QD options.

# SI-QM100

## Metal Locking Style Safety Interlock Switches



- Two locking mechanisms available including spring lock with energized solenoid release and energized solenoid lock with spring release
- Actuator head can be rotated in 90° increments to four possible actuator positions
- Design meets positive opening requirements for safety interlocks (IEC 60947-5-1)
- AC and DC voltage available

### SI-QM100 Safety Switches, 100 mm - Spring Lock and Solenoid Unlock

Actuator Type	Interlock	Contact(s)	Solenoid Voltage	Kit Model*
<b>SI-QM-SSA</b> Straight Rigid In-Line	SI-QM100DSG	Switching Contacts: 1 NC & 1 NO	24 V dc	SI-QM100DMSG
	SI-QM100ASG	Solenoid Monitor Contacts: 1 NC & 1 NO	120 V ac	SI-QM100AMSG
	SI-QM100DSH	Switching Contacts: 2 NC  Solenoid Monitor Contacts: 1 NC & 1 NO	24 V dc	SI-QM100DMSH

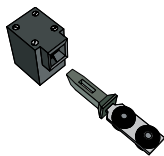

### SI-QM100 Safety Switches, 100 mm - Solenoid Lock and Spring Unlock

Actuator Type	Interlock	Contact(s)	Solenoid Voltage	Kit Model*
<b>SI-QM-SSA</b> Straight Rigid In-Line	SI-QM100DMG	Switching Contacts: 1 NC & 1 NO	24 V dc	SI-QM100DMMG
	SI-QM100AMG	Solenoid Monitor Contacts: 1 NC & 1 NO	120 V ac	SI-QM100AMMG

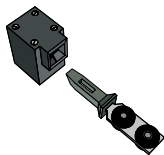

 Multi-Directional      NC = Normally Closed Contact, NO = Normally Open Contact

\* A kit contains an interlock and actuator. Individual interlocks (without actuator) are for replacement purposes only. Contact factory for integral quick-disconnect (QD) and pigtail QD options.

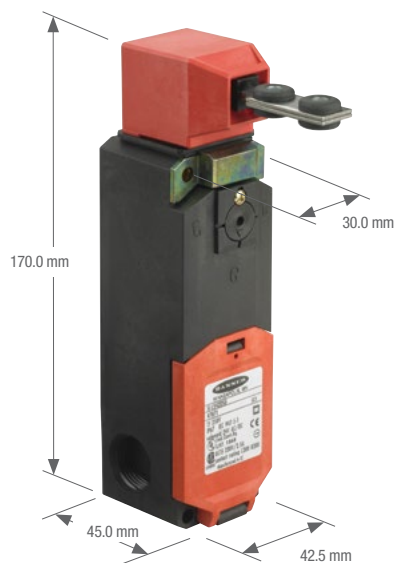

SI-LS42 Models  
(shown with rigid in-line actuator)

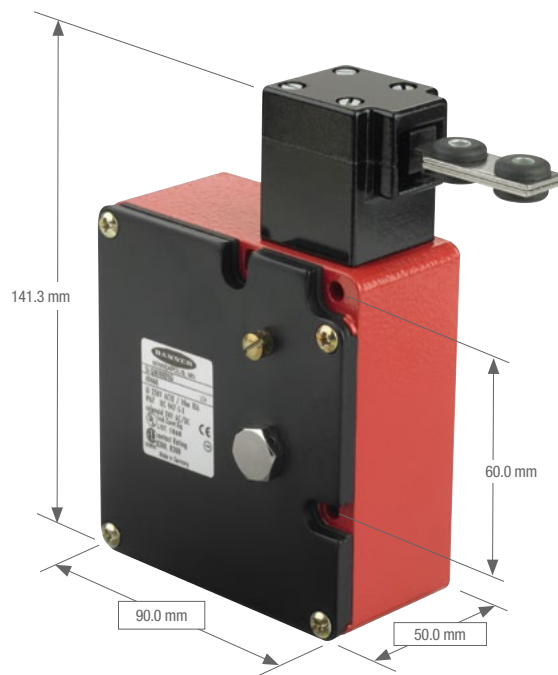

SI-QM100 Models  
(shown with rigid in-line actuator)



Locking Style Switches Specifications

<b>Contact Rating</b>	4A @ 250 V ac max. 2.5 kV max. transient tolerance NEMA A300 P300																
<b>European Rating</b>	<p><b>Utilization categories:</b> AC15 and DC13 (IEC 60947-5-1)  <b>Switches with 1 &amp; 2 contact pairs:</b> <math>U_n = 250V</math> ac  <b>SI-LS42 models:</b> <math>I_{th} = 2.5 A</math>  <b>SI-QM100 models:</b> <math>I_{th} = 10 A</math></p>	<table border="1"> <thead> <tr> <th colspan="3">40-60 Hz</th> </tr> <tr> <th><math>U_n</math> V</th> <th><math>I_n/AC-15</math> A</th> <th><math>I_n/DC-13</math> A</th> </tr> </thead> <tbody> <tr> <td>24</td> <td>10</td> <td>6</td> </tr> <tr> <td>110</td> <td>10</td> <td>1</td> </tr> <tr> <td>230</td> <td>6</td> <td>.4</td> </tr> </tbody> </table>	40-60 Hz			$U_n$ V	$I_n/AC-15$ A	$I_n/DC-13$ A	24	10	6	110	10	1	230	6	.4
40-60 Hz																	
$U_n$ V	$I_n/AC-15$ A	$I_n/DC-13$ A															
24	10	6															
110	10	1															
230	6	.4															
<b>Contact Material</b>	Silver-nickel alloy																
<b>Solenoid Power Consumption</b>	<b>SI-LS42 models:</b> 1.1 VA / Inrush 12 VA (0.2 sec) <b>SI-QM100 models:</b> 5.2 W																
<b>Maximum Actuator Speed</b>	1.5 m/second																
<b>Mechanical Life</b>	1 million operations																
<b>Minimum Actuator Engagement Radius</b>	<b>Rigid actuator:</b> 400 mm <b>Flexible actuator:</b> 150 mm																
<b>Actuation Extraction Force</b>	<b>SI-LS42 models:</b> 1500 N when locked <b>SI-QM100 models:</b> 1000 N when locked																
<b>Short Circuit Protection</b>	6 amp Slow Blow, 10 amp Fast Blow. Recommended external fusing or overload protection.																
<b>Wire Connections</b>	<b>SI-LS42 models:</b> 10 cage clamp elements 1.5 mm stranded max. / 16 AWG  <b>SI-QM100 models:</b> Screw terminals with pressure plates accept the following wire sizes – 16 AWG (1.5 mm <sup>2</sup> ) max. solid; 14 AWG (2.5 mm <sup>2</sup> ) max. stranded, 18 AWG (1 mm <sup>2</sup> ) when using all 11 terminals																
<b>Cable Entry</b>	M20 x 1.5 threaded entrance Adapter supplied to convert M20 x 1.5 to 1/2" - 14 NPT threaded entrance																
<b>Construction</b>	<b>SI-LS42 models:</b> Glass fiber-reinforced polyamide thermoplastic housing; UL 94-V0 rating <b>SI-QM100 models:</b> Aluminum die cast																
<b>Environmental Rating</b>	IP67																
<b>Operating Conditions</b>	<b>Temperature:</b> <b>SI-LS42 models:</b> -30 to +70 °C <b>SI-QM100 models:</b> -30 to +60 °C																
<b>Weight</b>	<b>SI-LS42 models:</b> 0.3 kg <b>SI-QM100 models:</b> 0.81 kg																
<b>Application Notes</b>	When rotating the actuator head, the actuator MUST BE FULLY ENGAGED. When using a model with solenoid locking, the lock mechanism will disengage upon solenoid power failure.																
<b>Certifications</b>																	
<b>Contact Configuration and Switching Diagrams</b>	<b>SI-LS42 models:</b> SD023, SD024, SD025 & SD026 (p. 675) <b>SI-QM100 models:</b> SD027 and SD028 (p. 676)																

SD001 - SI-HG63 Series

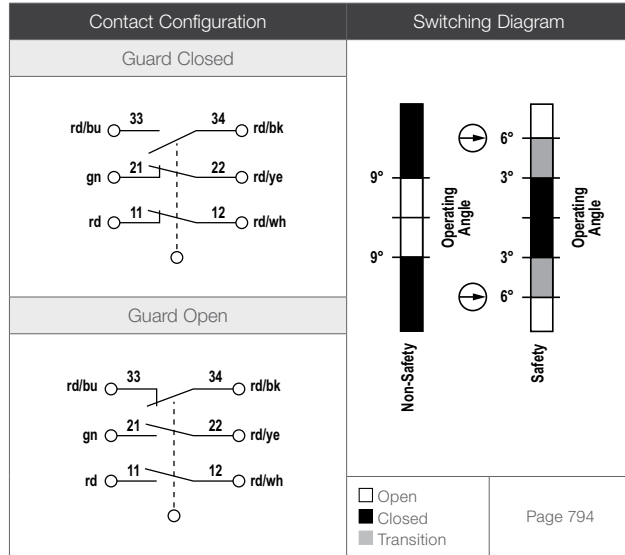

SD002 - SI-HG80 Series

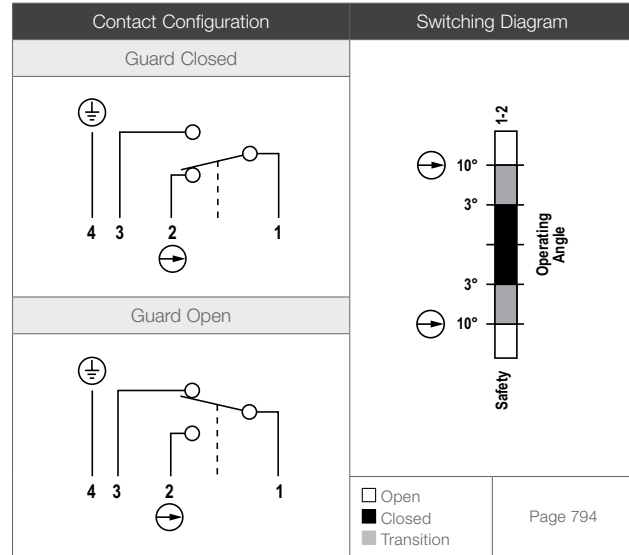

SD003 - SI-LS31HGD Series

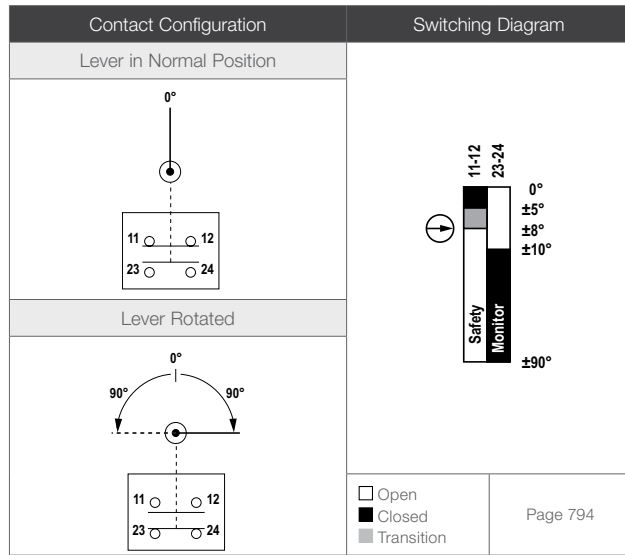

SD004 - SI-LS31HGE Series

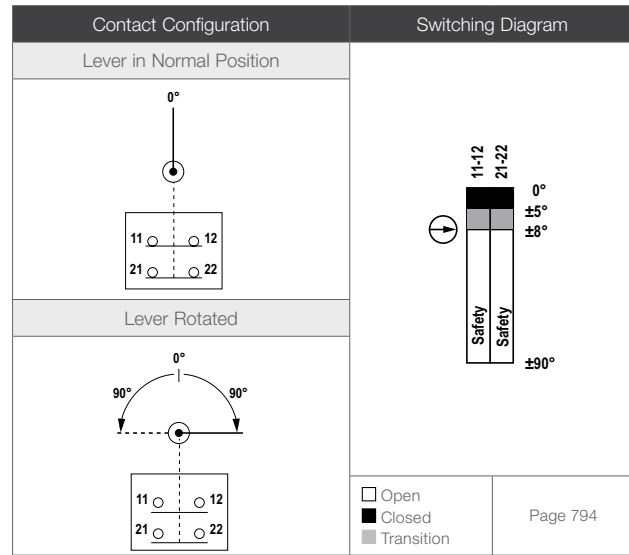

SD005 - SI-LS31HGRD Series

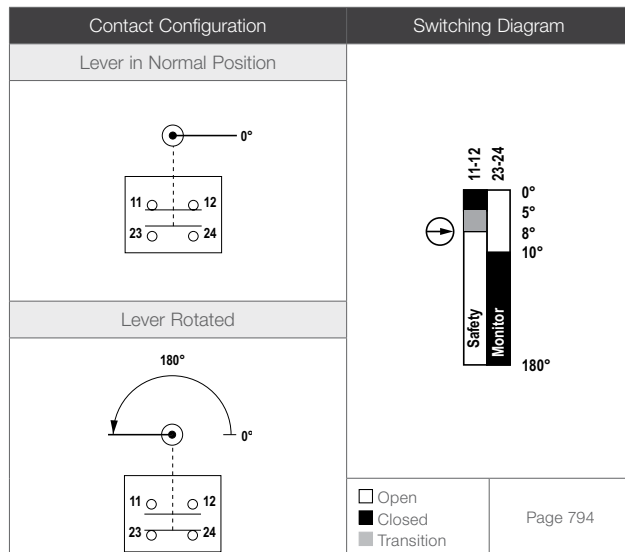

SD006 - SI-LS31HGREG Series

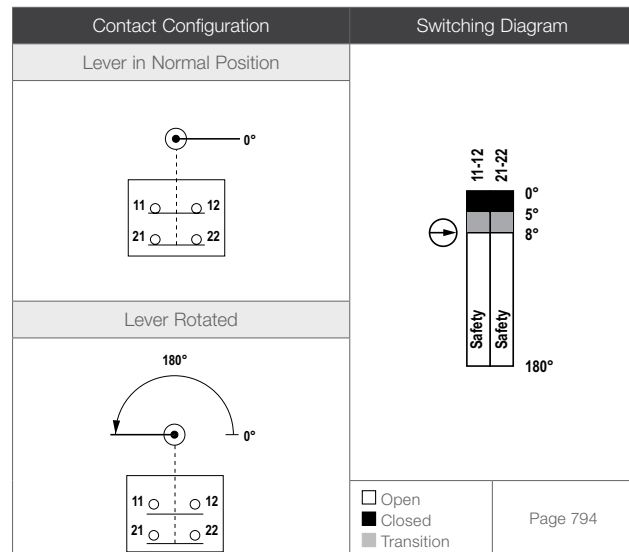

SD007 - SI-LS31HGLD Series

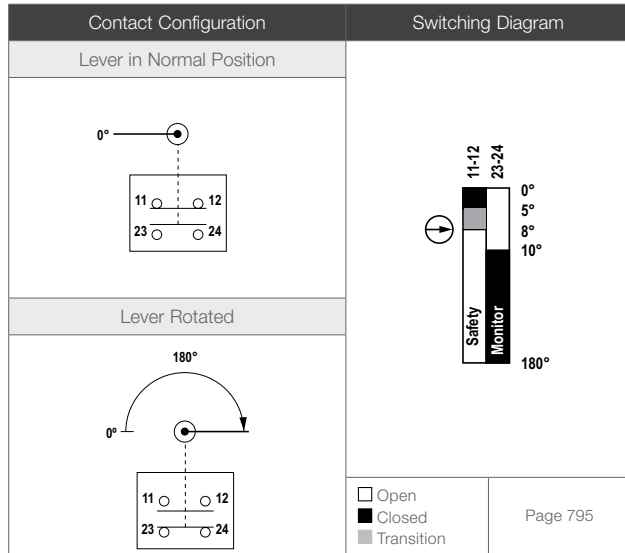

SD008 - SI-LS31HGLE Series

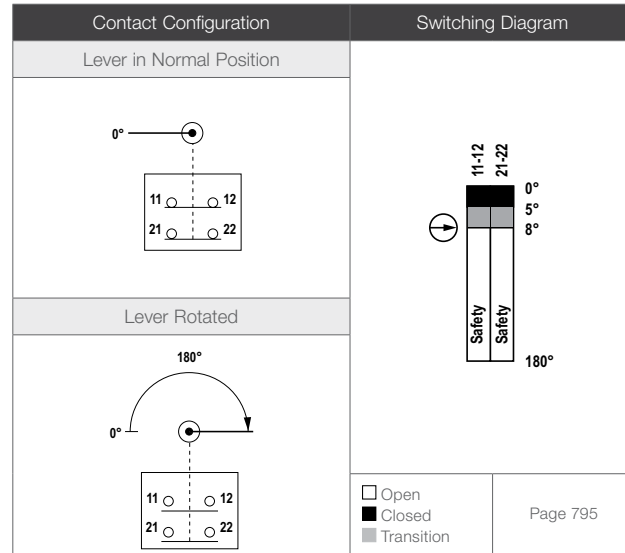

SD009 - SI-LS31RTD Series

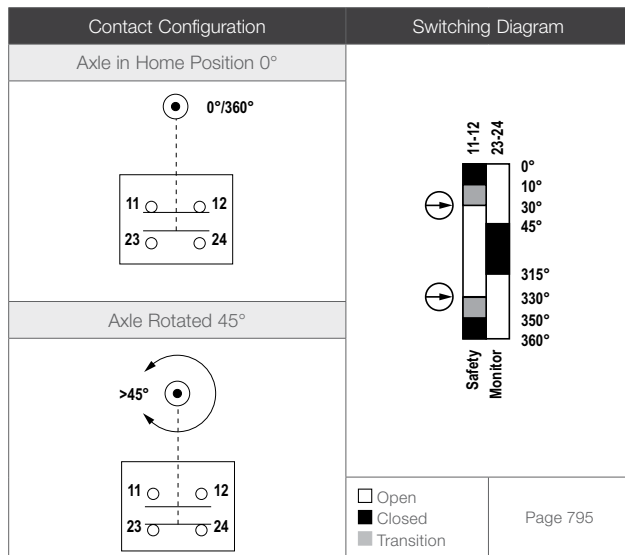

SD010 - SI-LS31RTE Series

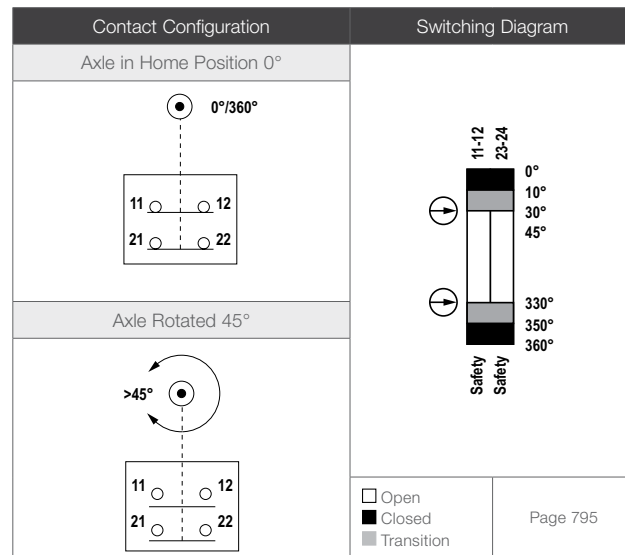

SD011 - SI-LS100 Series

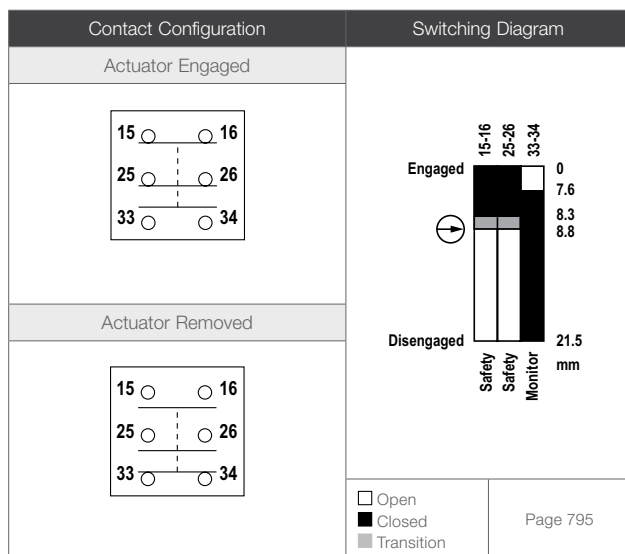

SD012 - SI-LS83..D Series

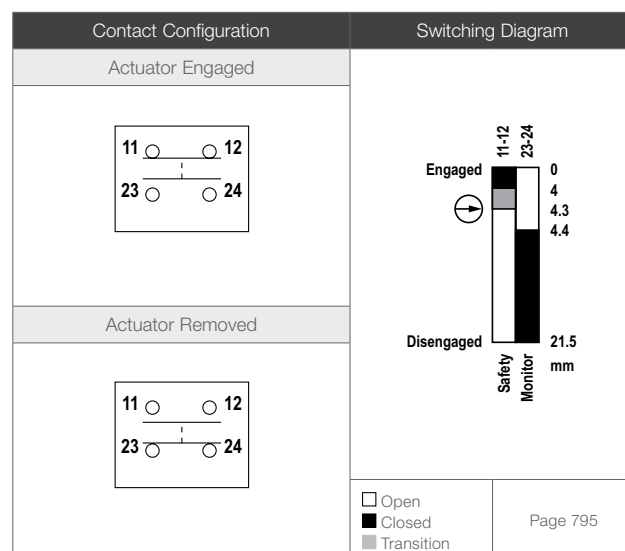

Continued on next page

SD013 - SI-LS83..E Series

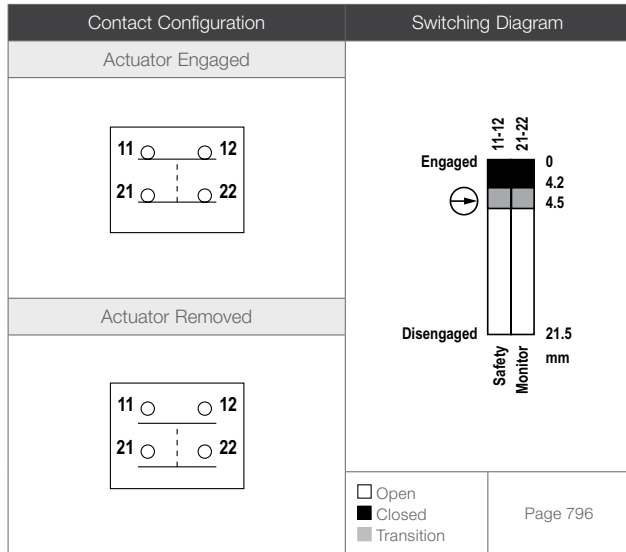

SD014 - SI-QS75 Series

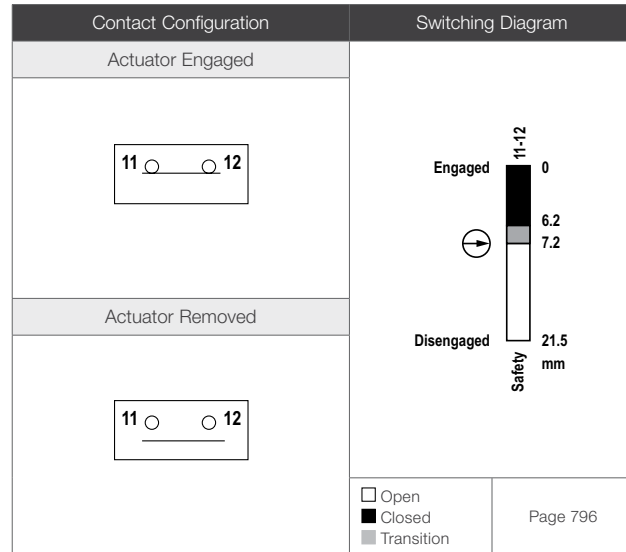

SD015 - SI-QS90MD Series

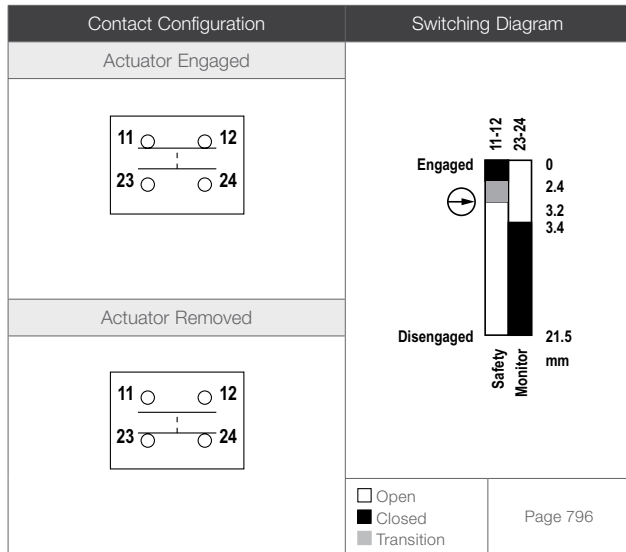

SD016 - SI-QS90ME Series

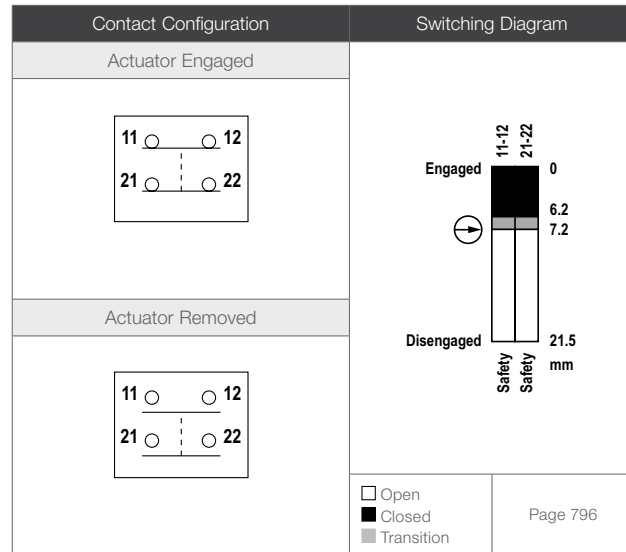

SD017 - SI-QS90MF Series

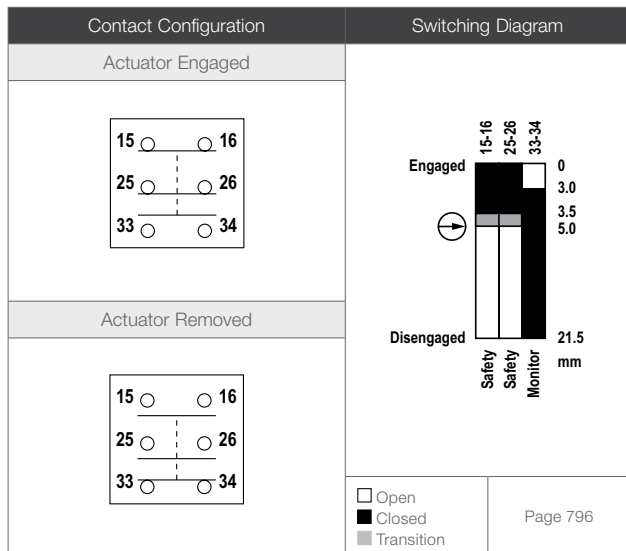

SD018 - SI-LM40MKHD Series

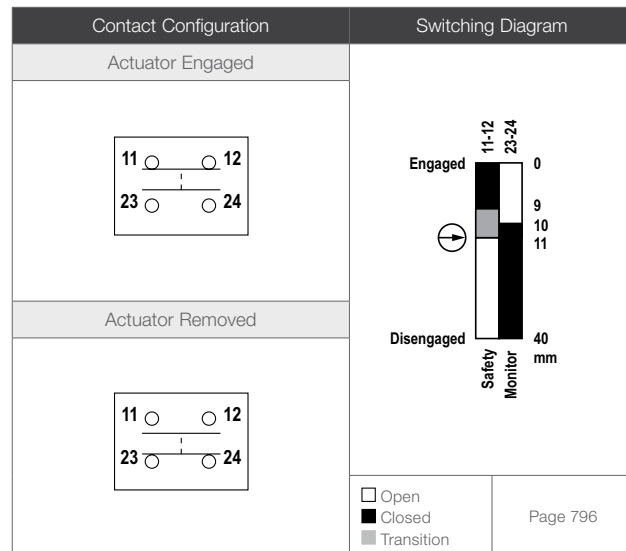

SD019 - SI-LM40MKHE Series

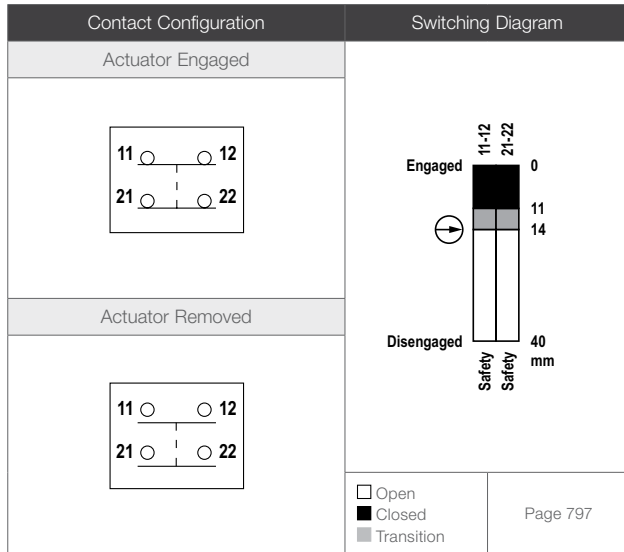

SD020 - SI-LM40MKHF Series

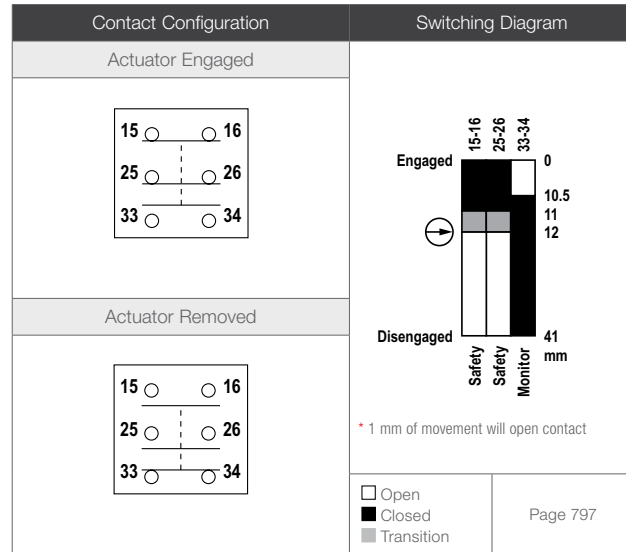

SD021 - SI-LM40MKVD Series

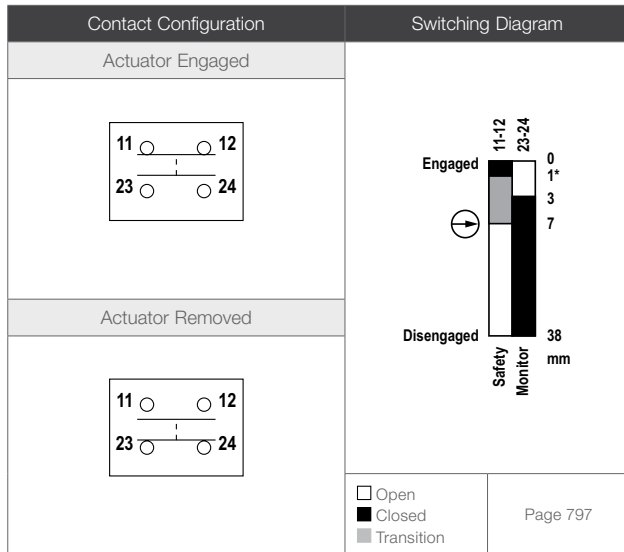

SD022 - SI-LM40MKVE Series

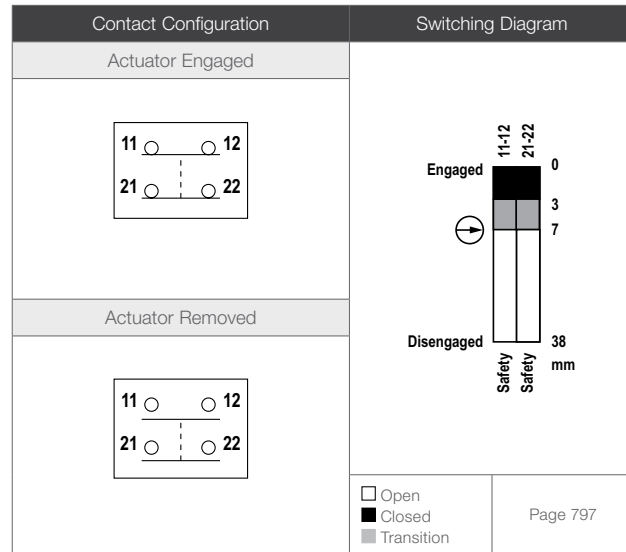

SD023 - SI-LS42..MSG/MMG Series

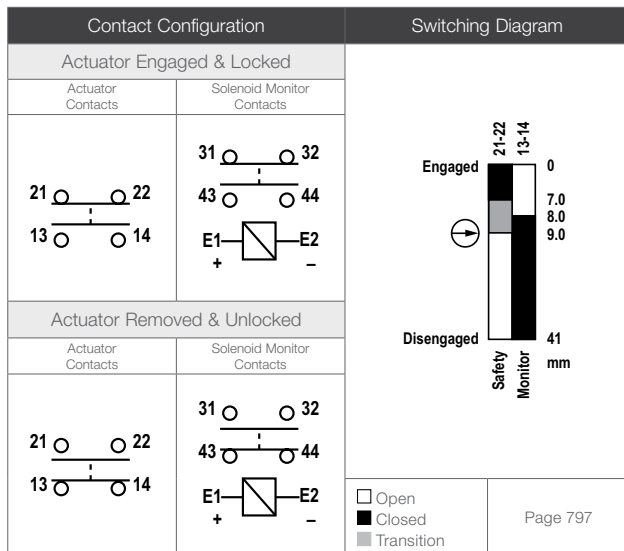

SD024 - SI-LS42..MSH/MMH Series

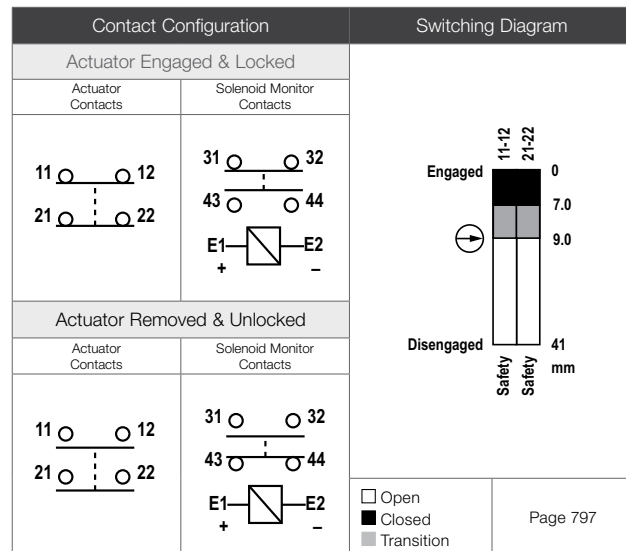

Continued on next page

SD025 - SI-LS42..MSI/MMI Series

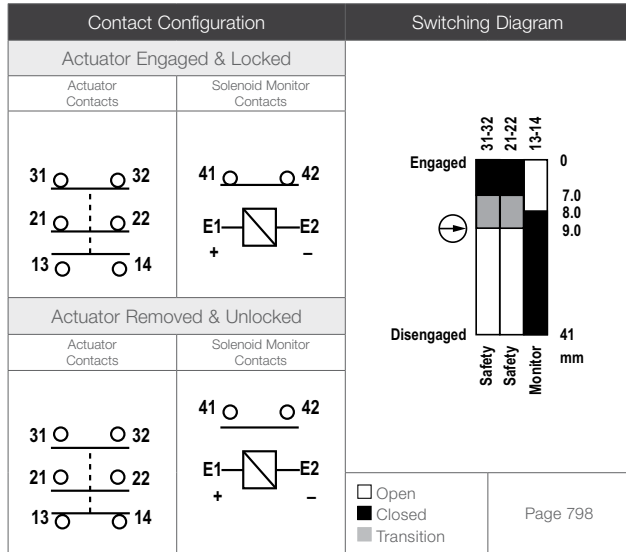

SD026 - SI-LS42..MSJ/MMJ Series

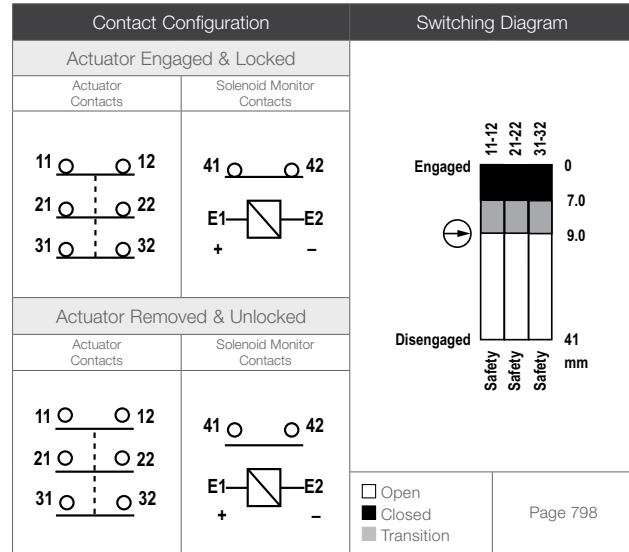

SD027 - SI-QM100..MSG/MMG Series

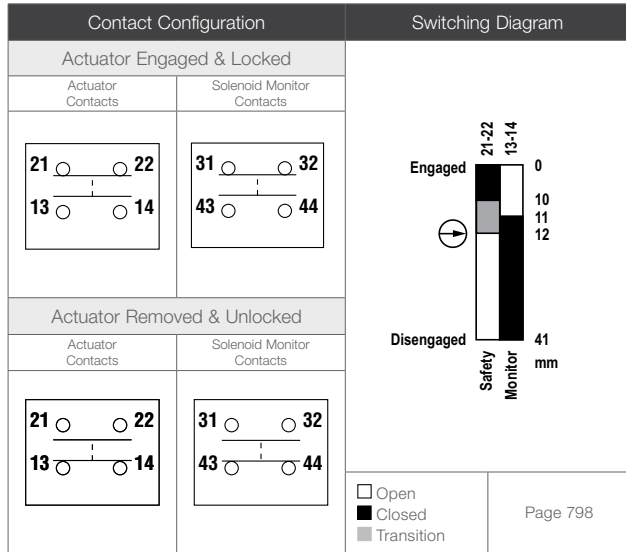

SD028 - SI-QM100..DMSH Series

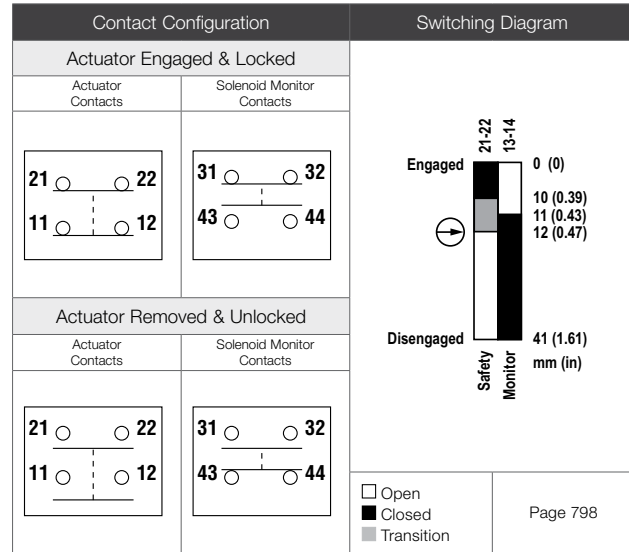





Safety Interlock Switches Replacement Parts

Used In	Description	Model*
SI-LM40MKH..D kits	Individual Interlock (without actuator)	SI-LM40KHD
SI-LM40MKH..E kits		SI-LM40KHE
SI-LM40MKH..F kits		SI-LM40KHF
SI-LM40MKVD kit		SI-LM40KVD
SI-LM40MKVE kit		SI-LM40KVE
SI-LS42MSG.. kits		SI-LS42DSG
SI-LS42WMSG.. kits		SI-LS42WSG
SI-LS42DMSH.. kits		SI-LS42DSH
SI-LS42WMSH.. kits		SI-LS42WSH
SI-LS42DMSI.. kits		SI-LS42DSI
SI-LS42WMSI.. kits		SI-LS42WSI
SI-LS42DMSJ.. kits		SI-LS42DSJ
SI-LS42DMMG.. kits		SI-LS42DMG
SI-LS42WMMG.. kits		SI-LS42WMG
SI-LS42DMMH.. kits		SI-LS42DMH
SI-LS42WMMH.. kits		SI-LS42WMH
SI-LS42DMMI.. kits		SI-LS42DMI
SI-LS42WMMI.. kits		SI-LS42WMI
SI-LS42DMMJ.. kits		SI-LS42DMJ
SI-LS100..F kits		SI-LS100F
SI-LS83..D kits		SI-LS83D
SI-LS83..E kits		SI-LS83E
SI-QM100MSG kit		SI-QM100DSG
SI-QM100AMSG kit		SI-QM100ASG
SI-QM100DMMG kit		SI-QM100DMG
SI-QM100AMMG kit		SI-QM100AMG
SI-QS75..C kits		SI-QS75C
SI-QS90..D kits		SI-QS90D
SI-QS90..E kits		SI-QS90E
SI-QS90..F kits		SI-QS90F

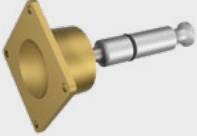
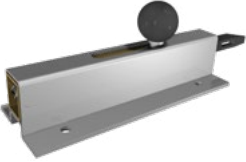



\* Kits with one safety interlock switch and an actuator are available (see pp. 806-821).

## Replacement Actuator Parts for Safety Interlock Switches

Description		Used With	Model
	<p>Flexible in-line, trumpet-style, metal actuator used for doors or covers where alignment is difficult to maintain. Flexes in all directions. Minimum engagement radius for hinged closures is 150 mm.</p>	<ul style="list-style-type: none"> <li>• SI-LM40MKV</li> </ul>	<p>SI-QM-90A</p>
	<p>Rigid in-line metal actuator used for doors or covers. Slide-bolt design for use in heavy-duty applications where alignment is difficult to maintain.</p>	<ul style="list-style-type: none"> <li>• SI-LM40MKH</li> <li>• SI-LS42</li> <li>• SI-QM100</li> </ul>	<p>SI-QM-SB</p>
	<p>Flexible in-line metal actuator used for doors or covers where alignment is difficult to maintain. Flexes in all directions. Minimum engagement radius for hinged closures is 150 mm.</p>	<ul style="list-style-type: none"> <li>• SI-LM40MKH</li> <li>• SI-LS42</li> <li>• SI-QM100</li> </ul>	<p>SI-QM-SMFA</p>
	<p>Rigid in-line metal actuator used for doors or covers with accurate alignment, such as sliding doors. Minimum engagement radius for hinged closures is 400 mm.</p>	<ul style="list-style-type: none"> <li>• SI-LM40MKH</li> <li>• SI-LS42</li> <li>• SI-QM100</li> </ul>	<p>SI-QM-SSA</p>
	<p>High-extraction-force adapter for particularly heavy or large doors. Adjustable from 50 to 100 Newtons (force). Used only for switches with in-line actuator SI-QS-SSA.</p>	<ul style="list-style-type: none"> <li>• SI-QS75</li> <li>• SI-QS90</li> </ul>	<p>SI-QS-100</p>





Replacement Actuator Parts for Safety Interlock Switches (cont'd)

Description		Used With	Model
	<p>Rigid in-line metal (die-cast steel) actuator for doors or covers with a radius of 150 mm or greater.</p>	<ul style="list-style-type: none"> <li>• SI-QS75 (high-force)</li> <li>• SI-QS90 (high-force)</li> </ul>	<p>SI-QS-SSA</p>
	<p>Rigid in-line metal (stamped stainless steel) actuator used for doors or covers with accurate alignment, such as sliding doors. Minimum engagement radius for hinged closures is 150 mm.</p>	<ul style="list-style-type: none"> <li>• SI-LS83</li> <li>• SI-LS100</li> </ul>	<p>SI-QS-SSA-2</p>
	<p>Rigid in-line metal (stamped stainless steel) actuator used for doors or covers with accurate alignment, such as sliding doors. Right-angle mounting flange. Minimum engagement radius for hinged closures is 150 mm.</p>	<ul style="list-style-type: none"> <li>• SI-LS83</li> <li>• SI-LS100</li> </ul>	<p>SI-QS-SSA-3</p>
	<p>Rigid in-line metal (stamped stainless steel) actuator for doors or covers with a radius of 150 mm or greater.</p>	<ul style="list-style-type: none"> <li>• SI-QS75</li> <li>• SI-QS90</li> </ul>	<p>SI-QS-SSA-4</p>
	<p>Flexible in-line metal (die-cast steel) actuator for hinged doors with a radius of 50 mm or greater. Flexes in all directions. Minimum engagement radius for hinged closures is 150 mm.</p>	<ul style="list-style-type: none"> <li>• SI-LS83</li> <li>• SI-LS100</li> <li>• SI-QS75</li> <li>• SI-QS90</li> </ul>	<p>SI-QS-SSU</p>
<p>Replacement terminal cover</p>		<ul style="list-style-type: none"> <li>• SI-LS42</li> </ul>	<p>SI-LS42-COVER</p>
<p>Tamper Proof Screw (One way)</p>		<ul style="list-style-type: none"> <li>• SI-LS42</li> </ul>	<p>SI-LS42-SCREW OW</p>



## Two-Hand Control

Modules monitor the output of each Banner STB self-checking touch button or electromechanical button and deenergizes when the machine operator removes one or both hands from the buttons, providing protection for the worker actuating the hand controls.

Series	Description	Protection Rating	Power Supply
	<p><b>Two Hand-Control Module</b> page 682</p>	<p>Category 4 (module); Type IIIC</p>	<p>24 V ac/dc, 115 V ac/24 V dc or 230 V ac/24 V dc, depending on model</p>
	<p><b>STB Buttons</b> page 686</p>	<p>Dependent on controller/module</p>	<p>10 - 30 V dc or 20-30 V ac/dc depending on model</p>
	<p><b>Run Bar</b> page 690</p>	<p>Dependent on controller/module</p>	<p>10 to 30 V dc</p>

# DUO-TOUCH® SG

## Two-Hand Control Modules



- Modules work with existing electromechanical palm buttons or with Banner's STB Self-Checking Touch Buttons to create a complete, ergonomic two-hand control system
- Anti-tiedown logic requires both touch buttons to be activated within one-half second or less of each other
- Modules easily interface with DUO-TOUCH® Run Bars with STBs for an economical, convenient means for actuation
- Designed to meet OSHA/ANSI Control Reliability requirements and Category 4 per ISO 13849-1 (EN 954-1) and functional Type IIIC Two-Hand Control per ISO 13851 (EN 574)
- AC modules have a complementary DC power supply to power the STB button
- Relay outputs are capable of reliably switching low or high current applications (depending on model)

### DUO-TOUCH® SG Two-Hand Control Modules



Supply Voltage	Inputs	Safety Outputs	Output Rating	Auxiliary Outputs	Muting	Terminals	Model
24 V ac/dc	2 STB*	2 NO	6 amps	—	—	Removable	AT-FM-10K
115 V ac/24 V dc	2 STB*	4 NO	6 amps	1 NPN, 1 PNP & 1 NC	—	Removable	AT-GM-13A
230 V ac/24 V dc	2 STB*	4 NO	6 amps	1 NPN, 1 PNP & 1 NC	—	Removable	AT-HM-13A

NC = Normally Closed, NO = Normally Open

\* May also use two electromechanical push buttons, each with one normally open (NO) and one normally closed (NC) contact (Form C). See data sheets for details.

NOTE: Kits are available which include one DUO-TOUCH SG Safety Module and two STB Touch Buttons. STB Touch Buttons are also available separately. See page 686.

DUO-TOUCH® SG Kits — Solid-State STB Touch Buttons (Meets Category IIIC)

Kit Components						Kit
DUO-TOUCH® SG Safety Module	STB Touch Buttons (see page 686)	Supply Voltage	Safety Outputs	Auxiliary Outputs	Connection	Includes 2 STB Touch Buttons & a DUO-TOUCH® SG Safety Module
 <b>AT-FM-10K</b>	STBVP6	24 V ac/dc	2 NO	-	2 m	<b>ATK-VP6</b>
	STBVP6Q				4-Pin Mini QD	<b>ATK-VP6Q</b>
	STBVP6Q5				4-Pin Euro QD	<b>ATK-VP6Q5</b>
 <b>AT-GM-13A</b>	STBVP6	115 V ac/ 24 V dc	4 NO	1 NPN, 1 PNP & 1 NC	2 m	<b>ATGMK-VP6</b>
	STBVP6Q				4-Pin Mini QD	<b>ATGMK-VP6Q</b>
	STBVP6Q5				4-Pin Euro QD	<b>ATGMK-VP6Q5</b>
 <b>AT-HM-13A</b>	STBVP6	230 V ac/ 24 V dc	4 NO	1 NPN, 1 PNP & 1 NC	2 m	<b>ATHMK-VP6</b>
	STBVP6Q				4-Pin Mini QD	<b>ATHMK-VP6Q</b>
	STBVP6Q5				4-Pin Euro QD	<b>ATHMK-VP6Q5</b>

NC = Normally Closed, NO = Normally Open

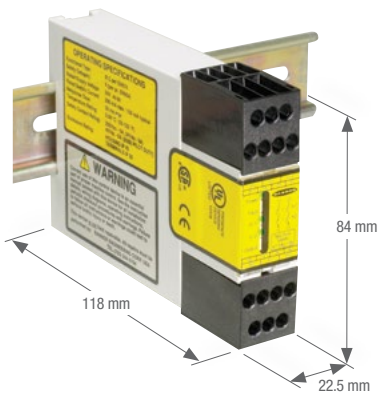



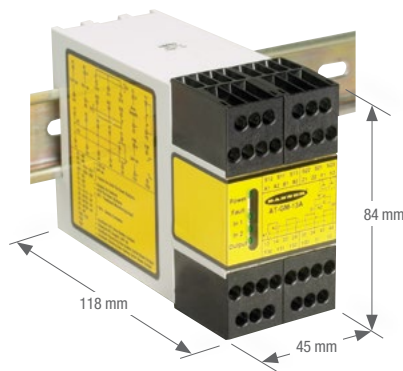





AT-FM-10K Model



AT-GM-13A & AT-HM-13A Models (AT-GM-13A shown)

## DUO-TOUCH® SG AT-FM-10K Modules Specifications

Supply Voltage and Current	24 V dc $\pm 15\%$ @ 150 mA (use a SELV-rated supply according to EN IEC 60950, NEC Class 2) 24 V ac $\pm 15\%$ @ 150 mA, 50-60 Hz $\pm 5\%$ (use an NEC Class 2-rated transformer) To comply with UL and CSA standards, the installation's isolated secondary power supply circuit must incorporate a method to limit the overvoltage to 0.8 kV.																
Supply Protection Circuitry	Protected against transient voltages and reverse polarity																
Overvoltage Category	<b>Output relay contact voltage of 1 V to 150 V ac/dc:</b> Category III <b>Output relay contact voltage of 151 V to 250 V ac/dc:</b> Category II (Category III, if appropriate overvoltage reduction is provided, as described in data sheet.)																
Pollution Degree	2																
Safety Outputs	<p>Each normally open output channel is a series connection of contacts from two forced-guided (mechanically linked) relays, K1-K2.</p> <p><b>Contacts:</b> AgNi, 5 <math>\mu</math>m gold-plated</p> <p><b>Low Current Rating:</b> The 5 <math>\mu</math>m gold-plated contacts allow the switching of low current/low voltage. In these low-power applications, multiple contacts can also be switched in series (e.g., "dry switching"). To preserve the gold plating on the contacts, do not exceed the following max. values at any time</p> <table border="0"> <tr> <td><b>Min. voltage:</b> 1V ac/dc</td> <td><b>Max. voltage:</b> 60 V</td> </tr> <tr> <td><b>Min. current:</b> 5 mA ac/dc</td> <td><b>Max. current:</b> 300 mA</td> </tr> <tr> <td><b>Min. power:</b> 5 mW (5 mVA)</td> <td><b>Max. power:</b> 7 W (7 VA)</td> </tr> </table> <p><b>High Current Rating:</b> If higher loads must be switched through one or more of the contacts, the minimum and maximum values of the contact(s) changes to:</p> <table border="0"> <tr> <td rowspan="2"></td> <td><b>Minimum</b></td> <td><b>Maximum</b></td> </tr> <tr> <td><b>Voltage:</b> 15 V ac/dc <b>Current:</b> 30 mA ac/dc <b>Power:</b> 0.45 W (0.45 VA)</td> <td>250 V ac/dc / 24 V dc, 6 A resistive B300, R300 per UL508</td> </tr> <tr> <td rowspan="2"></td> <td><b>Minimum</b></td> <td><b>Maximum</b></td> </tr> <tr> <td><b>Voltage:</b> 15 V ac/dc <b>Current:</b> 30 mA ac/dc <b>Power:</b> 0.45 W (0.45 VA)</td> <td>250 V ac/dc / 24 V dc, 6 A resistive IEC 60947-5-1 AC15 230 V ac, 3A; DC-13: 24 V dc, 2A</td> </tr> </table> <p><b>Mechanical life:</b> 20,000,000 operations <b>Electrical life (switching cycles of the output contacts, resistive load):</b> 150,000 cycles @ 900 VA; 1,000,000 cycles @ 250 VA; 2,000,000 cycles @ 150 VA; 5,000,000 cycles @ 100 VA NOTE: Transient suppression is recommended when switching inductive loads. Install suppressors across load. Never install suppressors across output contacts.</p>	<b>Min. voltage:</b> 1V ac/dc	<b>Max. voltage:</b> 60 V	<b>Min. current:</b> 5 mA ac/dc	<b>Max. current:</b> 300 mA	<b>Min. power:</b> 5 mW (5 mVA)	<b>Max. power:</b> 7 W (7 VA)		<b>Minimum</b>	<b>Maximum</b>	<b>Voltage:</b> 15 V ac/dc <b>Current:</b> 30 mA ac/dc <b>Power:</b> 0.45 W (0.45 VA)	250 V ac/dc / 24 V dc, 6 A resistive B300, R300 per UL508		<b>Minimum</b>	<b>Maximum</b>	<b>Voltage:</b> 15 V ac/dc <b>Current:</b> 30 mA ac/dc <b>Power:</b> 0.45 W (0.45 VA)	250 V ac/dc / 24 V dc, 6 A resistive IEC 60947-5-1 AC15 230 V ac, 3A; DC-13: 24 V dc, 2A
<b>Min. voltage:</b> 1V ac/dc	<b>Max. voltage:</b> 60 V																
<b>Min. current:</b> 5 mA ac/dc	<b>Max. current:</b> 300 mA																
<b>Min. power:</b> 5 mW (5 mVA)	<b>Max. power:</b> 7 W (7 VA)																
	<b>Minimum</b>	<b>Maximum</b>															
	<b>Voltage:</b> 15 V ac/dc <b>Current:</b> 30 mA ac/dc <b>Power:</b> 0.45 W (0.45 VA)	250 V ac/dc / 24 V dc, 6 A resistive B300, R300 per UL508															
	<b>Minimum</b>	<b>Maximum</b>															
	<b>Voltage:</b> 15 V ac/dc <b>Current:</b> 30 mA ac/dc <b>Power:</b> 0.45 W (0.45 VA)	250 V ac/dc / 24 V dc, 6 A resistive IEC 60947-5-1 AC15 230 V ac, 3A; DC-13: 24 V dc, 2A															
Output Response Time	35 milliseconds maximum																
Input Requirements	Outputs from actuating devices must each be capable of switching 25 mA @ 24 V dc (nominal).																
Simultaneity Monitoring Period	$\leq 500$ milliseconds																
Status Indicators	<table border="0"> <tr> <td><b>4 green LEDs:</b></td> <td><b>1 red LED:</b></td> </tr> <tr> <td>Power ON</td> <td>Fault</td> </tr> <tr> <td>Input 1 energized</td> <td></td> </tr> <tr> <td>Input 2 energized</td> <td></td> </tr> <tr> <td>Output</td> <td></td> </tr> </table>	<b>4 green LEDs:</b>	<b>1 red LED:</b>	Power ON	Fault	Input 1 energized		Input 2 energized		Output							
<b>4 green LEDs:</b>	<b>1 red LED:</b>																
Power ON	Fault																
Input 1 energized																	
Input 2 energized																	
Output																	
Construction	Polycarbonate housing																
Environmental Rating	IEC IP20																
Mounting	Mounts to standard 35 mm DIN rail track. Safety Module must be installed inside an enclosure rated NEMA 3 (IP54), or better.																
Vibration Resistance	10 to 55 Hz @ 0.35 mm displacement per IEC 60068-2-6																
Operating Conditions	<b>Temperature:</b> 0° to +50 °C <b>Relative humidity:</b> 90% @ +50 °C (non-condensing)																
Design Standards	 : Cat. 4 PL e, per EN ISO 13849-1; SIL 3 per IEC 61508 and IEC 62061; Type IIIc per ISO 13851 (EN574) (when used with STBs or hard contacts)																
Certifications	  <b>PRESS CONTROL 8N35</b>																

## DUO-TOUCH® SG AT-..M-13A Modules Specifications

Supply Voltage and Current	<b>AT-GM-13A:</b> 115 V ac, ±15%; 50/60 Hz & 24 V dc, ±15%, 10% max. ripple <b>AT-HM-13A:</b> 230 V ac, ±15%; 50/60 Hz & 24 V dc, ±15%, 10% max. ripple	
Power Consumption	Approx. 4 W/7 VA	
Supply Protection Circuitry	Protected against transient voltages and reverse polarity	
Safety Outputs (including Auxiliary NC output 51/52)	Outputs (K1 and K2): four redundant (total of eight) forced-guided safety relay contacts <b>Contact ratings:</b> <b>Min. voltage:</b> 15V ac/dc <b>Max. voltage:</b> 250 V ac or 250 V dc <b>Min. current:</b> 30 mA <b>Max. current:</b> 6A ac or dc (resistive load) <b>Min. power:</b> 0.45 VA (0.45 W) <b>Max. power:</b> 1500 VA (200 W) <b>Mechanical life:</b> 50,000,000 operations <b>Electrical life:</b> 150,000 cycles (typically @ 1.5 kVA switching power)	
	NOTE: Transient suppression is recommended when switching inductive loads. Install suppressors across load. Never install suppressors across output contacts.	
Auxiliary Supply Voltage (for Solid-State outputs)	24 V dc @ 1A (between Y30 & Y33)	
Auxiliary Solid-State Output Current	500 mA max., short circuit protected (Y32 or Y33)	
Output Response Time	35 milliseconds max. ON/OFF	
Input Requirements	Outputs from actuating devices (1 NO and 1 NC) must each be capable of switching 20 mA @ 12 V dc.	
Simultaneity Monitoring Period	≤ 500 milliseconds	
Z1/Z2 Courtesy Voltage	24 V dc @ 150 mA (for STB button power)	
External Device Monitoring (EDM)	One pair of terminals (Y1 and Y2) are provided to monitor the state of external devices controlled by the safety outputs. Each device must be capable of switching 15 to 30V dc at 10-50 mA.	
Status Indicators	<b>4 green LEDs:</b> <b>1 red LED:</b> Power ON    Fault Input 1 energized Input 2 energized Output	
Environmental Rating	Polycarbonate. Rated NEMA 1; IP20	
Mounting	Mounts to standard 35 mm DIN rail track. Safety Module must be installed inside an enclosure rated NEMA 3 (IP54), or better.	
Vibration Resistance	10 to 55 Hz @ 0.35 mm displacement per IEC 60068-2-6	
Operating Conditions	<b>Temperature:</b> 0 to +50 °C <b>Relative humidity:</b> 90% @ +50 °C (non-condensing)	
Design Standards	Designed to comply with Category 4 per ISO 13849-1 (EN 954-1); Type III C per ISO 13851 (EN 574)	
Certifications		<b>Important Notice:</b> European Community Machinery Directive 2006/42/EC The DUO-TOUCH SG AT-..M-13A Two-Hand Control Modules comply with Machinery Directive 98/37/EC, but not with Machinery Directive 2006/42/EC. Therefore, these modules can only be installed as a replacement component within the European Union (EU). For more information, please see <a href="http://www.bannerengineering.com/144763">www.bannerengineering.com/144763</a> or call 1-888-373-6767.

# Self-Checking Touch Buttons (STB)



## Two-Hand Control

- Provide the highest level of safety for two-hand control input devices via redundant microprocessor and optical path
- Features ergonomic design to prevent repetitive motion stress by responding to a finger blocking light rather than to pressure
- Includes yellow field cover to prevent unintended switching
- For safety applications, STB buttons must be used with DUO-TOUCH® SG Two-Hand control modules, Safety Controller or comparable control Type IIIC Two-Hand system

### STB Self-Checking Buttons – Solid-State Outputs, 10-30 V dc

Connection	Upper Housing	Solid-State Outputs	Models
2 m	Polyetherimide	2 Complementary PNP (1 ON, 1 OFF)	STBVP6
4-Pin Mini QD			STBVP6Q
4-Pin Euro QD			STBVP6Q5

### STB Self-Checking Buttons – e/m Relay Outputs, 20-30 V ac/dc

Connection	Upper Housing	Relay Outputs	Models
2 m	Polyetherimide	2 Complementary SPST (1 NC, 1 NO)	STBVR81
5-Pin Mini QD			STBVR81Q
5-Pin Euro QD			STBVR81Q6

For more specifications see page 689.

 Connection options: A model with a QD requires a mating cordset.

For 9 m cable, add suffix W/30 to the 2 m model number (example, STBVP6 W/30).



## INTERLOCK SWITCHES

## TWO-HAND CONTROL

## LASER SCANNERS

## MODULES



**Euro-Style to Flying Leads**  
Straight connector models listed; for right-angle, add **RA** to the end of the model number (example, **MQDC-406RA**)

4-Pin

**MQDC-406**  
2 m (6.5')  
**MQDC-415**  
5 m (15')  
**MQDC-430**  
9 m (30')

5-Pin

**MQDC1-406**  
2 m (6.5')  
**MQDC1-415**  
5 m (15')  
**MQDC1-430**  
9 m (30')



**Mini-Style**  
Straight connector models only

4-Pin

**MBCC-406**  
2 m (6.5')  
**MBCC-412**  
4 m (12')  
**MBCC-415**  
9 m (30')

5-Pin

**MBCC-506**  
2 m (6.5')  
**MBCC-512**  
4 m (12')  
**MBCC-515**  
9 m (30')

*Additional cordset information is available.  
See page 758*



SMB30A



SMB30MM

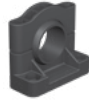

SMB30SC



SMBAMS30P



SMBAMS30RA

*Additional bracket information is available.  
See page 737*



Field Covers

**OTC-1-BK**  
Black  
**OTC-1-GN**  
Green  
**OTC-1-RD**  
Red  
**OTC-1-YW**  
Yellow

**OTCL-1-BK**  
Black  
**OTCL-1-GN**  
Green  
**OTCL-1-RD**  
Red  
**OTCL-1-YW**  
Yellow



STB models



STB models with cover

## STB Self-Checking Buttons Specifications

Supply Voltage and Current	<b>STBVP6 Models:</b> 10 to 30 V dc @ 75 mA, typical <b>STBVR81 Models:</b> 20 to 30 V ac/dc or 20 V to 30 V ac (peak-to-peak value), (50/60 Hz ± 5%) @ 75 mA
Supply Protection Circuitry	Protected against transient voltages and reverse polarity
Output Configuration	<b>STBVP6 Models:</b> Complementary PNP (sourcing) open-collector transistors <b>STBVR81 Models:</b> Complementary electromechanical relay
Output Rating	<b>STBVP6 Models (solid-state outputs):</b> Max. load: 150 mA ON-state saturation voltage: +V(supply) -1.5V OFF-state leakage current: less than 1 µA  <b>STBVR81 Models (electromechanical relay):</b> Max. switching voltage: 125 V dc/150 V ac Max. switching current: 1A @ 24 V dc; 0.4A @ 125V ac (resistive loads) Max. resistive load power: 24 W dc; 50 VA ac Mechanical life of relay: 109 cycles Electrical life of relay: 1.5 x 10 <sup>5</sup> cycles at 1 amp 24 V resistive
Output Protection	All models protected against false pulse on power-up. Models with solid-state outputs have overload and short-circuit protection.
Output Response Time	20 milliseconds ON/OFF
Indicators	<b>2 green LED indicators:</b> Power: ON –power applied OFF –power off Output/fault: ON –button is activated OFF –button is deactivated Flashing –internal fault or blocked button on power-up detected
Construction	Totally encapsulated, non-metallic enclosure. Black Polyetherimide (PEI) upper housing; fiber-reinforced PBT polyester base. Electronics fully epoxy-encapsulated. Supplied with polypropylene (TP) field cover.
Environmental Rating	Meets NEMA standards 1, 3, 4, 4X, 12 and 13; IP66
Connections	PVC-jacketed 2 m cables standard on integral-cable kits; QD fitting, depending on model. Accessory QD mating cordsets required for QD models. QD cordsets are ordered separately. <b>STBVP6:</b> 4-wire (4-pin Mini-style QD, add suffix <b>Q</b> or 4-pin Euro-style QD, add suffix <b>Q5</b> ) <b>STBVR81:</b> 5-wire (5-pin Mini-style QD, add suffix <b>Q</b> or 5-pin Euro-style QD, add suffix <b>Q6</b> ) Integral 9 m cables are also available by adding suffix <b>W/30</b> to the 2 m model number.
Ambient Light Immunity	Up to 100,000 lux
Applicable Agency Standards	(Used with an AT-FM-10K module or an SC22-3 Safety Controller) Analysis of measures for fault avoidance and fault control according to SIL3 (IEC 61508 and IEC 62061) and Category 4 (EN ISO 13849-1) passes EMI/RFI test levels as specified in IEC61496 and IEC62061.
Operating Conditions	<b>Temperature:</b> 0° to +50 °C <b>Relative humidity:</b> 90% @ +50 °C (non-condensing)
Application Notes	<b>Environmental considerations for models with Polyetherimide (PEI) upper housings:</b> The Polyetherimide upper housing will become brittle with prolonged exposure to outdoor sunlight. Window glass effectively filters ultraviolet light and provides excellent protection from sunlight. Avoid contact with strong alkalis, hydrocarbons and fuels. Clean periodically using mild soap solution and a soft cloth.
Two-Hand Control System Note	When the STBVP6 is used with Banner's SC22-3 Safety Controller in a two-hand control system, the power supply to the STBVP6 must be of the same voltage that is used to power the Safety Controller and they must have a common supply ground.
Certifications	

# DUO-TOUCH® Run Bar with STBs

## Two-Hand Control



- Provide a convenient and economical means for safeguarding when interfaced with DUO-TOUCH® Two-Hand Control Modules or comparable control systems
- Minimizes risk of defeat and accidental machine actuation
- Offers ergonomic design for reduced hand, wrist and arm stress
- Constructed of robust, 13-gauge cold-rolled steel
- Provides knockouts for wiring flexibility and installation of accessories such as EZ-LIGHT™ indicators
- Meets ANSI B11.19 and ISO 13851 (EN 574) standards when monitored by Type III C Two-Hand Control logic device (e.g., AT series Two-Hand Control modules, see page 680)

## DUO-TOUCH® Run Bars with STB Self-Checking Touch Buttons

Connection	STB Touch Buttons		Environmental Rating	E-Stop Button	Models*
	Model	Output			
Terminal Strip	STBVP6	Solid-State	IP20	Not included	STBVP6-RB1
8-pin Mini QD**		Complementary PNP		Not included	STBVP6-RB1Q8
Terminal Strip	STBVP6	Solid-State Complementary PNP	IP20	Model SSA-EBM-02L E-stop button (two NC safety contacts)	STBVP6-RB1E02
Terminal Strip	STBVP6	Solid-State	IP65	Not included	STBVP6-RB2
8-pin Mini QD**		Complementary PNP		Not included	STBVP6-RB2Q8
Terminal Strip	STBVP6	Solid-State Complementary PNP	IP65	Model SSA-EBM-02L E-stop button (two NC safety contacts)	STBVP6-RB2E02

\* DUO-TOUCH Run Bar kits available with two-hand control module. Contact factory for combinations.

\*\* Order QDS-8..C cordsets separately.





Additional cordset information is available. See page 758



\* When used with STBVP6-RB2 models change ..-RB1-.. to ..-RB2-..

Additional bracket information is available. See page 753

Telescoping Stands

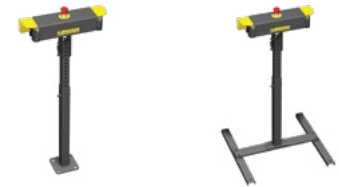

\* When used with STBVP6-RB2 models change ..-RB1-.. to ..-RB2-..  
 NOTE: DUO-TOUCH SG Run Bars are sold separately.

Run Bar Indicators



DUO-TOUCH® Run Bars with STB Self-Checking Touch Buttons

Supply Voltage and Current	10 to 30 V dc @ 75 mA (each button) Power consumption: approx. 1.8W @ 24 V dc (with no output load), for each STB
Supply Protection Circuitry	Protected against transient voltages and reverse polarity
Output Configuration	Complementary PNP (sourcing) open-collector transistors
Output Rating	<b>Maximum load:</b> 150 mA <b>ON-state saturation voltage:</b> +V(supply)-1.5V <b>OFF-state leakage current:</b> < 1 µA
Output Protection Circuitry	Protected against false pulse on power-up; overload and short-circuit protection.
Output Response Time	20 milliseconds ON/OFF
STB Indicators	<b>2 green LEDs:</b> <b>Power:</b> ON—power applied <b>Output/fault:</b> ON—button is activated OFF—button is deactivated Flashing internal fault or blocked button on power-up detected
Construction	<b>STB Buttons:</b> Totally encapsulated, non-metallic enclosure; black polyetherimide yoke housing; fiber-reinforced polyester base; electronics fully epoxy-encapsulated. <b>E-Stop Button:</b> Polyamide red button with metal base. <b>Run Bar Housing:</b> 13 ga. cold rolled steel with powder coat paint; polypropylene copolymer STB mount.
Environmental Rating	STBVP6-RB1 Run Bar models meet IP20 STBVP6-RB2 Run Bar models meet IP65
Connections	<b>Models STBVP6-RB1/RB2 and -RB1E02/RB2E02:</b> Terminal strip connections inside run bar housing (STBs are pre-wired). E-stop button and EZ-LIGHT indicator (if used) are wired separately. <b>Models STBVP6-RB1Q8/RB2Q8:</b> 8-pin Mini-style quick-disconnect fitting. Accessory QD mating cordsets required for QD models. QD cordsets are ordered separately.
Ambient Light Immunity	Up to 100,000 lux
EMI/RFI Immunity	Immune to EMI and RFI noise sources, per IEC 60947-5-2
Operating Conditions	<b>Temperature:</b> 0° to +50 °C <b>Relative humidity:</b> 90% @ +50 °C (non-condensing)
Certification	STB Buttons:  LISTED



## Laser Scanners

Safety laser scanners provide a safety solution for mobile vehicles and stationary applications, such as the interior of robotic work cells, that cannot be solved by other safeguarding solutions.

# AG4 Series

## Safety Laser Scanner



- Two-dimensional laser scanners effectively protect personnel, as well as stationary and mobile systems within a user designated area.
- Eight protective warning field pairs are individually defined using a PC
- Scanner has 0.36° lateral resolution and detects objects in 190° working zone
- The highly flexible protective and warning fields can be set to match the shape of the work area
- Exceeds OSHA/ANSI Control Reliability requirements, certified to cTUVus, and CE certified to Type 3, Cat 3 PLd, and SIL 2
- Compact design with a rugged, die-cast aluminum housing for simple installation into work areas
- Cordsets and brackets see page 695

### AG4 Safety Laser Scanners

Protective Fields	Range		Safety Output	Aux. Outputs	Scanning Angle	Response Time	Model*
	Warning Fields						
30 mm Resolution = 1.6 m 40 mm Resolution = 2.2 m 50 mm Resolution = 2.8 m 70 mm Resolution = 4.0 m 150 mm Resolution = 4.0 m	150 mm Resolution = 15 m		2 PNP OSSD	2 PNP	190°	80 ms (Default) adjustable to 640 ms	AG4-4E
30 mm Resolution = 1.6 m 40 mm Resolution = 2.2 m 50 mm Resolution = 2.8 m 70 mm Resolution = 6.25 m 150 mm Resolution = 6.25 m	150 mm Resolution = 15 m		2 PNP OSSD	2 PNP	190°	80 ms (Default) adjustable to 640 ms	AG4-6E

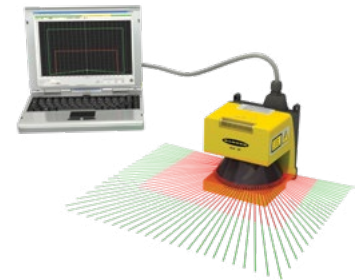

### Configuration and Diagnostic Software

Graphically adjust all device parameters and the protective field contours to both local conditions and required safety distances.

\* Model includes scanner, plugs and CD with diagnostic and configuration software. Cordset ordered separately.

# Test Box



With the test box it's possible to test the following Scanner functions without hooking it up to the machine interface:

- Can be used as a “cloning” device to load the same configuration into multiple scanners
- Switch over between the different field pairs
- Indication of the Safety OSSD outputs (when entering protective field)
- Indication of the Alarm outputs (when entering warning field)
- Machine Interface-to-Test Box cordset included
- Power supply not included

## Test Box for AG4 Safety Laser Scanners

Description	Model
AG4 Test Box	AG4-TB1

## AG4 Safety Laser Scanner Kits

You can purchase a kit that contains a laser scanner, optional interfacing solutions and cordsets.



- Scanner page 693
- Interfacing Options page 697
- Cordsets page 695

### To Order:

1. Choose an optional interfacing solution, such as an **UM-FA-9A** or **-11A** universal input safety module.
2. Choose a DB15 machine interface cordset, such as **AG4-CPD15...**
3. Choose a PC communication cordset, such as **AG4-PCD9...**

See [www.bannerengineering.com](http://www.bannerengineering.com) for complete documentation and a current listing of accessories.

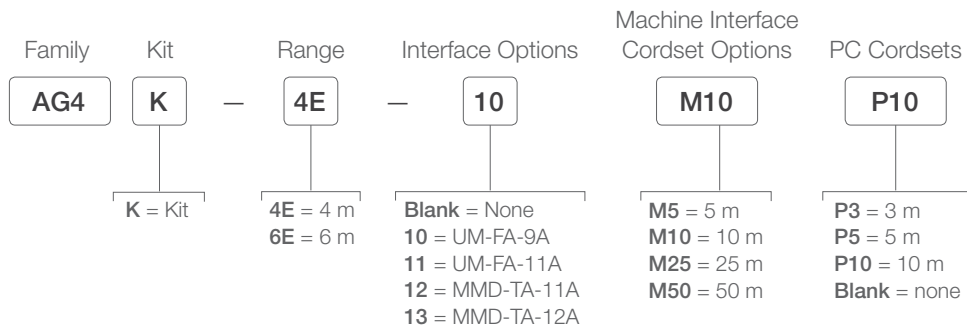





DB15 Machine Interface

- AG4-CPD15-5  
5 m
- AG4-CPD15-10  
10 m
- AG4-CPD15-25  
25 m
- AG4-CPD15-50  
50 m



DB9 PC Communication  
RS-232 Serial Protocol

- AG4-PCD9-3  
3 m
- AG4-PCD9-5  
5 m
- AG4-PCD9-10  
10 m

DB9 to USB†

- AG4-PCD9USB-1  
1 m

† Not recommended for use with AG4-PCD9-10

Additional cordset information is available.  
See page 758

### Misc. Replacement Parts



AG4-MBK1

Additional bracket information is available.  
See page 729

Description	Model
Replacement window	AG4-WIN1
Replacement configuration plug, straight	AG4-CP
Replacement PC plug, straight	AG4-PCD9
Cleaning set (150 ml fluid)	AG4-CLN1
Cleaning set (1000 ml fluid)	AG4-CLN2



### Interface







Additional accessory information is available.  
See page 697



## AG4 Laser Scanner Specifications

Supply Voltage (UB)	24 V dc (+20% / -30%) Power supply in acc. with IEC 742 with safe supply isolation and compensation with voltage dips of up to 20 milliseconds in acc. with EN 61496-1. <b>Over current protection:</b> Via 1.6 A fuse, melting fuse in the cabinet <b>Over-voltage protection:</b> Over-voltage protection with safe limit stop <b>Protective earth conductor:</b> Connection not permitted														
Supply Current	420 mA approx. (use 2.5 A power supply)														
Fuse (power supply)	1.6A normal blow, medium time lag fuse (user supplied)														
Response Time	Min. 80 milliseconds (2 scans)      Max. 640 milliseconds (16 scans)														
Wavelength	905 nm														
Protection Field (Sensing Range)	<table border="0"> <tr> <td><b>AG4-4E:</b></td> <td><b>AG4-6E:</b></td> </tr> <tr> <td><b>150 mm resolution:</b> 200 mm to 4.0 m (radius)</td> <td><b>150 mm resolution:</b> 200 mm to 6.25 m (radius)</td> </tr> <tr> <td><b>70 mm resolution:</b> 200 mm to 4.0 m (radius)</td> <td><b>70 mm resolution:</b> 200 mm to 6.25 m (radius)</td> </tr> <tr> <td><b>50 mm resolution:</b> 200 mm to 2.8 m (radius)</td> <td><b>50 mm resolution:</b> 200 mm to 2.8 m (radius)</td> </tr> <tr> <td><b>40 mm resolution:</b> 200 mm to 2.2 m (radius)</td> <td><b>40 mm resolution:</b> 200 mm to 2.2 m (radius)</td> </tr> <tr> <td><b>30 mm resolution:</b> 200 mm to 1.6 m (radius)</td> <td><b>30 mm resolution:</b> 200 mm to 1.6 m (radius)</td> </tr> <tr> <td colspan="2">Sensing object reflectance: Minimum 1.8%</td> </tr> </table>	<b>AG4-4E:</b>	<b>AG4-6E:</b>	<b>150 mm resolution:</b> 200 mm to 4.0 m (radius)	<b>150 mm resolution:</b> 200 mm to 6.25 m (radius)	<b>70 mm resolution:</b> 200 mm to 4.0 m (radius)	<b>70 mm resolution:</b> 200 mm to 6.25 m (radius)	<b>50 mm resolution:</b> 200 mm to 2.8 m (radius)	<b>50 mm resolution:</b> 200 mm to 2.8 m (radius)	<b>40 mm resolution:</b> 200 mm to 2.2 m (radius)	<b>40 mm resolution:</b> 200 mm to 2.2 m (radius)	<b>30 mm resolution:</b> 200 mm to 1.6 m (radius)	<b>30 mm resolution:</b> 200 mm to 1.6 m (radius)	Sensing object reflectance: Minimum 1.8%	
<b>AG4-4E:</b>	<b>AG4-6E:</b>														
<b>150 mm resolution:</b> 200 mm to 4.0 m (radius)	<b>150 mm resolution:</b> 200 mm to 6.25 m (radius)														
<b>70 mm resolution:</b> 200 mm to 4.0 m (radius)	<b>70 mm resolution:</b> 200 mm to 6.25 m (radius)														
<b>50 mm resolution:</b> 200 mm to 2.8 m (radius)	<b>50 mm resolution:</b> 200 mm to 2.8 m (radius)														
<b>40 mm resolution:</b> 200 mm to 2.2 m (radius)	<b>40 mm resolution:</b> 200 mm to 2.2 m (radius)														
<b>30 mm resolution:</b> 200 mm to 1.6 m (radius)	<b>30 mm resolution:</b> 200 mm to 1.6 m (radius)														
Sensing object reflectance: Minimum 1.8%															
Warning Field	<b>Resolution:</b> 150 mm (at 15 m) <b>Sensing range (radius):</b> 200 mm to 15 m <b>Sensing object reflectance:</b> Minimum 20%														
Monitored Area	0-50 m														
Scanning Angle	max. 190°														
Output Signal Switching Devices (OSSD1, OSSD2)	PNP open-collector transistor 2 outputs: short circuit proofed <b>Rated operating voltage:</b> supply voltage (UB) -3.2 V <b>Max. source current:</b> 250 mA <b>Residual voltage:</b> 3.2 V or less <b>Operation mode:</b> <b>No object in protection field:</b> ON Object inside protection field: OFF <b>Response Time:</b> Min. 80 milliseconds (2 scans) to max. 640 milliseconds (16 scans) switching method														
Alarm (Auxiliary) Outputs 1 & 2	PNP open-collector transistor <b>Rated operating voltage:</b> supply voltage (UB) -4 V <b>Max. source current:</b> 100 mA <b>Residual voltage:</b> 4 V or less <b>Operation mode:</b> Switching method of operation mode (set below) <b>Scanner at normal operation:</b> ON <b>Abnormal operation:</b> OFF <b>No object inside Warning Field:</b> ON Object inside Warning Field: OFF <b>Response Time:</b> Min. 80 milliseconds (2 scans) to max. 640 milliseconds (16 scans) switching method														
Start-Restart	+24 V opto-uncoupled, dynamically monitored														
Field Pair Switchover	Selection of 4 or 8 field pairs via 4 control lines, +24 V opto-uncoupled, dynamically monitored, logically 1 = field pair activated														
Input Signal Definition	<b>High/logical 1:</b> 16-30 V <b>Low/logical 0:</b> less than 3 V														
Laser Protection Class	Class 1 (IEC 60825-1)														
Number of Field Pair Configurations	8 Field Pairs in combination of Protective Field and Warning Field can be switched over by external input. Field Pair number 8 is not user configurable.														
Environmental Rating	IP65 (per IEC 60529)														
Housing Material	Die-cast aluminum with a thermoplastic resin window														
Weight	2.1 kg														
Operating Conditions	<b>Temperature:</b> 0° to 50 °C <b>Humidity:</b> Max. 95%														
Indicators	Five LEDs on front show Safety Sensor Status														
Shock and Vibration	10 to 150 Hz frequency, 5 G max. (50 m/s <sup>2</sup> approx.) in X, Y and Z directions for twenty times each														
Max. Cordset Length	<b>15-pin plug:</b> 50 m <b>9-pin plug:</b> 10 m (RS-232C), 50 m (RS-422)														
Design Standards	IEC 61496-1/-3 (Type 3), ISO 13849-1 (Category 3, PLd), IEC 61508-1 to -7 (SIL2) and IEC 62061 SIL CL2														
Certifications	  <p>TUV Rheinland of North America, a Nationally Recognized Test Laboratory (NRTL) in the United States according to OSHA 29 CFR 1910.7, and accredited by the Standards Council of Canada to test and certify products to Canadian National Standards, has certified the AG4 Laser Scanner to all applicable U.S. and Canadian National Standards. The cTUVus mark is recognized throughout the United States and Canada by OSHA and the SCC.</p>														

AG4 Interfacing Products

	Description	Models	Product Information
Interface Modules and Controllers	 <ul style="list-style-type: none"> <li>• Universal input safety modules monitors both contact-based and PNP solid-state input devices</li> <li>• Convenient plug-in terminal blocks on a 22.5 mm DIN-rail mountable housing</li> </ul>	<p>UM-FA-9A (3 NO)</p> <p>UM-FA-11A (2 NO/1NC)</p>	Page 698
	 <ul style="list-style-type: none"> <li>• Control system monitors a variety of input devices such as e-stop buttons, rope pulls, enabling devices, protective safety stops, interlocked guards or gates, optical sensors, two-hand controls and safety mats</li> <li>• Intuitive programming environment for easy implementation</li> <li>• Configure inputs, outputs and functionality of the controller for more usability</li> <li>• Base controller allows eight of the 26 inputs to be configured as outputs for efficient terminal utilization</li> <li>• Ethernet models available providing up to 64 virtual status outputs, fault diagnostic codes and messages</li> </ul>	<p>SC26-2</p> <p>SC26-2D</p> <p>SC26-2E</p> <p>SC26-2DE</p>	Page 588
	 <ul style="list-style-type: none"> <li>• One controller provides configurable monitoring of multiple safety devices</li> <li>• 22 input terminals can monitor both contact-based and PNP solid-state input devices</li> <li>• 3 pairs of independent solid-state safety outputs can be used with selectable one- or two-channel external device monitoring</li> <li>• Ten configurable non-safety status outputs track inputs, outputs, lockout, I/O status and other functions</li> <li>• All SC22-3 modules use 24 V dc</li> <li>• 10/100 Base TX Ethernet communication option using EtherNet/IP and Modbus TCP protocols (SC22-3E models)</li> </ul>	<p>SC22-3-S...</p> <p>SC22-3-C...</p> <p>SC22-3E-S...</p> <p>SC22-3E-C...</p>	Page 584
Muting Modules	 <ul style="list-style-type: none"> <li>• The Muting Module temporarily inhibits a safety light screen so materials can safely pass through the screen without stopping the machinery</li> <li>• The module uses redundant microcontroller-based logic</li> <li>• MMD Modules can be used as dual controllers when muting function is not used</li> </ul>	<p>MMD-TA-12B</p> <p>MMD-TA-11B</p>	Page 710

NC = Normally closed, NO = Normally open



## Safety Modules

Industrial safety controllers and modules provide an interface between safety devices and the machines; monitoring those devices for an easy-to-use safety control solution.

Series	Description	Safety Rating	Safety Outputs	Aux Outputs	Power Supply
	<b>E-Stop &amp; Guard</b> Modules monitor contacts of E-stop switches, guard interlock switches or the outputs of other safety modules. page 699	Category 2 or 4, depending on model	2 NO, 3 NO, 4 NO	1 NC, 1 NC & 2 PNP	24 V ac/dc, 115 V ac & 12-24 V dc, 230 V ac & 12-24 V dc or 24 V dc
	<b>Universal Input</b> Modules monitor one or two solid-state PNP or relay contact outputs from safety or non-safety devices, such as sensors or safety light screens. page 706	Category 2, 3 or 4 PLe	3 NO or 2 NO	1 NC, depending on model	24 V ac/dc
	<b>Safety Mat Monitoring</b> Modules monitor one 4-wire safety mat (or multiple connected in series). page 708	Category 3 (with mat)	4 NO	1 NC & 2 PNP	115 V ac & 12-24 V dc or 230 V ac & 12-24 V dc
	<b>Muting</b> Modules suspend safeguarding during non-hazardous time in the machine's cycle. page 710	Category 2, 3 or 4 PLe	2 PNP OSSD or 2 NO	1 PNP or 1 NC	24 V dc
	<b>Safe Speed</b> Modules monitor two sensors with PNP outputs for rotation and linear movements. page 714	Category 3 PLe	2 NO	1 NC	24 V ac/dc
	<b>Interface Relay</b> Dual input accepts the safety output of a safety device with solid-state or contact outputs and external device monitoring. page 716	Category 2, 3 or 4 (Depends on hookup)	3 NO or 2 NO	1 NC, depending on model	24 V dc
	<b>Extension Relay</b> Contact expansion for safety modules with contact outputs and external device monitoring. page 718	Category 2, 3 or 4 (Depends on hookup)	4 NO or 4 NO (w/delay)	—	24 V dc or 24 V ac/dc, depending on model

# E-Stop & Interlocked Guard

## Safety Modules



- Modules monitor positive-opening E-Stop and interlocking switches for proper operation, contact failure or wiring faults
- AC and DC models available
- Module goes into lockout mode if fault is detected
- Housing are rugged polycarbonate and mount to standard 35 mm DIN rail
- Functional Stop Category 0 per NFPA79 and IEC 60204-1
- Relay outputs are capable of reliably switching low or high current applications (depending on model)

## E-Stop & Guard Safety Modules

Supply Voltage	Inputs	Safety Outputs	Aux. Outputs	Output Rating	Output Response Time	Model
24 V ac/dc	1 NC & 1 NO (single or dual)	2 NO	—	6 amps	35 ms	GM-FA-10J
24 V ac/dc	1 NC (single) or 2 NC (dual)	3 NO	—	6 amps	25 ms	ES-FA-9AA
24 V ac/dc	1 NC (single) or 2 NC (dual)	2 NO	1 NC	7 amps	25 ms	ES-FA-11AA
24 V ac/dc	1 NC (single)	3 NO	1 NC	6 amps	35 ms	ES-FA-6G
115 V ac & 12-24 V dc	1 NC (single) or 2 NC (dual)	4 NO	1 NC & 2 PNP	6 amps	25 ms	ES-UA-5A
230 V ac & 12-24 V dc	1 NC (single) or 2 NC (dual)	4 NO	1 NC & 2 PNP	6 amps	25 ms	ES-VA-5A

NC = Normally Closed Relay, NO = Normally Open Relay

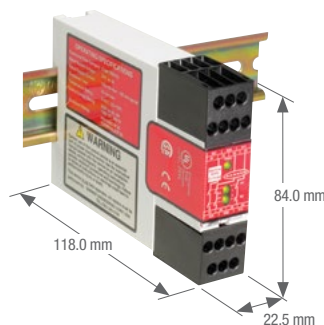

ES-FA-9AA & GM-FA-10J Models

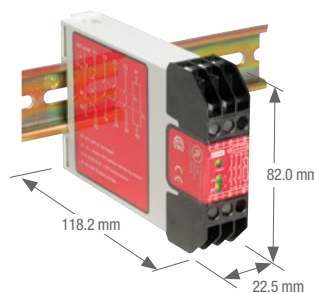



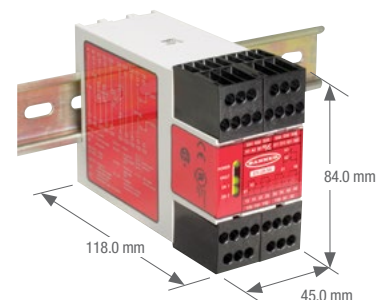





ES-FA-6G Models



ES-UA-5A Models

## GM-FA-10J Guard Monitoring Module Specifications

Supply Voltage and Current	24 V dc $\pm 15\%$ @ 150 mA (SELV-rated supply according to EN IEC 60950, NEC Class 2) 24 V ac $\pm 15\%$ @ 150 mA, 50-60 Hz $\pm 5\%$ (NEC Class 2-rated transformer) <b>Power consumption:</b> approx. 3 VA / 3 W To comply with UL and CSA standards, the isolated secondary power supply circuit in the installation must incorporate a method to limit the overvoltage to 0.8 kV												
Supply Protection Circuitry	Protected against transient voltages and reverse polarity												
Overvoltage Category	<b>Output relay contact voltage of 1 V to 150 V ac/dc:</b> Category III <b>Output relay contact voltage of 151 V to 250 V ac/dc:</b> Category II (Category III, if appropriate overvoltage reduction is provided, as described in data sheet.)												
Pollution Degree	2												
Output Configuration	<p>Each normally open output channel is a series connection of contacts from two forced-guided (mechanically linked) relays, K1-K2</p> <p><b>Contacts:</b> AgNi, 5 <math>\mu</math>m gold-plated</p> <p><b>Low Current Rating:</b> The 5 <math>\mu</math>m gold-plated contacts allow the switching of low current/low voltage. In these low-power applications, multiple contacts can also be switched in series (e.g., "dry switching")</p> <p>To preserve the gold plating on the contacts, do not exceed the following max. values at any time:</p> <table> <tr> <td><b>Min. voltage:</b> 1 V ac/dc</td> <td><b>Max. voltage:</b> 60 V</td> </tr> <tr> <td><b>Min. current:</b> 5 mA ac/dc</td> <td><b>Max. current:</b> 300 mA</td> </tr> <tr> <td><b>Min power:</b> 5 mW (5 mVA)</td> <td><b>Max. power:</b> 7 W (7 VA)</td> </tr> </table> <p><b>High Current Rating:</b> If higher loads must be switched through one or more of the contacts, the minimum and maximum values of the contact(s) changes to:</p> <table> <tr> <td> <b>EMERGENCY STOP DEVICE 29YL</b></td> <td><b>Minimum:</b> <b>Voltage:</b> 15 V ac/dc <b>Current:</b> 30 mA ac/dc <b>Power:</b> 0.45 W (0.45 VA)</td> <td><b>Maximum:</b> 250 V ac/24 V dc, 6A resistive B300, R300 per UL508</td> </tr> <tr> <td></td> <td><b>Minimum:</b> <b>Voltage:</b> 15 V ac/dc <b>Current:</b> 30 mA ac/dc <b>Power:</b> 0.45 W (0.45 VA)</td> <td><b>Maximum:</b> 250 V ac/24 V dc, 6A resistive <b>IEC 60947-5-1:</b> <b>AC15:</b> 230 V ac, 3 A; <b>DC-13:</b> 24 V dc, 2A</td> </tr> </table> <p><b>Mechanical life:</b> <math>\geq 50,000,000</math> operations <b>Electrical life (switching cycles of the output contacts, resistive load):</b> 150,000 cycles @ 900 VA; 1,000,000 cycles @ 250 VA; 2,000,000 cycles @ 150 VA; 5,000,000 cycles @ 100 VA</p> <p>NOTE: Transient suppression is recommended when switching inductive loads. Install suppressors across load. Never install suppressors across output contacts.</p>	<b>Min. voltage:</b> 1 V ac/dc	<b>Max. voltage:</b> 60 V	<b>Min. current:</b> 5 mA ac/dc	<b>Max. current:</b> 300 mA	<b>Min power:</b> 5 mW (5 mVA)	<b>Max. power:</b> 7 W (7 VA)	 <b>EMERGENCY STOP DEVICE 29YL</b>	<b>Minimum:</b> <b>Voltage:</b> 15 V ac/dc <b>Current:</b> 30 mA ac/dc <b>Power:</b> 0.45 W (0.45 VA)	<b>Maximum:</b> 250 V ac/24 V dc, 6A resistive B300, R300 per UL508		<b>Minimum:</b> <b>Voltage:</b> 15 V ac/dc <b>Current:</b> 30 mA ac/dc <b>Power:</b> 0.45 W (0.45 VA)	<b>Maximum:</b> 250 V ac/24 V dc, 6A resistive <b>IEC 60947-5-1:</b> <b>AC15:</b> 230 V ac, 3 A; <b>DC-13:</b> 24 V dc, 2A
<b>Min. voltage:</b> 1 V ac/dc	<b>Max. voltage:</b> 60 V												
<b>Min. current:</b> 5 mA ac/dc	<b>Max. current:</b> 300 mA												
<b>Min power:</b> 5 mW (5 mVA)	<b>Max. power:</b> 7 W (7 VA)												
 <b>EMERGENCY STOP DEVICE 29YL</b>	<b>Minimum:</b> <b>Voltage:</b> 15 V ac/dc <b>Current:</b> 30 mA ac/dc <b>Power:</b> 0.45 W (0.45 VA)	<b>Maximum:</b> 250 V ac/24 V dc, 6A resistive B300, R300 per UL508											
	<b>Minimum:</b> <b>Voltage:</b> 15 V ac/dc <b>Current:</b> 30 mA ac/dc <b>Power:</b> 0.45 W (0.45 VA)	<b>Maximum:</b> 250 V ac/24 V dc, 6A resistive <b>IEC 60947-5-1:</b> <b>AC15:</b> 230 V ac, 3 A; <b>DC-13:</b> 24 V dc, 2A											
Output Response Time	35 milliseconds max.												
Input Requirements	Each switch or sensor must have a normally closed contact and a normally open contact capable of switching 20 to 50 mA @ 15 to 30 V dc <b>Reset switch:</b> 20 mA @ 12 V dc, hard contact only Max. external resistance between terminals S11/S12, S11/S13, S21/S22 and S21/S23: 270 ohms each.												
Simultaneity Monitoring	<b>2-Channel operation:</b> 3 seconds <b>1-Channel operation:</b> infinite												
Status Indicators	<b>4 green LEDs:</b> <b>Power:</b> power is supplied to Safety Module <b>Channel 1:</b> inputs satisfied (guard closed) <b>Channel 2:</b> inputs satisfied (guard closed) <b>Output:</b> K1 and K2 energized, safety outputs closed	<b>1 red LED:</b> Fault											
Construction	Polycarbonate housing												
Environmental Rating	IEC IP20												
Mounting	Mounts to standard 35 mm DIN rail track. Safety Module must be installed inside an enclosure rated NEMA 3 (IP54), or better.												
Vibration Resistance	10 to 55 Hz @ 0.35 mm displacement per IEC 60068-2-6												
Operating Conditions	<b>Temperature:</b> 0° to +50 °C <b>Relative humidity:</b> 90% @ +50 °C (non-condensing)												
Design Standards	 : Cat. 4 PL e, per EN ISO 13849-1; SIL 3 per IEC 61508 and IEC 62061												
Certifications	  <b>EMERGENCY STOP DEVICE 29YL</b>												









## ES-FA-..AA Safety Module Specifications

Supply Voltage and Current	24 V dc $\pm$ 10% (SELV-rated supply according to EN IEC 60950, NEC Class 2) 24 V ac $\pm$ 10%, 50/60Hz (NEC Class 2-rated transformer) <b>Power consumption:</b> approx. 2 W/2 VA																
Supply Protection Circuitry	Protected against transient voltages and reverse polarity																
Overvoltage Category	<b>Output relay contact voltage of 1 V to 150 V ac/dc:</b> Category III <b>Output relay contact voltage of 151 V to 250 V ac/dc:</b> Category III, if appropriate overvoltage reduction is provided, as described in data sheet																
Pollution Degree	2																
Output Configuration	<p><b>ES-FA-9AA:</b> 3 normally open (NO) output channels <b>ES-FA-11AA:</b> 2 normally open (NO) output channels and 1 normally closed (NC) auxiliary output</p> <p>Each normally open output channel is a series connection of contacts from two forced-guided (mechanically linked) relays, K1-K2. The normally closed Aux. output channel of the ES-FA-11AA is a parallel connection of contacts from two forced-guided relays, K1-K2.</p> <p><b>Contacts:</b> AgNi, 5 <math>\mu</math>m gold-plated</p> <p><b>Low Current Rating:</b> The 5 <math>\mu</math>m gold-plated contacts allow the switching of low current/low voltage. In these low-power applications, multiple contacts can also be switched in series (e.g., "dry switching")</p> <p>To preserve the gold plating on the contacts, do not exceed the following max. values at any time:</p> <table border="0"> <tr> <td><b>Minimum:</b></td> <td><b>Maximum:</b></td> </tr> <tr> <td><b>Voltage:</b> 1 V ac/dc</td> <td><b>Voltage:</b> 60 V</td> </tr> <tr> <td><b>Current:</b> 5 mA ac/dc</td> <td><b>Current:</b> 300 mA</td> </tr> <tr> <td><b>Power:</b> 5 mW (5 mVA)</td> <td><b>Power:</b> 7 W (7 VA)</td> </tr> </table> <p><b>High Current Rating:</b> If higher loads must be switched through one or more of the contacts, the minimum and maximum values of the contact(s) change to:</p> <table border="0"> <tr> <td><b>Minimum:</b></td> <td><b>Maximum:</b></td> </tr> <tr> <td><b>Voltage:</b> 15 V ac/dc</td> <td><b>Voltage:</b> 250 V ac/dc</td> </tr> <tr> <td><b>Current:</b> 30 mA ac/dc</td> <td><b>Current:</b> ES-FA-9AA: 6A    ES-FA-11AA: 7 A</td> </tr> <tr> <td><b>Power:</b> 0.45 W (0.45 VA)</td> <td><b>Power:</b> ES-FA-9AA: 200 W (1,500 VA)    ES-FA-11AA: 200 W (1,750 VA)</td> </tr> </table> <p><b>Mechanical life:</b> &gt; 20,000,000 operations</p> <p><b>Electrical life (switching cycles of the output contacts, resistive load):</b> 150,000 cycles @ 1,500 VA; 1,000,000 cycles @ 450 VA; 2,000,000 cycles @ 250 VA; 5,000,000 cycles @ 125 VA</p> <p>NOTE: Transient suppression is recommended when switching inductive loads. Install suppressors across load. Never install suppressors across output contacts.</p>	<b>Minimum:</b>	<b>Maximum:</b>	<b>Voltage:</b> 1 V ac/dc	<b>Voltage:</b> 60 V	<b>Current:</b> 5 mA ac/dc	<b>Current:</b> 300 mA	<b>Power:</b> 5 mW (5 mVA)	<b>Power:</b> 7 W (7 VA)	<b>Minimum:</b>	<b>Maximum:</b>	<b>Voltage:</b> 15 V ac/dc	<b>Voltage:</b> 250 V ac/dc	<b>Current:</b> 30 mA ac/dc	<b>Current:</b> ES-FA-9AA: 6A    ES-FA-11AA: 7 A	<b>Power:</b> 0.45 W (0.45 VA)	<b>Power:</b> ES-FA-9AA: 200 W (1,500 VA)    ES-FA-11AA: 200 W (1,750 VA)
<b>Minimum:</b>	<b>Maximum:</b>																
<b>Voltage:</b> 1 V ac/dc	<b>Voltage:</b> 60 V																
<b>Current:</b> 5 mA ac/dc	<b>Current:</b> 300 mA																
<b>Power:</b> 5 mW (5 mVA)	<b>Power:</b> 7 W (7 VA)																
<b>Minimum:</b>	<b>Maximum:</b>																
<b>Voltage:</b> 15 V ac/dc	<b>Voltage:</b> 250 V ac/dc																
<b>Current:</b> 30 mA ac/dc	<b>Current:</b> ES-FA-9AA: 6A    ES-FA-11AA: 7 A																
<b>Power:</b> 0.45 W (0.45 VA)	<b>Power:</b> ES-FA-9AA: 200 W (1,500 VA)    ES-FA-11AA: 200 W (1,750 VA)																
Output Response Time	25 milliseconds typical																
Input Requirements	<p><b>Safety input switch:</b> Dual-Channel (contacts) hookup – 10 to 20 mA steady state @ 12 V dc NOTE: Inputs are designed with a brief contact-cleaning current of 100 mA when initially closed.</p> <p>Single-Channel hookup – 40 to 100 mA @ 24 V ac/dc +/- 10%; 50/60 Hz <b>Reset switch:</b> 20 mA @ 12 V dc, hard contact only</p>																
Minimum OFF-State Recovery Time	250 milliseconds																
Status Indicators	<b>3 green LEDs:</b> Power ON    K1 energized    K2 energized																
Construction	Polycarbonate housing																
Environmental Rating	Rated NEMA 1; IP40, Terminals IP20																
Mounting	Mounts to standard 35 mm DIN rail track. Safety Module must be installed inside an enclosure rated NEMA 3 (IP54), or better.																
Vibration Resistance	10 to 55Hz @ 0.35 mm displacement per IEC 60068-2-6																
Operating Conditions	<b>Temperature:</b> 0° to +50 °C <b>Relative humidity:</b> 90% @ +50 °C (non-condensing)																
Design Standards	Cat. 4 PL e per EN ISO 13849-1; SIL 3 per IEC 61508 and IEC 62061																
Certifications	  <b>EMERGENCY STOP DEVICE 29YL</b>																





ES-..A-5A Safety Module Specifications



<p><b>Supply Voltage and Current</b></p>	<p><b>AI-A2:</b> 115 V ac (model ES-UA-5A) or 230 V ac (model ES-VA-5A) ±15%, 50/60Hz  <b>BI-B2:</b> 11 V dc – 27.6 V dc  <b>Power consumption:</b> approx. 4 W/7 VA                      The Safety Module should be connected only to a SELV (safety extra-low voltage, for circuits without earth ground) or a PELV (protected extra-low voltage, for circuits with earth ground) power supply.</p>																																			
<p><b>Supply Protection Circuitry</b></p>	<p>Protected against transient voltages and reverse polarity</p>																																			
<p><b>Overvoltage Category</b></p>	<p>Output relay contact voltage of 1 V to 150 V ac/dc: Category III                      Output relay contact voltage of 151 V to 250 V ac/dc: Category III, if appropriate overvoltage reduction is provided, as described in data sheet</p>																																			
<p><b>Pollution Degree</b></p>	<p>2</p>																																			
<p><b>Output Configuration</b></p>	<p>4 normally open (NO) output channels; 1 normally closed (NC) and 2 solid-state auxiliary outputs</p> <p>Each normally open output channel is a series connection of contacts from two forced-guided (mechanically linked) relays, K1-K2. The normally closed Aux. output channel is a parallel connection of contacts from two forced-guided relays, K1-K2.</p> <p><b>Contacts:</b> AgNi, 5 µm gold-plated  <b>Low Current Rating:</b> The 5 µm gold-plated contacts allow the switching of low current/low voltage. In these low-power applications, multiple contacts can also be switched in series (e.g., “dry switching”) To preserve the gold plating on the contacts, do not exceed the following max. values at any time:</p> <table border="0"> <tr> <td><b>Minimum:</b></td> <td><b>Maximum:</b></td> </tr> <tr> <td><b>Voltage:</b> 1 V ac/dc</td> <td><b>Voltage:</b> 60 V</td> </tr> <tr> <td><b>Current:</b> 5 mA ac/dc</td> <td><b>Current:</b> 300 mA</td> </tr> <tr> <td><b>Power:</b> 5 mW (5 mVA)</td> <td><b>Power:</b> 7 W (7 VA)</td> </tr> </table> <p><b>High Current Rating:</b> If higher loads must be switched through one or more of the contacts, the minimum and maximum values of the contact(s) changes to:</p> <table border="0"> <tr> <td></td> <td><b>Minimum:</b></td> <td><b>Maximum:</b></td> </tr> <tr> <td></td> <td><b>Voltage:</b> 15 V ac/dc</td> <td>NO Safety Contacts (13-14, 23-24, 33-34, 43-44): 250 V ac/ 24 V dc, 6A resistive B300, Q300 (UL508)</td> </tr> <tr> <td></td> <td><b>Current:</b> 250 mA ac/dc</td> <td>NC Auxiliary Contact (51-52): 250 V ac/ 24 V dc, 5A resistive B300, Q300 (UL508)</td> </tr> <tr> <td></td> <td><b>Power:</b> 5 W (5 VA)</td> <td></td> </tr> </table> <table border="0"> <tr> <td></td> <td><b>Minimum:</b></td> <td><b>Maximum— IEC60947-5-1</b></td> </tr> <tr> <td></td> <td><b>Voltage:</b> 15 V ac/dc</td> <td><b>NO Safety Contact:</b> AC-1: 250 V ac, 6A; DC-1: 24 V dc, 6A</td> </tr> <tr> <td></td> <td><b>Current:</b> 250 mA ac/dc</td> <td>AC-15: 230 V ac, 3A; DC-13: 24 V dc, 4A</td> </tr> <tr> <td></td> <td><b>Power:</b> 5 W (5 VA)</td> <td><b>NC Auxiliary Contact:</b> AC-1: 250 V ac, 5A; DC-1: 24 V dc, 5A</td> </tr> <tr> <td></td> <td></td> <td>AC-15: 230 V ac, 2A; DC-13: 24 V dc, 4A</td> </tr> </table> <p></p> <p><b>Mechanical life:</b> &gt; 20,000,000 operations</p> <p><b>Electrical life (switching cycles of the output contacts, resistive load):</b> 150,000 cycles @ 1,500 VA; 1,000,000 cycles @ 450 VA; 2,000,000 cycles @ 250 VA; 5,000,000 cycles @ 125 VA</p> <p>NOTE: Transient suppression is recommended when switching inductive loads. Install suppressors across load. Never install suppressors across output contacts.</p> <p><b>Solid-State Monitor Outputs:</b></p> <ul style="list-style-type: none"> <li>- Two non-safety solid-state dc outputs</li> <li>- Output at Y32 monitors state of outputs – conducts (output high) when both K1 and K2 are energized</li> <li>- Output at Y35 conducts (output high) when in normal operation (no lockout)</li> <li>- Output circuits require application of +12-24 V dc ±15% at terminal Y31; dc common at Y30</li> <li>- Maximum switching current: 100 mA at 12-24 V dc</li> <li>- Both outputs are protected against short circuits</li> </ul>	<b>Minimum:</b>	<b>Maximum:</b>	<b>Voltage:</b> 1 V ac/dc	<b>Voltage:</b> 60 V	<b>Current:</b> 5 mA ac/dc	<b>Current:</b> 300 mA	<b>Power:</b> 5 mW (5 mVA)	<b>Power:</b> 7 W (7 VA)		<b>Minimum:</b>	<b>Maximum:</b>		<b>Voltage:</b> 15 V ac/dc	NO Safety Contacts (13-14, 23-24, 33-34, 43-44): 250 V ac/ 24 V dc, 6A resistive B300, Q300 (UL508)		<b>Current:</b> 250 mA ac/dc	NC Auxiliary Contact (51-52): 250 V ac/ 24 V dc, 5A resistive B300, Q300 (UL508)		<b>Power:</b> 5 W (5 VA)			<b>Minimum:</b>	<b>Maximum— IEC60947-5-1</b>		<b>Voltage:</b> 15 V ac/dc	<b>NO Safety Contact:</b> AC-1: 250 V ac, 6A; DC-1: 24 V dc, 6A		<b>Current:</b> 250 mA ac/dc	AC-15: 230 V ac, 3A; DC-13: 24 V dc, 4A		<b>Power:</b> 5 W (5 VA)	<b>NC Auxiliary Contact:</b> AC-1: 250 V ac, 5A; DC-1: 24 V dc, 5A			AC-15: 230 V ac, 2A; DC-13: 24 V dc, 4A
<b>Minimum:</b>	<b>Maximum:</b>																																			
<b>Voltage:</b> 1 V ac/dc	<b>Voltage:</b> 60 V																																			
<b>Current:</b> 5 mA ac/dc	<b>Current:</b> 300 mA																																			
<b>Power:</b> 5 mW (5 mVA)	<b>Power:</b> 7 W (7 VA)																																			
	<b>Minimum:</b>	<b>Maximum:</b>																																		
	<b>Voltage:</b> 15 V ac/dc	NO Safety Contacts (13-14, 23-24, 33-34, 43-44): 250 V ac/ 24 V dc, 6A resistive B300, Q300 (UL508)																																		
	<b>Current:</b> 250 mA ac/dc	NC Auxiliary Contact (51-52): 250 V ac/ 24 V dc, 5A resistive B300, Q300 (UL508)																																		
	<b>Power:</b> 5 W (5 VA)																																			
	<b>Minimum:</b>	<b>Maximum— IEC60947-5-1</b>																																		
	<b>Voltage:</b> 15 V ac/dc	<b>NO Safety Contact:</b> AC-1: 250 V ac, 6A; DC-1: 24 V dc, 6A																																		
	<b>Current:</b> 250 mA ac/dc	AC-15: 230 V ac, 3A; DC-13: 24 V dc, 4A																																		
	<b>Power:</b> 5 W (5 VA)	<b>NC Auxiliary Contact:</b> AC-1: 250 V ac, 5A; DC-1: 24 V dc, 5A																																		
		AC-15: 230 V ac, 2A; DC-13: 24 V dc, 4A																																		
<p><b>Output Response Time</b></p>	<p>35 milliseconds max. (25 milliseconds typical)</p>																																			
<p><b>Input Requirements</b></p>	<p>E-stop switch must have normally closed contacts each capable of switching 20 to 50 mA @ 12 to 30 V dc; and must be open ≥15 milliseconds for a valid stop command                      Maximum input resistance 250 ohms per channel @ 24 V dc supply voltage                      Maximum input resistance 25 ohms per channel @ 12 V dc supply voltage                      Reset switch must have one normally open contact capable of switching 20 to 50 mA @ 12 to 30 V ac/dc</p>																																			
<p><b>OFF-State Recovery Time</b></p>	<p>350 milliseconds</p>																																			
<p><b>Status Indicators</b></p>	<table border="0"> <tr> <td><b>3 green LEDs:</b></td> <td><b>1 red LED:</b></td> </tr> <tr> <td>Power ON</td> <td>Fault Condition</td> </tr> <tr> <td>Channel 1</td> <td></td> </tr> <tr> <td>Channel 2</td> <td></td> </tr> </table>	<b>3 green LEDs:</b>	<b>1 red LED:</b>	Power ON	Fault Condition	Channel 1		Channel 2																												
<b>3 green LEDs:</b>	<b>1 red LED:</b>																																			
Power ON	Fault Condition																																			
Channel 1																																				
Channel 2																																				

Continued on next page 

## ES-...A-5A Safety Module Specifications (cont'd)

Construction	Polycarbonate housing
Environmental Rating	Rated NEMA 1; IEC IP20
Mounting	Mounts to standard 35 mm DIN rail track. Safety Module must be installed inside an enclosure rated NEMA 3 (IP54), or better.
Vibration Resistance	10 to 60Hz @ 0.35 mm displacement per UL 991 60 to 150 Hz @ 5 g max.
Operating Conditions	<b>Temperature:</b> 0° to +50 °C (surrounding air) <b>Relative humidity:</b> 90% @ +50 °C (non-condensing)
Design Standards	Cat. 4 PL e per EN ISO 13849-1; SIL 3 per IEC 61508 and IEC 62061
Certifications	  

ES-FA-6G Safety Module Specifications

Supply Voltage and Current	24 V ac/dc, +/- 10%; 50/60Hz <b>Power consumption:</b> approx. 2 W/0.75 VA
Supply Protection Circuitry	Protected against transient voltages and reverse polarity
Output Configuration	Outputs (K1 & K2): three redundant (total of six) safety relay (forced-guided) contacts – AgSnO2 one auxiliary non-safety monitor output (open when both K1 and K2 are energized; closed when either K1 or K2 are de-energized) <b>Contact ratings:</b> <b>Max. voltage:</b> 250 V ac or 250 V dc <b>Max. current:</b> 6 A ac or dc <b>Min. current:</b> 30 mA @ 10 V dc <b>Max. power:</b> 1500 VA, 150 W <b>Mechanical life:</b> 10,000,000 operations Electrical life: 100,000 at full resistive load  NOTE: Transient suppression is recommended when switching inductive loads. Install suppressors across load. Never install suppressors across output contacts.
Output Response Time	35 milliseconds typical
Input Requirements	Input switch must have a normally closed contact capable of switching 40 to 100 mA @ 13 to 27 V ac/dc Reset switch must have one normally open contact capable of switching 20 to 30 mA @ 13 to 27 V ac/dc
Status Indicators	<b>3 green LEDs:</b> Power ON K1 energized K2 energized
Construction	Polycarbonate
Environmental Rating	Rated NEMA 1; IP40, Terminals IP20
Mounting	Mounts to standard 35 mm DIN rail track. Safety Module must be installed inside an enclosure rated NEMA 3 (IP54), or better.
Vibration Resistance	10 to 55 Hz @ 0.35 mm displacement per IEC 60068-2-6
Operating Conditions	<b>Temperature:</b> 0° to +50 °C <b>Relative humidity:</b> 90% @ +50 °C (non-condensing)
Certifications	<div style="display: flex; align-items: center;"> <div style="margin-right: 20px;">  <p>EMERGENCY STOP DEVICE 29YL</p> </div> <div style="margin-right: 20px;">  </div> <div> <p><b>Important Notice:</b>                      European Community Machinery Directive 2006/42/EC                      The ES-FA-6G Safety Module complies with Machinery Directive 98/37/EC, but not with Machinery Directive 2006/42/EC. Therefore, this Safety Module can only be installed as replacement component within the European Union (EU). For more information, please see <a href="http://www.bannerengineering.com/144763">www.bannerengineering.com/144763</a> or call 1-888-373-6767.</p> </div> </div>

# Universal Input

## Safety Modules



- Modules monitor one or two solid-state PNP outputs or relay contact outputs from safety or non-safety devices such as sensors, safety light screens or one or two electromechanical contacts
- Modules are an ideal choice for monitoring safety devices without external device monitoring (EDM) function
- Modules have single or dual channel inputs to monitor outputs from safety or non-safety devices
- Can be configured to monitor devices with solid-state PNP outputs or hard/relay contact outputs using DIP switches under removable terminals
- Housings are rugged polycarbonate and mount to standard 35 mm DIN rail
- Relay outputs are capable of reliably switching low or high current applications

### Universal Safety Input Modules

Supply Voltage	Inputs	Safety Outputs	Aux. Output	Output Rating	Output Response Time	Model
24 V ac/dc	1 NC (single) or 2 NC (dual)	3 NO	–	6 amps	25 ms	UM-FA-9A
24 V ac/dc	1 NC (single) or 2 NC (dual)	2 NO	1 NC	7 amps	25 ms	UM-FA-11A

NC = Normally Closed Relay, NO = Normally Open Relay

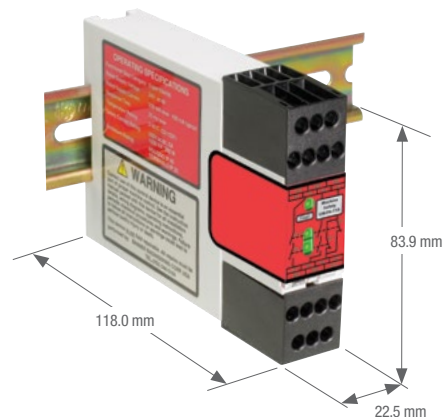

UM-FA-..A Models

Universal Safety Input Module Specifications

Supply Voltage and Current	24 V dc ±10% (SELV-rated supply according to EN IEC 60950, NEC Class 2) 24 V ac ±10% 50-60 Hz (NEC Class 2-rated transformer) <b>Power consumption:</b> approx. 2 VA / 3 W																		
Supply Protection Circuitry	Protected against transient voltages and reverse polarity																		
Overvoltage Category	<b>Output relay contact voltage of 1 V to 150 V ac/dc:</b> Category III <b>Output relay contact voltage of 151 V to 250 V ac/dc:</b> Category II (Category III if appropriate overvoltage reduction is provided, as described in data sheet.)																		
Pollution Degree	2																		
Output Configuration	<b>UM-FA-9A:</b> 3 normally open (NO) output channels <b>UM-FA-11A:</b> 2 normally open (NO) output channels and 1 normally closed (NC) auxiliary output channel  Each normally open output channel is a series connection of contacts from two forced-guided (mechanically linked) relays, K1-K2. The normally closed Aux. output channel of the UM-FA-11A is a parallel connection of contacts from two forced-guided relays, K1-K2.  <b>Contacts:</b> AgNi, 5 µm gold-plated  <b>Low Current Rating:</b> The 5 µm gold-plated contacts allow the switching of low current/low voltage. In these low-power applications, multiple contacts can also be switched in series (e.g., “dry switching”). <b>To preserve the gold plating on the contacts, do not exceed the following max. values at any time:</b>  <table border="0"> <tr> <td><b>Min. voltage:</b> 1 V ac/dc</td> <td><b>Max. voltage:</b> 60 V</td> <td></td> </tr> <tr> <td><b>Min. current:</b> 5 mA ac/dc</td> <td><b>Max. current:</b> 300 mA</td> <td></td> </tr> <tr> <td><b>Min. power:</b> 5 mW (5 mVA)</td> <td><b>Max. power:</b> 7 W (7 VA)</td> <td></td> </tr> </table> <b>High Current Rating:</b> If higher loads must be switched through one or more of the contacts, the minimum and maximum values of the contact(s) changes to: <table border="0"> <tr> <td><b>Min. voltage:</b> 15 V ac/dc</td> <td><b>Max. voltage:</b> 250 V ac/dc</td> <td></td> </tr> <tr> <td><b>Min. current:</b> 30 mA ac/dc</td> <td><b>Max. current:</b> UM-FA-9A: 6 A</td> <td><b>UM-FA-11A:</b> 7 A</td> </tr> <tr> <td><b>Min. power:</b> 0.45 W (0.45 VA)</td> <td><b>Max. power:</b> UM-FA-9A: 200 W (1,500 VA)</td> <td><b>UM-FA-11A:</b> 200 W (1,750 VA)</td> </tr> </table> <b>Mechanical life:</b> > 20,000,000 operations <b>Electrical life (switching cycles of the output contacts, resistive load):</b> 150,000 cycles @ 1,500 VA; 1,000,000 cycles @ 450 VA; 2,000,000 cycles @ 250 VA; 5,000,000 cycles @ 125 VA  NOTE: Transient suppression is recommended when switching inductive loads. Install suppressors across load. Never install suppressors across output contacts.	<b>Min. voltage:</b> 1 V ac/dc	<b>Max. voltage:</b> 60 V		<b>Min. current:</b> 5 mA ac/dc	<b>Max. current:</b> 300 mA		<b>Min. power:</b> 5 mW (5 mVA)	<b>Max. power:</b> 7 W (7 VA)		<b>Min. voltage:</b> 15 V ac/dc	<b>Max. voltage:</b> 250 V ac/dc		<b>Min. current:</b> 30 mA ac/dc	<b>Max. current:</b> UM-FA-9A: 6 A	<b>UM-FA-11A:</b> 7 A	<b>Min. power:</b> 0.45 W (0.45 VA)	<b>Max. power:</b> UM-FA-9A: 200 W (1,500 VA)	<b>UM-FA-11A:</b> 200 W (1,750 VA)
<b>Min. voltage:</b> 1 V ac/dc	<b>Max. voltage:</b> 60 V																		
<b>Min. current:</b> 5 mA ac/dc	<b>Max. current:</b> 300 mA																		
<b>Min. power:</b> 5 mW (5 mVA)	<b>Max. power:</b> 7 W (7 VA)																		
<b>Min. voltage:</b> 15 V ac/dc	<b>Max. voltage:</b> 250 V ac/dc																		
<b>Min. current:</b> 30 mA ac/dc	<b>Max. current:</b> UM-FA-9A: 6 A	<b>UM-FA-11A:</b> 7 A																	
<b>Min. power:</b> 0.45 W (0.45 VA)	<b>Max. power:</b> UM-FA-9A: 200 W (1,500 VA)	<b>UM-FA-11A:</b> 200 W (1,750 VA)																	
Output Response Time	25 milliseconds typical																		
Input Requirements	<b>Safety input switch:</b> 2-Channel (contacts) hookup: 10 to 20 mA steady state @ 12 V dc NOTE: Inputs are designed with a brief contact-cleaning current of 100 mA when initially closed. Solid-state Dual Channel hookup: 5 to 20 mA steady state @ 18 to 28 V dc sourcing (PNP), < 2 mA leakage current Single-Channel hookup: 40 to 100 mA @ 24 V ac/dc ± 10%; 50/60 Hz <b>Reset Switch:</b> 20 mA @ 12 V dc, hard contact only																		
Minimum OFF-State Recovery Time	250 milliseconds (When used with the AG4 Safety Laser Scanner; the “Restart delay time after PF release” must be configured 280 milliseconds or greater.)																		
Indicators	<b>3 green LEDs:</b> Power ON K1 energized K2 energized																		
Construction	Polycarbonate housing																		
Environmental Rating	Rated NEMA 1; IEC IP40, Terminals IP20																		
Mounting	Mounts to standard 35 mm DIN rail track. Safety Module must be installed inside an enclosure rated NEMA 3 (IP54), or better.																		
Vibration Resistance	10 to 55 Hz @ 0.35 mm displacement per IEC 60068-2-6																		
Operating Conditions	<b>Temperature:</b> 0° to +50 °C <b>Max. Relative Humidity:</b> 90% @ +50 °C (non-condensing)																		
Design Standards	Cat. 4 PL e per EN ISO 13849-1; SIL 3 per IEC 61508 and IEC 62061																		
Certification	  <b>EMERGENCY STOP DEVICE 29YL</b>																		

# Safety Mat Monitoring

## Safety Modules



- Module monitors a single or series connection of 4-wire safety mats or safety edge devices
- Models work with AC or DC input voltages
- LED indicators show power on, output and fault
- Housings are rugged polycarbonate and mount to standard 35 mm DIN rail
- Relay outputs are capable of reliably switching low or high current applications

## Safety Mat Monitoring Modules

Supply Voltage	Inputs	Safety Outputs	Aux. Outputs	Output Rating	Output Response Time	Model
115 V ac & 12-24 V dc	1 (or multiple in series) 4-wire Safety Mat	4 NO	1 NC & 2 PNP	6 amps	50 ms	SM-GA-5A
230 V ac & 12-24 V dc	1 (or multiple in series) 4-wire Safety Mat	4 NO	1 NC & 2 PNP	6 amps	50 ms	SM-HA-5A

NC = Normally Closed Relay, NO = Normally Open Relay

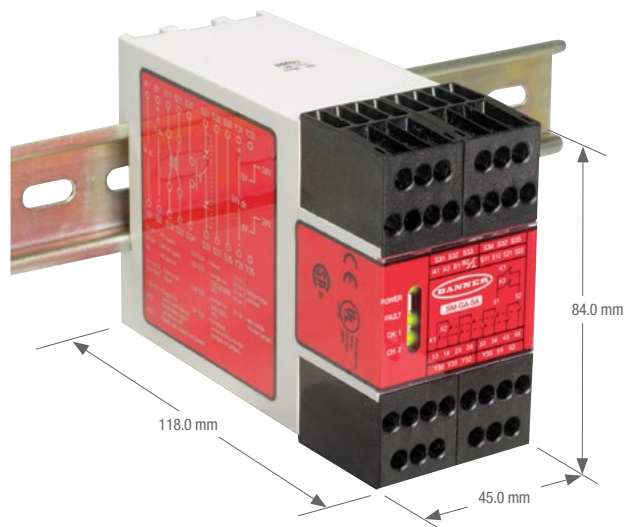

SM-..A-5A Models

Safety Mat Monitoring Module Specifications

<p><b>Supply Voltage and Current</b></p>	<p><b>AI-A2:</b> 115 V ac (model SM-GA-SA) or 230 V ac (model SM-HA-5A) ±15%, 50/60Hz  <b>BI-B2:</b> 11 V dc – 27.6 V dc  <b>Power consumption:</b> approx. 4 W/7 VA                      The Safety Module should be connected only to a SELV (safety extra-low voltage, for circuits without earth ground) or a PELV (protected extra-low voltage, for circuits with earth ground) power supply, according to EN IEC 60950, NEC Class 2</p>														
<p><b>Supply Protection Circuitry</b></p>	<p>Protected against transient voltages and reverse polarity</p>														
<p><b>Overvoltage Category</b></p>	<p><b>Output relay contact voltage of 1 V to 150 V ac/dc:</b> Category III  <b>Output relay contact voltage of 151 V to 250 V ac/dc:</b> Category III, if appropriate overvoltage reduction is provided, as described in data sheet</p>														
<p><b>Pollution Degree</b></p>	<p>2</p>														
<p><b>Output Configuration</b></p>	<p>4 normally open (NO) output channels; 1 normally closed (NC) and 2 solid-state auxiliary outputs</p> <p>Each normally open output channel is a series connection of contacts from two forced-guided (mechanically linked) relays, K1-K2. The normally closed Aux. output channel is a parallel connection of contacts from two forced-guided relays, K1-K2.</p> <p><b>Contacts:</b> AgNi, 5 µm gold-plated  <b>Low Current Rating:</b> The 5 µm gold-plated contacts allow the switching of low current/low voltage. In these low-power applications, multiple contacts can also be switched in series (e.g., “dry switching”).  <b>To preserve the gold plating on the contacts, the following max. values should not be exceeded at any time:</b></p> <table border="0"> <tr> <td><b>Minimum:</b></td> <td><b>Maximum:</b></td> </tr> <tr> <td><b>Voltage:</b> 1 V ac/dc</td> <td><b>Voltage:</b> 60 V</td> </tr> <tr> <td><b>Current:</b> 5 mA ac/dc</td> <td><b>Current:</b> 300 mA</td> </tr> <tr> <td><b>Power:</b> 5 mW (5 mVA)</td> <td><b>Power:</b> 7 W (7 VA)</td> </tr> </table> <p><b>High Current Rating: If higher loads must be switched through one or more of the contacts, the minimum and maximum values of the contact(s) change to:</b></p> <table border="0"> <tr> <td></td> <td><b>Minimum:</b> <b>Voltage:</b> 15 V ac/dc <b>Current:</b> 250 mA ac/dc <b>Power:</b> 5 W (5 VA)</td> <td><b>Maximum:</b> NO Safety Contacts (13-14, 23-24, 33-34, 43-44): 250 V ac/ 24 V dc, 6A resistive B300, Q300 (UL508) NC Auxiliary Contact (51-52): 250 V ac/ 24 V dc, 5A resistive B300, Q300 (UL508)</td> </tr> <tr> <td></td> <td><b>Minimum:</b> <b>Voltage:</b> 15 V ac/dc <b>Current:</b> 250 mA ac/dc <b>Power:</b> 5 W (5 VA)</td> <td><b>Maximum—IEC60947-5-1</b> <b>NO Safety Contact:</b> AC-1: 250 V ac, 6A; DC-1: 24 V dc, 6A AC-15: 230 V ac, 3A; DC-13: 24 V dc, 4A <b>NC Auxiliary Contact:</b> AC-1: 250 V ac, 5A; DC-1: 24 V dc, 5A AC-15: 230 V ac, 2A; DC-13: 24 V dc, 4A</td> </tr> </table> <p></p> <p><b>Mechanical life:</b> &gt;20,000,000 operations  <b>Electrical life:</b> 150,000 cycles @ 1500 VA; 1,000,000 cycles @ 450 VA; 2,000,000 cycles @ 250 VA; 5,000,000 cycles @ 125 VA</p> <p>NOTE: Transient suppression is recommended when switching inductive loads. Install suppressors across load. Never install suppressors across output contacts.</p> <p><b>Solid-State Monitor Outputs:</b></p> <ul style="list-style-type: none"> <li>- Two non-safety solid-state dc outputs</li> <li>- Output at Y32 monitors state of outputs – conducts (output high) when both K1 and K2 are energized</li> <li>- Output at Y35 conducts (output high) when in normal operation (no lockout)</li> <li>- Output circuits require application of +12-24 V dc ±15% at terminal Y31; dc common at Y30</li> <li>- Maximum switching current: 100 mA at +12-24 V dc</li> <li>- Both outputs are protected against short circuits</li> </ul>	<b>Minimum:</b>	<b>Maximum:</b>	<b>Voltage:</b> 1 V ac/dc	<b>Voltage:</b> 60 V	<b>Current:</b> 5 mA ac/dc	<b>Current:</b> 300 mA	<b>Power:</b> 5 mW (5 mVA)	<b>Power:</b> 7 W (7 VA)		<b>Minimum:</b> <b>Voltage:</b> 15 V ac/dc <b>Current:</b> 250 mA ac/dc <b>Power:</b> 5 W (5 VA)	<b>Maximum:</b> NO Safety Contacts (13-14, 23-24, 33-34, 43-44): 250 V ac/ 24 V dc, 6A resistive B300, Q300 (UL508) NC Auxiliary Contact (51-52): 250 V ac/ 24 V dc, 5A resistive B300, Q300 (UL508)		<b>Minimum:</b> <b>Voltage:</b> 15 V ac/dc <b>Current:</b> 250 mA ac/dc <b>Power:</b> 5 W (5 VA)	<b>Maximum—IEC60947-5-1</b> <b>NO Safety Contact:</b> AC-1: 250 V ac, 6A; DC-1: 24 V dc, 6A AC-15: 230 V ac, 3A; DC-13: 24 V dc, 4A <b>NC Auxiliary Contact:</b> AC-1: 250 V ac, 5A; DC-1: 24 V dc, 5A AC-15: 230 V ac, 2A; DC-13: 24 V dc, 4A
<b>Minimum:</b>	<b>Maximum:</b>														
<b>Voltage:</b> 1 V ac/dc	<b>Voltage:</b> 60 V														
<b>Current:</b> 5 mA ac/dc	<b>Current:</b> 300 mA														
<b>Power:</b> 5 mW (5 mVA)	<b>Power:</b> 7 W (7 VA)														
	<b>Minimum:</b> <b>Voltage:</b> 15 V ac/dc <b>Current:</b> 250 mA ac/dc <b>Power:</b> 5 W (5 VA)	<b>Maximum:</b> NO Safety Contacts (13-14, 23-24, 33-34, 43-44): 250 V ac/ 24 V dc, 6A resistive B300, Q300 (UL508) NC Auxiliary Contact (51-52): 250 V ac/ 24 V dc, 5A resistive B300, Q300 (UL508)													
	<b>Minimum:</b> <b>Voltage:</b> 15 V ac/dc <b>Current:</b> 250 mA ac/dc <b>Power:</b> 5 W (5 VA)	<b>Maximum—IEC60947-5-1</b> <b>NO Safety Contact:</b> AC-1: 250 V ac, 6A; DC-1: 24 V dc, 6A AC-15: 230 V ac, 3A; DC-13: 24 V dc, 4A <b>NC Auxiliary Contact:</b> AC-1: 250 V ac, 5A; DC-1: 24 V dc, 5A AC-15: 230 V ac, 2A; DC-13: 24 V dc, 4A													
<p><b>Output Response Time</b></p>	<p>35 milliseconds max, 25 milliseconds typical</p>														
<p><b>Input Requirements</b></p>	<p>Safety mat normally open contact must be capable of switching 20 to 100 mA @ 12 to 30 V dc; and must be closed &gt; 25 ms for a valid stop command  <b>115/230 V ac or 24 V dc:</b> Maximum input resistance 250 ohms per lead; maximum contact resistance: 150 ohms  <b>12 V dc Supply:</b> Maximum input resistance 25 ohms; maximum contact resistance: 10 ohms  <b>Reset switch:</b> must have one normally open contact capable of switching 20 to 50 mA @ 12 to 30 V dc</p>														
<p><b>OFF-State Recovery Time</b></p>	<p>350 ms max.</p>														
<p><b>Status Indicators</b></p>	<p><b>3 green LED indicators:</b> Power ON, Channel 1 (high side), Channel 2 (low side)      <b>1 red LED indicator:</b> indicates a fault condition</p>														
<p><b>Construction</b></p>	<p>Polycarbonate housing</p>														
<p><b>Environmental Rating</b></p>	<p>Rated NEMA 1; IEC IP20</p>														
<p><b>Mounting</b></p>	<p>Mounts to standard 35 mm DIN rail track. Safety Module must be installed inside an enclosure rated NEMA 3 (IP54) or better.</p>														
<p><b>Vibration Resistance</b></p>	<p>10 to 60 Hz @ 0.35 mm displacement per UL 991      60 to 150 Hz @ 5 g max.</p>														
<p><b>Operating Conditions</b></p>	<p><b>Temperature:</b> 0° to +50 °C      <b>Relative humidity:</b> 90% @ +50 °C (non-condensing)</p>														
<p><b>Design Standards</b></p>	<p>Cat. 4, PL e per EN ISO 13849-1; SIL 3 per IEC 61508 and IEC 62061 (Cat 3 with Safety Mat)</p>														
<p><b>Certifications</b></p>	<p>  </p>														

# Muting Module

## Safety Modules



- Muting Modules suspend safeguarding during non-hazardous times in the machine's cycle, allowing material to move into or from the process without tripping the muted safeguard
- Monitors hard-relay contact or PNP output safety devices
- Suitable for Type 4 (Category 4) applications
- Connects to supplemental safeguarding devices or E-Stops
- Can be used as a Dual Controller for safety devices, such as two Safety Light Screens, regardless of whether or not the muting function is used
- Housings are rugged polycarbonate and mount to standard 35 mm DIN rail
- Relay outputs are capable of reliably switching low or high current applications

## Muting Modules

Input Device	Supply Voltage	Inputs	Safety Outputs	Aux. Outputs	Output Rating	Output Response Time	Model
Electromechanical & Solid State	24 V dc	2 NC Muteable (dual) & 2 NC SSI (dual)	2 PNP OSSD	1 PNP	0.5 amps	10 ms	MMD-TA-12B
Electromechanical & Solid State	24 V dc	2 NC Muteable (dual) & 2 NC SSI (dual)	2 NO	1 NC	6 amps	20 ms	MMD-TA-11B

NC = Normally Closed Relay, NO = Normally Open Relay



MMD-TA-11B & MMD-TA-12B Muting Modules  
(MMD-TA-12B shown)



MMD-TA-12B & MMD-TA-11B Muting Modules Specifications



System Power Requirements	<p><b>MMD-TA-11B:</b> +24 V dc <math>\pm</math>15% @ 300 mA max (SELV/PELV)  <b>MMD-TA-12B:</b> +24 V dc <math>\pm</math>15% @ 250 mA max (SELV/PELV)                  (not including draw of the MSSSI power, AUX, ML, M1-M4 and OSSD connections)                  The external voltage supply must be capable of buffering brief mains interruptions of 20 milliseconds, as specified in IEC/EN 60204-1</p>												
Overvoltage Category	III (IEC 60664-1)												
Pollution Degree	2												
Supply Protection Circuitry	All inputs and outputs are protected from short circuit to +24 V dc or dc common												
Response Time (MSSI and SSI)	<p><b>MMD-TA-12B:</b> (solid-state output) 20 milliseconds max.  <b>MMD-TA-11B:</b> (relay output) 10 milliseconds max.</p>												
Safety Outputs	<p><b>MMD-TA-11B:</b>                  2 normally open contact output channels and 1 normally closed auxiliary contact output channel: Each normally open output channel is a series connection of contacts from two forced-guided (positive-guided) relays, K1-K2. The normally closed AUX contact (non-safety) 31-32 is a parallel connection of contacts from K1-K2.</p> <p><b>Contacts:</b> AgNi, 5 <math>\mu</math>m gold-plated</p> <p><b>Low Current Rating:</b>  <b>Caution: The 5 <math>\mu</math>m gold-plated contacts allow the switching of low current/low voltage.</b>                  In these low-power applications, multiple contacts can also be switched in series (e.g., "dry switching"). To preserve the gold plating on the contacts and also guarantee reliable switching, the following values should be kept within the min. and max. ranges shown below.</p> <table border="0" style="width: 100%;"> <tr> <td style="text-align: center;"><b>Min. voltage:</b> 1 V ac/dc</td> <td style="text-align: center;"><b>Max. voltage:</b> 60 V</td> </tr> <tr> <td style="text-align: center;"><b>Min. current:</b> 5 mA ac/dc</td> <td style="text-align: center;"><b>Max. current:</b> 300 mA</td> </tr> <tr> <td style="text-align: center;"><b>Min. power:</b> 5 mW (5 mVA)</td> <td style="text-align: center;"><b>Max. power:</b> 7 W (7 VA)</td> </tr> </table> <p><b>High Current Rating:</b>                  If higher loads must be switched through one or more of the contacts, the minimum and maximum values of the contact(s) changes to:</p> <table border="0" style="width: 100%;"> <tr> <td style="text-align: center;"><b>Min. voltage:</b> 15 V ac/dc</td> <td style="text-align: center;"><b>Max. voltage:</b> 120 V ac/dc</td> </tr> <tr> <td style="text-align: center;"><b>Min. current:</b> 30 mA ac/dc</td> <td style="text-align: center;"><b>Max. current:</b> 6 A</td> </tr> <tr> <td style="text-align: center;"><b>Min. power:</b> 0.45 W (0.45 VA)</td> <td style="text-align: center;"><b>Max. power:</b> 160 W (720 VA)</td> </tr> </table> <p><b>Mechanical life:</b> 50,000,000 operations  <b>Electrical life:</b> 120,000 operations (typical at 144 W/[1380 VA] switched power, resistive load)</p> <p><b>NOTE: Transient suppression is recommended when switching inductive loads. Install suppressors across load. Never install suppressors across output contacts</b></p> <p><b>MMD-TA-12B:</b>  <b>Two diverse-redundant solid-state safety outputs:</b> 24 V dc, 0.5 A sourcing OSSD (output signal switching device)</p> <p><b>ON-State voltage:</b> <math>\geq</math>V in-1.5 V dc  <b>OFF-State voltage:</b> 1.2 V dc max. ( 0-1 2 V dc)  <b>Max. load capacitance:</b> 0.1 <math>\mu</math>F  <b>Max. load inductance:</b> 10 H  <b>Leakage current:</b> 0.50 mA max.  <b>Cable resistance:</b> 10 <math>\Omega</math> max.  <b>OSSD test pulse width:</b> &lt; 100 microseconds  <b>OSSD test pulse period:</b> &gt; 100 milliseconds  <b>Switching current:</b> 0-0.5 A</p>	<b>Min. voltage:</b> 1 V ac/dc	<b>Max. voltage:</b> 60 V	<b>Min. current:</b> 5 mA ac/dc	<b>Max. current:</b> 300 mA	<b>Min. power:</b> 5 mW (5 mVA)	<b>Max. power:</b> 7 W (7 VA)	<b>Min. voltage:</b> 15 V ac/dc	<b>Max. voltage:</b> 120 V ac/dc	<b>Min. current:</b> 30 mA ac/dc	<b>Max. current:</b> 6 A	<b>Min. power:</b> 0.45 W (0.45 VA)	<b>Max. power:</b> 160 W (720 VA)
<b>Min. voltage:</b> 1 V ac/dc	<b>Max. voltage:</b> 60 V												
<b>Min. current:</b> 5 mA ac/dc	<b>Max. current:</b> 300 mA												
<b>Min. power:</b> 5 mW (5 mVA)	<b>Max. power:</b> 7 W (7 VA)												
<b>Min. voltage:</b> 15 V ac/dc	<b>Max. voltage:</b> 120 V ac/dc												
<b>Min. current:</b> 30 mA ac/dc	<b>Max. current:</b> 6 A												
<b>Min. power:</b> 0.45 W (0.45 VA)	<b>Max. power:</b> 160 W (720 VA)												

Continued on next page

## MMD-TA-12B &amp; MMD-TA-11B Muting Modules Specifications (cont'd)

Non-Safety Outputs	<p><b>Model MMD-TA-11B:</b> Aux. output 31–32 is a parallel connection of two N.C. contacts from internal relays K1 and K2 <b>Contact:</b> AgNi, 5 µm gold-plated <b>Low Current Rating:</b> <b>Caution: The 5 µm gold-plated contacts allow the switching of low current/low voltage.</b> To preserve the gold plating on the contacts and also guarantee reliable switching, the following values should be kept within the min. and max. ranges shown below:</p> <table border="0"> <tr> <td><b>Min. Voltage:</b> 1 V ac/dc</td> <td><b>Max. Voltage:</b> 24 V ac/dc</td> </tr> <tr> <td><b>Min. Current:</b> 5 mA ac/dc</td> <td><b>Max. Current:</b> 250 mA ac/dc</td> </tr> <tr> <td><b>Min. Power:</b> 5 mW (5 mVA)</td> <td><b>Max. Power:</b> 6 W (6 VA)</td> </tr> </table> <p><b>High Current Rating:</b> For higher loads, the min. and max. values of the contact(s) changes to:</p> <table border="0"> <tr> <td><b>Min. Voltage:</b> 15 V ac/dc</td> <td><b>Max. Voltage:</b> 120 V ac/dc</td> </tr> <tr> <td><b>Min. Current:</b> 30 mA ac/dc</td> <td><b>Max. Current:</b> 6 A</td> </tr> <tr> <td><b>Min. Power:</b> 0.45 W (0.45 VA)</td> <td><b>Max. Power:</b> 160 W/720 VA</td> </tr> </table> <p><b>Mechanical Life:</b> 50,000,000 operations Electrical Life: &gt;10 x 10<sup>6</sup> cycles</p> <p><b>Model MMD-TA-12B:</b> Z4–Z3 = Aux. 24 V / 250 mA PNP output follows the two OSSD safety outputs</p>	<b>Min. Voltage:</b> 1 V ac/dc	<b>Max. Voltage:</b> 24 V ac/dc	<b>Min. Current:</b> 5 mA ac/dc	<b>Max. Current:</b> 250 mA ac/dc	<b>Min. Power:</b> 5 mW (5 mVA)	<b>Max. Power:</b> 6 W (6 VA)	<b>Min. Voltage:</b> 15 V ac/dc	<b>Max. Voltage:</b> 120 V ac/dc	<b>Min. Current:</b> 30 mA ac/dc	<b>Max. Current:</b> 6 A	<b>Min. Power:</b> 0.45 W (0.45 VA)	<b>Max. Power:</b> 160 W/720 VA
<b>Min. Voltage:</b> 1 V ac/dc	<b>Max. Voltage:</b> 24 V ac/dc												
<b>Min. Current:</b> 5 mA ac/dc	<b>Max. Current:</b> 250 mA ac/dc												
<b>Min. Power:</b> 5 mW (5 mVA)	<b>Max. Power:</b> 6 W (6 VA)												
<b>Min. Voltage:</b> 15 V ac/dc	<b>Max. Voltage:</b> 120 V ac/dc												
<b>Min. Current:</b> 30 mA ac/dc	<b>Max. Current:</b> 6 A												
<b>Min. Power:</b> 0.45 W (0.45 VA)	<b>Max. Power:</b> 160 W/720 VA												
Status Indicators	<p><b>3 Status LEDs (Red, Green and Yellow):</b> indicate waiting for Reset, Lockout, Override, and OSSD status Yellow and Green LEDs adjacent to individual inputs/interfaces indicate status (ON = active/closed)</p>												
Diagnostic Code Display	<p>Diagnostic Display is a two-digit numeric display that indicates the cause of lockout conditions and the amount of time remaining for the backdoor timer</p>												
Muting Lamp Output	<p>A monitored or non-monitored (selectable) sinking output. If monitoring has been selected, the current draw must be 10 to 360 mA. Interconnect wire resistance &lt; 30 Ω.</p> <p><b>Max. switching voltage:</b> 30 V dc <b>Max. switching current:</b> 360 mA <b>Min. switching current:</b> 10 mA</p> <p><b>Saturation voltage:</b> ≤ 1.5 V dc @ 10 mA; ≤ 5 V dc @ 360 mA</p>												
Controls and Adjustments	<p><b>All configured on two redundant banks of DIP switches:</b></p> <ul style="list-style-type: none"> <li>Manual/auto reset</li> <li>One-way/two-way muting</li> <li>Monitored/non-monitored mute lamp output</li> <li>One-channel/two-channel/no EDM</li> <li>Backdoor timer</li> <li>Mute on power-up enable</li> </ul>												
Inputs	<p>The MSSl and the SSl can be interfaced with external safety devices that have either hard contact outputs or solid-state sourcing outputs</p> <p>When connecting the MSSl (S11-S12, S21-S22) or SSl (X5-X6, X7-X8) inputs to safety relay outputs or hard contacts, these contacts must be capable of switching 15 to 30 V dc at 10-50 mA</p> <p><b>Operating Range for MSSl and SSl Inputs</b> <b>OFF State:</b> –3 V to +5 V, 0 to 2 mA <b>ON State:</b> 15-30 V, 10-50 mA</p> <p><b>Muteable Safety Stop Interface (MSSl)</b> This input consists of two channels (MSSl-A and MSSl-B), and can be muted when the requirements for a mute cycle have been met. When muted, the OSSDs remain ON, independent of the MSSl status. If not muted, when either or both channels open, the OSSD outputs will go OFF. Maximum external resistance per channel must not exceed 400 Ω.</p> <p><b>Safety Stop Interface (SSl)</b> This input consists of two channels (SSl-A and SSl-B), and is always active. When one or both channels open, the OSSD Outputs will go OFF. Maximum external resistance per channel must not exceed 400 Ω.</p>												
External Device Monitoring (EDM)	<p>Two pairs of terminals are provided to monitor the state of external devices controlled by the OSSD outputs. Each device must be capable of switching 15-30 V dc at 10-50 mA.</p>												
Muting Device Inputs	<p>The muting devices work in pairs (M1 and M2, M3 and M4) and are required to be “closed” within 3 seconds of each other (simultaneity requirement/synchronous actuation) to initiate a mute (assuming all other conditions are met). Each muting device must be capable of switching 15-30 V dc at 10-50 mA.</p>												
Mute Enable Input	<p>The mute enable input must have +24 V dc applied in order to start a mute; opening this input after mute has begun has no effect. The switching device must be capable of switching 15-30 V dc at 10-50 mA.</p>												

MMD-TA-12B & MMD-TA-11B Muting Modules Specifications (cont'd)

<b>Override Inputs</b>	The two-channel inputs must be closed within 3 seconds of each other (simultaneity/synchronous action requirement) and held closed during the 30-second Override. To initiate a subsequent Override, open both channels, wait 3 seconds, and then re-close both channels (within 3 seconds). The switching devices must be capable of switching 15-30 V dc at 10-50 mA.
<b>Reset Input</b>	Terminals must be closed for a minimum of 0.25 seconds and not more than 2.0 seconds in order to guarantee a reset. The switching device must be capable of switching 15-30 V dc at 10-50 mA.
<b>Mounting</b>	Mounts to standard 35 mm DIN rail track. Safety Module must be installed inside an enclosure rated NEMA 3 (IP54), or better.
<b>Vibration Resistance</b>	10 to 55 Hz @ 0.35 mm displacement per IEC 60068-2-6
<b>Construction</b>	Polycarbonate housing
<b>Connections</b>	Removable terminal blocks
<b>Environmental Rating</b>	NEMA 1; IP20
<b>Operating Conditions</b>	<b>Temperature range:</b> 0° to +50 °C <b>Relative humidity:</b> 95% (non-condensing)
<b>Design Standards</b>	Designed to comply with Safety Category 4 per SIL 3 (IEC 61508); SIL CL3 (IEC 62061); Category 4, Performance Level (PL) e (ISO 13849-1)
<b>Certifications</b>	 

# Safe Speed Monitoring

## Safety Modules

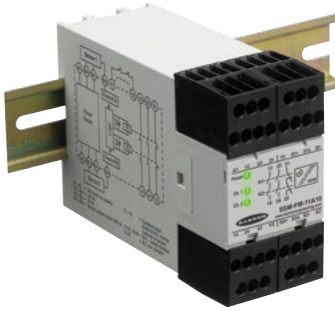

- Safe Speed Safety Modules monitor redundant devices, such as two sensors with PNP outputs for rotation and linear movements allowing locked gates or guards to be opened when speed drops below or above the dangerous level
- Each module has four adjustable RPM ranges
- Provides two normally open safety contacts and one normally closed auxiliary contact, each rated at 4 amps
- Housings are rugged polycarbonate and mount to standard 35 mm DIN rail

### SSM Safe Speed Monitoring Modules

Supply Voltage	Inputs	Safety Outputs	Aux. Outputs	Ranges (lpm)	Output Rating	Model
24 V ac/dc	2 PNP	2 NO	1 NC	5 - 40, 35 - 340, 300 - 2700, 1200 - 10500	4 amps	<b>SSM-FM-11A10</b>
24 V ac/dc	2 PNP	2 NO	1 NC	10 - 80, 80 - 650, 600 - 5300, 2400 - 20000	4 amps	<b>SSM-FM-11A20</b>

NC = Normally Closed Relay, NO = Normally Open Relay

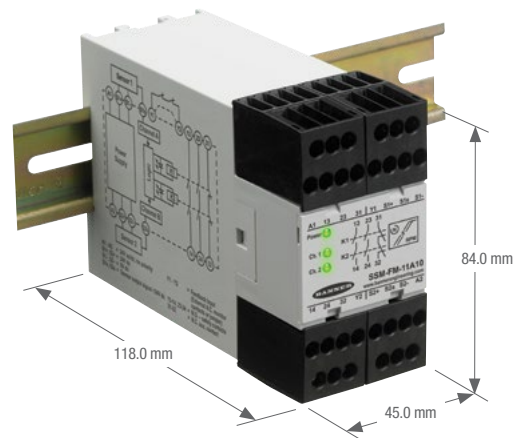

SSM-FM-11A... Models

## SSM Safe Speed Monitoring Module Specifications

Supply Voltage and Current	24 V ac/dc, 50-60 Hz, no polarity AC: 24 V +10% / -15% DC: 24 V ±10% Power consumption: approx. 4 VA/2.5 W
Start-up Reset Time	1.5 second
Hysteresis	6% typical
Input Requirements	<b>PNP-Input sensors:</b> 24 V dc (terminals S1s and S2s) <b>Input current min.:</b> 3 mA <b>Input current max.:</b> 25 mA <b>Min. pulse time:</b> 1 millisecond ON; 1 millisecond OFF
Max. IPM at Inputs S1s and S2s	30,000
Adjustable Setting Ranges (Impulses per Minute)	<b>SSM-FM-11A10:</b> 5...40 ipm, 35...340 ipm, 300...2,700 ipm or 1,200...10,500 ipm <b>SSM-FM-11A20:</b> 10...80 ipm, 80...650 ipm, 600...5,300 ipm or 2,400...20,000 ipm
Output Response Time	<b>Standstill / Under-speed detection:</b> (60 seconds/adjusted IPM value) + 2.5 seconds = tDS tDS = output ON-delay after detection of standstill  <b>Over-speed detection:</b> <b>SSM-FM-11A10:</b> Range 5...10,500: tR = 700 milliseconds typical <b>SSM-FM-11A20:</b> Range 10...20,000: tR = 350 milliseconds typical
Output Configuration	<b>Outputs K1 &amp; K2:</b> two redundant (total of four) safety relay NO (forced-guided) contacts—AgNi, gold flashed; one auxiliary NC contact—AgNi, gold flashed  <b>Contact ratings (all NO and NC output contacts):</b> 2 normally open (NO) output channels and 1 normally closed (NC) auxiliary output  <b>Current Rating:</b> <b>Thermal Current Ith:</b> 4 A <b>Switching Capacity to AC 15:</b> 3 A / 230 V ac for NO contacts (per IEC/EN 60947-5-1) 2 A / 230 V ac for NC contact (per IEC/EN 60947-5-1) <b>Min. voltage:</b> 15 V ac/dc <b>Min. current:</b> 30 mA ac/dc <b>Min. power:</b> 0.45 W (0.45 VA) <b>Max. voltage:</b> 230 V ac/dc <b>Max. current:</b> 4 A <b>Max. power:</b> 100 W (92 VA)  <b>Mechanical Life:</b> ≥50,000,000 operations <b>Electrical life (switching cycles of the output contacts, resistive load):</b> 350,000 cycles @ 920 VA; 1,000,000 cycles @ 440 VA; 2,000,000 cycles @ 250 VA; 5,000,000 cycles @ 125 VA  NOTE: Transient suppression is recommended when switching inductive loads. Install suppressor across load. Never install suppressor across output contacts.
Indicators	<b>3 green LED indicators:</b> Power On, Channel 1 active, and Channel 2 active
Construction	Polycarbonate housing
Environmental Rating	Rated NEMA 1; IEC IP20 (IEC/EN 60529)
Mounting	Mounts to standard 35 mm DIN rail track. Safety Module must be installed inside an enclosure rated NEMA 3 (IEC IP54) or better.
Vibration Resistance	10 to 55 Hz @ 0.35 mm displacement per IEC 60068-2-6
Operating Conditions	<b>Temperature:</b> 0° to 50 °C <b>Max. Rel. Humidity:</b> 90% @ +50 °C (non-condensing)
Design Standards	Cat. 3 PL e per DIN EN ISO 13849-1; SIL CL 3 per IEC 62061
Certifications	Approvals are pending  This module was evaluated by UL to UL508 Industrial Control Equipment, which is not a certification relating to the safety performance of the module

# Interface Relay Modules

## Safety Modules



- Interface relay modules serve as a relay for safety devices with OSSD solid-state or hard contact outputs and external device monitoring, such as the EZ-SCREEN®
- Increases the switching current capacity of low-voltage safety devices up to 6 amps
- Requires no adjustment
- Housings are rugged polycarbonate and mount to standard 35 mm DIN rail
- Relay outputs are capable of reliably switching low or high current applications

## Interface Modules

Supply Voltage	Inputs	Safety Outputs	Aux. Outputs	Output Rating	Output Response Time	Models
24 V dc	2 NC (dual)	3 NO	—	6 amps	20 ms	IM-T-9A
24 V dc	2 NC (dual)	2 NO	1 NC	6 amps	20 ms	IM-T-11A

NC = Normally Closed Relay, NO = Normally Open Relay

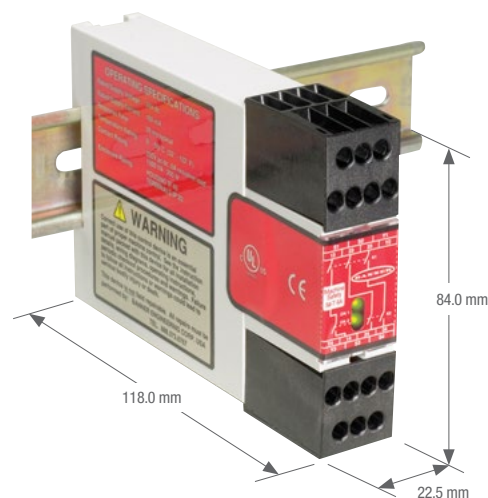

Interface Models

## Interface Modules Specifications

Input Voltage and Current	24 V dc, +/-15% no polarity, 10% max. ripple; 50 mA per input channel Power consumption: approx. 2.4 W																				
Supply Protection Circuitry	Protected against transient voltages																				
Overvoltage Category	Output relay contact voltage of 1 V to 150 V ac/dc: Category III Output relay contact voltage of 151 V to 250 V ac/dc: Category II (Category III, if appropriate overvoltage reduction is provided, as described in data sheet.)																				
Pollution Degree	2																				
Output Configuration	<p><b>IM-T-9A:</b> 3 normally open output channels  <b>IM-T-11A:</b> 2 normally open output channels and 1 normally closed auxiliary output channel  Each normally open output channel is a series connection of contacts from two forced-guided (mechanically linked) relays, K1-K2.  The normally closed contact 31-32 is a parallel connection of contacts from K1-K2.  <b>Contacts:</b> AgNi, 5 µm gold-plated</p> <p><b>Low Current Rating:</b> The 5 µm gold-plated contacts allow the switching of low current/low voltage. In these low-power applications, multiple contacts can also be switched in series (e.g., "dry switching"). To preserve the gold plating on the contacts, do not exceed the following max. values at any time:</p> <table border="0"> <tr> <td><b>Min. voltage:</b> 1 V ac/dc</td> <td><b>Max. voltage:</b> 60 V</td> </tr> <tr> <td><b>Min. current:</b> 5 mA ac/dc</td> <td><b>Max. current:</b> 300 mA</td> </tr> <tr> <td><b>Min. power:</b> 5 mW (5 mVA)</td> <td><b>Max. power:</b> 7 W (7 VA)</td> </tr> </table> <p><b>High Current Rating:</b> If higher loads must be switched through one or more of the contacts, the minimum and maximum values of the contact(s) changes to:</p> <table border="0"> <tr> <td><b>Min. voltage:</b> 15 V ac/dc</td> <td><b>Max. voltage:</b> 250 V ac/dc, 6A resistive</td> </tr> <tr> <td><b>Min. current:</b> 30 mA ac/dc</td> <td><b>Max. power:</b> 150 W (1,500 VA)</td> </tr> <tr> <td><b>Min. power:</b> 0.45 W (0.45 VA)</td> <td>IEC 60947-5-1:</td> </tr> <tr> <td></td> <td><b>AC-15:</b> 230 V ac, <b>3A:</b> <b>DC-13:</b> 24 V dc, 4 A</td> </tr> </table> <p><b>Mechanical life:</b> 20,000,000 operations  <b>Electrical life:</b> 150,000 cycles @ 1500 VA; 1,000,000 cycles @ 450 VA; 2,000,000 cycles @ 250 VA; 5,000,000 VA @ 125 VA</p> <p><b>Feedback contact rating (Y1-Y2, Y3-Y4):</b></p> <table border="0"> <tr> <td><b>Min. voltage:</b> 1 V ac/dc</td> <td><b>Max. voltage:</b> 60 V</td> </tr> <tr> <td><b>Min. current:</b> 5 mA ac/dc</td> <td><b>Max. current:</b> 300 mA</td> </tr> <tr> <td><b>Min. power:</b> 5 mW (5 mVA)</td> <td><b>Max. power:</b> 7 W (7 VA)</td> </tr> </table> <p>NOTE: Transient suppression is recommended when switching inductive loads. Install suppressors across load. Never install suppressors across output contacts.</p>	<b>Min. voltage:</b> 1 V ac/dc	<b>Max. voltage:</b> 60 V	<b>Min. current:</b> 5 mA ac/dc	<b>Max. current:</b> 300 mA	<b>Min. power:</b> 5 mW (5 mVA)	<b>Max. power:</b> 7 W (7 VA)	<b>Min. voltage:</b> 15 V ac/dc	<b>Max. voltage:</b> 250 V ac/dc, 6A resistive	<b>Min. current:</b> 30 mA ac/dc	<b>Max. power:</b> 150 W (1,500 VA)	<b>Min. power:</b> 0.45 W (0.45 VA)	IEC 60947-5-1:		<b>AC-15:</b> 230 V ac, <b>3A:</b> <b>DC-13:</b> 24 V dc, 4 A	<b>Min. voltage:</b> 1 V ac/dc	<b>Max. voltage:</b> 60 V	<b>Min. current:</b> 5 mA ac/dc	<b>Max. current:</b> 300 mA	<b>Min. power:</b> 5 mW (5 mVA)	<b>Max. power:</b> 7 W (7 VA)
<b>Min. voltage:</b> 1 V ac/dc	<b>Max. voltage:</b> 60 V																				
<b>Min. current:</b> 5 mA ac/dc	<b>Max. current:</b> 300 mA																				
<b>Min. power:</b> 5 mW (5 mVA)	<b>Max. power:</b> 7 W (7 VA)																				
<b>Min. voltage:</b> 15 V ac/dc	<b>Max. voltage:</b> 250 V ac/dc, 6A resistive																				
<b>Min. current:</b> 30 mA ac/dc	<b>Max. power:</b> 150 W (1,500 VA)																				
<b>Min. power:</b> 0.45 W (0.45 VA)	IEC 60947-5-1:																				
	<b>AC-15:</b> 230 V ac, <b>3A:</b> <b>DC-13:</b> 24 V dc, 4 A																				
<b>Min. voltage:</b> 1 V ac/dc	<b>Max. voltage:</b> 60 V																				
<b>Min. current:</b> 5 mA ac/dc	<b>Max. current:</b> 300 mA																				
<b>Min. power:</b> 5 mW (5 mVA)	<b>Max. power:</b> 7 W (7 VA)																				
Output Response Time	20 milliseconds max.																				
Status Indicators	<b>2 green LED indicators:</b> K1 energized    K2 energized																				
Construction	Polycarbonate housing																				
Environmental Rating	Rated NEMA 1; IEC IP20																				
Mounting	Mounts to standard 35 mm DIN rail track. Interface Module must be installed inside an enclosure rated NEMA 3 (IP54), or better.																				
Vibration Resistance	10 to 55Hz @ 0.35 mm displacement per IEC 60068-2-6																				
Operating Conditions	<b>Temperature:</b> 0° to +50 °C <b>Relative humidity:</b> 90% @ 50 °C (non-condensing)																				
Design Standards	EN 60204-1, IEC 61810-1, EN 60255-1, EN 50205																				
Application Notes	There are no adjustments or user-serviceable parts.																				
Certifications																					

# Extension Relay Modules

## Safety Modules



- Extension Relay Modules provide additional safety outputs for a safety modules with relay contact outputs and external device monitoring
- Provides delayed or immediate outputs, depending on model
- Requires no adjustment
- Housings are rugged polycarbonate and mount to standard 35 mm DIN rail

## Extension Modules

Supply Voltage	Inputs	Safety Outputs	Output Rating	Aux. Outputs	Output Response Time	Delay	Model
24 V dc	1 NC (single) or 2 NC (dual)	4 NO	6 amps	—	20 ms	—	EM-T-7A
24 V ac/dc	1 NC (single)	4 NO	6 amps	—	35 ms	—	EM-F-7G
24 V ac/dc	1 NC (single)	4 NO w/delay	6 amps	—	—	0.5 sec.	EM-FD-7G2
24 V ac/dc	1 NC (single)	4 NO w/delay	6 amps	—	—	1.0 sec.	EM-FD-7G3
24 V ac/dc	1 NC (single)	4 NO w/delay	6 amps	—	—	2.0 sec.	EM-FD-7G4

NC = Normally Closed Relay, NO = Normally Open Relay

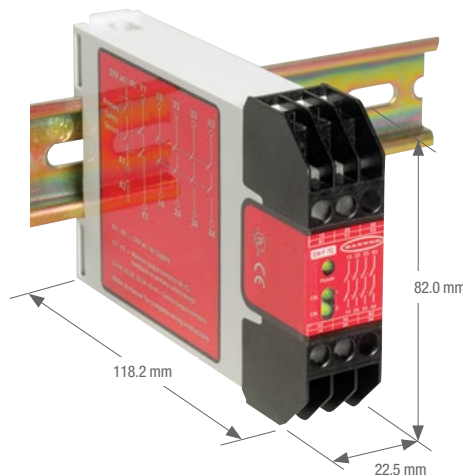

EM-F-7G Models



EM-T-7A Models





# ACCESSORIES

---



---

BRACKETS **page 722**











CORDSETS **page 758**

RETROREFLECTORS **page 790**

MISCELLANEOUS **page 802**









Banner Bracket Selection Chart

**SENSORS**

Q4X page 30		SMB18A page 732	SMBAMS18P page 735	SMBAMS18RA page 735	SMBQ4XFA.. page 755			
Q3X page 38		SMB18FA.. page 733	SMB18A page 732	SMBQ4XFA.. page 755				
Q518 page 40		SMB18A page 732	SMB18FA.. page 733	SMB18ATFA page 732	SMB18FM page 733	SMB18Q page 733	SMB18SF page 733	SMB18UR page 733
		SMB30SUS page 734	SMB312S page 734	SMB46A page xxx	SMB46L page 734	SMB46S page 734	SMB46U page 735	SMBAMS18P page 735
		SMB3018SC page 733	SMB30SK page 733	SMB312PD page 734	SMBQS18RA page 735	SMBQS18Y page 735	SMB4050YL page 734	SMB18FVK
		SMBAMS18RA page 735	SMBQS18A page 735	SMBQS18DIN page 735	SMH241F page 735	SMB18S	SMB18C	SMBQS18VP6LPQ
		SMB18RAVK						
Q530 page 56		SMB30MM page 737	SMB30Q page 737	SMB30RAVK page 737	SMB30SC page 738	SMB46L page 734	SMB46S page 734	SMBAMS30P page 738
		SMBAMS30RA page 738	SMBAMSRAB page 738	SMBQS30L page 738	SMBQS30LT page 738	SMBQS30Y page 738	SMBQS30YL page 738	SMB30A page 737
		SMB30FA page 737	SMB30S	SMB30C	SMB30FVK	SMB30SM		
Q12 page 66		SMBQ12A page 732	SMBQ12T page 732	SMBQ12S				
Q20 page 70		SMBQ20H page 736	SMBQ20L page 736	SMBQ20LV page 736	SMBQ20U page 736			
Q45/Q45U page 84		SMB30A page 737	SMB30FA.. page 737	SMB30MM page 737	SMB30Q page 737	SMB30RAVK page 737	SMB30SC page 737	SMB30UR page 739
		SMBAMS30P page 738	SMBAMS30RA page 738	SMB30C	SMB30FVK	SMB30S	SMB30SM	
Q60 page 88		SMBAMSQ60IP page 739	SMBAMSQ60P page 739	SMBQ60 page 739	SMBQ60IP			
MINI-BEAM page 76		SMB18A page 732	SMB18FA.. page 733	SMB18Q page 733	SMB18SF page 733	SMB18UR page 733	SMB3018SC page 733	SMB30SK page 733
		SMB30SUS page 734	SMB312B page 734	SMB312PD page 734	SMB312S page 734	SMB46L page 734	SMB46S page 734	SMB46U page 735
		SMBAMS18P page 735	SMBAMS18RA page 735	SMH241F page 736	SMB18FM page 733	SMB18S	SMB18C	SMBQS18VLP6LPQ
Q25 page 78		SMB18A page 732	SMB18FA.. page 733	SMB18Q page 733	SMB18SF page 733	SMB18UR page 733	SMB3018SC page 733	SMB30SK page 733
		SMB312PD page 734						
Q40 page 80		SMB30A page 737	SMB30FA.. page 737	SMB30MM page 737	SMB30Q page 737	SMB30RAVK page 737	SMB30SC page 738	SMBAMS30P page 738
		SMBAMS30RA page 738	SMB30C	SMB30FVK	SMB30S	SMB30SM		















Banner Bracket Selection Chart

**SENSORS**

Pico Dot page 92		SMB46A page 867	SMB46L page 868	SMB46S page 868	SMB46U page 868			
QM42/QMT42 page 94		SMB3018SC page 866	SMB30SK page 866	SMB30SUS page 866	SMB42F page 875	SMB42L page 875	SMB42T page 875	SMB42U page 875
		SMB46L page 868	SMB46S page 868	SMB46U page 868	SMH241F page 870			
T8 page 100		SMB8MM page 827	SMBF page 827					
T18/T18U page 102		SMB1815SF page 870	SMB18A page 732	SMB18AFA.. page 864	SMB18FA.. page 733	SMB18FM page 733	SMB18Q page 733	SMB18SF page 733
		SMB18UR page 733	SMB3018SC page 866	SMB30SK page 866	SMBC18 page 888	SMBAMS18P page 868	SMBAMS18RA page 868	SMBT18Y page 870
		SMB18S	SMB18C	SMB312P	SMBQS18VP6LPQ			
TM18 page 106		SMB18A page 732	SMB18AFA.. page 864	SMB18FA.. page 733	SMB18FM page 733	SMB18Q page 733	SMB18SF page 733	SMB18UR page 733
		SMB3018SC page 866	SMB30SK page 866	SMB312PD page 867	SMBAMS18P page 868	SMBAMS18RA page 868	SMBT18Y page 870	SMBC18 page 888
		SMB18C	SMB18A page 732	SMBQS18VP6LPQ				
T30/T30U page 110		SMB1815SF page 870	SMB30A page 872	SMB30FA.. page 872	SMB30MM page 872	SMB30Q page 872	SMB30RAVK page 873	SMB30SC page 873
		SMBAMS30P page 873	SMBAMS30RA page 873	SMB30C	SMB30S	SMB30SM	SMBFVK	
M12 page 116		SMB12FA.. page 863	SMB12MM page 864	SMBQS12PD page 864	SMB1812SF page 865			
S12-2 page 122		SMB12FA.. page 863	SMB12MM page 864	SMBQS12PD page 864	SMB1812SF page 865			
SB12/SB12T page 120		SMB12MM page 864	SMBQS12PD page 864	SMB1812SF page 865				
S18/S18-2/S18U page 122		SMB18A page 732	SMB18FA.. page 733	SMB18FM page 733	SMB18Q page 733	SMB18SF page 733	SMB18UR page 733	SMB3018SC page 866
		SMB30SK page 866	SMB312PD page 867	SMB46A page 867	SMBAMS18P page 868	SMBC18 page 888	SMBQS18VP6LPQ	SMB18C
		SMB18S						
M18 page 126		SMB18A page 732	SMB18FA.. page 733	SMB18FM page 733	SMB18Q page 733	SMB18SF page 733	SMB18UR page 733	SMB3018SC page 866
		SMB30SK page 866	SMB312PD page 867	SMB46A page 867	SMBAMS18P page 868	SMBC18 page 888	SMBQS18VP6LPQ	SMB18C
		SMB18S						













## Banner Bracket Selection Chart

## SENSORS

S30/SM30 page 140		SMB30A page 737	SMB30FA.. page 737	SMB30MM page 737	SMB30Q page 737	SMB30RAVK page 737	SMB30SC page 738	SMBAMS30P page 738
		SMBAMS30RA page 738	SMB30C	SMB30S	SMB30SM	SMB30FVK		
SL10 & SL30 page 147		SMBSL page 740						
LX page 148		SMBLX page 740	SMBLXR page 740					
VS1 page 156		SMBVS1S page 730	SMBVS1SC page 730	SMBVS1T page 731	SMBVS1TC page 731			
VS2 page 158		SMBVS2RA page 731						
VS3 page 160		SMBVS3S page 731	SMBVS3T page 731					
DF-G page 162		DIN-35.. page 730	SA-DIN.. page 730	SMBR55F01 page 730	SMBR55F02	SMBR55RA		
D10 page 172		DIN-35.. page 730	SMBR55F01 page 730	SMBR55FRA page 730	SA-DIN.. page 730	SMBR55F02		
R55F page 294		DIN-35.. page 730	SMBR55F01 page 730	SMBR55FRA page 730	SMBR55F02			
LTF page 204		SMBLTFL	SMBLTFU	SMBAMSSLTFP				
LE page 206		SMBLEU	SMBLEL	SMBLEFA				
LH page 208		SMBLH1 page 740	SMBLH.. page 740					
LT3 page 212		SMBLT3IP page 741	SMBLT32 page 741	SMBLT31 page 740	SMBAMSLT3IP	SMBAMSLT3P		
LT7 page 214		SMBLT7 page 741	SMBLT7F page 741					











Banner Bracket Selection Chart

**SENSORS**

QT50U page 238 	SMB30A page 737	SMB30FA.. page 737	SMB30MM page 737	SMB30RAVK page 737	SMB30SC page 738	SMBAMS30P page 738	SMBAMS30RA page 738
	SMB30C	SMB30S	SMB30FVK	SMB30SM			
M25U page 226 	SMBM25A page 741	SMBM25B page 741					
QT50R page 244 	SMB30A page 737	SMB30FA.. page 737	SMB30MM page 737	SMB30SC page 738	SMBAMS30P page 738	SMBAMS30RA page 738	
	SMB30C	SMB30S	SMB30FVK	SMB30SM			
EZ-ARRAY page 248 	EZA-MBK-11 page 750	EZA-MBK-12 page 750	EZA-MBK-20 page 750	SMBLBCZB page 741			
MINI-ARRAY page 252 	MSMB-3 page 741						
R58 page 290 	SMB55A page 742	SMB55F page 742	SMB55RA page 742	SMB55S page 742			
QC50 page 284 	SMBQC50 page 742						
QL56 page 288 	SMB55A page 742	SMB55F page 742	SMB55RA page 742	SMB55S page 742			
QM26 page 298 	SMBLSTDLQ26 page 737	SMBLSTQ26 page 737					
QMH26 page 300 	SMBQMH26-SS-150 page 737						
Q26 page 318 	SMBLSTDLQ26 page 737	SMBLSTQ26 page 737					
M18-T page 262 	SMB18A page 732	SMB18FA.. page 732	SMB18FM page 733	SMB18Q page 733	SMB18SF page 733	SMB18UR page 733	SMB3018SC page 733
	SMB30SK page 733	SMB312PD page 734	SMB46A page 734	SMBAMS18P page 735	SMBC18 page 747	SMBQS18VP6LPQ	SMB18C

Banner Bracket Selection Chart









VISION

iVu page 342		SMBIVUB page xxx	SMBIVURAL page xxx	SMBIVURAR page xxx	SMBIVUU page xxx			
PresencePLUS® PRO page 358		SMBPPDE page xxx	SMBPPDH page xxx	SMBPPLU page xxx	SMBPPRA page xxx	SMBPPROMRA page xxx	SMBPPSU page xxx	SMBPPU page xxx
PresencePLUS® P4 page 354		SMBP4RAB page xxx	SMBP4RAS page xxx	SMBP4SRAF page xxx				
Ring Lights page 366		SMBPMPRHI page xxx	SMBPPRHI page xxx					
Area Lights page 378		SMBABM page xxx	SMBACM page xxx	SMBAMS70A page xxx	SMBAMS70AS page xxx	SMBASC page xx	SMBP42ASM page xxx	SMBP4ASM page xx
		SMBAMS30PL52	SMBVLA62X62RA page xxx					
Backlights page 370		SMBABM page xxx	SMBACM page xxx	SMBBSSM page xxx				
Linear Array Backlights page 371		SMBLAXRA page xxx	SMBLAXU page xxx					
Linear Array page 372		SMBLASRA page xxx	SMBLAXRA page xxx	SMBLAXU page xxx				
On-Axis Lights page 373		SMBP40AL100 page xxx	SMBP40AL50 page xxx	SMBPPOAL100 page xxx	SMBPPOAL50 page xxx			
Spot Lights page 374		SMBP42ASM page xxx	SMBPPLK					
Spot Lights page 375		SMB30A page xxx	SMB30FA.. page xxx	SMB30SC page xxx	SMBAMS30P page xxx	SMBAMS30RA page xxx		



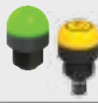

Banner Bracket Selection Chart

LIGHTING & INDICATORS

WLA page 402		SMBBSSM page 885	SMBBSRA page 885					
WL50S page 404		SMB30A page 872	SMB30SC page 873	SMB30FA.. page 872	SMBAMS30RA page 873	SMB30MM page 872	SMBAMS30P page 873	
WL50-2 page 406		SMB30A page 872	SMB30SC page 873	SMB30MM page 872				
Tower Lights page 412		SMB30A page 872	SMB30FA.. page 872	SMB30MM page 872	SMB30RAVK page 873	SMB30SC page 873	SMBAMS30P page 873	SMBAMS30RA page 873
		SMBAMS30RLJ page 887	SMB30Q page 872	SMBAMS30RLS page 888	SMBAMS30R52	SMBAMS30RL52R	SMB30FVK	SMB30C
		SMB30S	SMB30SM					
K50 Housing page 434		SMB30A page 872	SMB30FA.. page 872	SMB30MM page 872	SMB30RAVK page 873	SMB30SC page 873	SMBAMS30P page 873	SMB30Q page 872
		SMBAMS30PL52R	SMBAMS30PL52	SMBAMS30RA page 873	SMBAMS30RLJ page 887	SMBAMS30RLS page 888	SMB30C	SA-K50A18 page 888
		SMBARP...30 page 888	SMBAMS30P page 873	SMB30FVK	SMB30S	SMB30SM		
K30 Housing page 434		SMB22A	SMBAMS22RA	SMBAMS22P	SMB22FVK	SMB30RAVK		
S18L page 450		SMB18A page 732	SMB18FA.. page 864	SMB18FM page 865	SMB18Q page 865	SMB18SF page 865	SMB18UR page 865	SMB3018SC page 866
		SMB30SK page 866	SMB312PD page 867	SMB46A page 867	SMBAMS18P page 868	SMB18C page 888	SMBQS18VP6LPQ	SMB18C
		SMB18S						
S22L page 451		SMB22A	SMB22FVK	SMB22RAVK	SMBAMS22P	SMBAMS22RA		
T8L page 454		SMB8MM page 863	SMBF page 860					
K80 Housing page 458		SMBDX80DIN page 860	SMBAMS80PL52R	SMBAMS80PL52				



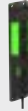









Banner Bracket Selection Chart

**LIGHTING & INDICATORS**

 <p>OTB/LTB/VTB page 478</p>	SMB30A page 872	SMB30FA.. page 872	SMB30MM page 872	SMB30Q page 872	SMB30RAVK page 873	SMB30SC page 873	SMBAMS30P page 873
	SMBAMS30RA page 873	SMBAMS30RLJ page 887	SMBAMS30RLS page 888	SMBAMS30PL52	SMBAMS30PL52R	K50-SA-K50	SMB30C
	SMB30S	SMB30SM	SMBFVR				
 <p>PVD page page 496</p>	SMBPVA1 page 888	SMBPVA11 page 889	SMBPVA2 page 889	SMBPVA..C page 889	SMBPVA6 page 890	SMBPVA7 page 890	SMBPVA8 page 890
	SMBPVA9 page 890	SMBPVA..A page 889	SMBPVA..AB page 889				
 <p>PVL page 498</p>	SMBPVL1 page 890	SMBPVL2 page 889	SMBPVL3 page 891	SMBPVL4 page 891	SMBPVL5 page 891		
 <p>PVA page 522</p>	SMBPVA1 page 888	SMBPVA2 page 889	SMBPVA.. page 889	SMBPVA..A page 889	SMBPVA..AB page 889	SMBPVA..C page 889	SMBPVA6 page 890
	SMBPVA7 page 890	SMBPVA8 page 890	SMBPVA9 page 890				

Banner Bracket Selection Chart

**SAFETY**

EZ-SCREEN® 14 & 30 mm Resolution page 556 	EZA-MBK-11 page 892	EZA-MBK-12 page 892	EZA-MBK-21 page 893				
EZ-SCREEN® LP 14 & 25 m Resolution page 564 	LPA-MBK-11 page 894	LPA-MBK-12 page 894	LPA-MBK-20 page 894	LPA-MBK-135 page 894	LPA-MBK-180 page 895	LPA-MBK-PXXX page 896	LPA-MBK-21 page 894
EZ-SCREEN® Grid page 572 	EZA-MBK-1 page 892	EZA-MBK-2 page 892	EZA-MBK-3 page 893	EZA-MBK-9 page 894			
EZ-SCREEN® Point page 573 	EZA-MBK-1 page 892	EZA-MBK-2 page 892	EZA-MBK-3 page 893	EZA-MBK-4 page 893	EZA-MBK-5 page 893	EZA-MBK-9 page 894	
EZ-SCREEN® Type 2 30 mm Resolution page 578 	USCMB-.. page 897		USMB-1 page 897	USMB-6 page 898	USMB-8 page 898		
AG4 page 693 	AG4-MBK1 page 896						
XS26-2 page 588 	DIN-35-.. page 860						
SC22-3 page 592 	DIN-35-.. page 860						
Safety Modules page xxx 	DIN-35-.. page 860						
DUO-TOUCH® SG Run Bars page xxx 	STBA-RB1-MB1 page 897	STBA-RB1-MB2 page 897	STBA-RB1-MB3 page 897	STBA-RB2-MB1 page 897	STBA-RB2-MB2 page 897	STBA-RB2-MB3 page 897	
30 mm Mount E-Stops page xxx 	SSA-MBK-EEC1 page 896	SSA-MBK-EEC2 page 896	SSA-MBK-EEC3 page 896				
ED1G Enabling Devices page 636 	ED9Z-GH1 page 898						

**DIN-35...** (All measurements in mm)

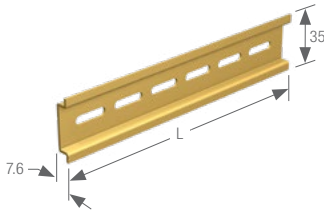

Hole center spacing: 35.1  
Hole size: 25.4 x 5.3

Model	Length (L)
DIN-35-70	70
DIN-35-105	105
DIN-35-140	140

- Available in 70, 105 & 140 mm lengths

Used with:

DF-G1	R55F	SC22-3 Controllers
D10	MINI-ARRAY Controller	Two-Hand Control Modules
D12	High-Res MINI-ARRAY Controller	Safety Modules

**SMBDX80DIN** (All measurements in mm)

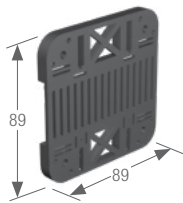

- Black reinforced thermoplastic
- Bracket for mounting on 35 mm DIN rail

Used with:

K80	EZ-LIGHT SP150	DX81
EZ-LIGHT K80L	DX80	DX91
EZ-LIGHT K80CLR	DX85	DX90

**SA-DIN-BRACKET\*** (All measurements in mm)

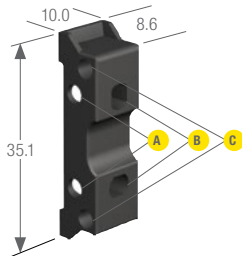

Hole center spacing:  
A = 16, B = 25.4, C = 15.2  
Hole size:  
A =  $\varnothing$  3.2, B =  $\varnothing$  3.3, C =  $\varnothing$  4.4

- Plastic bracket with mounting screws

\* SA-DIN-BRACKET-10  
(Kit of 10 brackets and mounting screws)

Used with:

DF-G1  
D10

**SMBF** (All measurements in mm)

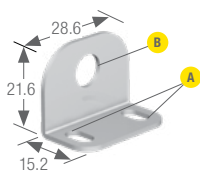

Hole center spacing:  
A = 19.1  
Hole size:  
A = 8 x 4.6, B =  $\varnothing$  8.3

- Right-angle bracket for glass fiber optic with 5/16" 24 threaded tip
- 18-ga. stainless steel

Used with:

Glass fiber with 5/16" - 24 threaded tip

**SMBR55F01** (All measurements in mm)

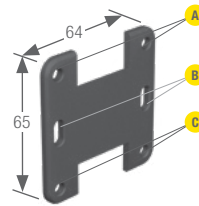

Hole center spacing:  
A, B, C = 50.8, A to B, B to C = 25.3

Hole size:  
A, C =  $\varnothing$  5.6, B = 11 x 5

- Flat-mounting bracket
- Eliminates need for DIN rail
- Molded PBT polyester
- Black reinforced thermoplastic polyester

Used with:

R55F	D10
DF-G1	D12

**SMBR55FRA** (All measurements in mm)

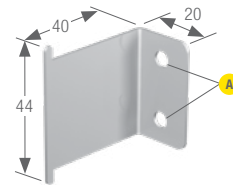

Hole center spacing:  
A = 20

Hole size  
A =  $\varnothing$  5.4

- Side-mounting bracket
- Eliminates need for DIN rail
- 19-ga. stainless steel

Used with:

R55F	D10
DF-G1	D12

**SMBVS1S** (All measurements in mm)

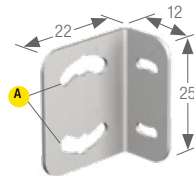

Hole center spacing:  
A = 16.8

Hole size:  
A = 3.5 x 12.3

- Short right-angle bracket
- 18-ga. stainless steel

Used with:

VS1

**SMBVS1SC** (All measurements in mm)

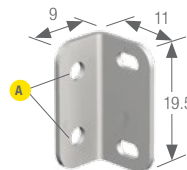

Hole center spacing:  
A = 10.0

Hole size:  
A =  $\varnothing$  2.8

- Short right-angle bracket
- 18-ga. stainless steel

Used with:

VS1

**SMBVS1T** (All measurements in mm)

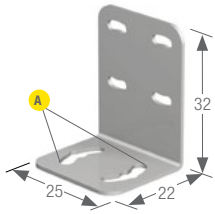

Hole center spacing:

**A** = 16.8

Hole size:

**A** = 3.5 x 12.3

- Tall right-angle bracket
- Stainless steel

Used with:  
VS1

**SMBVS3T** (All measurements in mm)

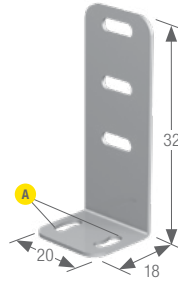

Hole center spacing:

**A** = 13.5

Hole size:

**A** = 3.2 x 7.7

- Tall right-angle bracket
- 300 stainless steel

Used with:  
VS3

**SMBVS1TC** (All measurements in mm)

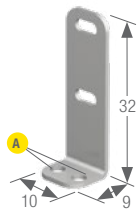

Hole center spacing:

**A** = 5.5

Hole size:

**A** =  $\varnothing$  2.8

- Tall right-angle compact bracket
- 300 stainless steel

Used with:  
VS1

**SMBFP3** (All measurements in mm)

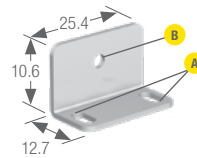

Hole center spacing:

**A** = 19.1

Hole size:

**A** = 6.5 x 3.6, **B** =  $\varnothing$  3.2

- Right-angle bracket for glass fiber optic with 3 mm threaded tip
- 18-ga. stainless steel

Used with:  
Plastic fiber with M3 tip

**SMBVS2RA** (All measurements in mm)

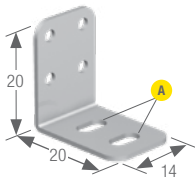

Hole center spacing:

**A** = 80

Hole size:

**A** = 3.2 x 6

- Right-angle bracket
- Stainless steel

Used with:  
VS2

**SMBFP4N** (All measurements in mm)

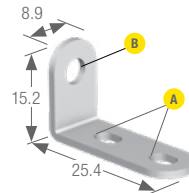

Hole center spacing:

**A** = 12

Hole size:

**A** = 4.8 x 5, **B** =  $\varnothing$  4.2

- Low-profile right-angle bracket for plastic fiber optics with 4 mm threaded tip
- 18-ga. stainless steel

Used with:  
Plastic fiber with M4 tip

**SMBVS3S** (All measurements in mm)

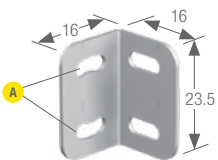

Hole center spacing:

**A** = 13.5

Hole size:

**A** = 3.2 x 7.7

- Right-angle bracket
- 300 stainless steel

Used with:  
VS3

**SMBFP6** (All measurements in mm)

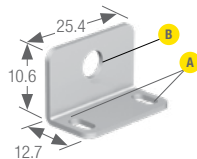

Hole center spacing:

**A** = 19.1

Hole size:

**A** = 6.5 x 3.6, **B** =  $\varnothing$  6.2

- Right-angle bracket for plastic fiber optics with 6 mm threaded tip
- 18-ga. stainless steel

Used with:  
Plastic fiber with M6 tip

**SMB8MM** (All measurements in mm)

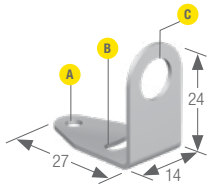

Hole center spacing:  
**A** to **B** = 14  
 Hole size:  
**A** =  $\varnothing$  3.5, **B** = 8.3 x 3.5, **C** =  $\varnothing$  8.4

- Right-angle bracket
- 300 series stainless steel

Used with:  
 T8  
 EZ-LIGHT T8L2  
 Glass fiber with 5/116" - 24 threaded tip

**SMBQ12A** (All measurements in mm)

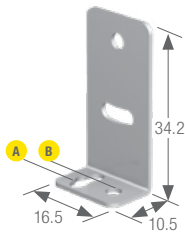

Hole center spacing:  
**A** to **B** = 7.6  
 Hole size:  
**A** = 3.5 x 8.1, **B** =  $\varnothing$  3.2

- Adjustable right-angle bracket
- 20-ga. 300 series stainless steel

Used with:  
 Q12

**SMBQ12T** (All measurements in mm)

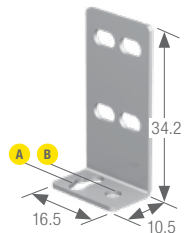

Hole center spacing:  
**A** to **B** = 7.6  
 Hole size:  
**A** = 3.5 x 8.1, **B** =  $\varnothing$  3.2

- Right-angle bracket
- 20-ga. 300 series stainless steel

Used with:  
 Q12

**SMB12FA..** (All measurements in mm)

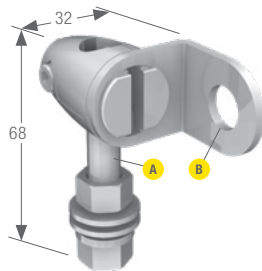

Hole size:  
**B** =  $\varnothing$  12.1

Model	Bolt Thread (A)
SMB12FA	3/8 - 16 x 2"
SMB12FAM10	M10 - 1.5 x 50

- Swivel bracket with tilt and pan movement for precision adjustment
- Easy sensor mounting to extruded rail T-slots
- Metric and inch size bolts available
- 12 mm sensor mounting hole

Used with:  
 M12  
 S12

**SMB12MM** (All measurements in mm)

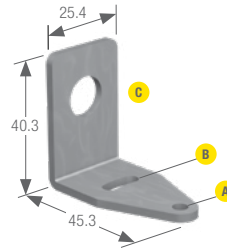

Hole center spacing:  
**A** to **B** = 26  
 Hole size:  
**A** =  $\varnothing$  4.6, **B** = 12.8 x 4.6, **C** =  $\varnothing$  12.3

- $\pm 10^\circ$  of lateral movement
- 12-ga. stainless steel
- Mounting holes for M4 (#6) hardware
- 12 mm sensor mounting hole

Used with:  
 M12  
 S12

**SMBQS12PD** (All measurements in mm)

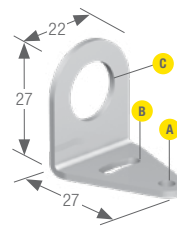

Hole center spacing:  
**A** to **B** = 14  
 Hole size:  
**A** =  $\varnothing$  3.5, **B** = 3.5 x 10.6, **C** =  $\varnothing$  13

- Right-angle, nose-mount bracket
- 16-ga. 300 series stainless steel

Used with:  
 M12  
 S12

**SMB18A** (All measurements in mm)

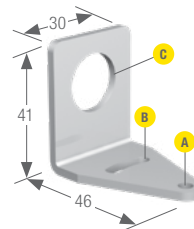

Hole center spacing:  
**A** to **B** = 24.2  
 Hole size:  
**A** =  $\varnothing$  4.6, **B** = 17 x 4.6, **C** =  $\varnothing$  18.5

- Right-angle mounting bracket with a curved slot for versatile orientation
- 12-ga. stainless steel, 18 mm sensor mounting hole
- Clearance for M4 (#8) hardware

Used with: M18    TM18    T18U    MINI-BEAM    EZ-LIGHT T18  
 QS18    S18    S18U    Q25    Q45UR M18C2    EZ-LIGHT M18  
           T18    QS18U    Q45UR S18C2

**SMB18ATFA..** (All measurements in mm)

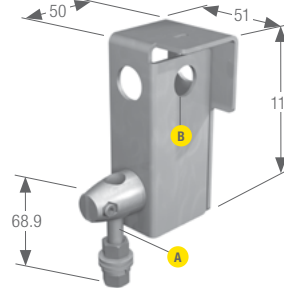

Hole size:  
**B** =  $\varnothing$  18.1

Model	Bolt Thread (A)
SMB18ATFA	3/8 - 16 x 2"
SMB18ATFAM10	M10 - 1.5 x 50

- Protective, swivel bracket with tilt and pan movement for precision adjustment
- Easy sensor mounting to extruded rail T-slots
- Metric and inch size bolts available
- Mounting hole for 18 mm sensors

Used with:  
 TM18  
 T18

QS18 (AC/DC models)

**SMB18FA..** (All measurements in mm)

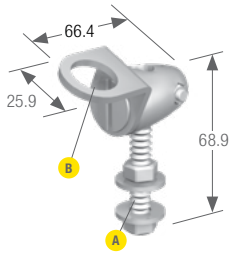

Hole size:

**B** =  $\varnothing$  18

Model Bolt Thread (A)

SMB18FA	3/8 - 16 x 2"
SMB18FAM10	M10 - 1.5 x 50

- Swivel bracket with tilt and pan movement for precision adjustment
- Easy sensor mounting to extruded rail T-slots
- Metric and inch size bolts available
- 18 mm sensor mounting hole

Used with:	TM18	MINI-BEAM	Q45UR S18C2
QS18	QS18U	S18/M18/T18	EZ-LIGHT M18
S18U	T18U	Q45UR M18C2	EZ-LIGHT T18

**SMB18SF** (All measurements in mm)

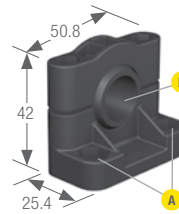

Hole center spacing:

**A** = 36

Hole size:

**A** =  $\varnothing$  5.3, **B** =  $\varnothing$  18

- 18 mm swivel bracket with M18 x 1 internal thread
- Black thermoplastic polyester
- Stainless steel swivel locking hardware included

Used with:	S18	Q25	EZ-LIGHT T18	Q45UR S18C2
QS18	M18	S18U	EZ-LIGHT M18	Q45UR M18C2
T18	T18U	Q45UR M18C2	MINI-BEAM	

**SMB18FM** (All measurements in mm)

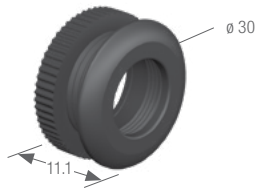

Hole center spacing:

Hole size:

- Two-piece thermoplastic through-mount bracket
- Mounting nut (M22 x 1.5) and outer flange (M22 x 1.5 external, M18 x 1 internal)

Used with:	S18	S18-2
QS18	T18	S18U
M18	TM18	QS18U

**SMB18UR** (All measurements in mm)

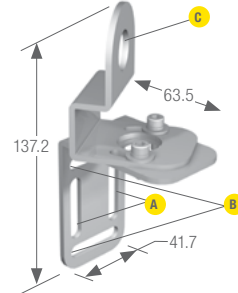

Hole center spacing:

**A** = 25.4, **B** = 46.7

Hole size:

**A**, **B** = 6.9 x 32, **C** =  $\varnothing$  18.3

- 2-piece universal swivel bracket
- 300 series stainless steel
- Stainless steel swivel locking hardware included
- Mounting hole for 18 mm sensor

Used with:	T18	T18U	Q45UR S18C2	Q45UR M18C2
QS18*	TM18	Q25		
S18	S18U	EZ-LIGHT T18		
M18	QS18U*	EZ-LIGHT M18		

\* Contact factory to verify compatibility with integral OD models.

**SMB18Q** (All measurements in mm)

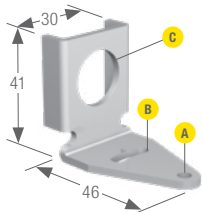

Hole center spacing:

**A** to **B** = 24.2

Hole size:

**A** =  $\varnothing$  4.6, **B** = 17 x 4.6, **C** =  $\varnothing$  19

- Right-angle flanged bracket
- 18 mm sensor mounting hole
- 12-ga. stainless steel

Used with:	S18	S18U	QS18U	MINI-BEAM	Q45UR M18C2
QS18	M18	TM18		Q45UR S18C2	EZ-LIGHT T18
T18	T18U			Q45UR M18C2	EZ-LIGHT M18

**SMB3018SC** (All measurements in mm)

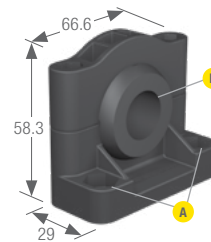

Hole center spacing:

**A** = 50.8

Hole size:

**A** =  $\varnothing$  7, **B** =  $\varnothing$  18

- 18 mm swivel side or barrel-mount bracket
- Black reinforced thermoplastic polyester
- Stainless steel swivel locking hardware included

Used with:	T18U	Q25	M18/S18/T18	EZ-LIGHT T18
QS18	S18U	S18/M18/T18	Q45UR S18C2	MINI-BEAM
	QS18U		Q45UR M18C2	QM42/QMT42

**SMB1812SF** (All measurements in mm)

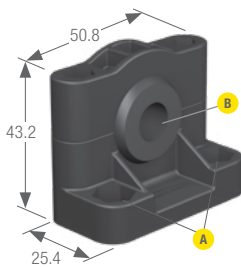

Hole center spacing:

**A** = 36.1

Hole size:

**A** =  $\varnothing$  5, **B** =  $\varnothing$  12

- Swivel bracket with 12 mm mounting hole
- Black reinforced thermoplastic polyester
- Stainless steel mounting and swivel locking hardware included

Used with:	M12	S12
------------	-----	-----

**SMB30SK** (All measurements in mm)

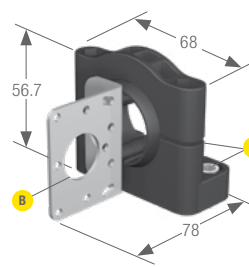

Hole center spacing:

**A** = 50.8

Hole size:

**A** =  $\varnothing$  7, **B** =  $\varnothing$  18

- Flat-mount swivel bracket with extended range of motion
- Black reinforced thermoplastic polyester and 316 stainless steel
- Stainless steel swivel locking hardware included

Used with:	T18U	Q25	QM42/QMT42	EZ-LIGHT T18
QS18	S18U	MINI-BEAM	S18/M18/T18	EZ-LIGHT M18
	QS18U		Q45UR S18C2	Q45UR M18C2

# ACCESSORIES

# BRACKETS

# CORDSETS

# RETROREFLECTORS

## SMB30SUS (All measurements in mm)

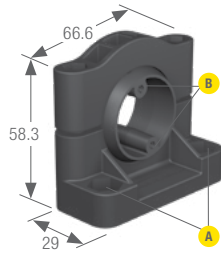

Hole center spacing:  
**A** = 50.8, **B** = 24.1  
 Hole size:  
**A** =  $\varnothing$  7, **B** =  $\varnothing$  7.6

- Side-mount swivel bracket with extended range of motion
- Black reinforced thermoplastic polyester
- Stainless steel swivel locking hardware included

Used with:  
 QS18

MINI-BEAM  
 QM42/QMT42  
 QS18U

## SMB312B (All measurements in mm)

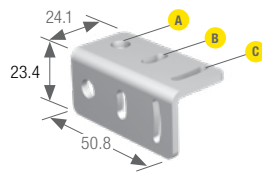

Hole center spacing:  
**A** to **B** = 17.3, **B** to **C** = 17.7, **A** to **C** = 35  
 Hole size:  
**A** =  $\varnothing$  6.9, **B** = 4.3 x 10.5, **C** = 3.1 x 15.2

- Right-angle
- Stainless steel base mounting bracket
- Includes mounting foot

Used with:  
 MINI-BEAM

## SMB312PD (All measurements in mm)

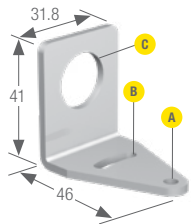

Hole center spacing:  
**A** = 20.3, **B** to **C** = 5.1  
 Hole size:  
**A** = 4.3 x 7.5, **B** =  $\varnothing$  3, **C** = 3 x 15.3

- Right-angle mounting bracket with a curved slot for versatile orientation
  - 12-ga. stainless steel, 18 mm sensor mounting hole
  - Clearance for M4 (#8) hardware
- NOTE: Not for use with plastic fiber optic sensors

Used with: S18 TM18 T18U EZ-LIGHT T18 Q45UR  
 QS18 M18 S18U Q25 EZ-LIGHT M18 S18C2  
 T18 QS18U MINI-BEAM Q45UR M18C2

## SMB312S (All measurements in mm)

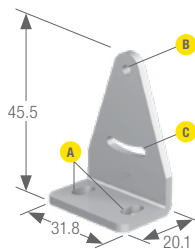

Hole center spacing:  
**A** = 20.3, **B** to **C** = 5.1  
 Hole size:  
**A** = 4.3 x 7.5, **B** =  $\varnothing$  3, **C** = 3 x 15.3

- Stainless steel 2-axis side-mounting bracket

Used with:  
 QS18

MINI-BEAM  
 QS18U

## SMB4050YL (All measurements in mm)

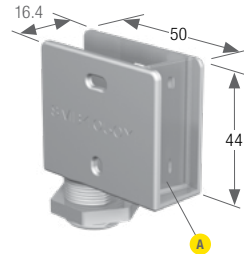

Hole center spacing:

Hole size:  
**A** =  $\varnothing$  15.3

- Heavy-duty die-cast bracket for industrial protection
- Replaceable window for use with some sensor models
- M18 vertical mounting option
- Nut and lock washer included

Used with:  
 QS18 DC Models (except AF)

## SMB46A (All measurements in mm)

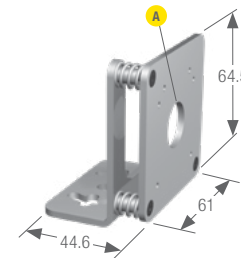

Hole center spacing:

Hole size:  
**A** =  $\varnothing$  18.3

- Stainless steel
- Adjustable mounting

Used with:  
 QS18  
 S18  
 PICODOT

## SMB46L (All measurements in mm)

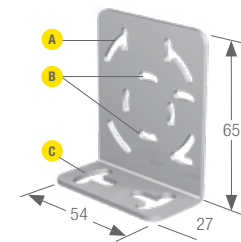

Hole center spacing:

**A** = 45.42  
**B** = 24.1  
 Hole size:  
**A** = 3X  $\varnothing$  3.5  
**B** = 8X  $\varnothing$  3.5  
**C** =  $\varnothing$  6.5

- 14-ga. 316 stainless steel

Used with:  
 QS18  
 S18  
 QS30

QM42/QM42T  
 MINI-BEAM  
 PICODOT

## SMB46S (All measurements in mm)

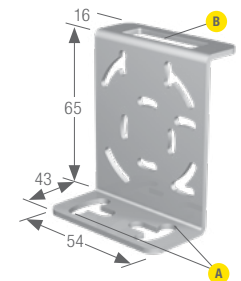

Hole center spacing:

**A** = 16  
 Hole size:  
**A** = 16.5 x 18.7,  
**B** = 34 x 10

- Right-angle
- S bracket
- 14-ga. 316 stainless steel

Used with:  
 QS18  
 MINI-BEAM  
 QS30

PicoDot  
 QM42/QMT42  
 QS18U



**SMB46U** (All measurements in mm)

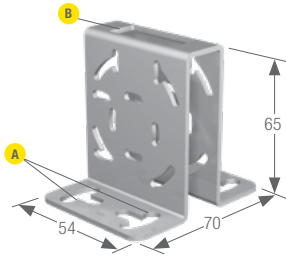

Hole center spacing:  
**A** = 16  
 Hole size:  
**A** = 16.5 x 18.7, **B** = 34 x 13

- Right-angle
- U bracket for sensor protection
- 14-ga. 316 stainless steel

Used with:  
 QS18  
 MINI-BEAM

PicoDot  
 QM42/QMT42  
 QS18U

**SMBQS18AF** (All measurements in mm)

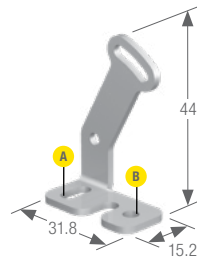

Hole center spacing:  
**A** to **B** = 20.3  
 Hole size:  
**A** = 4.3 x 9.4, **B** =  $\varnothing$  4.3

- Right-angle mounting bracket
- 14-ga. 304 stainless steel

Used with:  
 QS18AF (Only)

**SMBAMS18P** (All measurements in mm)

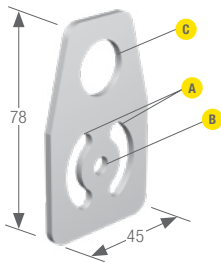

Hole center spacing:  
**A** = 26, **A** to **B** = 13  
 Hole size:  
**A** = 26.8 x 7, **B** =  $\varnothing$  6.5, **C** =  $\varnothing$  19

- Flat SMBAMS series bracket with 18 mm hole for mounting sensors
- Articulation slots for 90+° rotation
- 12-ga. (2.6 mm) cold-rolled steel

Used with:  
 QS18  
 S18  
 M18

T18  
 TM18  
 S18U  
 T18U

Q45UR S18C2  
 Q45UR M18C2  
 QS18U

EZ-LIGHT T18  
 EZ-LIGHT M18

**SMBQS18DIN** (All measurements in mm)

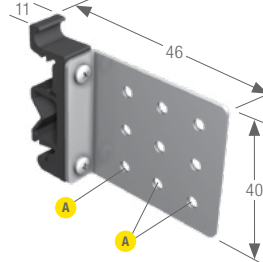

Hole center spacing:  
**A** = 12.1  
 Hole size:  
**A** = 9x  $\varnothing$  3.5

- Right-angle bracket assembly for mounting on 35 mm DIN rail
- 300 series stainless steel and glass filled nylon; zinc-plated screws

Used with:  
 QS18 (shown with DIN-35..)

**SMBAMS18RA** (All measurements in mm)

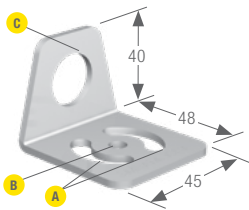

Hole center spacing:  
**A** = 26, **A** to **B** = 13  
 Hole size:  
**A** = 26.8 x 7, **B** =  $\varnothing$  6.5, **C** =  $\varnothing$  19

- Right-angle SMBAMS series bracket with 18 mm hole for mounting sensors
- Articulation slots for 90+° rotation
- 12-ga. (2.6 mm) cold-rolled steel

Used with:  
 QS18  
 S18  
 M18

T18  
 TM18  
 S18U  
 T18U

MINI-BEAM  
 Q45UR S18C2  
 Q45UR M18C2

EZ-LIGHT T18  
 EZ-LIGHT M18  
 QS18U

**SMBQS18RA** (All measurements in mm)

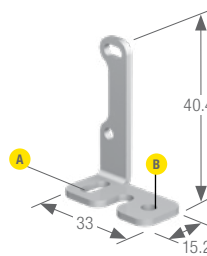

Hole center spacing:  
**A** to **B** = 20.3  
 Hole size:  
**A** = 4.3 x 9.4, **B** =  $\varnothing$  4.3

- Right-angle mounting bracket
- 14-ga. 304 stainless steel

Used with:  
 QS18 (except QS18AF)  
 QS18U

**SMBQS18A** (All measurements in mm)

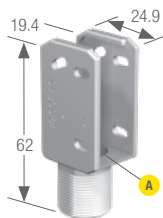

Hole size:  
**A** =  $\varnothing$  15.3

- Wrap-around protection bracket
- Base fits 18 mm threaded hole
- Metal hex nut, lock washer and grommet included
- Mounting holes specially designed for QS18AF sensors

Used with:  
 QS18 (DC only)  
 QS18U

QS18AF

**SMBQS18Y** (All measurements in mm)

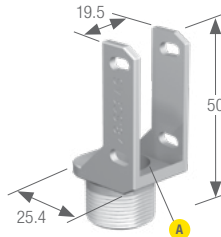

Hole size:  
**A** =  $\varnothing$  15.3

- Die-cast bracket for 18 mm holes
- Includes metal hex nut and lock washer
- Allows  $\pm$  8° for cabled sensors

Used with:  
 QS18 (DC only)  
 QS18U

**SMBQS18YL** (All measurements in mm)

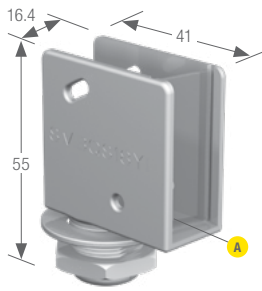

Hole size:  
**A** =  $\varnothing$  15.3

- Heavy-duty die-cast bracket for industrial protection
- Replaceable window
- M18 vertical mount-option
- Nut and lock washer included

Used with:  
 QS18AF  
 (Class 2 Laser Only)

**SMH241F** (All measurements in mm)

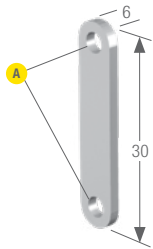

Hole center spacing:  
**A** = 24

Hole size:  
**A** =  $\varnothing$  2.5

- Nut strap replaces two M3 mounting nuts and washers
- 16-ga. stainless steel

Used with:  
 QS18  
 MINI-BEAM

QM42/QMT42  
 QS18U

**SMB1815SF** (All measurements in mm)

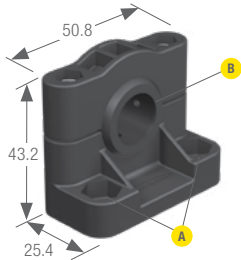

Hole center spacing:  
**A** = 36

Hole size:  
**A** =  $\varnothing$  5, **B** =  $\varnothing$  15

- Swivel with set screws for mounting sensors by the cable hub
- Black reinforced thermoplastic polyester
- Stainless steel swivel locking hardware and hex wrench included

Used with:  
 T18 T30  
 T18U T30U

EZ-LIGHT T18  
 EZ-LIGHT T30

**SMBT18Y** (All measurements in mm)

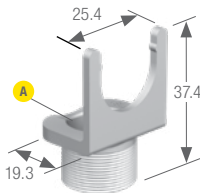

Hole size:  
**A** =  $\varnothing$  15.3

- Die-cast bracket for 18 mm holes
- Includes metal hex nut
- For use with Euro-style QD connectors and cabled versions

Used with:  
 T18  
 TM18

T18U  
 EZ-LIGHT T18

**SMBQ20H** (All measurements in mm)

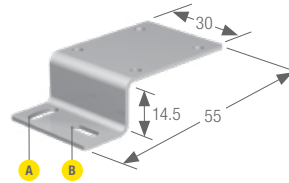

Hole center spacing:  
**A** to **B** = 20

Hole size:  
**A** = 2.8 x 9.3, **B** = 8.4 x 4.5

- Sensor horizontal flange mount
- $\pm$  10° swivel
- Stainless steel

Used with:  
 Q20

**SMBQ20L** (All measurements in mm)

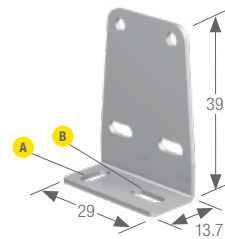

Hole center spacing:  
**A** to **B** = 20

Hole size:  
**A** = 2.8 x 9.3, **B** = 8.4 x 4.5

- Right-angle bracket
- $\pm$  5° tip,  $\pm$  5° swivel
- Stainless steel

Used with:  
 Q20

**SMBQ20LV** (All measurements in mm)

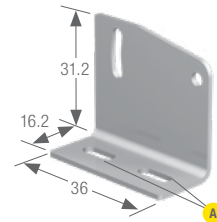

Hole center spacing:  
**A** = 12

Hole size:  
**A** = 3 x 9.4

- Right-angle bracket
- $\pm$  10° tip
- Stainless steel

Used with:  
 Q20

**SMBQ20U** (All measurements in mm)

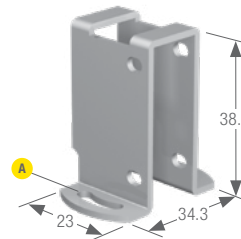

Hole center spacing:  
**A** = 26.5

Hole size:  
**A** = 3 x 12.6

- Protective bracket
- $\pm$  22.5° swivel
- Stainless steel

Used with:  
 Q20

**SMBLSTDLQ26** (All measurements in mm)

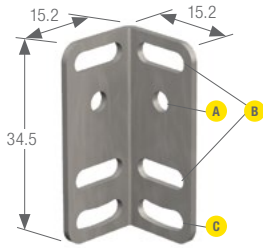

Hole center spacing:  
**B** = 10  
 Hole size:  
**A** =  $\varnothing$  3.5, **B** = 10.5 x 3.5,  
**C** = 10.5 x 3.5

- Adjustable right-angle metal bracket
- 304 stainless steel

Used with:  
 Q26  
 QM26

**SMBLSTQ26** (All measurements in mm)

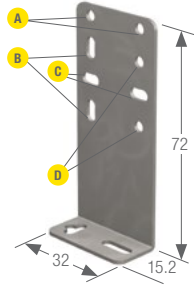

Hole center spacing:  
**A**, **B**, **C**, **D** = 20  
 Hole size:  
**A**, **D** =  $\varnothing$  3.5, **B**, **C** =  $\varnothing$  3.5

- Right-angle bracket
- 304 stainless steel

Used with:  
 Q26  
 QM26

**SMBQMH26-SS-150** (All measurements in mm)

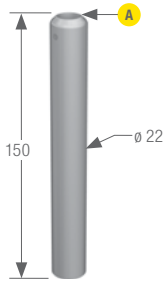

Hole size:  
**A** =  $\varnothing$  12

- Smooth surface for easy cleaning
- Setscrew adjustment of sensor
- 316L stainless steel

Used with:  
 QMH26

**SMB30A** (All measurements in mm)

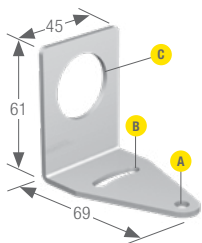

Hole center spacing:  
**A** to **B** = 40  
 Hole size:  
**A** =  $\varnothing$  6.3, **B** = 27.1 x 6.3, **C** =  $\varnothing$  30.5

- Right-angle bracket with curved slot for versatile orientation
- Clearance for M6 (1/4") hardware
- Mounting hole for 30 mm sensor
- 12-ga. stainless steel

Used with: T30U STB QT50R SM30/SMI30 EZ-LIGHT K50L  
 QS30 Q40 Q45U OTB/LTB OMNI-BEAM EZ-LIGHT TL50  
 S30 Q45 Q45UR WL50 Work Lights EZ-LIGHT CL50  
 T30 VTB QT50U EZ-LIGHT T30

**SMB30FA..** (All measurements in mm)

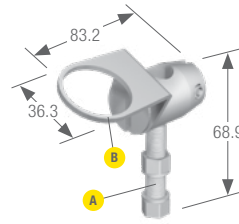

Hole size:  
**B** =  $\varnothing$  30.1

Model	Bolt Thread (A)
SMB30FA	3/8 - 16 x 2"
SMB30FAM10	M10 - 1.5 x 50

- Swivel bracket with tilt and pan movement for precision adjustment
- Mounting hole for 30 mm sensor
- Metric and inch size bolt available
- Easy sensor mounting to extruded rail T-slot

Used with: T30U Q45UR STB SM30/SMI30 EZ-LIGHT T30  
 QS30 Q40 QT50U WL50 Work Lights EZ-LIGHT K50L  
 S30 Q45 OTB/LTB SM30/SMI30 EZ-LIGHT TL50  
 T30 Q45U VTB EZ-LIGHT CL50

**SMB30MM** (All measurements in mm)

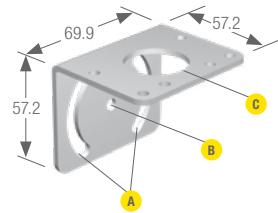

Hole center spacing:  
**A** = 51, **A** to **B** = 25.4  
 Hole size:  
**A** = 42.6 x 7, **B** =  $\varnothing$  6.4, **C** =  $\varnothing$  30.1

- 12-ga. stainless steel bracket with curved mounting slots for versatility and orientation
- Clearance for M6 (1/4") hardware
- Mounting hole for 30 mm sensor

Used with: T30U VTB Q45UR SM30/SMI30 EZ-LIGHT T30  
 QS30 Q40 STB QT50R OMNI-BEAM EZ-LIGHT K50L  
 S30 Q45 QT50U WL50 Work Lights EZ-LIGHT TL50  
 T30 OTB/LTB Q45U EZ-LIGHT CL50

**SMB30Q** (All measurements in mm)

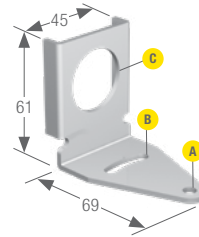

Hole center spacing:  
**A** to **B** = 40  
 Hole size:  
**A** =  $\varnothing$  6.3, **B** = 27.1 x 6.3, **C** =  $\varnothing$  30.7

- Right-angle flanged mounting bracket with curved slot for versatile orientation
- 12-ga. stainless steel
- Mounting hole for 30 mm sensor

Used with: Q40 Q45U SM30/SMI30 EZ-LIGHT T30  
 QS30 Q45 Q45UR OMNI-BEAM EZ-LIGHT K50L  
 S30 VTB OTB/LTB WL50 Work Lights  
 T30 STB

**SMB30RAVK** (All measurements in mm)

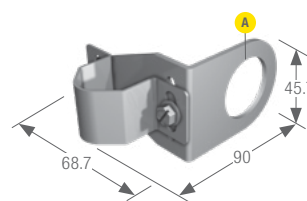

Hole size:  
**A** =  $\varnothing$  30.5

- V-clamp, right-angle bracket and fasteners for mounting sensors to pipe or extrusions
- Clamp accommodates 28 mm dia. tubing or 1" square extrusions
- 30 mm hole for mounting sensors

Used with: T30U Q45UR STB SM30/SMI30 EZ-LIGHT T30  
 QS30 Q40 QT50U K50 OMNI-BEAM EZ-LIGHT K50L  
 S30 Q45 OTB/LTB WL50 Work Lights EZ-LIGHT TL50  
 T30 Q45U VTB WL50 Work Lights

**SMB30SC** (All measurements in mm)

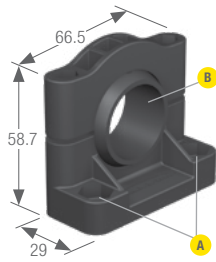

Hole center spacing:  
**A** = 50.8  
 Hole size:  
**A** =  $\varnothing$  7, **B** =  $\varnothing$  30

- Swivel bracket with 30 mm mounting hole for sensor
- Black reinforced thermoplastic polyester
- Stainless steel mounting and swivel locking hardware included

Used with:	T30U	STB	QT50R	SM30/SMI30	EZ-LIGHT T30
	QS30	Q40	QT50U	OMNI-BEAM	EZ-LIGHT K50
	S30	Q45	Q45U	WL50 Work Lights	EZ-LIGHT TL50
	T30	VTB	Q45UR		EZ-LIGHT CL50

**SMBAMS30P** (All measurements in mm)

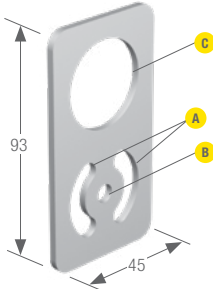

Hole center spacing:  
**A** = 26, **A** to **B** = 13  
 Hole size:  
**A** = 26.8 x 7, **B** =  $\varnothing$  6.5, **C** =  $\varnothing$  31

- Flat SMBAMS series bracket with 30 mm hole for mounting sensors
- Articulation slots for 90+° rotation
- 12-ga. (2.6 mm) cold-rolled steel

Used with:	T30U	STB	Q45UR	SM30/SMI30	EZ-LIGHT T30
	QS30	Q40	QT50R	OMNI-BEAM	EZ-LIGHT K50L
	S30	Q45	QT50U	WL50 Work Lights	EZ-LIGHT TL50
	T30	VTB	Q45U		EZ-LIGHT CL50

**SMBAMSRAB** (All measurements in mm)

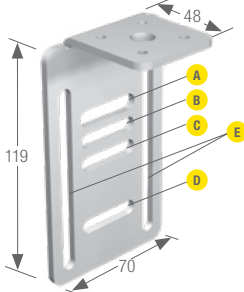

Hole center spacing:  
**A** to **B** = 12  
**B** to **C** = 11, **A** to **C** = 23,  
**A** to **D** = 55, **E** to **E** = 50.8  
 Hole size:  
**A, B, C, D** = 6.9 x 32, **E** = 6.9 x 89.4

- 10-ga. (3.4 mm) cold-rolled steel with zinc finish
- Retrofit WORLD-BEAM QS30 in place of MULTI-BEAM, MAXI-BEAM, Q45, OMNI-BEAM and VALU-BEAM sensors

Used with:  
 QS30\*  
 \* Requires a **SMBAMS30RA** bracket (sold separately)

**SMBAMS30RA** (All measurements in mm)

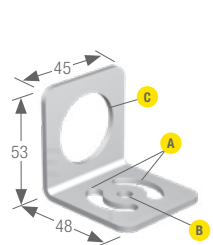

Hole center spacing:  
**A** = 26, **A** to **B** = 13  
 Hole size:  
**A** = 26.8 x 7, **B** =  $\varnothing$  6.5, **C** =  $\varnothing$  31

- Right-angle SMBAMS series bracket with 30 mm hole for mounting sensors
- Articulation slots for 90+° rotation
- 12-ga. (2.6 mm) cold-rolled steel

Used with:	T30U	VTB	QT50U	SM30/SMI30	EZ-LIGHT T30
	QS30	Q40	STB	WL50 Work Lights	EZ-LIGHT K50L
	S30	Q45	Q45U	OMNI-BEAM	LIGHT TL50
	T30	OTB/LTB	Q45UR		EZ-LIGHT CL50

**SMBQS30L** (All measurements in mm)

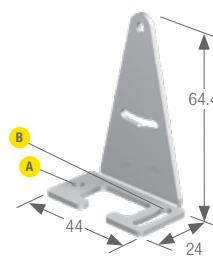

Hole center spacing:  
**A** to **B** = 35  
 Hole size:  
**A** =  $\varnothing$  4.3, **B** = 4.25 x 16.3

- Right-angle bracket for cable sensor models
- Clearance for M4 (#8) hardware
- ± 12° tilt adjustment
- 14-ga. stainless steel

Used with:  
 QS30

**SMBQS30LT** (All measurements in mm)

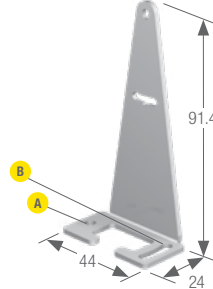

Hole center spacing:  
**A** to **B** = 35  
 Hole size:  
**A** =  $\varnothing$  4.3, **B** = 4.25 x 16.3

- Tall right-angle bracket for QD models
- ± 8° tilt adjustment
- 14-ga. stainless steel

Used with:  
 QS30 with integral QDs

**SMBQS30Y** (All measurements in mm)

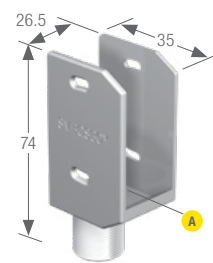

Hole size:  
**A** =  $\varnothing$  15.3

- Heavy-duty die-cast bracket
- M18 vertical mount option
- ± 8° tilt adjustment with cabled units
- Includes nuts and lock washer

Used with:  
 QS30 (DC only)

**SMBQS30YL** (All measurements in mm)

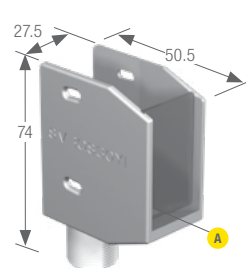

Hole size:  
**A** =  $\varnothing$  15.3

- Heavy-duty die-cast bracket designed for industrial protection
- Replaceable window
- M18 vertical mount option
- Includes nuts and lock washer

Used with:  
 QS30 (DC only)

**SMB30UR** (All measurements in mm)

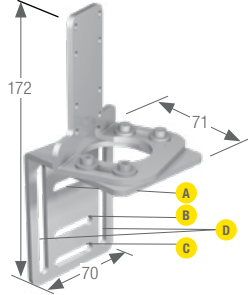

Hole center spacing:  
**A** to **B** = 31.8, **B** to **C** = 19,  
**A** to **C** = 50.8, **D** = 50.8  
 Hole size:  
**A**, **B**, **C** = 6.9 x 32, **D** = 73 x 6.9

- 2-piece universal swivel bracket for limit-switch style sensors
- 300 series stainless steel
- Stainless steel swivel locking hardware included

Used with:  
 Q45  
 OMNI-BEAM

Q45U  
 Q45UR

**SMB42F** (All measurements in mm)

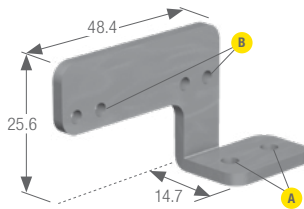

Hole center spacing:  
**A** = 10, **B** = 25.4  
 Hole size:  
**A** =  $\varnothing$  3.4, **B** =  $\varnothing$  2.5

- 13-ga. stainless steel
- Hardware included

Used with:  
 QM42/QMT42

**SMB42L** (All measurements in mm)

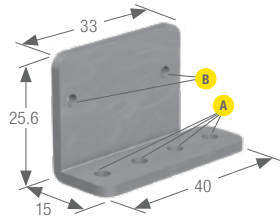

Hole center spacing:  
**A** = 10, **B** = 25.4  
 Hole size:  
**A** =  $\varnothing$  3.4, **B** =  $\varnothing$  2.5

- 13-ga. stainless steel
- Hardware included

Used with:  
 QM42/QMT42

**SMB42T** (All measurements in mm)

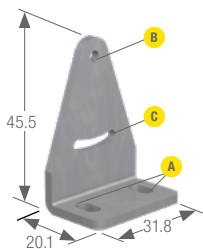

Hole center spacing:  
**A** = 20.3, **B** to **C** = 5.1  
 Hole size:  
**A** = 4.3 x 7.5, **B** =  $\varnothing$  3, **C** = 3 x 15.3

- Stainless steel 2-axis side-mounting bracket
- Nut strap included for replacing two M3 mounting nuts

Used with:  
 QM42/QMT42

**SMB42U** (All measurements in mm)

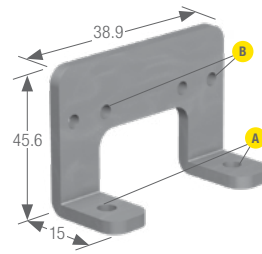

Hole center spacing:  
**A** = 30, **B** = 25.4  
 Hole size:  
**A** =  $\varnothing$  3.4, **B** =  $\varnothing$  2.5

- 13-ga. stainless steel
- Hardware included

Used with:  
 QM42/QMT42

**SMBAMSQ60IP** (All measurements in mm)

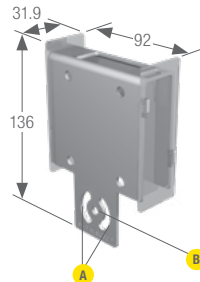

Hole center spacing:  
**A** = 26, **A** to **B** = 13  
 Hole size:  
**A** = 26.8 x 7, **B** =  $\varnothing$  6.5

- Industrial protection SMBAMS series bracket for Q60 with replaceable window
- Articulation slots for 90+° rotation
- 12-ga. (2.6 mm) 300 series stainless steel

Used with:  
 Q60

**SMBAMSQ60P** (All measurements in mm)

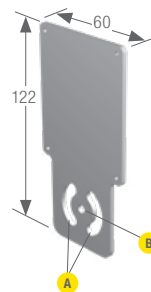

Hole center spacing:  
**A** = 26, **B** = 13  
 Hole size:  
**A** = 26.8 x 7, **B** =  $\varnothing$  6.5

- Flat SMBAMS series bracket for mounting Q60
- Articulation slots for 90+° rotation
- 12-ga. 300 series stainless steel

Used with:  
 Q60

**SMBQ60** (All measurements in mm)

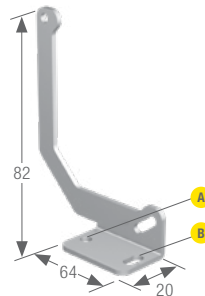

Hole center spacing:  
**A** to **B** = 24.1  
 Hole size:  
**A** =  $\varnothing$  4.5, **B** = 8.4 x 4.5

- Right-angle bracket
- 14-ga. 304 stainless steel

Used with:  
 Q60

**SMBSL** (All measurements in mm)

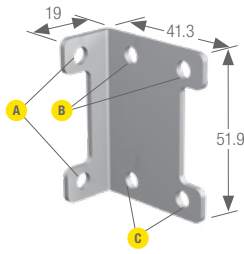

Hole center spacing:  
**A** = 40, **B**, **C** = 21.6, **B** to **C** = 39.9  
 Hole size:  
**A**, **B**, **C** =  $\varnothing$  5.5

- Right-angle bracket
- 304 stainless steel
- Hardware included

Used with:  
 SL10  
 SL30

**SMBLX** (All measurements in mm)

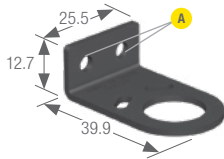

Hole center spacing:  
**A** = 12.7  
 Hole size:  
**A** =  $\varnothing$  4.3

- End-cap brackets; set of 2
- Zinc-plated cold-rolled steel

Used with:  
 LX

**SMBLXR** (All measurements in mm)

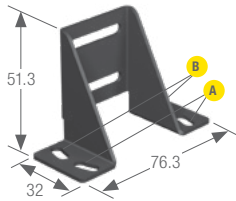

Hole center spacing:  
**A**, **B** = 63.5, **A** to **B** = 10.2  
 Hole size:  
**A**, **B** = 5.2 x 11.6

- Back-mount bracket for secure one-end mounting
- Zinc-plated cold-rolled steel

Used with:  
 LX

**SMBLH1** (All measurements in mm)

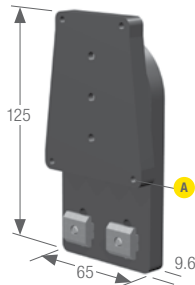

Hole size:  
**A** = M4

- Main mounting bracket for LH sensor
- T-slot or "bolt-on" bracket for mounting one sensor
- Anodized Aluminum

Used with:  
 LH

**SMBLH..** (All measurements in mm)

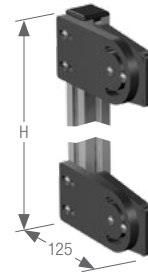

Hole size:  
**A** = M4

- LH series adjustable bracket
- Brackets for thickness and displacement measurement
- Anodized Aluminum

Used with:  
 LH

**SMBLG** (All measurements in mm)

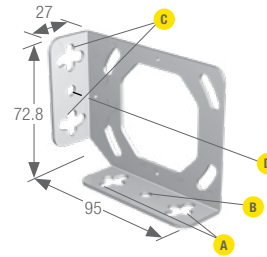

Hole center spacing:  
**A** = 56, **A** to **B** = 20, **C** = 44.5, **C** to **D** = 14  
 Hole size:  
**A** = 19.1 x 14.2, **B** =  $\varnothing$  6.3, **C** = 19.3 x 15.3, **D** =  $\varnothing$  6.3

- LG series sensor mounting bracket
- 304 stainless steel

Used with:  
 LG5  
 LG10

**SMBLGA** (All measurements in mm)

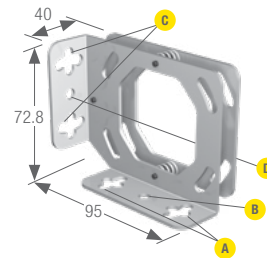

Hole center spacing:  
**A** = 56, **A** to **B** = 20, **C** = 44.5, **C** to **D** = 14  
 Hole size:  
**A** = 19.1 x 14.2, **B** =  $\varnothing$  6.3, **C** = 19.3 x 15.3, **D** =  $\varnothing$  6.3

- LG series adjustable bracket assembly
- Precision adjustment screws
- 304 stainless steel

Used with:  
 LG5  
 LG10

**SMBLT31** (All measurements in mm)

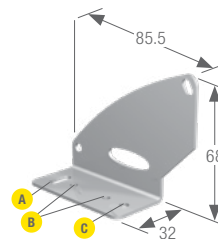

Hole center spacing:  
**A** to **C** = 47.5, **B** to **B** = 24.1  
 Hole size:  
**A** = 13.2 x 5, **B** =  $\varnothing$  4, **C** =  $\varnothing$  5

- Right-angle bracket
- 300 stainless steel

Used with:



**SMBLT32** (All measurements in mm)

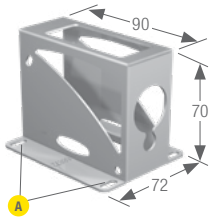

Hole center spacing:  
**A** = 80  
 Hole size:  
**A** = 5 x 12

- Full protection bracket
- 300 stainless steel
- Mounting hardware included

Used with:  
 LT3

**SMBLT3IP** (All measurements in mm)

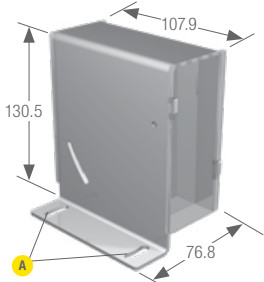

Hole center spacing:  
**A** = 82.5  
 Hole size:  
**A** = 6 x 20.5

- Protective bracket with replaceable window
- Stainless steel construction
- Includes replacement windows

Used with:  
 LT3

**SMBLT7F** (All measurements in mm)

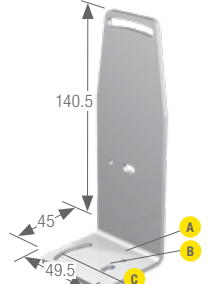

Hole center spacing:  
**A** to **C** = 31.8  
 Hole size:  
**A** =  $\varnothing$  3.1, **B** = 5 x 9, **C** = 5.2 x 28

- Fine-adjust accessory for bracket SMBLT7
- Mounting hardware included
- SMBLT7 required (sold separately)
- Cold-rolled steel

Used with:  
 TL7

**SMBLT7F** (All measurements in mm)



- Fine-adjust accessory for bracket SMBLT7
- Mounting hardware included
- SMBLT7 required (sold separately)
- Cold-rolled steel

Used with:  
 LT7\*  
 \*Shown mounted on **SMBLT7** (sold separately)

**SMBM25A** (All measurements in mm)

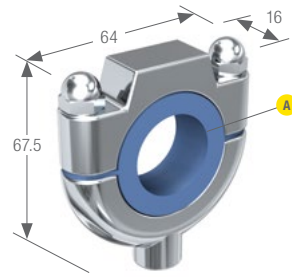

Hole size:  
**A** =  $\varnothing$  25.4

- Top mount swivel bracket
- Stainless steel with rounded edges for cleanliness in demanding environments
- Non-metallic FDA compliant bushing for acoustically isolating M25U sensors
- M10 x 1.5 mount on opposite side of clamping nuts

Used with:  
 M25U

**SMBM25B** (All measurements in mm)

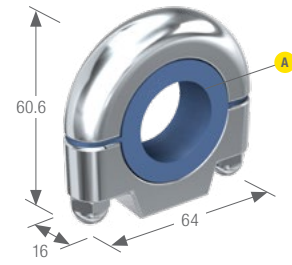

Hole size:  
**A** =  $\varnothing$  25.4

- Bottom mount swivel bracket
- Stainless steel with rounded edges for cleanliness in demanding environments
- Non-metallic FDA compliant bushing for acoustically isolating M25U sensors
- M10 x 1.5 mount on same side as clamping nuts

Used with:  
 M25U

**SMBLBCZB** (All measurements in mm)

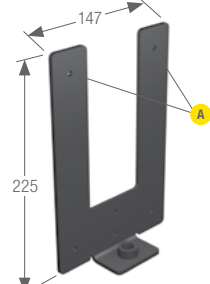

Hole center spacing:  
**A** = 107  
 Hole size:  
**A** =  $\varnothing$  5.2

- U-shaped bracket for mounting EZ-ARRAY emitter/receiver 67 mm apart
- 8-ga. (4 mm) cold-rolled steel, black zinc plated

Used with:  
 EZ-ARRAY

**MSMB-3** (All measurements in mm)

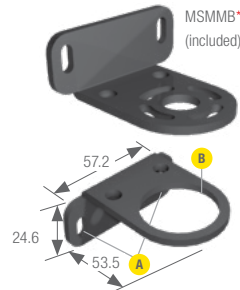

Hole center spacing:  
**A** = 44.5  
 Hole size:  
**A** = 10.2 x 4.8, **B** =  $\varnothing$  30.5

- Two-bracket replacement kit for emitter/receiver
- 11-ga. cold-rolled steel with black corrosion-resistant zinc chromate finish

\* Includes 1 bracket from model MSMMB (see page 903 for dimensions).

Used with:  
 High-Resolution MINI-ARRAY  
 MINI-ARRAY

**SMB55A** (All measurements in mm)

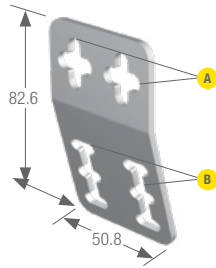

Hole center spacing:  
**A** = 24.1, **B** = 27.9  
 Hole size:  
**A** = 12.7 x 11.4, **B** = 24.8 x 7.6

- 15° offset bracket
- 12-ga. stainless steel

Used with:  
 R58E/R58A  
 QL56

**SMB55F** (All measurements in mm)

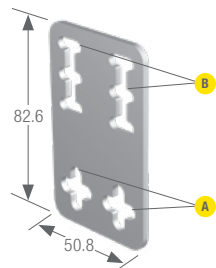

Hole center spacing:  
**A** = 24.1, **B** = 27.9  
 Hole size:  
**A** = 12.7 x 11.4, **B** = 24.8 x 7.6

- Flat-mount bracket
- 12-ga. stainless steel

Used with:  
 R58E/R58A  
 QL56

**SMB55RA** (All measurements in mm)

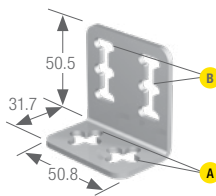

Hole center spacing:  
**A** = 24.1, **B** = 27.9  
 Hole size:  
**A** = 12.7 x 11.4, **B** = 24.8 x 7.6

- Right-angle bracket
- 12-ga. stainless steel

Used with:  
 R58E/R58A  
 QL56

**SMB55S** (All measurements in mm)

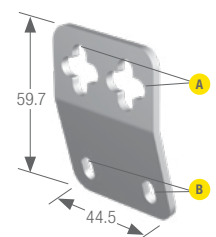

Hole center spacing:  
**A** = 30.5, **B** = 28  
 Hole size:  
**A** = 12.7 x 11.4, **B** = 5.2 x 8.9

- 15° offset bracket
- 12-ga. stainless steel

Used with:  
 R58E/R58A  
 QL56

**SMBQC50** (All measurements in mm)

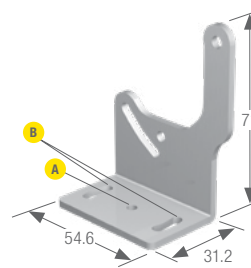

Hole center spacing:  
**A** to **B** = 18, **B** to **B** = 36  
 Hole size:  
**A** =  $\varnothing$  4, **B** = 4 x 13.3

- Multidirectional stainless steel right-angle bracket
- Variety of mounting options

Used with:  
 QC50  
 QCX50

**SMBIVUB** (All measurements in mm)

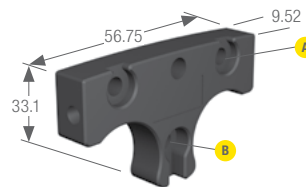

Hole center spacing:  
**A** = 35, **A** to **B** = 18  
 Hole size:  
**A**, **B** =  $\varnothing$  4.4

- Bottom mounting bracket
- Black anodized aluminum
- Hardware included

Used with:  
 iVu TG

**SMBIVURAL** (All measurements in mm)

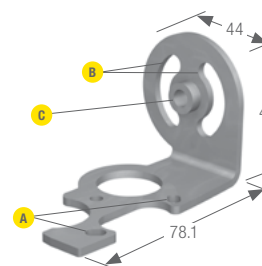

Hole center spacing:  
**A** = 36.4, **B** = 26  
 Hole size:  
**A** = 4.4 x 6.4, **B** = 7 x 26, **C** = 1/4-20

- Right-angle bracket for mounting sensor from the left
- 12-ga. stainless steel
- Hardware included

Used with:  
 iVu  
 iVu Plus

**SMBIVURAR** (All measurements in mm)

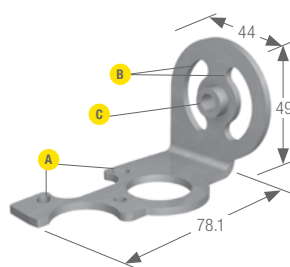

Hole center spacing:  
**A** = 36.4, **B** = 26  
 Hole size:  
**A** = 4.4 x 6.4, **B** = 7 x 26, **C** = 1/4-20

- Right-angle bracket for mounting sensor from right
- 12-ga. stainless steel
- Hardware included

Used with:  
 iVu  
 iVu Plus



**SMBIVUU** (All measurements in mm)

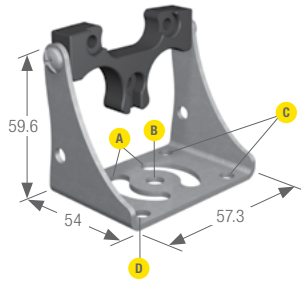

Hole center spacing:  
**A** = 26, **C** = 30, **C** to **D** = 42  
 Hole size:  
**A** = 6.5 x 3.6, **B** =  $\varnothing$  6.6, **C**, **D** = 5.4

- U-shaped swivel bracket kit
- 14-ga. stainless steel
- Hardware included

Used with:  
 iVu  
 iVu Plus

**SMBPPLU** (All measurements in mm)

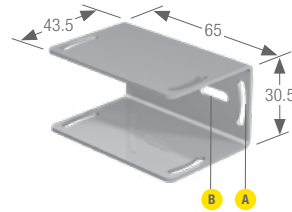

Hole center spacing:  
**A** = 58.5, **B** = 30  
 Hole size:  
**A** = 18.7 x 3.4, **B** = 14.3 x 4.4

- Highly stable U-Shaped bracket
- Bright corrosion-resistant finish
- Hardware included

Used with:  
 Presence PLUS Pro Camera

**SMBP4RAB** (All measurements in mm)

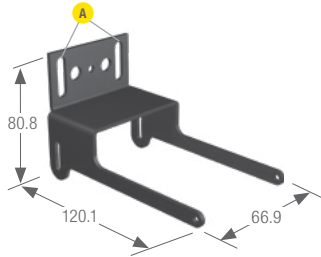

Hole center spacing:  
**A** = 47  
 Hole size:  
**A** = 3.3 x 19.1

- Heavy-duty, black corrosion-resistant zinc finish
- 8° of rotation on image-axis
- Hardware included

Used with:  
 P4 (right-angle)

**SMBPPRA** (All measurements in mm)

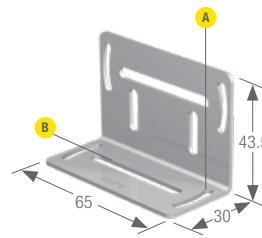

Hole center spacing:  
**A** = 58.5  
 Hole size:  
**A** = 18.7 x 3.4, **B** = 44.5 x 4.4

- Right-angle bracket with single-side mounting for difficult-to-access sites
- Bright corrosion-resistant finish
- Hardware included

Used with:  
 Presence PLUS Pro Camera

**SMBP4RAS** (All measurements in mm)

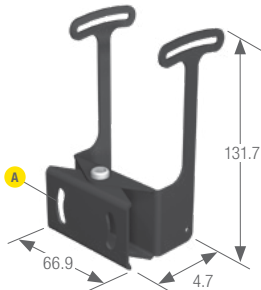

Hole center spacing:  
**A** = 43.5  
 Hole size:  
**A** = 6.8 x 2.5

- Right-angle swivel bracket
- 70° rotation on image's x-axis and 20° on the y-axis
- Black corrosion-resistant zinc finish
- Hardware included

Used with:  
 P4 (right-angle)

**SMBPPROMRA** (All measurements in mm)

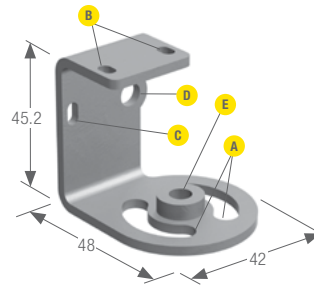

Hole center spacing:  
**A** = 26, **B** = 20, **C** to **D** = 20  
 Hole size:  
**A** = 7 x 26, **B** = 3.6 x 5.6, **C** = 3.6 x 6.6,  
**D** =  $\varnothing$  6.8, **E** =  $\varnothing$  8 (1/4-20)

- Right-angle bracket
- 316 stainless steel
- Hardware included

Used with:  
 Presence PLUS Pro Camera

**SMBP4SRAF** (All measurements in mm)

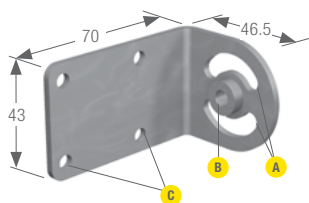

Hole center spacing:  
**A** to **B** = 12.5, **C** = 36  
 Hole size:  
**A** = 7 x 26, **B** =  $\varnothing$  8 (1/4-20),  
**C** =  $\varnothing$  5.5

- Right-angle, stainless steel bracket
- Stainless steel hardware included

Used with:  
 P4 (sealed)

**SMBPPU** (All measurements in mm)

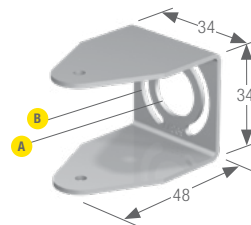

Hole center spacing:  
**B** = 25  
 Hole size:  
**A** =  $\varnothing$  16, **B** = 3.3 x 25

- U-Shaped swivel bracket for variable rotation
- Bright corrosion-resistant finish
- Hardware included

Used with:  
 Presence PLUS Pro Camera

**SMBPPSU** (All measurements in mm)

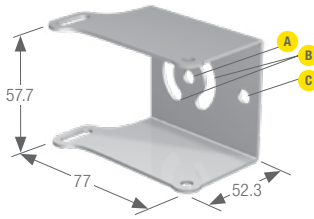

Hole center spacing:  
**A** to **C** = 31.8, **B** = 25  
 Hole size:  
**A** =  $\varnothing$  6.5, **B** = 20.2 x 7,  
**C** =  $\varnothing$  6.5

- 316 stainless steel
- 10° of rotation on image's y-axis
- Hardware included

Used with:  
 Presence PLUS Pro Camera

**SMBPPDE** (All measurements in mm)

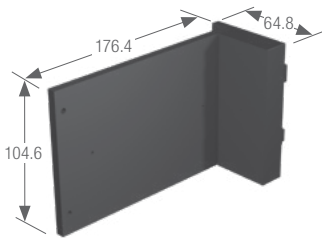

N/A

- DIN-rail edge mounting bracket to save linear track space
- Black ABS plastic
- Hardware included

Used with:  
 Presence PLUS Pro Controller

**SMBPPDH** (All measurements in mm)

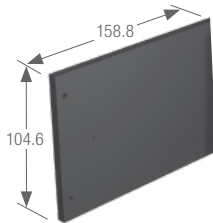

N/A

- DIN-rail flat mounting for easy viewing of LED's
- Black ABS plastic
- Hardware included

Used with:  
 Presence PLUS Pro Controller

**SMBP42ASM** (All measurements in mm)

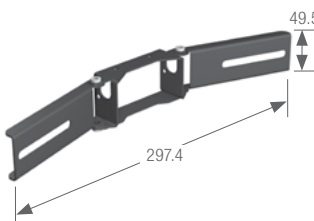

N/A

- For mounting two lights to P4 sensor housing
- Black corrosion-resistant zinc finish
- Hardware included

Used with:  
 Area Light (80 x 80 mm)\*  
 Area Light (62 x 62 mm)

Spot Light

**SMBP4ASM\*** (All measurements in mm)



N/A

- For mounting light to P4 sensor housing
- Black corrosion-resistant zinc finish
- Hardware included

Used with:  
 Area Light (80 x 80 mm)\*  
 Area Light (62 x 62 mm)

Spot Light

**SMBP40AL100** (All measurements in mm)



Hole center spacing:  
**A** = 15  
 Hole size:  
**A** =  $\varnothing$  5.3

- For mounting On-Axis light to P4 housing
- Centers lens on light opening
- Black zinc-plated steel
- Hardware included

Used with:  
 On-Axis Lights (100 mm)

\* Dimensions include 100 mm light (sold separately)

**SMBP40AL50** (All measurements in mm)



Hole center spacing:  
**A** = 15  
 Hole size:  
**A** =  $\varnothing$  5.3

- For mounting On-Axis light to P4 housing
- Centers lens on light opening
- Black zinc-plated steel
- Hardware included

Used with:  
 On-Axis Lights (50 mm)

**SMBPMPRHI** (All measurements in mm)

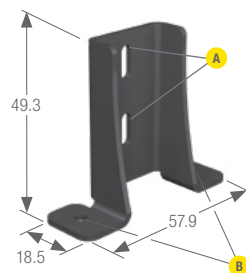

Hole center spacing:  
**A** = 20.1, **B** = 44.8  
 Hole size:  
**A** = 3.5 x 9.9, **B** = 3.8

- Black zinc plated steel
- For mounting light to Pro Mini Camera
- Black zinc plated finish
- Hardware included

Used with:  
 Ring Light (70 mm)

\* Requires one SMBACM bracket with each light (see page 886)

**SMBPPOAL100** (All measurements in mm)

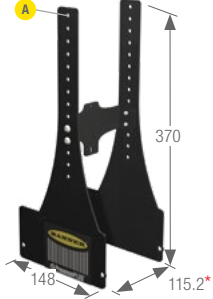

Hole center spacing:

**A** = 15

Hole size:

**A** =  $\varnothing$  5.3

- For mounting On-Axis light to Pro housing
- Centers lens on light opening
- Black zinc-plated steel
- Hardware included

Used with:  
On-Axis Lights (100 mm)

**SMBPPOAL50** (All measurements in mm)



Hole center spacing:

**A** = 15

Hole size:

**A** =  $\varnothing$  5.3

- For mounting On-Axis light to Pro housing
- Centers lens on light opening
- Black zinc-plated steel
- Hardware included

Used with:  
On-Axis Lights (50 mm)

**SMBPPRHI** (All measurements in mm)

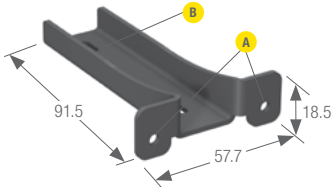

Hole center spacing:

**A** = 44.5, **B** = 52.3

Hole size:

**A** =  $\varnothing$  3.8, **B** = 3.6 x 6.4

- Black anodized aluminum bracket
- For mounting light to Pro camera
- Hardware included

Used with:  
Ring Light (70 mm)

**SMBBSSM** (All measurements in mm)

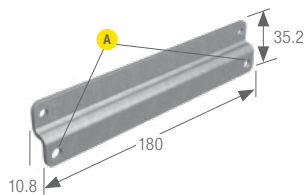

Hole center spacing:

**A** = 167.8

Hole size:

**A** =  $\varnothing$  5.5

- Surface-mount bracket
- 316 stainless steel
- Stainless steel hardware included
- Set of two brackets

Used with:  
Backlights (75 x 150 mm)  
Backlights (150 x 150 mm)

Backlights (150 x 225 mm)  
Backlights (150 x 300 mm)  
WLA Work Lights

**SMBBSRA** (All measurements in mm)

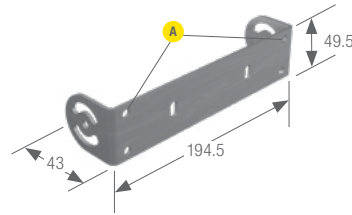

Hole center spacing:

**A** = 167.8

Hole size:

**A** =  $\varnothing$  6.5

- Swivel bracket for versatile orientation
- 316 stainless steel hardware

Used with:  
WLA Work Lights

**SMBASCM** (All measurements in mm)

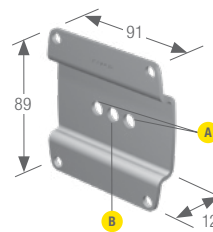

Hole center spacing:

**A** = 25.4, **A** to **B** = 12.7

Hole size:

**A** =  $\varnothing$  5 (M16), **B** =  $\varnothing$  5 (1/4-20)

- Column-mount bracket
- 316 stainless steel
- Stainless steel hardware included

Used with:  
NOTE: Shown with optional SMBPPK6 mounting kit.

**SMBABM** (All measurements in mm)

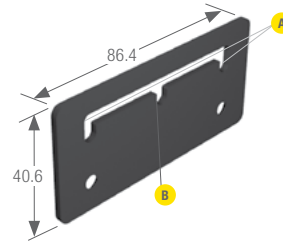

Hole center spacing:

**A** = 61, **A** to **B** = 30.5

Hole size:

**A**, **B** = 9.1 x 2.3

- Surface-mount bracket for mounting light from front
- Black corrosion-resistant zinc finish
- Hardware included

Used with:  
Area Lights (80 x 80 mm)  
Backlights (70 x 70 mm)

**SMBACM** (All measurements in mm)

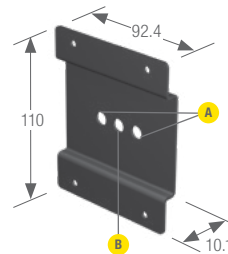

Hole center spacing:

**A** = 30, **A** to **B** = 15

Hole size:

**A** =  $\varnothing$  5 (M16), **B** =  $\varnothing$  5 (1/4 - 20)

- Column-mount bracket
- Black corrosion-resistant zinc finish
- Hardware included

Used with:  
Area Lights (80 x 80 mm)  
Backlights (70 x 70 mm)

NOTE: Shown with optional SMBPPK6 mounting kit.

\* Requires one SMBACM bracket with each light (see page 886)

**SMBAMS70A** (All measurements in mm)

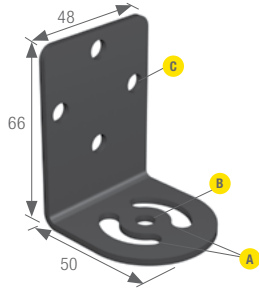

Hole center spacing:  
**A** = 26, **A** to **B** = 13  
 Hole size:  
**A** = 26.8 x 7, **B** =  $\varnothing$  6.5, **C** =  $\varnothing$  7

- Right-angle zinc-plated cold-rolled steel
- Articulated slots for 90+° rotation
- Two 1/4-20 screws included

Used with:  
 Area Light (70 mm)

**SMBAMS70AS** (All measurements in mm)

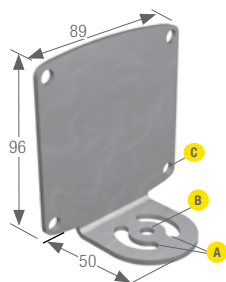

Hole center spacing:  
**A** = 26, **A** to **B** = 13  
 Hole size:  
**A** = 26.8 x 7, **B** =  $\varnothing$  6.5, **C** =  $\varnothing$  7

- Right-angle, 12-ga. 316 stainless steel
- Articulated slots for 90+° rotation
- Four 1/4-20 stainless steel screws included

Used with:  
 Sealed Area Light (70 mm)

**SMBWFTLS** (All measurements in mm)

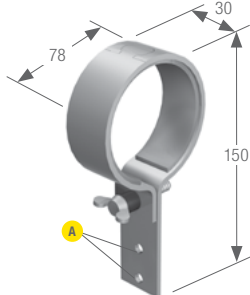

Hole center spacing:  
**A** = 27  
 Hole size:  
**A** =  $\varnothing$  6.5

- In-line bracket
- Mounts around light
- Bright zinc-coated steel construction

Used with:  
 Tubular Fluorescent Lights

**SMBWFTLR** (All measurements in mm)

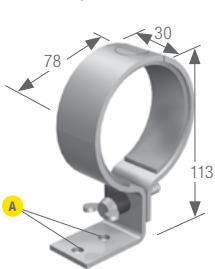

Hole center spacing:  
**A** = 27  
 Hole size:  
**A** =  $\varnothing$  6.5

- Right-angle bracket
- Mounts around light
- Bright zinc-coated steel construction

Used with:  
 Tubular Fluorescent Lights

**SMBLASRA** (All measurements in mm)

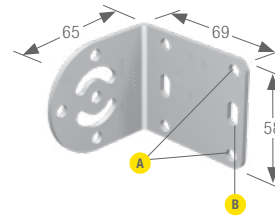

Hole center spacing:  
**A**, **B** = 45, **A** to **B** = 22.5  
 Hole size:  
**A** =  $\varnothing$  6.6, **B** = 6.6 x 12.4

- Right-angle metal bracket
- May be used individually or two used in combination
- 316 stainless steel bracket and hardware
- Set of two brackets

Used with:  
 Sealed Linear Array Lights (IP68)

**SMBLAXRA** (All measurements in mm)

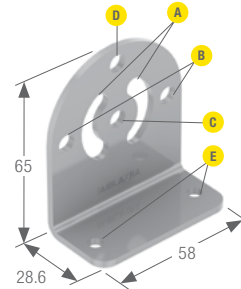

Hole center spacing:  
**A** = 26, **B** = 45,  
**C** to **D** & **B** to **C** = 22.5, **E** = 4.5  
 Hole size:  
**A** = 7 x 26, **B**, **C**, **D** =  $\varnothing$  6.6, **E** =  $\varnothing$  5.4

- Right-angle metal bracket
- May be used individually or with **SMBLAXU** to provide swivel adjustment
- 316 stainless steel bracket and hardware
- Set of two brackets

Used with:  
 Linear Array Lights (IP50)

**SMBLAXU** (All measurements in mm)

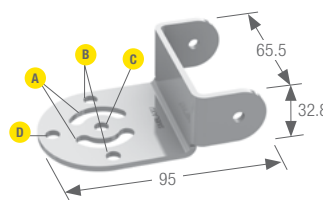

Hole center spacing:  
**A** = 25, **B** = 45,  
**C** to **D** & **B** to **C** = 22.5  
 Hole size:  
**A** = 7 x 26, **B**, **C**, **D** =  $\varnothing$  6.6

- U-shaped metal bracket
- Used with **SMBLAXRA** to provide swivel adjustment
- 316 stainless steel bracket and hardware
- Set of two brackets

Used with:  
 Linear Array Lights (IP50)

**SMBVLA62X62RA** (All measurements in mm)

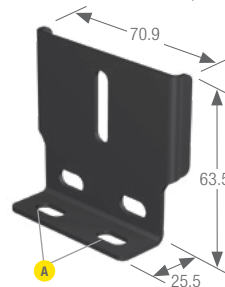

Hole center spacing:  
**A** = 36.4  
 Hole size:  
**A** = 13.1 x 6.6

- For mounting a light at a right angle
- 14-ga. steel, black zinc-plated

Used with:  
 Area Lights (62 x 62 mm)

**SMBAMS30PL52R** (All measurements in mm)

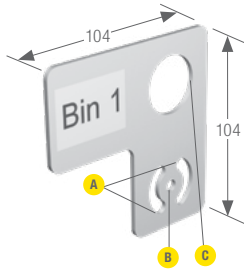

Hole center spacing:  
**A** = 26, **A** to **B** = 13  
 Hole size:  
**A** = 26.8 x 7, **B** =  $\varnothing$  6.5, **C** =  $\varnothing$  31

- Flat SMBAMS series bracket with space for 60 x 58 mm label
- 30 mm hole for mounting sensors
- Articulation slots for 90+° rotation
- 12-ga. (2.6 mm) cold-rolled steel

Used with:  
 EZ-LIGHT T30  
 VTB

EZ-LIGHT K50L

**SMBAMS30RLJ** (All measurements in mm)

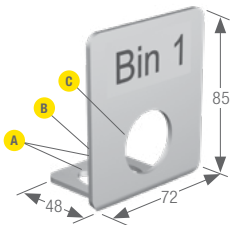

Hole center spacing:  
**A** = 26, **A** to **B** = 13  
 Hole size:  
**A** = 26.8 x 7, **B** =  $\varnothing$  6.5, **C** =  $\varnothing$  31

- Right-angle SMBAMS series bracket with 70 x 40 mm space for label
- 30 mm hole for mounting sensor
- Articulation slots for 90+° rotation
- 12-ga. (2.6 mm) cold-rolled steel

Used with:  
 EZ-LIGHT T30  
 VTB

EZ-LIGHT K50L  
 EZ-LIGHT CL50

**SMBAMS30RLS** (All measurements in mm)

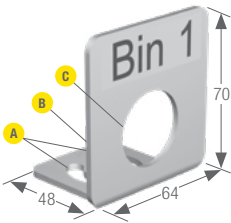

Hole center spacing:  
**A** = 26, **A** to **B** = 13  
 Hole size:  
**A** = 26.8 x 7, **B** =  $\varnothing$  6.5, **C** =  $\varnothing$  31

- Right-angle SMBAMS series bracket with 62 x 26 mm space for label
- 30 mm hole for mounting sensor
- Articulation slots for 90+° rotation
- 12-ga. (2.6 mm) cold-rolled steel

Used with:  
 EZ-LIGHT T30L  
 VTB

EZ-LIGHT K50L  
 EZ-LIGHT CL50

**SMBC18** (All measurements in mm)

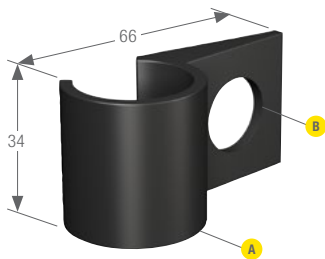

Hole center spacing:  
 N/A  
 Hole size:  
**A** =  $\varnothing$  26.9, **B** =  $\varnothing$  18.4

- Snaps onto 28 mm diameter structural framing

Used with:  
 S18L

**SA-K50A18** (All measurements in mm)

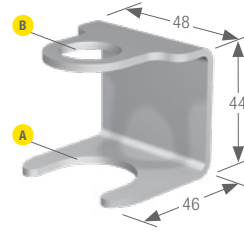

Hole center spacing:  
 Hole size:  
**A** =  $\varnothing$  30.5, **A** =  $\varnothing$  20

- Protective mounting bracket for EZ-LIGHT K50 sensors
- 12-ga. cold-rolled steel

Used with:  
 K50

**SMBARP..30** (All measurements in mm)

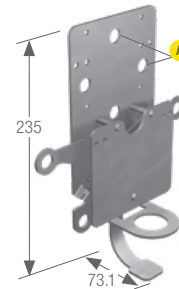

Hole center spacing:  
**A** = 69.9  
 Hole size:  
**A** =  $\varnothing$  12.8

Model	Rope Pull
SMBARPL30	Left
SMBARPR30	Right
SMBARPB30	Both

Used with:  
 K50

**SMBPVA1** (All measurements in mm)

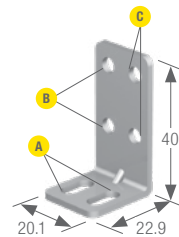

Hole center spacing:  
**A** = 10.2, **B** to **B** = 18, **B** to **C** = 10.2  
 Hole size:  
**A** = 10 x 4.8, **B**, **C** =  $\varnothing$  4.6

- Right-angle bracket
- 303 stainless steel
- Replacement brackets for brackets included with sensors

Used with:  
 PVA  
 PVD

EZ-LIGHT TL30F

**SMBPVA11** (All measurements in mm)

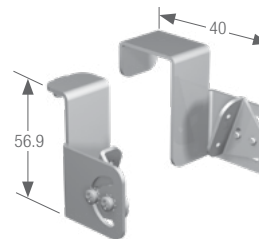

Hole center spacing:  
 NA  
 Hole size:  
 NA

- Pair of two-piece swivel brackets for mounting sensor to 5/16" metal rack system
- Articulation slot for  $\pm$ 90° rotation
- May be used with **SMBPVA..C** bracket

Used with:  
 PVD  
 EZ-LIGHT TL30F

SMBPVD..A  
 SMBPVD..AB

**SMBPVA2** (All measurements in mm)

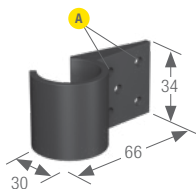

Hole center spacing:  
**A** = 18.8  
 Hole size:  
**A** =  $\varnothing$  4.4

- Set of 4 molded brackets
- Snaps onto standard 28 mm diameter pipe
- 2 required per sensor

Used with:  
 PVA SMBPVA..  
 PVD SMBPVA..A  
 EZ-LIGHT TL30F SMBPVA..AB

**SMBPVA..C** (All measurements in mm)

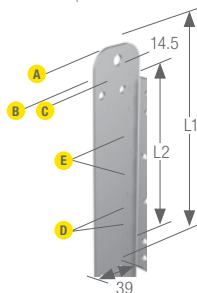

Hole center spacing: **A** to **C** = 20,  
**B** to **C** = 18, **D** = 13, **E** = 32  
 Hole size: **A** =  $\varnothing$  7.3,  
**B**, **C**, **D**, **E** =  $\varnothing$  5.2

- Back-mounted bracket for mounting to SMBPVA7 or SMBPVA8 brackets
- Cold-rolled steel with zinc finish

Models	L1	L2
SMBPVA5C	188.7	139.5
SMBPVA10C	317.2	268.0

Used with:  
 SMBPVA7\* SMBPVA...A  
 SMBPVA8\* SMBPVA...AB  
 SMBPVA... SMBPVD...A  
 SMBPVD...AB

PVA, PVD  
 \* Sensor must be mounted to a SMBPVA..C bracket.

**SMBPVA.., SMBPVA..A, SMBPVA..AB** (All measurements in mm)

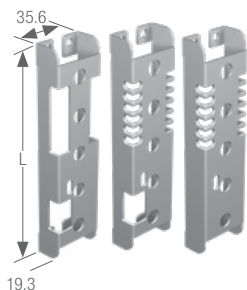

Models	DIP Switch Access	Light Protected	Length (L)	Used With
SMBPVA5	Yes	No		
SMBPVA5A	Yes	Yes	139.7	PVA100
SMBPVA5AB	No	Yes		
SMBPVA10	Yes	No		
SMBPVA10A	Yes	Yes	268.2	PVA225
SMBPVA10AB	No	Yes		
SMBPVA13	Yes	No		
SMBPVA13A	Yes	Yes	343.3	PVA300
SMBPVA13AB	No	Yes		
SMBPVA16	Yes	No		
SMBPVA16A	Yes	Yes	418.2	PVA375
SMBPVA16AB	No	Yes		

- Pair of brackets protects sensor from impact; provides DIP-switch and/or indicator light exposure (depending on model)
- Heavy-duty cold-rolled steel-zinc finish
- May be used with SMBPVA..C for mounting to SMBPVA7 or SMBPVA8 brackets

Used with:  
 PVA (see chart)  
 SMBPVA..2  
 SMBPVA..7\*  
 SMBPVA..8\*  
 SMBPVA..C bracket

\* Protective bracket must be mounted to a SMBPVA..C bracket.

**SMBPVA6** (All measurements in mm)

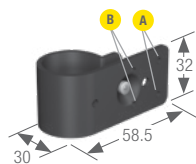

Hole center spacing:  
**A**, **B**, **A** to **B** = 18  
 Hole size:  
**A** =  $\varnothing$  3.2

- Set of 4 molded brackets
- Brackets clamp onto 28 mm pipe
- Request data sheet p/n 64900 for more information

Used with:  
 PVA EZ-LIGHT TL30F SMBPVA..  
 PVD SMBPVA.. SMBPVD..A SMBPVD..AB

**SMBPVA7** (All measurements in mm)

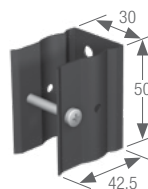

Hole center spacing:  
 N/A  
 Hole size:  
 N/A

- One-piece bracket for mounting to 28 mm diameter pipe
- Black-painted steel
- Requires SMBPVA..C for mounting at an angle  $\pm 90^\circ$

Used with:  
 PVA\* SMBPVA5C  
 PVD\* SMBPVA10C  
 \* Sensor must be mounted to SMBPVA..C bracket. (sold separately)

**SMBPVA8** (All measurements in mm)

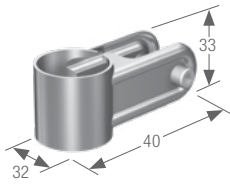

Hole center spacing:  
N/A  
Hole size:  
N/A

- Heavy-duty 2-part bracket mounts to 28 mm diameter pipe
- Cold-rolled steel with zinc finish
- Requires SMBPVA..C for mounting

Used with:  
PVA\* SMBPVA5C  
PVD\* SMBPVA10C

\* Sensor must be mounted to SMBPVA..C bracket. (sold separately)

**SMBPVA9** (All measurements in mm)

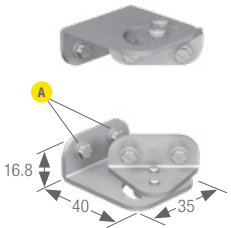

Hole center spacing:  
**A** = 18  
Hole size:  
**A** =  $\varnothing$  5

- Pair of 2-piece swivel brackets
- Mount directly to sensor or to PVD/PVA protective brackets
- Designed for mounting sensor to "look down"

Used with:  
PVA EZ-LIGHT TL30F  
PVD SMBPVA...

SMBPVA..A SMBPVA...AB  
SMBPVD...A SMBPVD...AB

**SMBPVL1** (All measurements in mm)

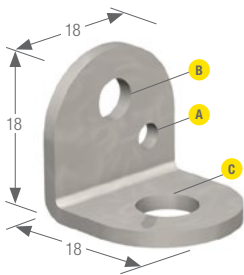

Hole center spacing:  
NA  
Hole size:  
**A** =  $\varnothing$  3, **B** =  $\varnothing$  4.8, **C** =  $\varnothing$  7

- 14 gauge cold rolled steel
- Right-angle bracket for mounting the pick-to-light array

Used with:  
PVL225  
PLV500

**SMBPVL4** (All measurements in mm)

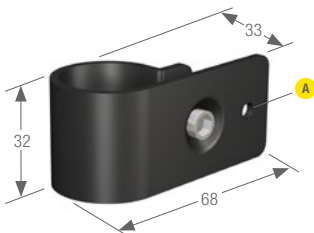

Hole center spacing:  
NA  
Hole size:  
**A** =  $\varnothing$  M6 x 1

- Painted cold rolled steel
- 28 mm tubular mount bracket for mounting outside bin
- Clearance for M6 (1/4 in) hardware

Used with:  
PVL225  
PLV500

**SMBPVL5** (All measurements in mm)

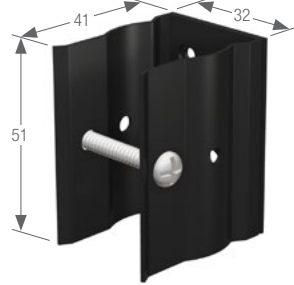

Hole center spacing:  
NA  
Hole size:  
NA

- Painted cold rolled steel
- 28 mm tubular mount bracket for mounting inside bin
- Clearance for M6 (1/4 in) hardware

Used with:  
PVL225  
PLV500

**SMBPVL2-225** (All measurements in mm)

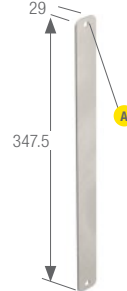

Hole center spacing:  
**A** = 331.5  
Hole size:  
**A** =  $\varnothing$  7

- 14 gauge cold rolled steel
- Flat bracket for mounting reflector inside bin
- Includes retroreflective tape

Used with:  
PVL225

**SMBPVL2-500** (All measurements in mm)

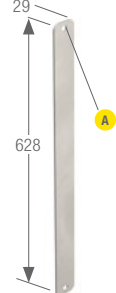

Hole center spacing:  
NA  
Hole size:  
**A** =  $\varnothing$  7

- 14 gauge cold rolled steel
- Flat bracket for mounting reflector inside bin
- Includes retroreflective tape

Used with:  
PLV500

**SMBPVL3-225** (All measurements in mm)

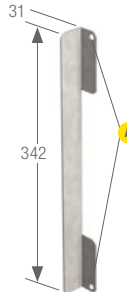

Hole center spacing:  
NA  
Hole size:  
**A** =  $\varnothing$  7

- 14 gauge cold rolled steel
- Right-angle bracket for mounting reflector outside bin
- Includes retroreflective tape

Used with:  
PVL225



**SMBPVL3-500** (All measurements in mm)

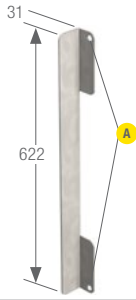

Hole center spacing:

Hole size:  
A =  $\varnothing 7$

- 14 gauge cold rolled steel
- Right-angle bracket for mounting reflector outside bin
- Includes retroreflective tape

Used with:  
PLV500

**EZA-MBK-1** (All measurements in mm)

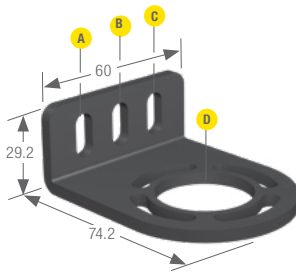

Hole center spacing:  
A to B = 15.8, A to C = 31.5

Hole size:  
A, B, C = 15 x 7,  
D =  $\varnothing 32$

- Two end-cap replacement brackets for one emitter/receiver
- 8-ga. cold-rolled steel with black corrosion-resistant zinc chromate finish
- M5 and M6 mounting hardware

Used with:  
EZ-SCREEN Point & Grid

**EZA-MBK-11** (All measurements in mm)

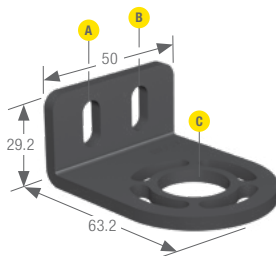

Hole center spacing:  
A to B = 20

Hole size:  
A, B = 15 x 7, C =  $\varnothing 21.5$

- Two end-cap replacement brackets for one emitter/receiver
- 8-ga. cold-rolled steel with black corrosion-resistant zinc chromate finish
- M5 and M6 mounting hardware

Used with:  
EZ-ARRAY  
EZ-SCREEN Standard 14 & 30 mm

**EZA-MBK-12** (All measurements in mm)

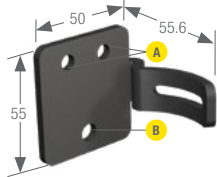

Hole center spacing:  
A = 20, A to B = 36

Hole size:  
A =  $\varnothing 7$ , B =  $\varnothing 8.3$

- Two-piece center bracket for one emitter/receiver
- 8-ga. cold-rolled steel with black corrosion-resistant zinc chromate finish
- M5 and M6 mounting hardware

Used with:  
EZ-ARRAY  
EZ-SCREEN Standard 14 & 30 mm

**EZA-MBK-2** (All measurements in mm)

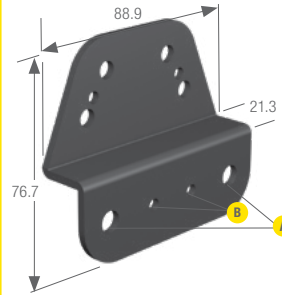

Hole center spacing:

A = 63.9, B = 19.9, A to B = 22

Hole size:  
A =  $\varnothing 8.3$ , B =  $\varnothing 4.8$

- Bracket adapter (Qty 2) for attaching EZA-MBK-1 to any MSA series stand

Used with:  
EZ-SCREEN Point & Grid  
MSA Stands

**EZA-MBK-20** (All measurements in mm)

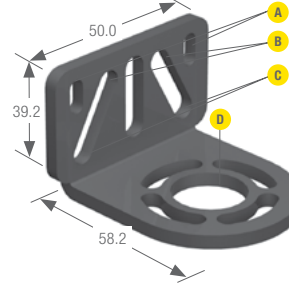

Hole center spacing:  
A = 44.4, B = 20, C = 40

Hole size:  
A = 10.2 x 4.8, B, C = 25 x 7, D =  $\varnothing 21.5$

- Two-bracket kit for one sensor
- Adapter brackets for mounting to engineered/slotted aluminum framing such as 80/20™ and Unistrut™
- Order EZA-MBK-20U for bracket and M5 and M6 mounting hardware

Used with:  
EZ-ARRAY  
EZ-SCREEN Standard 14 & 30 mm  
EZ-SCREEN Cascade 14 & 30 mm

**EZA-MBK-21** (All measurements in mm)

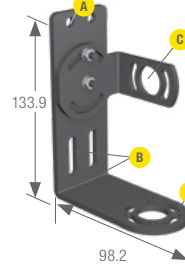

Hole center spacing:

A = 20, B = 20, A to B = 101.4

Hole size:  
A =  $\varnothing 7$ , B = 30 x 7.2, C, D =  $\varnothing 21.5$

- Mounting bracket system for L configuration of two cascaded EZ-SCREEN light screens
- 8-ga. cold-rolled steel with black corrosion-resistant zinc chromate finish
- M5 and M6 mounting hardware

Used with:  
EZ-SCREEN Cascade 14 & 30 mm

**EZA-MBK-3** (All measurements in mm)

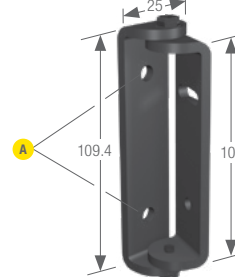

Hole center spacing:

A = 65

Hole size:  
A =  $\varnothing 7$

- Two-piece side-swivel bracket kit
- 180° range of motion
- 8-ga. cold-rolled steel with black corrosion-resistant zinc chromate finish

Used with:  
EZ-SCREEN Point & Grid



**EZA-MBK-4** (All measurements in mm)

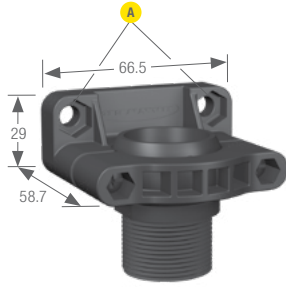

Hole center spacing:  
**A** = 50.8  
 Hole size:  
 ø 7

- Top-mounting kit with SMB30SC swivel bracket and threaded adapter
- 45° rotation in any direction
- Black reinforced thermoplastic polyester

Used with:  
 EZ-SCREEN Point

**EZA-MBK-5** (All measurements in mm)

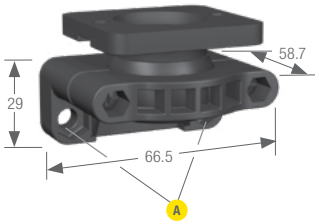

Hole center spacing:  
**A** = 50.8  
 Hole size:  
 ø 7

- Bottom-mounting kit with SMB30SC swivel bracket and threaded adapter plate
- 45° rotation in any direction
- Black reinforced thermoplastic polyester

Used with:  
 EZ-SCREEN Point

**EZA-MBK-9** (All measurements in mm)

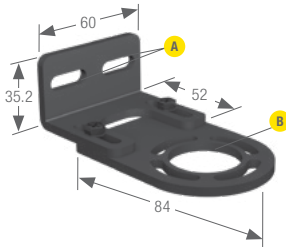

Hole center spacing:  
**A** = 30.8  
 Hole size:  
**A** = 21 x 7, **B** = ø 32

- Two-bracket kit with 30 mm range of motion for mounting sensor
- 8-ga. cold-rolled steel with black corrosion-resistant zinc chromate finish
- M5 and M6 mounting hardware

Used with:  
 EZ-SCREEN Grid & Point

**LPA-MBK-11** (All measurements in mm)

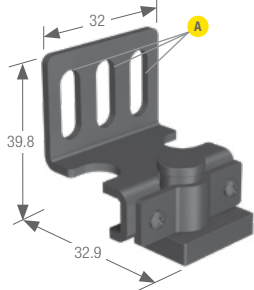

Hole center spacing:  
**A** = 10  
 Hole size:  
**A** = 5.5 x 15.5

End-cap bracket kit  
 360° sensor rotation  
 14-ga. (1.9 mm) steel, black zinc plated; die-cast metal clamp  
 Includes 2 brackets and hardware

Used with:  
 EZ-SCREEN LP 14 & 25 mm

**LPA-MBK-12** (All measurements in mm)

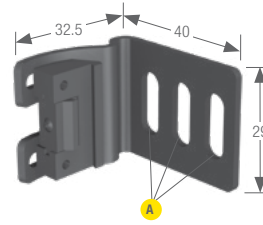

Hole center spacing:  
**A** = 10  
 Hole size:  
**A** = 15.5 x 5.5

- Side-mount bracket kit
- +10°/-30° sensor rotation
- 14-ga. (1.9 mm) steel, black zinc plated; die-cast zinc clamp
- Includes 1 bracket and hardware

Used with:  
 EZ-SCREEN LP 14 & 25 mm

**LPA-MBK-120** (All measurements in mm)

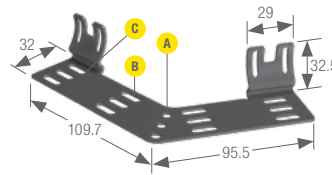

Hole center spacing:  
**A**, **B**, **C** = 10, **B** to **C** = 50  
 Hole size:  
**A** = ø 5.8, **B**, **C** = 15.5 x 5.5

- Pair of angled L brackets for two cascaded emitter/receiver pairs
- Fixed 120° orientation
- +10°/-30° sensor rotation
- 14-ga. (1.9 mm) steel, black zinc plated

Used with:  
 EZ-SCREEN LP Cascade 14 & 25 mm

**LPA-MBK-135** (All measurements in mm)

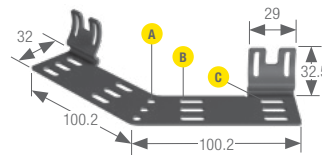

Hole center spacing:  
**A**, **B**, **C** = 10, **B** to **C** = 50  
 Hole size:  
**A** = ø 5.8, **B**, **C** = 15.5 x 5.5

- Pair of angled L brackets for two cascaded emitter/receiver pairs
- Fixed 135° orientation
- +10°/-30° sensor rotation
- 14-ga. (1.9 mm) steel, black zinc plated

Used with:  
 EZ-SCREEN LP Cascade 14 & 25 mm

**LPA-MBK-180** (All measurements in mm)

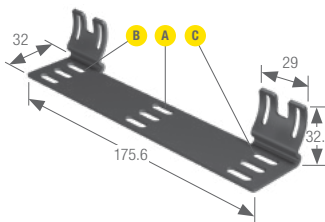

Hole center spacing:  
**A**, **B**, **C** = 10, **A** to **B** = 73.3,  
**A** to **C** = 73.3  
 Hole size:  
**A**, **B**, **C** = 15.5 x 5.5

- Pair of inline (straight) brackets for two cascaded emitter/receiver pairs
- Fixed 180° orientation
- +10°/-30° sensor rotation
- 14-ga. (1.9 mm) steel, black zinc plated

Used with:  
 EZ-SCREEN LP Cascade 14 & 25 mm

# ACCESSORIES

# BRACKETS

# CORDSETS

# RETROREFLECTORS

## LPA-MBK-20 (All measurements in mm)

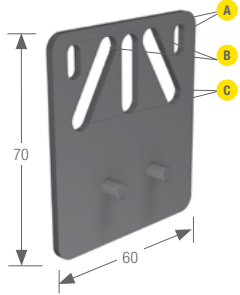

- Hole center spacing:  
**A** = 44.5, **B** = 20, **C** = 40  
 Hole size: **A** = 4.8 x 10.2, **B**, **C** = 7 x 26.8
- Universal adapter bracket for mounting to engineered/slotted aluminum framing (example, 80/20™, Bosch)
  - Use with LPA-MBK-11, -12 or -13
  - 12-ga. (2.66 mm) steel; black zinc plated
  - Includes 1 bracket and hardware

Used with:  
EZ-SCREEN LP 14 & 25 mm

## LPA-MBK-21 (All measurements in mm)

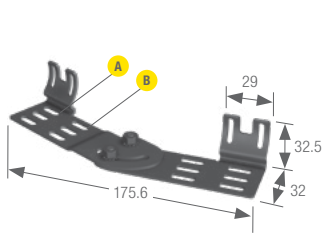

- Hole center spacing:  
**A**, **B** = 10, **A** to **B** =  
 Hole size:  
**A**, **B** = 15.5 x 5.5
- Pivoting "L" bracket system for two cascaded emitters/receivers; uses clamps from side-mount bracket LPA-MBK-12
  - Adjustable 90° to 180° orientation
  - +10°/-30° sensor rotation
  - 14-ga. (1.9 mm) steel, black zinc plated

Used with:  
EZ-SCREEN LP Cascade 14 & 25 mm

## LPA-MBK-22 (All measurements in mm)

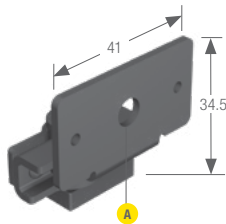

- Hole center spacing:  
 Hole size:  
**A** = ø 6.6
- End-cap bracket for mounting inside Unistrut® metal framing
  - Fits Unistrut® P1000 size (1 5/8"), with M6 or 1/4" channel nuts
  - 14-ga. (1.9 mm) steel, black zinc, plated; die-cast zinc clamp
  - Used with LPA-MBK-11
  - Includes 2 brackets and hardware (does not include Unistrut® channel nuts)

Used with:  
EZ-SCREEN LP 14 & 25 mm

## LPA-MBK-90 (All measurements in mm)

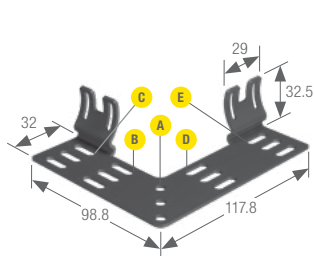

- Hole center spacing:  
**A**, **B**, **C**, **D**, **E** = 10, **B** to **C** = 30,  
**D** to **E** = 50  
 Hole size:  
**A** = ø 5.8,  
**B**, **C**, **D**, **E** = 15.5 x 5.5
- Pair of angled L brackets for two cascaded emitter/receiver pairs
  - Fixed 90° orientation
  - +10°/-30° sensor rotation
  - 14-ga. (1.9 mm) steel, black zinc plated

Used with:  
EZ-SCREEN LP Cascade 14 & 25 mm

## LPA-MBK-PXXX (All measurements in mm)

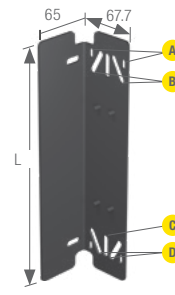

- Hole center spacing:  
**A** = 44.5, **B** = 40, **D** = 18  
 Hole size:  
**A** = 4.8 x 10.2, **B** = 7 x 26.8, **C** = 7 x 25
- L-shaped protective bracket for one emitter/receiver
  - Sized to match emitter/receiver length; replace XXX in model number with emitter/receiver size (example, LPA-MBK-P270 for use with SLP.-270)
  - +10°/-30° sensor rotation
  - 12-ga. (2.66 mm) steel, black zinc plated or painted

Used with:  
EZ-SCREEN LP 14 & 25 mm

## AG4-MBK1 (All measurements in mm)

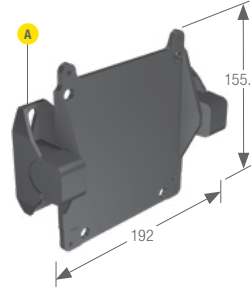

- Hole center spacing:  
**A** = 63  
 Hole size:  
 9 x 20.4
- Metal swivel bracket for mounting and aligning

Used with:  
AG4 Laser Scanner

## SSA-MBK-EEC1 (All measurements in mm)

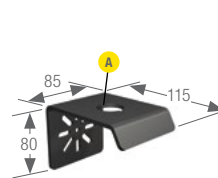

- Hole center spacing:  
 NA  
 Hole size:  
**A** = ø 30.5
- Allows for horizontal and vertical (post) mounting
  - 8 gauge steel, black finish (zinc-plated)

Used with:  
E-Stop Buttons

## SSA-MBK-EEC2 (All measurements in mm)

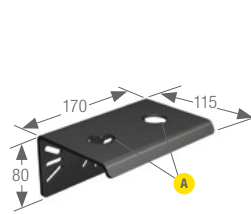

- Hole center spacing:  
**A** = 85  
 Hole size:  
**A** = ø 30.5
- Allows for horizontal and vertical (post) mounting
  - 8 gauge steel, black finish (zinc-plated)

Used with:  
E-Stop Buttons

**STBA-RB1-MB1** (All measurements in mm)

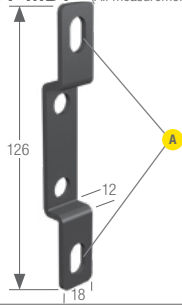

Hole center spacing:

**A** = 106

Hole size:

**A** = 9 x 15

- Pair of wall-mount brackets; run bar "hangs" on vertical surface
- Slotted holes for vertical adjustment
- 12-ga. cold-rolled steel with black powdercoat paint

Used with:  
DUO-TOUCH Run Bar

**STBA-RB1-MB2** (All measurements in mm)

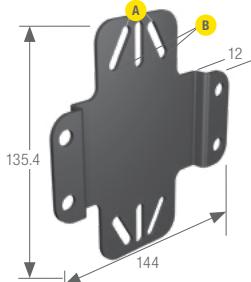

Hole center spacing:

**A** = 20, **B** = 40, **A** to **B** = 20

Hole size:

**A**, **B** = 27 x 7

- Universal-mount bracket; allows run bar to mount to vertical stand or surface
- Slotted holes for adjustment
- 12-ga. cold-rolled steel with black powdercoat paint

Used with:  
DUO-TOUCH Run Bar

**STBA-RB1-MB3** (All measurements in mm)

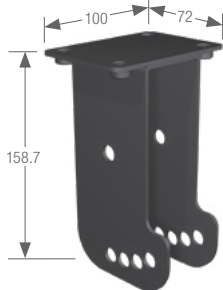

Hole center spacing:

NA

Hole size:

NA

- Swivel-mount bracket; mounts to telescoping stand
- Holes for radial adjustment, 0° to 30° in 10° increments
- 12-ga. cold-rolled steel with black powdercoat paint

Used with:  
DUO-TOUCH Run Bar

NOTE:  
Included with telescoping stands  
STBA-RB1-S1 and STBA-RB1-S2

**USCMB-..** (All measurements in mm)

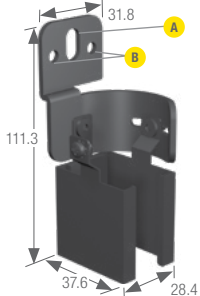

Hole center spacing:

**B** = 19.9, **A** to **B** = 10

Hole size:

**A** = 12.2 x 7.1, **B** =  $\varnothing$  4.8

- Two-piece center mounting replacement kit for bracket that comes with emitter/receiver
- 13-ga. cold-rolled steel with black powder coat paint
- Bracket hardware included

Used with:  
EZ-SCREEN Type 2

NOTE:  
USCMB-1 fits emitters/receivers 600 to 900 mm long  
USCMB-2 fits emitters/receivers 1050 mm and longer.

**USMB-1** (All measurements in mm)

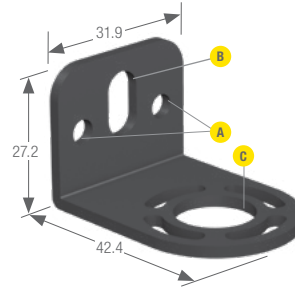

Hole center spacing:

**A** = 20, **A** to **B** = 10

Hole size:

**A** =  $\varnothing$  4.8, **B** = 12.7 x 7, **C** =  $\varnothing$  15.2

- Two-bracket replacement kit for brackets that come with emitter/receiver
- 13-ga. cold-rolled steel with black corrosion-resistant zinc chromate finish
- Bracket hardware included

Used with:  
EZ-SCREEN Type 2

**USMB-6** (All measurements in mm)

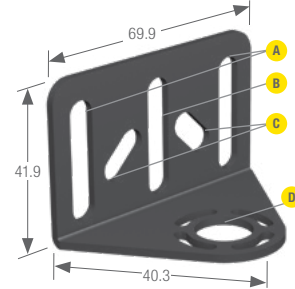

Hole center spacing:

**A** = 52.1, **A** to **B** = 26, **C** = 30.6

Hole size:

**A**, **B** = 25.4 x 7.1,  
**C** = 15.5 x 7, **D** =  $\varnothing$  15.2

- Two-bracket universal-mounting surface kit
- 13-ga. cold-rolled steel with black corrosion-resistant zinc chromate finish
- Bracket hardware included

Used with:  
EZ-SCREEN Type 2

**USMB-8** (All measurements in mm)

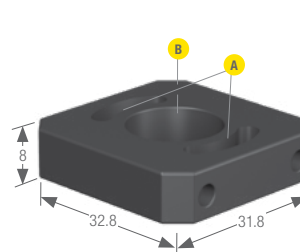

Hole center spacing:

**A** = 22.7

Hole size:

**A** = 15 x 3.5, **B** =  $\varnothing$  14.8

- Two-bracket kit for one emitter/receiver
- Mounting plate for 90° sensor direction
- Black anodized aluminum

Used with:  
EZ-SCREEN Type 2

**ED9Z-GH1** (All measurements in mm)

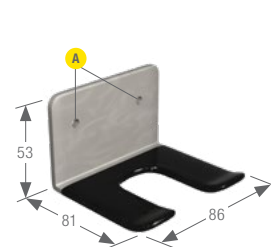

Hole center spacing:

**A** = 50

Hole size:

**A** =  $\varnothing$  5.3

- Right-angle bracket for mounting switch to upright surface
- Stainless steel

Used with:  
ED1G Enabling Devices

**RMB100** (All measurements in mm)

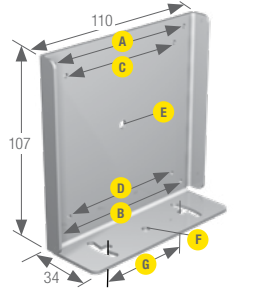

Hole center spacing:  
 A, B, A to B = 92,  
 C, D, C to D = 77, B = 56  
 Hole size:  
 A, B, C, D =  $\varnothing$  0.5,  
 E =  $\varnothing$  4.8, F =  $\varnothing$  4.5, G = 21.5 x 4.5

- Protective mounting bracket for retroreflective targets
- 14-ga. 316 stainless steel
- Stainless steel M3 x 0.5 hardware included

Used with:  
 BRT-3  
 BRT-84

BRT-77X77C  
 BRT-92X92C  
 BRT-92X92CB

**RMB50** (All measurements in mm)

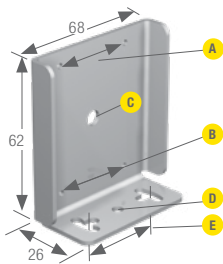

Hole center spacing:  
 A, B = 34, A to B = 52, E = 26  
 Hole size:  
 A, B =  $\varnothing$  0.5, C =  $\varnothing$  6.3, D =  $\varnothing$  4.5,  
 E = 13.8 X 4.5

- Protective mounting bracket for retroreflective targets
- 14-ga. 316 stainless steel
- Stainless steel M3 x 0.5 hardware included

Used with:  
 BRT-50D  
 BRT-50R  
 BRT-2X2

BRT-51X51BM  
 BRT-60X40AF  
 BRT-60X40C  
 BRT-60X40IP69K

**RMB85** (All measurements in mm)

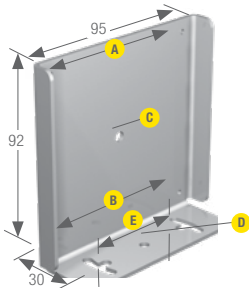

Hole center spacing:  
 A, B, A to B = 77, E = 46  
 Hole size:  
 A, B =  $\varnothing$  0.5, C =  $\varnothing$  4.8, D =  $\varnothing$  4.5,  
 E = 19 x 4.5

- Protective mounting bracket for retroreflective targets
- 14-ga. 316 stainless steel
- Stainless steel M3 x 0.5 hardware included

Used with:  
 BRT-3  
 BRT-77X77C

**SMB50RFA..** (All measurements in mm)

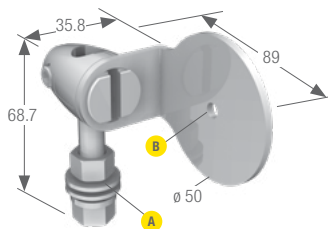

Model	Bolt Thread (A)
SMB50RFA	3/8 - 16 x 2"
SMB50RFAM10	M10 - 1.5 x 50

Hole center spacing:  
 Hole size:  
 B = 5.4

- Swivel bracket with tilt and pan movement for precision adjustment
- Easy sensor mounting to extruded rail T-slots
- 50 mm diameter plate for mounting a reflector

Used with:  
 BRT-35DM  
 BRT-50D

BRT-42D  
 BRT-34T

**SMBAMSR85P** (All measurements in mm)

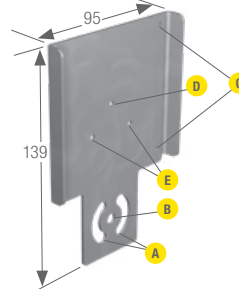

Hole center spacing:  
 A = 26, B = 13, C = 77, E = 30  
 Hole size:  
 A = 26.8 x 7, B =  $\varnothing$  6.5,  
 C = 2.3, D = 3.2, E = 3.2

- Flat SMBAMS series bracket for mounting reflectors
- Articulation slots for 90+° rotation
- 14-ga. 300 series stainless steel

Used with:  
 BRT-3  
 BRT-84

BRT-77X77C  
 BRT-51X51BM

**MSMB-MSM-45** (All measurements in mm)

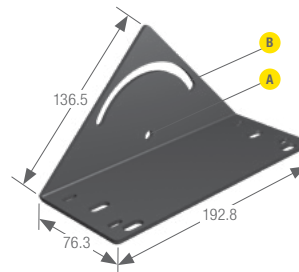

Hole center spacing:  
 A to B = 50.8  
 Hole size:  
 A =  $\varnothing$  7, B = 87.7 x 7

- Bracket for 45° mounting of mirror
- 11-ga. cold-rolled steel with black corrosion-resistant zinc chromate finish
- Bracket hardware included

Used with:  
 MSM4A Mirror

NOTE:  
 For a kit containing a bracket and MSM4A mirror, order model number MSA-MBM-K45

**MSMMB** (All measurements in mm)

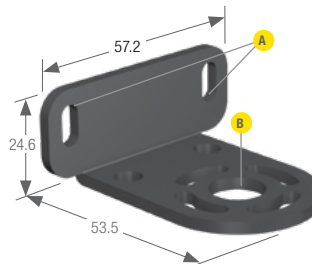

Hole center spacing:  
 A = 44.5  
 Hole size:  
 A = 10.2 x 4.8, B =  $\varnothing$  13.2

- Replacement (pair) for brackets that come with MSM mirrors
- 11-ga. cold-rolled steel with black corrosion-resistant zinc chromate finish
- Bracket hardware included

Used with:  
 MSM Mirror

**LMBWLB92** (All measurements in mm)

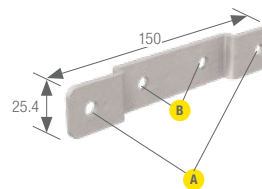

Hole center spacing: B = 45, A = 124.6  
 Hole size: A, B = 4x  $\varnothing$  7.0

- Stainless steel
- Surface mount
- Hardware included

Used with:  
 WLB92

**LMBWLB92-CLIP** (All measurements in mm)

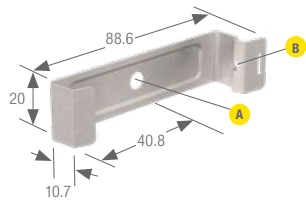

Hole center spacing: n/a  
Hole size: **A** =  $\varnothing 6.5$ , **B** =  $3.6 \times 5.5$

- Stainless steel
- Mounting Clip
- Hardware included

Used with:  
WLB92

**LMBWLB92HKS** (All measurements in mm)



Hole center spacing: **A** = 45  
Hole size: n/a

Hanging kit; 1.5 m (5 ft) cable with looped end  
Galvanized Steel  
Packaged 2 per kit  
Hardware included

Used with:  
WLB92

**LMBWLB92S** (All measurements in mm)

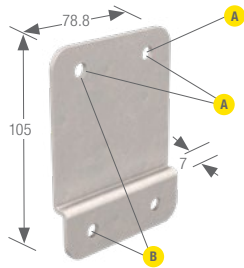

Hole center spacing: **A** = 45, **B** = 80  
Hole size: **A** =  $4 \times \varnothing 7$

Surface Mount; Set of two brackets for end of light  
Stainless Steel  
hardware included

Used with:  
WLB92

**LMBWLB92RAS** (All measurements in mm)

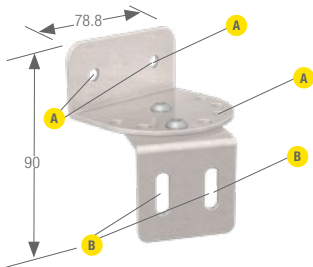

Hole center spacing: **A** = 45, **B** = 25  
Hole size: **A** =  $\varnothing 7$ , **B** =  $7 \times 15$

- Swivel Right Angle Mount; Pair of two swivel right-angle brackets
- Stainless Steel hardware included

Used with:  
WLB92

**SMBQ4XF.** (All measurements in mm)

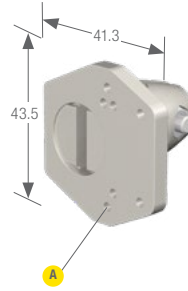

Hole center spacing:  
Hole size:  
**A** =  $7 \times M3 \times 0.5$

Model	Bolt Thread (A)
SMBQ4XFA	3/8 - 16 x 2 1/4"
SMBQ4XFAM10	M10 - 1.5 x 50
SMBQ4XFAM12	n/a; no bolt included. Mounts directly to 12 mm (1/2 in) rods

- 304 stainless steel bracket
- Swivel bracket with tilt and pan movement for precision adjustment
- Clamps on dia. 12mm rod (not included)

Used with:  
Q3X  
Q4X

QS18  
QS30

**LMBWLB32** (All measurements in mm)

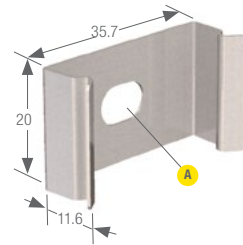

Hole center spacing: n/a  
Hole size: **A** =  $2 \times \varnothing 6.5$

Replaces bracket that ships with the WLB32 light  
Stainless steel  
Includes 4 snap clips, 4 screws, and

Used with:  
WLB32

**LMBWLB32-180S** (All measurements in mm)

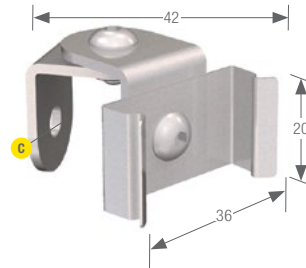

Hole center spacing: n/a  
Hole size: **A** =  $\varnothing 6.4$

- Swivel bracket kit allows 180° of movement
- Stainless steel

Used with:  
WLB32

**LMBLWB32MAG** (All measurements in mm)

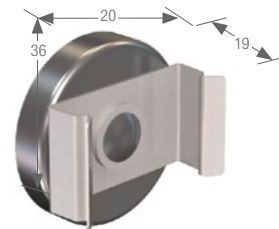

Hole center spacing: n/a  
Hole size: n/a

- Magnet mounting bracket for easy attachment to steel or iron
- Stainless steel

Used with:  
WLB32

**SMBLTFL** (All measurements in mm)

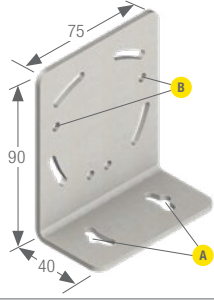

Hole center spacing:  
**A** = 45, **B** = 54.5  
 Hole size:  
**A** = 6x  $\varnothing$  4.5, **B** = 4x  $\varnothing$  4.5

- Right-angle bracket
- 12-ga. stainless steel
- Hardware included

Used with:  
 LTF

**SMBAMSLTFP** (All measurements in mm)

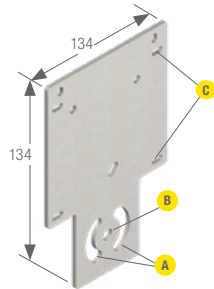

Hole center spacing:  
**C** = 67  
 Hole size:  
**A** = 26.8 x 7, **B** =  $\varnothing$  6.5, **C** = 3.5

- 12-ga. stainless steel
- Articulated slots for 90+° rotation
- Hardware included

Used with:  
 LTF

**SMBLTFU** (All measurements in mm)

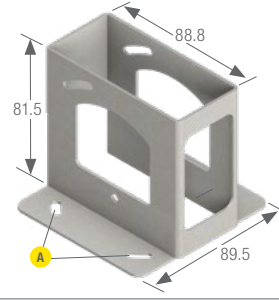

Hole center spacing: **A** = 62.6  
 Hole size: **A** = 8x  $\varnothing$  5.0

- Protective bracket
- 12-ga. stainless steel
- Hardware included

Used with:  
 LTF

**SMBLEU** (All measurements in mm)

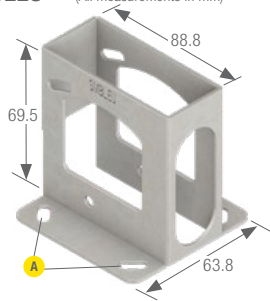

Hole center spacing: **A** = 48  
 Hole size: **A** = 8x  $\varnothing$  2.5

- Protective bracket
- 12-ga. stainless steel
- Hardware included

Used with:  
 LE

**SMBLEL** (All measurements in mm)

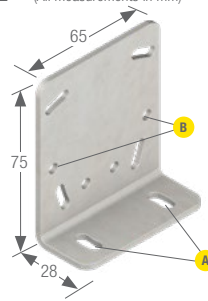

Hole center spacing:  
**A** = 47, **B** = 50.8  
 Hole size:  
**A** = 4x  $\varnothing$  5.7, **B** = 8x  $\varnothing$  4.5

- Right-angle bracket
- 12-ga. stainless steel
- Hardware included

Used with:  
 LE

**SMBVERA** (All measurements in mm)

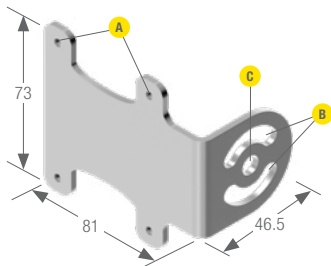

Hole center spacing:  
**A** = 47, **B** = 25  
 Hole size:  
**A** = 4x  $\varnothing$  4.5, **B** = 7 x 26, **C** = 1/4-20

- Right-angle bracket
- 12-ga. stainless steel
- M3 x 0.5 hardware included

Used with:  
 VE

**SMBVEMP** (All measurements in mm)

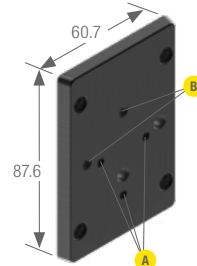

Hole center spacing:  
 Hole size:  
**A** = 3x 10-32 2B THRU  
**B** = M8x 1.25 THRU

- Black ABS plastic
- Hardware included

Used with:  
 VE







## Banner Cordset Selections

---

### M8/Pico-Style

---



3-Pin	page 760
4-Pin	page 762
6-Pin	page 763

### M12/Euro-Style

---



4-Pin	page 764
5-Pin	page 766
8-Pin	page 768
12-Pin	page 775

### M12/Micro-Style

---



3-Pin	page 777
4-Pin	page 777
5-Pin	page 778

### Mini-Style

---



3-Pin	page 779
4-Pin	page 779
5-Pin	page 779
8-Pin	page 780

### Communication

---



Communication	page 781
Ethernet	page 783

### Washdown

---



Washdown	page 784
----------	----------

### Miscellaneous

---

Unterminated Bulk Cable	page 786
Cable Glands	page 786
Field-Wireable Connectors	page 788

3-Pin Threaded M8/Pico-Style

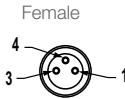
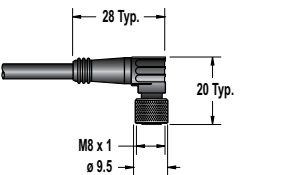
Specifications	Style	Dimensions (mm)	Length	Cable Diameter	Model	Pinout
<b>Cable:</b> PVC jacket, PUR (polyurethane) connector body <b>Coupling Nut:</b> Nickel-plated brass <b>Conductors:</b> 24 AWG, gold-plated contacts <b>Voltage/Current Rating:</b> 125 V ac/dc, 4.0 A <b>Temperature:</b> -40 to +105 °C <b>Environmental Rating:</b> IP67	Straight		2.00 m	4.40 mm	PKG3M-2	Female 
			5.00 m		PKG3M-5	
			7.00 m		PKG3M-7	
			9.00 m		PKG3M-9	
			10.0 m		PKG3M-10	
	Right-Angle		2.00 m	4.40 mm	PKW3M-2	
			5.00 m		PKW3M-5	
			9.00 m		PKW3M-9	

Used with: Q12, T8, SB12, VSM, VS1, VS2, VS3, SLM, IP68 Sealed Ring Light, On-axis Lights

3-Pin Threaded M8/Pico-Style

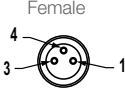
Specifications	Style	Dimensions (mm)	Length	Cable Diameter	Model	Pinout
<b>Cable:</b> PVC jacket and connector body <b>Coupling Nut:</b> Stainless steel <b>Conductors:</b> 24 AWG, gold-plated contacts <b>Voltage/Current Rating:</b> 125 V ac/dc, 4.0 A <b>Temperature:</b> -40 to +90 °C <b>Environmental Rating:</b> IP67	Straight		4.00 m	4.40 mm	PKGV3M-4	Female 
			7.00 m		PKGV3M-7	
			10.0 m		PKGV3M-10	

Used with: IP68 Sealed Ring Lights (stainless steel)

3-Pin Threaded/Snap M8/Pico-Style—Double-Ended

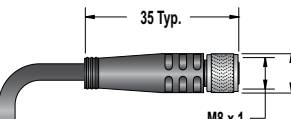
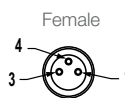
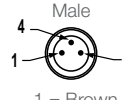
Specifications	Style	Dimensions (mm)	Length	Cable Diameter	Model	Pinout
<b>Cable:</b> PVC jacket, PUR (polyurethane) connector body <b>Coupling Nut:</b> Nickel-plated brass (female) Nylon/nickel-plated brass (male) <b>Conductors:</b> 24 AWG, gold-plated contacts <b>Voltage/Current Rating:</b> 125 V ac/dc, 4.0 A <b>Temperature:</b> -40 to +105 °C <b>Environmental Rating:</b> IP67	Straight		0.35 m	4.40 mm	PKG3M-.35-PSG3M	Female 
			2.00 m		PKG3M-2-PSG3M	Male 

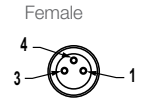
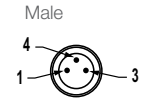
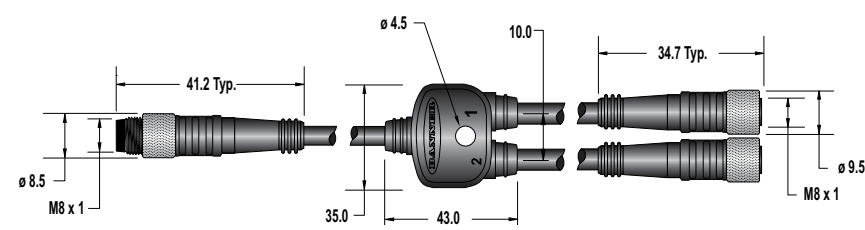

Used with: IP68 Sealed P4 (connect IP68 Sealed Ring Light to P4)

### 3-Pin Threaded M8/Pico-Style Splitter—Flat Junction

Specifications	Branches	Trunk	Cable Diameter	Model	Pinout
<b>Cable:</b> PVC jacket, PUR (polyurethane) connector body <b>Coupling Nut:</b> Nickel-plated brass (female) Nylon/nickel-plated brass (male) <b>Conductors:</b> 24 AWG, gold-plated contacts <b>Voltage/Current Rating:</b> 125 V ac/dc, 4.0 A <b>Temperature:</b> -40 to +105 °C <b>Environmental Rating:</b> IP67 <b>Wiring:</b> Parallel wired Y-cords	3-Pin Pico QD 2 x 0.20 m Female	0.20 m Male	4.40 mm	CSB-M831M831	Female  Male  1 = Brown 3 = Blue 4 = Black
Dimensions (mm) 					

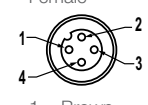

Used with: Connect P4 to two lights, Spot Lights, Area Lights, Backlights

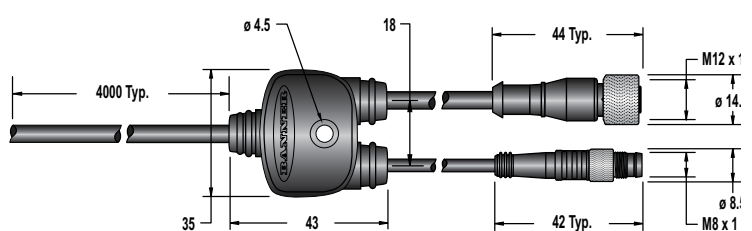
### 3-Pin M8/Pico-Style and 4-Pin M12/Euro-Style to Flying Leads Splitter—Flat Junction

Specifications	Branches	Trunk	Cable Diameter	Model	Pinout
<b>Cable:</b> PVC jacket, PUR (polyurethane) connector body <b>Coupling Nut:</b> Nickel-plated brass <b>Conductors:</b> 24 AWG (3-pin) or 22 AWG (4-pin), gold-plated contacts <b>Voltage/Current Rating:</b> 250 V ac/ 300 V dc, 4.0 A <b>Temperature:</b> -40 to +105 °C <b>Environmental Rating:</b> IP67	3-Pin Pico QD 0.3 m Male 4-pin Euro QD 0.3 m Female	Flying Leads 4 m	4.40 mm (branches) 5.50 mm (trunk)	CSB-UNT213M831F1241	Female  1 = Brown 2 = White 3 = Blue 4 = Black Male  1 = NC 3 = Blue 4 = Black
Dimensions (mm) 					

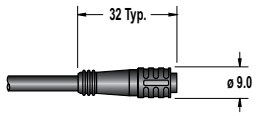

Used with: P4 to High Intensity Area Lights (to strobe from P4)

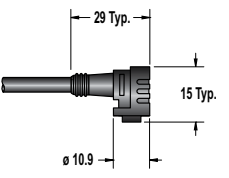
4-Pin Snap-on M8/Pico-Style

Specifications	Style	Dimensions (mm)	Length	Cable Diameter	Model	Pinout
<b>Cable:</b> PVC jacket, PUR (polyurethane) connector body, nylon coupling nut <b>Coupling Nut:</b> Nylon <b>Conductors:</b> 26 AWG, gold-plated contacts <b>Voltage/Current Rating:</b> 125 V ac/dc, 2.0 A <b>Temperature:</b> -40 to +90 °C <b>Environmental Rating:</b> IP67	Straight		2.00 m	3.20 mm	PKG4-2	Female  1 = Brown 2 = White 3 = Blue 4 = Black
	Right-Angle		2.00 m	3.20 mm	PKW4Z-2	

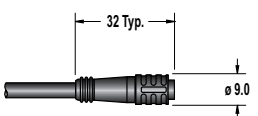

Used with: QS18 (Integral or Pigtail), Q20 (Integral or Pigtail), D12, D10A, DF-G1, S12

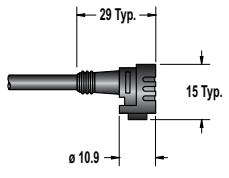
4-Pin Snap-On M8/Pico-Style with Shield

Specifications	Style	Dimensions (mm)	Length	Cable Diameter	Model	Pinout
<b>Cable:</b> PVC jacket, PUR (polyurethane) connector body, nylon or PUR coupling nut <b>Coupling Nut:</b> Nylon or PUR <b>Conductors:</b> 26 AWG (shielded), gold-plated contacts <b>Voltage/Current Rating:</b> 125 V ac/dc, 2.0 A <b>Temperature:</b> -40 to +90 °C <b>Environmental Rating:</b> IP67	Straight		2.00 m	4.40 mm	PKG4S-2	Female  1 = Brown 2 = White 3 = Blue 4 = Black
	Right-Angle		2.00 m	4.40 mm	PKW4ZS-2	

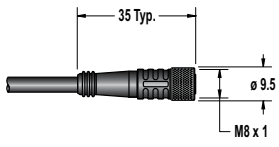

Used with: QS18U

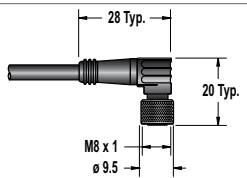
4-Pin Threaded M8/Pico-Style

Specifications	Style	Dimensions (mm)	Length	Cable Diameter	Model	Pinout
<b>Cable:</b> PVC jacket, PUR (polyurethane) body <b>Coupling Nut:</b> Nickel-plated brass <b>Conductors:</b> 26 AWG, gold-plated contacts <b>Voltage/Current Rating:</b> 125 V ac/dc, 2.0 A <b>Temperature:</b> -40 to +105 °C <b>Environmental Rating:</b> IP67	Straight		2.00 m	3.80 mm	PKG4M-2	Female  1 = Brown 2 = White 3 = Blue 4 = Black
			5.00 m		PKG4M-5	
			9.00 m		PKG4M-9	
	Right-Angle		2.00 m	4.30	PKW4M-2	
			5.00 m		PKW4M-5	
			9.00 m		PKW4M-9	

Used with: Q12, QS18 (Pigtail), Q20 (Pigtail), S12, QMH26, Q26, D12, DF-G1

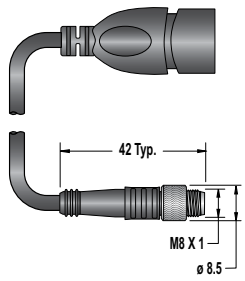
4-Pin Threaded M8/Pico-Style to USB with Shield—Double-Ended

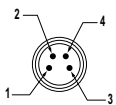
Specifications	Style	Dimensions (mm)	Length	Cable Diameter	Model	Pinout
<b>Cable:</b> PVC jacket, PUR (polyurethane) connector body <b>Coupling Nut:</b> Nickel-plated brass on Pico QD end <b>Conductors:</b> 28 AWG and 24 AWG, gold-plated contacts <b>Voltage/Current Rating:</b> 60V ac/75V dc, 2.0 A <b>Temperature:</b> -40 to +105 °C <b>Environmental Rating:</b> IP67	Straight Pico QD/USB		0.15 m	4.80 mm	PSG-4M-4005-USB	USB  1 = Red    3 = Green 2 = White   4 = Black  Male  1 = Red    3 = Black 2 = White   4 = Green
			0.30 m		PSG-4M-401-USB	
			0.91 m		PSG-4M-403-USB	
			3.05 m		PSG-4M-410-USB	
			4.88 m		PSG-4M-416-USB	

Used with: iVu TG & BCR — Remote Touch Screen models, iVu Plus

6-Pin Snap-On M8/Pico-Style

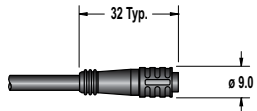
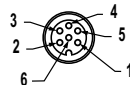
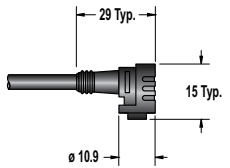
Specifications	Style	Dimensions (mm)	Length	Cable Diameter	Model	Pinout
<b>Cable:</b> PVC jacket, PUR (polyurethane) connector body <b>Coupling Nut:</b> Nylon or PUR <b>Conductors:</b> 26 AWG (shielded), gold-plated contacts <b>Voltage/Current Rating:</b> 125V ac/dc, 2.0 A <b>Temperature:</b> -40 to +90 °C <b>Environmental Rating:</b> IP67	Straight		2.00 m	4.70 mm	PKG6Z-2	Female  1 = Brown 2 = White 3 = Blue 4 = Black 5 = Gray 6 = Pink
			9.00 m		PKG6Z-9	
	Right-Angle		2.00 m	4.70 mm	PKW6Z-2	
			9.00 m		PKW6Z-9	

Used with: D10

4-Pin Threaded M12/Euro-Style

Specifications	Style	Dimensions (mm)	Length	Cable Diameter	Model	Pinout
<b>Cable:</b> PVC jacket, PUR (polyurethane) connector body <b>Coupling Nut:</b> Nickel-plated brass <b>Conductors:</b> 22 AWG, gold-plated contacts <b>Voltage/Current Rating:</b> 250V ac/dc, 4.0 A <b>Temperature:</b> -40 to +105 °C <b>Environmental Rating:</b> IP67/IP69K	Straight		1.83 m	5.20 mm	MQDC-406	Female  1 = Brown 2 = White 3 = Blue 4 = Black
			4.57 m		MQDC-415	
			9.14 m		MQDC-430	
			15.2 m		MQDC-450	
	Right-Angle		2.00 m	5.20 mm	MQDC-406RA-2	
			5.00 m		MQDC-415RA	
			9.00 m		MQDC-430RA	
					MQDC-450RA	

Used with: Q12, M12, QS18, Q20, OMNI-BEAM (QDH suffix), Q45 dc sensors (Q5 suffix), MINI-BEAM dc, SM312 sensors, S18, M18, T18, Q25, S30, T30, Q40, TM18/TM18 Expert, QM42/QMT42, QL50/QL51, SLM, R58A, T18U, TL50/TL30F, K5, K80, PVA/PVL, VTB, STB with solid-state relay, EZ-LIGHT, WL50, WLS28-2, QM26, Q26, DF-G1, WLA, WLC60, WLC90, E-Stops w/ Q4 suffix

4-Pin Threaded M12/Euro-Style with Shield

Specifications	Style	Dimensions (mm)	Length	Cable Diameter	Model	Pinout
<b>Cable:</b> PVC jacket, PUR (polyurethane) connector body, nickel-plated <b>Coupling Nut:</b> Nickel-plated brass <b>Conductors:</b> 22 AWG (shielded), gold-plated contacts <b>Voltage/Current Rating:</b> 250 V ac/dc, 4.0 A <b>Temperature:</b> -40 to +105 °C <b>Environmental Rating:</b> IP67	Straight		1.83 m	5.20 mm	MQDEC2-406	Female  1 = Brown 2 = White 3 = Blue 4 = Black
			4.57 m		MQDEC2-415	
			9.14 m		MQDEC2-430	
	Right-Angle		1.83 m	5.20 mm	MQDEC2-406RA	
			4.57 m		MQDEC2-415RA	
			9.14 m		MQDEC2-430RA	

Used with: QS18U, T30UX

4-Pin Threaded M12/Euro-Style (for use with NAMUR sensors)

Specifications	Style	Dimensions (mm)	Length	Cable Diameter	Model	Pinout
<b>Cable:</b> PVC jacket, PUR (polyurethane) connector body <b>Coupling Nut:</b> Nickel-plated brass <b>Conductors:</b> 20 AWG, gold-plated contacts <b>Voltage/Current Rating:</b> 250 V ac/dc, 4.0 A <b>Temperature:</b> -40 to +105 °C <b>Environmental Rating:</b> IP67	Straight		1.83 m	5.20 mm	MQD9-406	Female  1 = Brown 2 = Blue
			4.57 m		MQD9-415	
			9.14 m		MQD9-430	
	Right-Angle		1.83 m	5.20 mm	MQD9-406RA	
			4.57 m		MQD9-415RA	
			9.14 m		MQD9-430RA	

Used with: MINI-BEAM & Q45 NAMUR sensors

4-Pin Threaded M12/Euro-Style—Double-Ended

Specifications	Style	Dimensions (mm)	Length	Cable Diameter	Model	Pinout
<b>Cable:</b> PVC jacket, PUR (polyurethane) connector body <b>Coupling Nut:</b> Nickel-plated brass <b>Conductors:</b> 22 AWG, gold-plated contacts <b>Voltage/Current Rating:</b> 250 V ac/dc, 4.0 A <b>Temperature:</b> -40 to +105 °C <b>Environmental Rating:</b> IP67	Straight		0.31 m	5.90 mm	MQDEC-401SS	Female  Male  1 = Brown 2 = White 3 = Blue 4 = Black
			0.91 m		MQDEC-403SS	
			1.83 m		MQDEC-406SS	
			3.66 m		MQDEC-412SS	
			6.10 m		MQDEC-420SS	
			9.14 m		MQDEC-430SS	
			15.2 m		MQDEC-450SS	
	Right-Angle		0.91 m	5.90 mm	MQDEC-403RS	
			1.83 m		MQDEC-406RS	
			3.66 m		MQDEC-412RS	
			6.10 m		MQDEC-420RS	
			9.14 m		MQDEC-430RS	
			15.2 m		MQDEC-450RS	



Used with: M12, QS18, Q20, OMNI-BEAM (QDH suffix), Q45 dc sensors (Q5 suffix), MINI-BEAM dc, SM312 sensors, S18, M18, T18, Q25, S30, T30, Q40, QM42/QMT42, SLM, R58A, T18U, TL50, TL30F, K50, K80, PVA/PVL, VTB and STB, EZ-LIGHT, WL50, WLS28-2, QM26, Q26, DF-G1, WLA, WLC60/WLC90, QL50

4-Pin Threaded M12/Euro-Style Splitter—Flat Junction

Specifications	Branches(Female)	Trunk(Male)	Cable Diameter	Model	Pinout	
<b>Cable:</b> PVC jacket, PUR (polyurethane) connector body <b>Coupling Nut:</b> Nickel-plated brass <b>Conductors:</b> 22 AWG, gold-plated contacts <b>Voltage/Current Rating:</b> 250 V ac/300 V dc, 4.0A <b>Temperature:</b> -40 to +105 °C <b>Environmental Rating:</b> IP67 <b>Wiring:</b> Parallel wired Y-cord	No branch	No trunk	5.50 mm	CSB-M1240M1240	Female  Male  1 = Brown 2 = White 3 = Blue 4 = Black	
	2 x 0.30 m	No trunk				CSB-M1240M1241
		0.30 m				CSB-M1241M1241
		2.50 m				CSB-M1248M1241
		4.60 m				CSB-M12415M1241
		7.60 m				CSB-M12425M1241
		7.60 m Unterminated				CSB-UNT425M1241
	<b>Dimensions (mm)</b>					

Used with: Sensors w/4-Pin Euro QD, EZ-LIGHT, DX80 (10 to 30 V dc), DX85, WLS28-2, WL50, WLA, WLC60, WLC90

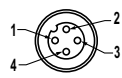
4-Pin Threaded M12/Euro-Style Splitter—Rounded Junction

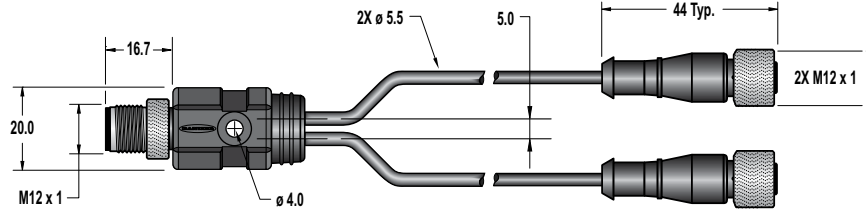
Specifications	Branches(Female)	Trunk(Male)	Cable Diameter	Model	Pinout
<b>Cable:</b> PVC jacket, PUR (polyurethane) connector body <b>Coupling Nut:</b> nNickel-plated brass <b>Conductors:</b> 22 AWG, gold-plated contacts <b>Voltage/Current Rating:</b> 60 V ac/75 V dc, 2.0A <b>Temperature:</b> -40 to +105 °C <b>Environmental Rating:</b> IP67 <b>Wiring:</b> Parallel wired Y-cord	0.31 m	No trunk	5.50 mm	CSRB-M1240M1241	Female  Male  1 = Brown 2 = White 3 = Blue 4 = Black
	0.61 m			CSRB-M1240M1242	
	0.91 m			CSRB-M1240M1243	
	1.22 m			CSRB-M1240M1244	
<b>Dimensions (mm)</b>					
					

Used with: Sensors w/4-Pin Euro QD, EZ-LIGHT, DX80 (10 to 30 V dc), DX85, WLS28-2, WL50, WLA, WLC60, WLC90

Specifications

5-Pin Threaded M12/Euro-Style

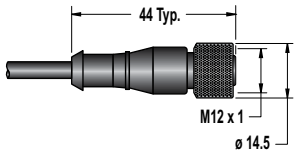
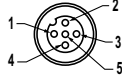
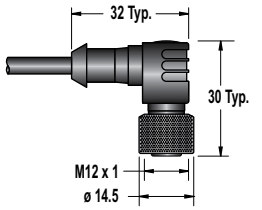
Specifications	Style	Dimensions (mm)	Length	Cable Diameter	Model	Pinout
<b>Cable:</b> PVC jacket, PUR (polyurethane) connector body <b>Coupling Nut:</b> Nickel-plated brass <b>Conductors:</b> 22 AWG, gold-plated contacts <b>Voltage/Current Rating:</b> 250 V ac/dc, 4.0 A <b>Temperature:</b> -40 to +105 °C <b>Environmental Rating:</b> IP67	Straight		0.50 m	5.20 mm	MQDC1-501.5	Female  1 = Brown 2 = White 3 = Blue 4 = Black 5 = Gray
			1.83 m		MQDC1-506	
			4.57 m		MQDC1-515	
			9.14 m		MQDC1-530	
	Right-Angle		1.83 m	5.20 mm	MQDC1-506RA	
			4.57 m		MQDC1-515RA	
9.14 m	MQDC1-530RA					

Used with: MINI-BEAM Expert, QS30, PicoDot, Q45 Laser Retro, R55F, SL30 & SL30E, SL10 & SL10E, VTB (2-color), QL56, Q60, PVD, STB, K50, K80, DX80, DX81, DX85, EZ-LIGHT, STB w/em relay, High-Intensity Area Lights, High-Intensity Ring Lights, Sealed Backlights, R58 Expert, QL56

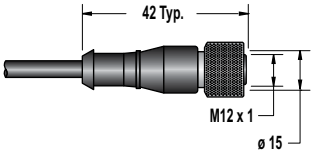
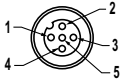

5-Pin Threaded M12/Euro-Style

Cordset Specs	Style	Dimensions (mm)	Length	Cable Diameter	Model	Pinout
<b>Cable:</b> PVC jacket, PUR (polyurethane) connector body <b>Coupling Nut:</b> Nickel-plated brass <b>Conductors:</b> 20 AWG, gold-plated contacts <b>Voltage/Current Rating:</b>  250 V ac/dc, 4.0 A <b>Temperature:</b> -40 to +105 °C <b>Environmental Rating:</b> IP67	Straight		1.83 m	6.00 mm	MQDC20-506	Female  1 = Brown 2 = White 3 = Blue 4 = Black 5 = Gray
			4.57 m		MQDC20-515	
			9.14 m		MQDC20-530	

Used with: High Intensity Area Lights, High Intensity Ring Lights, Sealed Linear Array Lights, Sealed Backlights **NOTE:** Except stainless steel models

5-Pin Threaded M12/Euro-Style

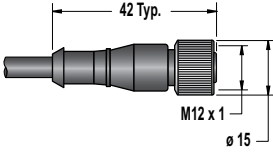
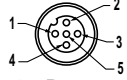
Specifications	Style	Dimensions (mm)	Length	Cable Diameter	Model	Pinout
<b>Cable:</b> PVC jacket, PUR (polyurethane) connector body <b>Coupling Nut:</b> 316 stainless steel <b>Conductors:</b> 20 AWG, gold-plated contacts <b>Voltage/Current Rating:</b> 250 V ac/dc, 4.0 A <b>Temperature:</b> -40 to +105 °C <b>Environmental Rating:</b> IP67	Straight		1.83 m	6.00 mm	MQDC20SS-506	Female  1 = Brown 2 = White 3 = Blue 4 = Black 5 = Gray
			4.57 m		MQDC20SS-515	
			9.14 m		MQDC20SS-530	

Used with: M25U, QM26

5-Pin Threaded M12/Euro-Style with Shield

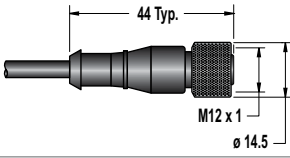
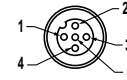
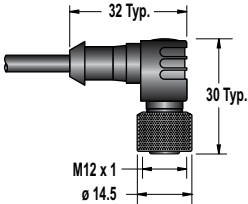
Specifications	Style	Dimensions (mm)	Length	Cable Diameter	Model	Pinout
<b>Cable:</b> PVC jacket, PUR (polyurethane) connector body <b>Coupling Nut:</b> nickel-plated brass <b>Conductors:</b> 22 AWG (shielded), gold plated contacts <b>Voltage/Current Rating:</b> 250 V ac/dc, 4.0 A <b>Temperature:</b> -40 to +105 °C <b>Environmental Rating:</b> IP67	Straight		1.83 m	5.60 mm	MQDEC2-506	Female  1 = Brown 2 = White 3 = Blue 4 = Black 5 = Gray
			4.57 m		MQDEC2-515	
			9.14 m		MQDEC2-530	
			15.2 m		MQDEC2-550	
	Right-Angle		1.83 m	5.60 mm	MQDEC2-506RA	
			4.57 m		MQDEC2-515RA	
			9.14 m		MQDEC2-530RA	
			15.2 m		MQDEC2-550RA	

Used with: R58E, QT50U dc sensors, S18U, T30U, M25U, Q45U, Q45UR, LX, QT50R, Q120RA

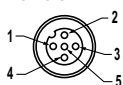
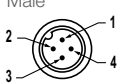
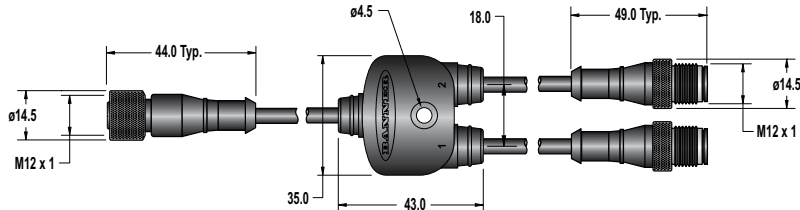
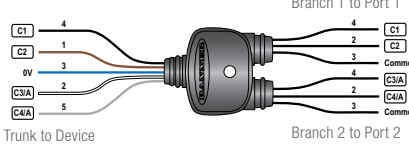

5-Pin Threaded M12/Euro-Style to 4-Pin Threaded M12/Euro Style Splitter—Flat Junction

Specifications	Branches(Male)	Trunk(Female)	Cable Diameter	Model	Pinout	
<b>Cable:</b> PVC jacket, PUR (polyurethane) connector body <b>Coupling Nut:</b> Nickel-plated brass <b>Conductor:</b> 22 AWG, gold-plated contacts <b>Voltage/Current Rating:</b> 250 V ac/ 300 V dc, 4.0 A <b>Temperature:</b> -40 to +105 °C <b>Environmental Rating:</b> IP67 <b>Wiring:</b> Combiner Y-cord	4-pin Euro QD 2 x 0.31 m	5-pin Euro QD 0.31 m	5.50 mm	CSF-M12F51M12M41	Female  Male 	
<b>Dimensions (mm)</b>						
						
	<b>Branch 1</b> 1 = NC 2 = Brown 3 = Blue 4 = Black	<b>Branch 2</b> 1 = NC 2 = Gray 3 = Blue 4 = White	<b>Trunk</b> 1 = Brown 2 = White 3 = Blue 4 = Black 5 = Gray			

Used with: 3- or 4-Segmented EZ-LIGHT, 3- or 4-function TL50 Tower Lights

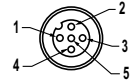

NOTE: Use to connect device to a "2-output" I/O block

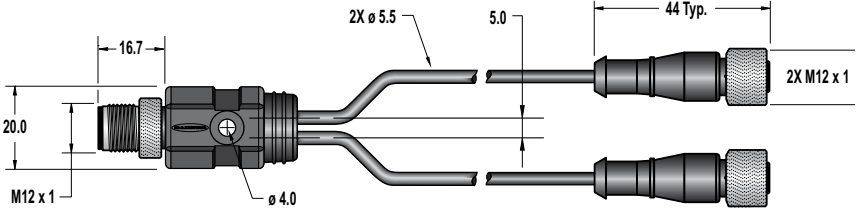
5-Pin Threaded M12/Euro-Style Splitter—Rounded Junction

Specifications	Branches(Female)	Trunk(Male)	Cable Diameter	Model	Pinout	
<b>Cable:</b> PVC jacket, PUR (polyurethane) connector body <b>Coupling Nut:</b> Nickel-plated brass <b>Conductor:</b> 22 AWG, gold-plated contacts <b>Voltage/Current Rating:</b> 60 V ac/ 75 V dc, 2.0 A <b>Temperature:</b> -40 to +105 °C <b>Environmental Rating:</b> IP67 <b>Wiring:</b> Parallel wired Y-cord	<b>Branch 1</b> 0.14 m <b>Branch 2</b> 0.22 m	No trunk	5.60 mm	CSRB-M1250M125.47M125.73	Female  Male  1 = Brown 2 = White 3 = Blue 4 = Black 5 = Green/Yellow	
<b>Dimensions (mm)</b>						
						

Used with: EZ-LIGHTS w/5-Pin Euro QD, DX80 (FlexPower), LX

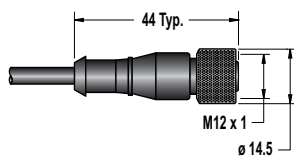
8-Pin Threaded M12/Euro-Style with Shield

Specifications	Style	Dimensions (mm)	Length	Cable Diameter	Model	Pinout
<b>Cable:</b> PVC jacket, PUR (polyurethane) connector body <b>Coupling Nut:</b> Nickel-plated brass <b>Conductors:</b> 24 AWG (shielded), gold-plated contacts <b>Voltage/Current Rating:</b> 75 V ac/dc, 2.0 A <b>Temperature:</b> -40 to +105 °C <b>Environmental Rating:</b> IP67	Straight		1.83 m	5.60 mm	MQDC-806	Female  1 = White 5 = Gray 2 = Brown 6 = Pink 3 = Green 7 = Blue 4 = Yellow 8 = Shield
4.58 m			MQDC-815			
9.14 m			MQDC-830			

Used with: LT3, LG5, LG10

8-Pin Threaded M12/Euro-Style with Shield

Specifications	Style	Dimensions (mm)	Length	Cable Diameter	Model	Pinout
<b>Cable:</b> PVC jacket, PUR (polyurethane) connector body <b>Coupling Nut:</b> Nickel-plated brass <b>Conductors:</b> 24 AWG (shielded), gold-plated contacts <b>Voltage/Current Rating:</b> 75 V ac/dc, 2.0 A <b>Temperature:</b> -40 to +105 °C <b>Environmental Rating:</b> IP67	Straight		1.83 m	5.60 mm	MAQDC-806	Female  1 = White 5 = Gray 2 = Brown 6 = Pink 3 = Green 7 = Blue 4 = Yellow 8 = Red
			4.58 m		MAQDC-815	
			9.14 m		MAQDC-830	
			15.2 m		MAQDC-850	
<b>Used with:</b> EZ-ARRAY, Emitters/Receivers						

8-Pin Threaded M12/Euro-Style with Shield

Specifications	Style	Dimensions (mm)	Length	Cable Diameter	Model	Pinout
<b>Cable:</b> PVC jacket, PUR (polyurethane) connector body <b>Coupling Nut:</b> Nickel-plated brass <b>Conductors:</b> 24 AWG (shielded), gold-plated contacts <b>Voltage/Current Rating:</b> 75 V ac/dc, 2.0 A <b>Temperature:</b> -40 to +105 °C <b>Environmental Rating:</b> IP67	Straight		1.83 m	6.00 mm	MQLH-806-F	Female  1 = White 5 = Gray 2 = Brown 6 = Green 3 = Shield 7 = Blue 4 = Yellow 8 = Shield
			4.58 m		MQLH-815-F	
			9.14 m		MQLH-830-F	
<b>Used with:</b> LH						

8-Pin Threaded M12/Euro-Style with Open-Shield

Specifications	Style	Dimensions (mm)	Length	Cable Diameter	Model	Pinout
<b>Cable:</b> PVC jacket, PUR (polyurethane) connector body <b>Coupling Nut:</b> Nickel-plated brass <b>Conductors:</b> 24 AWG (shielded), gold-plated contacts <b>Voltage/Current Rating:</b> 75 V ac/dc, 2.0 A <b>Temperature:</b> -40 to +105 °C <b>Environmental Rating:</b> IP67	Straight		1.83 m	5.60 mm	MQDC2S-806	Female  1 = White 2 = Brown 3 = Green 4 = Yellow 5 = Gray 6 = Pink 7 = Blue 8 = Red
			4.57 m		MQDC2S-815	
			9.14 m		MQDC2S-830	
			15.2 m		MQDC2S-850	
	Right-Angle		1.83 m	5.60 mm	MQDC2S-806RA	1 = White 2 = Brown 3 = Green 4 = Yellow 5 = Gray 6 = Pink 7 = Blue 8 = Red
			4.57 m		MQDC2S-815RA	
			9.14 m		MQDC2S-830RA	
			15.2 m		MQDC2S-850RA	
<b>Used with:</b> QC50, QCX50, EZ-LIGHT, iVu TG—Integrated Touch Screen models, E-Stops w/Q8 suffix						

8-Pin Threaded M12/Euro-Style

Specifications	Style	Dimensions (mm)	Length	Cable Diameter	Model	Pinout
<b>Cable:</b> PVC jacket, PUR (polyurethane) connector body <b>Coupling Nut:</b> Nickel-plated brass <b>Conductors:</b> 22 AWG, gold-plated contacts <b>Voltage/Current Rating:</b> 75 V ac/dc, 2.0 A <b>Temperature:</b> -40 to +105 °C <b>Environmental Rating:</b> IP67	Straight		4.57 m	6.00 mm	QDE-815D	Female  1 = Brown 5 = Black 2 = Or/Bl 6 = Blue 3 = Orange 7 = Gn/Ye 4 = White 8 = Violet
			7.62 m		QDE-825D	
			15.3 m		QDE-850D	
			22.9 m		QDE-875D	
			30.5 m		QDE-8100D	
<b>Used with:</b> EZ-SCREEN w/8-pin QD (14 & 30 mm Resolution), EZ-SCREEN LP w/8-pin QD, (14 & 25 mm Resolution), EZ-SCREEN w/8-pin QD (Point & Grid), EZ-SCREEN Type 2						

8-Pin Threaded M12/Euro-Style Cordsets

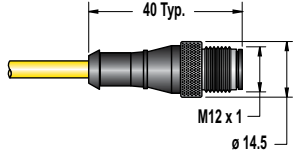
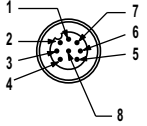
Specifications	Style	Dimensions (mm)	Length	Cable Diameter	Model	Pinout
<b>Cable:</b> PVC jacket, PUR (polyurethane) connector body <b>Coupling Nut:</b> Nickel-plated brass <b>Conductors:</b> 22 AWG, gold-plated contacts <b>Voltage/Current Rating:</b> 60 V ac 75 V dc, 2.0 A <b>Temperature:</b> -40 to +105 °C <b>Environmental Rating:</b> IP67	Straight		4.57 m	5.50 mm	QDE2R4-815D	Male  1 = Brown      5 = Blue 2 = Not Used    6 = Not Used 3 = Not Used    7 = Not Used 4 = Black        8 = White
			7.62 m		QDE2R4-825D	
			15.2 m		QDE2R4-850D	

Used with: EZ-SCREEN Receiver (Cascade) CSSI QD (14 & 30 mm), EZ-SCREEN LP Receiver (Cascade) CSSI QD and a DELPEF-810 (14 & 25 mm)

NOTE: For connection of E-Stop or other hard/relay contacts.

8-Pin Threaded M12/Euro-Style with Shield—Double-Ended

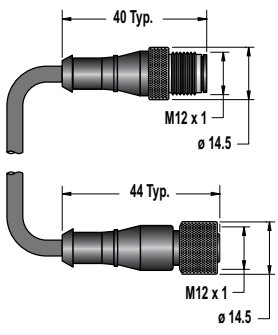
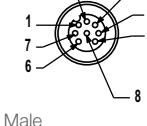
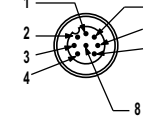
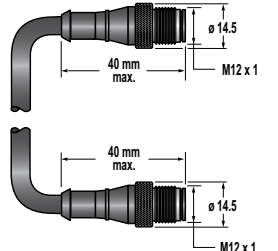
Specifications	Style	Dimensions (mm)	Length	Cable Diameter	Model	Pinout
<b>Cable:</b> PVC jacket, PUR (polyurethane) connector body <b>Coupling Nut:</b> Nickel-plated brass <b>Conductors:</b> 24 AWG (shielded), gold-plated contacts <b>Voltage/Current Rating:</b> 60 V ac/ 75 V dc, 2.0 A <b>Temperature:</b> -40 to +105 °C <b>Environmental Rating:</b> IP67	Male Straight/ Female Straight		1.83 m	6.00 mm	MQLH-806-MF	Female  Male  1 = White      5 = Gray 2 = Brown     6 = Green 3 = Shield     7 = Blue 4 = Yellow     8 = Shield
			4.57 m		MQLH-815-MF	
			9.14 m		MQLH-830-MF	
	Male Straight/ Male Straight		0.30 m	6.00 mm	MQLH-801-MM	

Used with: LH

8-Pin Threaded M12/Euro-Style—Double-Ended

Specifications	Style	Dimensions (mm)	Length	Cable Diameter	Model*	Pinout		
<b>Cable:</b> PVC jacket, PUR (polyurethane) connector body <b>Coupling Nut:</b> Nickel-plated brass <b>Conductors:</b> 22 AWG, gold-plated contacts <b>Voltage/Current Rating:</b> 60 V ac/75 V dc, 2.0 A <b>Temperature:</b> -40 to +105 °C <b>Environmental Rating:</b> IP68	Female Straight/ Male Straight		0.31 m	6.00 mm	8-pin/8-pin	8-Pin Female to 5-Pin Male 1 ↔ 1 2 ↔ 2 3 ↔ 3 4 ↔ 4 5 ↔ 5 6 ↔ 6 7 ↔ 7 8 ↔ 8		
			0.91 m		DEE2R-81D		DEE8-41D	
			2.44 m		DEE2R-83D		—	DEE8-58D
			4.57 m		DEE2R-88D		DEE8-48D	DEE8-515D
			7.62 m		DEE2R-815D		DEE8-48D	DEE8-515D
			15.2 m		DEE2R-825D		DEE8-425D	DEE8-525D
			22.9 m		DEE2R-850D		—	—
			30.5 m		DEE2R-875D		—	—
					DEE2R-8100D		—	—

Used with: EZ-SCREEN w/8-pin QD (14 & 30 mm Resolution), EZ-SCREEN LP w/8-pin QD, (14 & 25 mm Resolution), EZ-SCREEN w/8-pin QD, (Point & Grid), EZ-SCREEN Type 2 (DEE2R only), AC Interface Boxes (DEE2R only), E-Stops 8-pin QD w/Q8 suffix

8-Pin Threaded M12/Euro-Style Splitter with Shield—Flat Junction

Specifications	Branches(Female)	Trunk(Male)	Cable Diameter	Model	Pinout
<b>Cable:</b> PVC jacket, PUR (polyurethane) connector body <b>Coupling Nut:</b> nickel-plated brass <b>Conductors:</b> 24 AWG (shielded), gold-plated contacts <b>Voltage/Current Rating:</b> 60 V ac/75 V dc, 2.0 A <b>Temperature:</b> -40 to +80 °C <b>Environmental Rating:</b> IP67 <b>Wiring:</b> Parallel wired Y-cord	No branches	No trunk	6.00 mm	CSB-M1280M1280-LH	Female  Male  1 = White 5 = Gray 2 = Brown 6 = Green 3 = Shield 7 = Blue 4 = Yellow 8 = Shield
	0.60 m	0.30 m		CSB-M1281M1282-LH	
	<b>Dimensions (mm)</b> 				

Used with: LH

8-Pin Threaded M12/Euro-Style Splitter with Shield—Flat Junction

Specifications	Branches(Female)	Trunk(Male)	Cable Diameter	Model	Pinout	
<b>Cable:</b> PVC jacket, PUR (polyurethane) connector body <b>Coupling Nut:</b> nickel-plated brass <b>Conductors:</b> 24 AWG (shielded), gold-plated contacts <b>Voltage/Current Rating:</b> 60 V ac/75 V dc, 2.0 A <b>Temperature:</b> -40 to +80 °C <b>Environmental Rating:</b> IP67 <b>Wiring:</b> Parallel wired Y-cord	0.60 m	0.30 m	6.00 mm	CSB3-M1281M1282-LH	Female  Male  1 = White 5 = Gray 2 = Brown 6 = Green 3 = Shield 7 = Blue 4 = Yellow 8 = Shield	
	<b>Dimensions (mm)</b> 					

Used with: LH

\* Standard cordsets are yellow PVC with black overmold. For black PVC and overmold, add suffix **B** to model number (example, DEE2R-81DB)  
 \*\* For connection to safety BUS gateway/node, a "smart" self-monitored safety module, safety controller or safety PLC.  
 † DEE8-4..D do not have the pin 5 GND/chassis connection. GND/chassis connection should be made via the mounting hardware.

8-Pin Threaded M12/Euro-Style Splitter Cordsets—Flat Junction

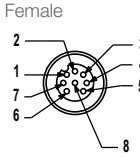
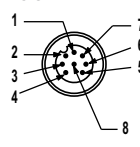
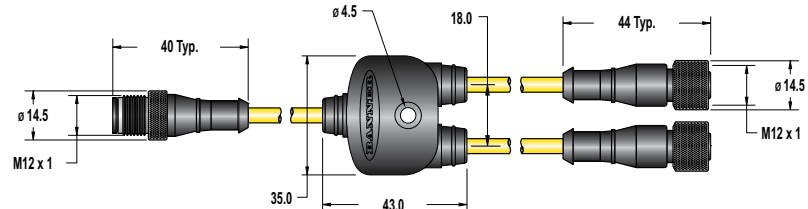

Specifications	Branches(Female)	Trunk(Male)	Cable Diameter	Model	Pinout
<b>Cable:</b> PVC jacket, PUR (polyurethane) connector body <b>Coupling Nut:</b> nickel-plated brass <b>Conductors:</b> 22 AWG, gold-plated contacts <b>Voltage/Current Rating:</b> 60 V ac/75 V dc, 2.0 A <b>Temperature:</b> -40 to +105 °C <b>Environmental Rating:</b> IP68 <b>Wiring:</b> Parallel wired Y-cord	No branches	No trunk	6.00 mm	CSB-M1280M1280	Female  Male  1 = Brown 5 = Black 2 = Or/Bk 6 = Blue 3 = Orange 7 = Gn/Ye 4 = White 8 = Violet
	2 x 0.3 m	0.3 m		CSB-M1281M1281	
		2.5 m		CSB-M1288M1281	
		4.6 m		CSB-M12815M1281	
		7.6 m		CSB-M12825M1281	
		7.6 m Unterminated		CSB-UNT825M1281*	
<b>Dimensions (mm)</b>					
					

Used with: EZ-ARRAY, EZ-LIGHT Indicator Lights, EZ-SCREEN w/8-pin QD (14 & 30 mm Resolution), EZ-SCREEN LP w/8-pin QD (14 & 25 mm Resolution), EZ-SCREEN w/8-pin QD (Point & Grid), EZ-SCREEN Type 2, AC Interface Boxes

\* Unterminated cordset is not compatible with the EZ-ARRAY

NOTE: Standard cordsets are yellow PVC with black overmold. For black PVC and overmold, add suffix B to model number (example, CSB-M1280M1280B).

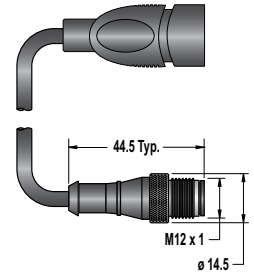
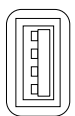
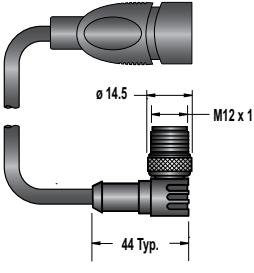
8-Pin Threaded M12/Euro-Style to USB—Double Ended

Specifications	Style	Dimensions (mm)	Length	Cable Diameter	Model	Pinout
<b>Cable:</b> PVC jacket, PUR (polyurethane) connector body <b>Coupling Nut:</b> Nickel-plated brass on Euro QD end <b>Conductors:</b> 28 AWG or 24 AWG, gold-plated contacts <b>Voltage Rating:</b> 60 V ac/75 V dc <b>Temperature:</b> -40 to +90 °C	Straight Euro QD/USB		0.15 m	4.80 mm	MQDEC-8005-USB	USB 
			0.30 m		MQDEC-801-USB	
			0.90 m		MQDEC-803-USB	
			3.00 m		MQDEC-810-USB	
	Right-Angle Euro QD/USB		0.15 m	4.80 mm	MQDEC-8005RA-USB	Male 
			0.30 m		MQDEC-801RA-USB	
			0.90 m		MQDEC-803RA-USB	
			3.00 m		MQDEC-810RA-USB	

Used with: iVu TG & BCR— Integrated Touch Screen models

8-Pin Threaded M12/Euro-Style to Molex—Double Ended

Specifications	Style	Dimensions (mm)	Length	Cable Diameter	Model	Pinout
<b>Cable:</b> Euro, PVC jacket, PUR (polyurethane) connector body <b>Coupling Nut:</b> Nickel-plated brass <b>Molex:</b> Nylon (polyamide)/PUR (polyurethane) <b>Conductors:</b> 24 AWG, gold-plated contacts <b>Voltage Rating:</b> 30 V ac/dc 2.0 A <b>Temperature:</b> -40 to +105 °C <b>Environmental Rating:</b> IP67	Straight Euro QD/ Molex		0.91 m	6.10 mm	IVURD-MX-803	Molex   Male  1 = Orange 5 = Green 2 = Brown 6 = Blue 3 = Wh/Bn 7 = Wh/Or 4 = Wh/Bl 8 = Wh/Gn
			1.83 m		IVURD-MX-806	
			4.57 m		IVURD-MX-815	
			9.14 m		IVURD-MX-830	
			15.2 m		IVURD-MX-850	
	Right-Angle Euro QD/ Molex		0.91 m	6.10 mm	IVURD-MX-803RA	
			1.83 m		IVURD-MX-806RA	
			4.57 m		IVURD-MX-815RA	
			9.14 m		IVURD-MX-830RA	
			15.2 m		IVURD-MX-850RA	

Used with: iVu RD35 remote display

8-Pin Threaded M12/Euro-Style—Double-Ended

Specifications	Style	Dimensions (mm)	Length	Cable Diameter	Model	Pinout
<b>Cable:</b> Euro, PVC jacket, PUR (polyurethane) connector body <b>Molex:</b> Nylon (polyamide)/PUR (polyurethane) <b>Coupling Nut:</b> Nickel-plated brass <b>Conductors:</b> 24 AWG, gold-plated contacts <b>Voltage Rating:</b> 30 V ac/dc 2.0 A <b>Temperature:</b> -40 to +105 °C <b>Environmental Rating:</b> IP67	Straight Euro QD/ Straight Euro QD		0.91 m	6.10 mm	IVURDM-QD-803	Female  1 = Wh/Or 5 = Wh/Bl 2 = Green 6 = Blue 3 = Wh/Bn 7 = Wh/Gn 4 = Orange 8 = Brown
			1.83 m		IVURDM-QD-806	
			4.57 m		IVURDM-QD-815	
			9.14 m		IVURDM-QD-830	
			15.2 m		IVURDM-QD-850	
	Straight Euro QD/ Right-Angle Euro QD		0.91 m	6.10 mm	IVURDM-QD-803RA	Male  1 = Orange 5 = Green 2 = Brown 6 = Blue 3 = Wh/Bn 7 = Wh/Or 4 = Wh/Bl 8 = Wh/Gn
			1.83 m		IVURDM-QD-806RA	
			4.57 m		IVURDM-QD-815RA	
			9.14 m		IVURDM-QD-830RA	
			15.2 m		IVURDM-QD-850RA	

Used with: iVu RDM35 remote display



8-Pin Threaded M12/Euro-Style with Shield

Specifications	Style	Dimensions (mm)	Length	Cable Diameter	Model	Pinout
<b>Cable:</b> PVC jacket, PUR (polyurethane) connector body <b>Coupling Nut:</b> Nickel-plated brass <b>Conductors:</b> 24 AWG (shielded), gold-plated contacts <b>Voltage/Current Rating:</b> 75 V ac/dc, 2.0 A <b>Temperature:</b> -40 to +105 °C <b>Environmental Rating:</b> IP67	Straight (High Flex)/DB15		1.83 m	7.60 mm	PPC06SHF	Female 
			3.96 m		PPC13SHF	
			7.01 m		PPC23SHF	
			9.75 m		PPC32SHF	
			1.83 m		7.60 mm	
	3.96 m	PPC13SRAHF				
	7.01 m	PPC23SRAHF				
	9.75 m	PPC32SRAHF				

Used with: Pro, Mini Pro, Sealed Pro

8-Pin Threaded M12/Euro-Style QD to RD

Specifications	Style	Dimensions (mm)	Length	Cable Diameter	Model	Pinout
<b>Cable:</b> Euro: PVC jacket, PUR (polyurethane) connector body <b>RD:</b> Nylon (polyamide)/PUR (polyurethane) RD connector <b>Coupling Nut:</b> Nickel-plated brass <b>Conductors:</b> 22 AWG, gold-plated contacts <b>Voltage/Current Rating:</b> 60 V ac/75 V dc, 2.0 A <b>Temperature:</b> 0 to +55 °C <b>Environmental Rating:</b> IP67	RD/Male Straight		0.31 m	6.00 mm	DELPE-81D	RD  Male 
			0.91 m		DELPE-83D	
			2.44 m		DELPE-88D	
			4.57 m		DELPE-815D	
			7.62 m		DELPE-825D	
			15.2 m		DELPE-850D	
			22.9 m		DELPE-875D	
			30.5 m		DELPE-8100D	

Used with: EZ-SCREEN LP w/RD (14 & 25 mm Resolution)

NOTE: Requires QDE-8...D, DEE2R-8...D, CSB-M128... or other M12/Euro QD cordset



8-Pin Threaded M12/Euro-Style QD to RD

Specifications	Style	Dimensions (mm)	Length	Cable Diameter	Model	Pinout
<b>Cable:</b> Euro: PVC jacket, PVC connector body, <b>RD:</b> Nylon (polyamide)/PUR (polyurethane) RD connector <b>Coupling Nut:</b> Nickel-plated brass <b>Conductors:</b> 22 AWG, gold-plated contacts <b>Voltage/Current Rating:</b> 60 V ac/75 V dc, 2.0 A <b>Temperature:</b> 0 to +55 °C <b>Environmental Rating:</b> IP67	RD/Female Straight		0.31 m	6.00 mm	DELPEF-81D	RD  Female 
			0.91 m		DELPEF-83D	
			2.44 m		DELPEF-88D	
			4.57 m		DELPEF-815D	

Used with: EZ-SCREEN LP (Cascade) w/RD (14 & 25 mm); requires QDE2R4-8...D cordset or connection of E-Stop or other hard/relay contact; for connection to DEE2R-8...D or to EZ-SCREEN LP w/8-pin QD



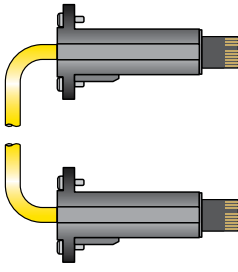

RD to RD

Specifications	Style	Dimensions (mm)	Length	Cable Diameter	Model	Pinout
<b>Cable:</b> PVC jacket, nylon (polyamide)/PUR (polyurethane) RD connector <b>Conductors:</b> 22 AWG, gold-plated contacts <b>Voltage/Current Rating:</b> 60 V ac/75 V dc, 2.0 A <b>Temperature:</b> 0 to +55 °C <b>Environmental Rating:</b> IP67	RD/RD		0.05 m	6.00 mm	DELP-110E	RD 
			0.30 m		DELP-111E	
			0.91 m		DELP-113E	
			2.44 m		DELP-118E	
			4.57 m		DELP-1115E	
			7.62 m		DELP-1125E	
			15.2 m		DELP-1150E	
			22.9 m		DELP-1175E	
			30.5 m		DELP-11100E	

Used with: EZ-SCREEN LP w/RD Cascading (14 & 25 mm Resolution)

\* Standard cordsets are yellow PVC with black overmold. For black PVC cable and overmold, add suffix **B** to model number (example, DELP-110EB).

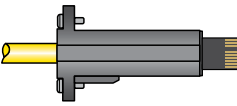
RD to Flying Lead

Specifications	Style	Dimensions (mm)	Length	Cable Diameter	Model	Pinout	
<b>Cable:</b> PVC jacket, nylon (polyamide)/PUR (polyurethane) RD connector <b>Conductors:</b> 22 AWG, gold-plated contacts <b>Voltage/Current Rating:</b> 60 V ac/75 V dc, 2.0 A <b>Temperature:</b> 0 to +55 °C <b>Environmental Rating:</b> IP67	RD		4.57 m	6.00 mm	8-Wire	RD 	
			7.62 m		RDLP-815D		RDLP6G-415D
			15.2 m		RDLP-825D		RDLP6G-425D
			22.9 m		RDLP-850D		RDLP6G-450D
			30.5 m		RDLP-875D		—
					RDLP-8100D		—

Used with: EZ-SCREEN LP w/RD (14 & 25 mm Resolution)

† For connection of E-Stop or other hard/relay contacts. See EZ-SCREEN installation manual p/n 140044 for more information.

12-Pin M12/Euro-Style with Open Shield

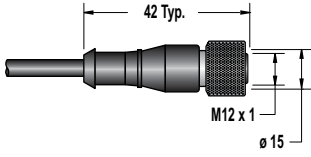
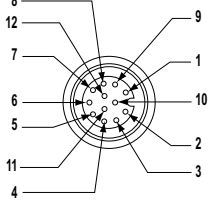
Specifications	Style	Dimensions (mm)	Length	Cable Diameter	Model	Pinout
<b>Cable:</b> PVC jacket, PUR (polyurethane) connector body <b>Coupling Nut:</b> Nickel-plated brass <b>Conductors:</b> 20 and 24 AWG, gold-plated contacts <b>Voltage Rating:</b> 250 V ac/300 V dc <b>Temperature:</b> -40 to +105 °C <b>Environmental Rating:</b> IP67	Straight		1.83 m	7.50 mm	MQDC2S-1206	Female 
			4.57 m		MQDC2S-1215	
			9.14 m		MQDC2S-1230	
			15.2 m		MQDC2S-1250	
			22.9 m		MQDC2S-1275	

Used with: IP68 Sealed P4, iVu BCR—Integrated Touch Screen models, iVu Plus (For CE compliance)

12-Pin M12/Euro-Style

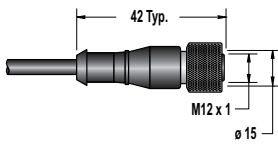
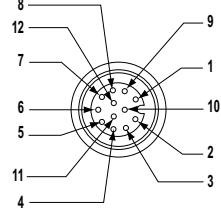
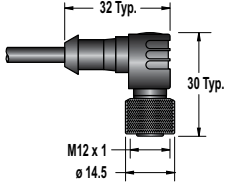
Specifications	Style	Dimensions (mm)	Length	Cable Diameter	Model	Pinout
<b>Cable:</b> PVC jacket, PUR (polyurethane) connector body <b>Coupling Nut:</b> Nickel-plated brass <b>Conductors:</b> 24, 20 AWG, gold-plated contacts <b>Voltage Rating:</b> 300 V ac/dc, 2.0, 7.0 A <b>Temperature:</b> -40 to +105 °C <b>Environmental Rating:</b> IP67	Straight		1.83 m	7.50 mm	iVUC-1206	Female 
			4.57 m		iVUC-1215	
			9.14 m		iVUC-1230	
			15.2 m		iVUC-1250	
			22.9 m		iVUC-1275	
	Right-Angle		1.83 m	7.50 mm	iVUC-1206RA	
			4.57 m		iVUC-1215RA	
			9.14 m		iVUC-1230RA	
			15.2 m		iVUC-1250RA	
			22.9 m		iVUC-1275RA	

Used with: iVu TG & BCR Remote Touch Screen models, iVu BCR—Integrated Touch Screen models, iVu Plus

12-Pin M16

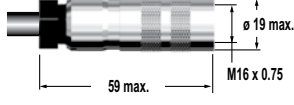
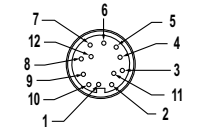
Specifications	Style	Dimensions (mm)	Length	Cable Diameter	Model	Pinout
<b>Cable:</b> PVC jacket <b>Coupling Nut:</b> nickel-plated brass <b>Conductors:</b> 22 AWG, gold-plated contacts <b>Voltage/Current Rating:</b> 60 V ac/dc, 4.0 A <b>Temperature:</b> 40 to +80° C <b>Environmental Rating:</b> IP67	Straight		3.05 m	7.60 mm	MQDC-1210ST	Female 
			9.14 m		MQDC-1230ST	
			24.4 m		MQDC-1280ST	

Used with: LT7

12-Pin QD

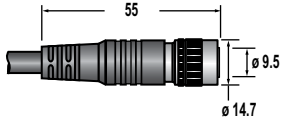
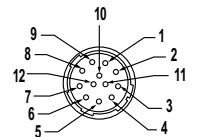
Specifications	Style	Dimensions (mm)	Length	Cable Diameter	Model	Pinout
	Straight		1.83 m	7.70 mm	P4C06	Female 
			7.01 m		P4C23	
			9.75 m		P4C32	
			15.2 m		P4C50	
			22.9 m		P4C75	
			34.0 m		P4C110	

Used with: P4, PPSIM with terminal strip to P4

12-Pin QD to DB15

Specifications	Style	Dimensions (mm)	Length	Cable Diameter	Model	Pinout
	Straight/ DB15		2.00 m	6.9 mm	P4C06SIM	Female 
			7.00 m		P4C23SIM	
			10.0 m		P4C32SIM	Male 

Used with: P4 to PPSIM

3-Pin Micro-Style

Specifications	Style	Dimensions (mm)	Length	Cable Diameter	Model	Pinout
	Straight		1.83 m	5.20 mm	MQDC-306	Female 
			4.57 m		MQDC-315	
			9.14 m		MQDC-330	
	Right-Angle		1.83 m	5.20 mm	MQDC-306RA	1 = Green 2 = Red/Black 3 = Red/White
			4.57 m		MQDC-315RA	
			9.14 m		MQDC-330RA	

Used with: MINI-BEAM ac, SM2A312 sensors

4-Pin Micro-Style

Specifications	Style	Dimensions (mm)	Length	Cable Diameter	Model	Pinout
<b>Cable:</b> PVC jacket, PUR (polyurethane) connector body <b>Coupling Nut:</b> Nickel-plated brass <b>Conductors:</b> 22 AWG, gold-plated contacts <b>Voltage/Current Rating:</b> 250 V ac/dc, 4.0 A <b>Temperature:</b> -40 to +105 °C <b>Environmental Rating:</b> IP67	Straight		1.83 m	5.70 mm	MQAC-406	Female 
			4.57 m		MQAC-415	
			9.14 m		MQAC-430	
	Right-Angle		1.83 m	5.70 mm	MQAC-406RA	1 = Red/Black 2 = Red/White 3 = Red 4 = Green
			5.00 m		MQAC-415RA	
			9.14 m		MQAC-430RA	

Used with: QS18 ac/dc sensors, Q45 ac series (suffix Q1), S18, M18, T18, Q25, S30, T30 & Q40 ac sensors (suffix Q1), Q60 ac series

4-Pin Micro-Style

Cordset Specs	Style	Dimensions (mm)	Length	Cable Diameter	Model	Pinout
<b>Cable:</b> PVC jacket, PUR (polyurethane) connector body <b>Coupling Nut:</b> Nickel-plated brass <b>Conductors:</b> 22 AWG, gold-plated contacts <b>Voltage Rating:</b> 125 V ac/150 V dc <b>Temperature:</b> -40 to +80 °C <b>Environmental Rating:</b> IP67	Straight		1.83 m	5.7 mm	MQEAC-406	Female  1 = Red/Black 2 = Red/White 3 = Red 4 = Green
			4.57 m		MQEAC-415	
			9.14 m		MQEAC-430	
	Right-Angle		1.83 m	5.70 mm	MQEAC-406RA	
			4.57 m		MQEAC-415RA	
			9.14 m		MQEAC-430RA	

Used with: SI-HG80 hinge-style switches

5-Pin Micro-Style

Specifications	Style	Dimensions (mm)	Length	Cable Diameter	Model	Pinout
<b>Cable:</b> PVC jacket, PUR (polyurethane) connector body <b>Coupling Nut:</b> Nickel-plated brass <b>Conductors:</b> 22 AWG, gold-plated contacts <b>Voltage/Current Rating:</b> 250 V ac/dc, 4.0 A <b>Temperature:</b> -40 to +105 °C <b>Environmental Rating:</b> IP67	Straight		1.83 m	6.10 mm	MQAC2-506	Female  1 = Brown 2 = Blue 3 = White 4 = Black 5 = Gray
			4.57 m		MQAC2-515	
			9.14 m		MQAC2-530	

Used with:

5-Pin Micro-Style with Shield

Specifications	Style	Dimensions (mm)	Length	Cable Diameter	Model	Pinout
<b>Cable:</b> PVC jacket, PUR (polyurethane) connector body <b>Coupling Nut:</b> Nickel-plated brass <b>Conductors:</b> 22 AWG with 22 AWG drain wire (shielded), gold-plated contacts <b>Voltage/Current Rating:</b> 250 V ac/dc, 4.0 A <b>Temperature:</b> -40 to +105 °C <b>Environmental Rating:</b> IP67	Straight		1.83 m	6.10 mm	MQVR3S-506	Female  1 = Brown 2 = White 3 = Yellow 4 = Black 5 = Blue
			1.83 m		MQVR3S-515	
			9.14 m		MQVR3S-530	
	Right-Angle		1.83 m	6.10 mm	MQVR3S-506RA	
			4.57 m		MQVR3S-515RA	
			9.14 m		MQVR3S-530RA	

Used with: QT50U ac/dc sensors, EZ-LIGHT ac indicators

5-Pin Threaded M12/Micro-Style

Specifications	Style	Dimensions (mm)	Length	Cable Diameter	Model	Pinout
<b>Cable:</b> PVC jacket, PUR (polyurethane) connector body <b>Coupling Nut:</b> Nickel-plated brass <b>Conductors:</b> 22 AWG (shielded), gold-plated contacts <b>Voltage/Current Rating:</b> 250 V ac/dc, 4.0 A <b>Temperature:</b> -40 to +105 °C <b>Environmental Rating:</b> IP67	Straight		1.83 m	5.60 mm	MQEAC-606	Female  1 = Red/White 2 = Red 3 = Green 4 = Red/Yellow 5 = Red/Black 6 = Red/Blue
			4.57 m		MQEAC-615	
			9.14 m		MQEAC-630	
	Right-Angle		1.83 m	5.60 mm	MQEAC-606RA	
			4.57 m		MQEAC-615RA	
			9.14 m		MQEAC-630RA	

Used with: SI-HG63 hinge-style switches

### 3-Pin Mini-Style

Specifications	Style	Dimensions (mm)	Length	Cable Diameter	Model	Pinout
<b>Cable:</b> PVC jacket, PUR (polyurethane) connector body <b>Coupling Nut:</b> Nylon <b>Conductors:</b> 18 AWG, PVC insulation, gold-plated contacts <b>Voltage/Current Rating:</b> 300 V ac/dc, 9.0 A <b>Temperature:</b> -40 to +80 °C <b>Environmental Rating:</b> IP67	Straight		1.83 m	7.00 mm	MBCC-306	Female 
			3.66 m		MBCC-312	
			9.14 m		MBCC-330	
	Straight		1.83 m		SMICC-306	1 = Brown 3 = Blue 4 = Black
			3.66 m		SMICC-312	
			9.14 m		SMICC-330	
	Straight		1.83 m		SM30CC-306	1 = Red/Black 3 = Red/White 4 = Green
			3.66 m		SM30CC-312	

Used with: Q45, SMI30 Intrinsically, SM30 2-wire ac sensors safe dc sensors,

### 3-Pin Mini-Style

Specifications	Style	Dimensions (mm)	Length	Cable Diameter	Model	Pinout
<b>Cable:</b> PVC jacket, PUR (polyurethane) connector body <b>Coupling Nut:</b> Nickel-plated brass <b>Conductors:</b> 18 AWG, PVC insulation, gold-plated contacts <b>Voltage Rating:</b> 250 V ac/300 dc <b>Temperature:</b> -40 to +80 °C <b>Environmental Rating:</b> IP67	Straight		4.75 m	7.00 mm	QDS-315C	Female 
			7.62 m		QDS-325C	
			15.2 m		QDS-350C	
			22.9 m		QDS-375C	
			30.5 m		QDS-3100C	

Used with: EZ-SCREEN Emitters w/3-pin mini-style QD (Point & Grid), EZAC Box w/3-pin mini-style QD

### 4-Pin Mini-Style

Specifications	Style	Dimensions (mm)	Length	Cable Diameter	Model	Pinout
<b>Cable:</b> PVC jacket, PUR (polyurethane) connector body <b>Coupling Nut:</b> Nylon <b>Conductors:</b> 18 AWG, gold-plated contacts <b>Voltage/Current Rating:</b> 300 V ac/dc, 9.0 A <b>Temperature:</b> -40 to +80 °C <b>Environmental Rating:</b> IP67	Straight		1.83 m	7.00 mm	MBCC-406	Female 
			3.66 m		MBCC-412	
			9.14 m		MBCC-430	



Used with: Q45 dc sensors (suffix Q), OMNI-BEAM dc power blocks, SM30 dc sensors, OTB w/solid-state output, STB with solid-state output, Q45 4-wire ac/dc

### 5-Pin Mini-Style

Specifications	Style	Dimensions (mm)	Length	Cable Diameter	Model	Pinout
<b>Cable:</b> PVC jacket, PUR (polyurethane) connector body <b>Coupling Nut:</b> Nylon <b>Conductors:</b> 18 AWG, gold-plated contacts <b>Voltage/Current Rating:</b> 300 V ac/dc, 9.0 A <b>Temperature:</b> -40 to +80 °C <b>Environmental Rating:</b> IP67	Straight		1.83 m	7.00 mm	MBCC-506	Female 
			3.66 m		MBCC-512	
			9.14 m		MBCC-530	

Used with: Q45 Laser Retro, OMNI-BEAM ac power blocks, OMNI-BEAM dc w/ e/m relay, OTB & LTB w/SPDT relay, Q45 5-wire ac, STB with e/m relay

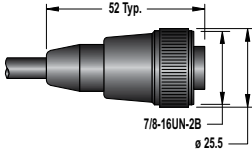
5-Pin Mini-Style with Shield

Specifications	Style	Dimensions (mm)	Length	Cable Diameter	Model	Pinout
<b>Cable:</b> PVC jacket, PUR (polyurethane) connector body <b>Coupling Nut:</b> Nylon <b>Conductors:</b> 22 AWG (shielded), PVC insulation, gold-plated contacts <b>Voltage/Current Rating:</b> 300 V ac/dc, 9.0 A <b>Temperature:</b> -40 to +80 °C <b>Environmental Rating:</b> IP67	Straight		1.83 m	6.10 mm	MBCC2-506	Female  1 = Brown 2 = White 3 = Blue 4 = Black 5 = Yellow
			3.66 m		MBCC2-512	
			9.14 m		MBCC2-530	

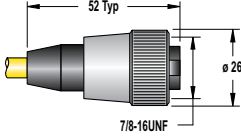
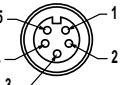

Used with: QT50U, Q45U, Q45UR

5-Pin Mini-Style with Green/Yellow Grounding Wire

Specifications	Style	Dimensions (mm)	Length	Cable Diameter	Model	Pinout
<b>Cable:</b> PVC jacket, PUR (polyurethane) connector body <b>Coupling Nut:</b> Nickel-plated brass <b>Conductors:</b> 20 AWG, gold-plated contacts <b>Voltage/Current Rating:</b> 250 V ac/300 V dc, 9.0 A <b>Temperature:</b> -40 to +90 °C <b>Environmental Rating:</b> IP67	Straight		4.75 m	7.00 mm	QDS-515C	Female  1 = Black 2 = Blue 3 = Gn/Ye 4 = Brown 5 = White
			7.62 m		QDS-525C	
			15.2 m		QDS-550C	

Used with: EZ-SCREEN Receivers w/5-pin mini-style QD & TEST (Point & Grid), EZAC Box w/5-pin mini-style QD

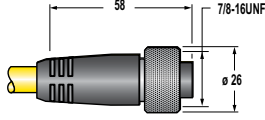
8-Pin Threaded M12/Euro-Style with Shield

Specifications	Style	Dimensions (mm)	Length	Cable Diameter	Model	Pinout
<b>Cable:</b> PVC jacket, PUR (polyurethane) connector body <b>Coupling Nut:</b> Nickel-plated brass <b>Conductors:</b> 24 AWG (shielded), gold-plated contacts <b>Voltage/Current Rating:</b> 75 V ac/dc, 2.0 A <b>Temperature:</b> -40 to +105 °C <b>Environmental Rating:</b> IP67	Straight		4.57 m	7.00 mm	QDC-515C	Female  1 = Black 2 = Blue 3 = Drain 4 = Brown 5 = White
			7.62 m		QDC-525C	
			15.2 m		QDC-550C	
			22.9 m		MAQDC-575C	
			30.5 m		MAQDC-5100C	
			38.1 m		MAQDC-5125C	
			45.7 m		MAQDC-5150C	

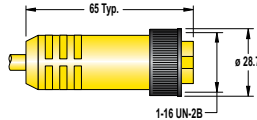
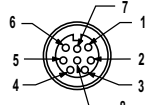

Used with: MINI-ARRAY, High-Resolution MINI-ARRAY

8-Pin Mini-Style

Specifications	Style	Dimensions (mm)	Length	Cable Diameter	Model	Pinout
<b>Cable:</b> PVC jacket, PUR (polyurethane) connector body <b>Coupling Nut:</b> Nylon <b>Conductors:</b> 20 AWG, PVC insulation, gold-plated contacts <b>Voltage Rating:</b> 250 V ac/300 V dc <b>Temperature:</b> -40 to +80 °C <b>Environmental Rating:</b> IP67	Straight		4.51 m	6.90 mm	QDS-815C	Female  1 = Brown 2 = Or/Bk 3 = Orange 4 = White 5 = Black 6 = Blue 7 = Gn/Ye 8 = Violet
			7.62 m		QDS-825C	
			15.2 m		QDS-850C	
			22.9 m		QDS-875C	

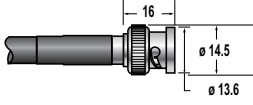

Used with: EZ-SCREEN Receivers w/8-pin mini-style QD (Point & Grid), DUO-TOUCH SG Run Bar, EZAC Box w/8-pin mini-style QD

BNC Coaxial Video

Specifications	Style	Dimensions (mm)	Length	Cable Diameter	Model	Pinout
	Video Coaxial with BNC		1.83 m	6.00 mm	BNC06	
			4.57 m		BNC15	
			9.14 m		BNC30	
			14.6 m		BNC48	

Used with: Pro, P4

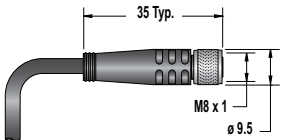
BNC to 4-Pin Threaded M8/Pico-Style with Shield

Specifications	Style	Dimensions (mm)	Length	Cable Diameter	Model	Pinout
<b>Cable:</b> PVC jacket, PUR (polyurethane) connector body <b>Coupling Nuts:</b> Nickel-plated brass on QD end <b>Conductors:</b> 26 AWG <b>Voltage/Current Rating:</b> 125 V ac/ 125 V dc, 4.0 A <b>Temperature:</b> -40 to +105 °C <b>Environmental Rating:</b> IP67	BNC/ Pico QD Straight		2.00 m	4.40 mm	PKG4M-2/CS	Female  1 = Brown 3 = Blue 2 = Not Used 4 = Drain Male 
			5.00 m		PKG4M-5/CS	
			9.00 m		PKG4M-9/CS	

Used with: IP68 Sealed P4

Communication

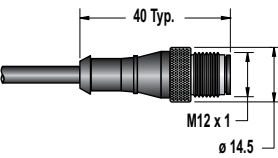
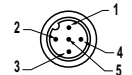
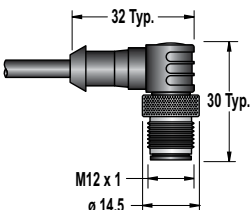
Specifications	Style	Dimensions (mm)	Length	Cable Diameter	Model	Pinout
	5-Pin M12/Euro-Style, Straight		1.83 m	5.60 mm	MQDMC-506	<b>Male</b>  1 = Brown 2 = White 3 = Blue 4 = Black 5 = Gray
			4.57 m		MQDMC-515	
			9.14 m		MQDMC-530	
	5-Pin M12/Euro-Style, Right-Angle		1.83 m	5.60 mm	MQDMC-506RA	
			4.57 m		MQDMC-515RA	
			9.14 m		MQDMC-530RA	

Used with: EZ-ARRAY to INTUSB485-1 USB Serial Adapter

DB9 Communication Cordsets

Style	Dimensions (mm)	Length	Cable Diameter	Model	Pinout
Male DB9/ Female DB9		1.83 m	6.00 mm	DB9P06	
		4.57 m		DB9P15	
		9.14 m		DB9P30	
Male DB9/ Female DB9		3.00 m	5.00 mm	AG4-PCD9-3	
		5.00 m		AG4-PCD9-5	
		10.0 m		AG4-PCD9-10	
USB/ Male DB9		1.00 m	4.6 mm	AG4-PCD9USB-1	 
Male DB9/ Female DB9		2.00 m	5.00 mm	MASC	 2 = Transmit (TX) 3 = Receive (RX) 5 = Ground (GRD)

Used with: Pro, AG4, AG4 Serial-to USB Adapter, MINI-ARRAY, High-Resolution, MINI-ARRAY

DB15 Configuration/Machine Interface Cordsets

Style	Dimensions (mm)	Length	Cable Diameter	Model	Pinout
DB15		5.00 m	8.50 mm	AG4-CPD15-5	
		10.0 m		AG4-CPD15-10	
		25.0 m		AG4-CPD15-25	
		25.0 m		AG4-CPD15-50W	

Used with: AG4

RJ45 Ethernet Cordsets

Style	Dimensions (mm)	Length	Cable Diameter	Model	Pinout
Cat5e Shielded		2.13 m	6.80 mm	STP07	
Cat5e Crossover Shielded				STPX07	
Cat5e Shielded		7.62 m		STP25	
Cat5e Crossover Shielded				STPX25	
Cat5e Shielded		15.2 m		STP50	
Cat5e Crossover Shielded				STPX50	
Cat5e Shielded		22.9 m		STP75	
Cat5e Crossover Shielded				STPX75	

Used with: Pro, P4, SC22-3E



RJ45 Ethernet to 4-Pin Threaded M8/Pico-Style Cordsets

Style	Dimensions (mm)	Length	Cable Diameter	Model	Pinout
Cat5e Shielded		2.00 m	6.00 mm	IVUC-E-406	Male 
		5.00 m		IVUC-E-415	Female  1 = Blue TX- 2 = White/Blue TX+ 3 = White/Orange RX+ 4 = Orange RX
		9.00 m		IVUC-E-430	
		16.0 m		IVUC-E-450	
		23.0 m		IVUC-E-475	

Used with: iVu Plus

8-Pin Threaded M12/Euro-Style Cordsets with Shield

Style	Dimensions (mm)	Length	Cable Diameter	Model	Pinout
Straight		1.83 m	7.90 mm	STP-MAQDC-806	Male 
		4.57 m		STP-MAQDC-815	Male  1 = Wh/Bl 5 = Wh/Gr 2 = Wh/Br 6 = Wh/Or 3 = Brown 7 = Blue 4 = Orange 8 = Green
		9.14 m		STP-MAQDC-830	

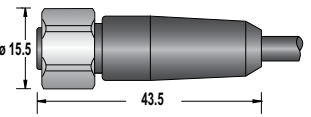
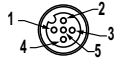

Used with: IP68 Sealed P4

5-Pin Threaded M12/Euro-Style—Washdown Stainless Steel

Specifications	Style	Dimensions (mm)	Length	Cable Diameter	Model	Pinout
<b>Cable:</b> PVC jacket and over-mold, EPDM o-ring <b>Coupling Nut:</b> Stainless steel coupling nut <b>Conductors:</b> 22 AWG, gold-plated contacts <b>Voltage/Current Rating:</b> 300 V dc, 4.0 A <b>Temperature:</b> -40 to +105 °C <b>Environmental Rating:</b> IP69K	Straight		1.83 m (6 ft)	4.80 mm	MQDC-WDSS-0506	Female  1 = Brown 2 = White 3 = Blue 4 = Black 5 = Gray
			4.57 m (15 ft)		MQDC-WDSS-0515	
			9.14 m (30 ft)		MQDC-WDSS-0530	

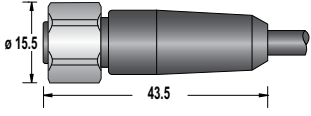

Used with: Q4X, Q3X

4-Pin Threaded M12/Euro-Style—Washdown Stainless Steel

Specifications	Style	Dimensions (mm)	Length	Cable Diameter	Model	Pinout
<b>Cable:</b> PVC jacket and over-mold, EPDM o-ring <b>Coupling Nut:</b> Stainless steel coupling nut <b>Conductors:</b> 22 AWG, gold-plated contacts <b>Voltage/Current Rating:</b> 300 V dc, 4.0 A <b>Temperature:</b> -40 to +105 °C <b>Environmental Rating:</b> IP69K	Straight		1.83 m (6 ft)	4.80 mm	MQDC-WDSS-0406	Female  1 = Brown 2 = White 3 = Blue 4 = Black
			4.57 m (15 ft)		MQDC-WDSS-0415	
			9.14 m (30 ft)		MQDC-WDSS-0430	

Used with: QM26

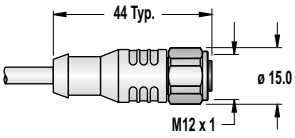
5-Pin Threaded M12/Euro-Style—Washdown

Specifications	Style	Dimensions (mm)	Length	Cable Diameter	Model	Pinout
<b>Cable:</b> Polypropylene jacket and connector body <b>Coupling Nut:</b> Stainless steel <b>Conductors:</b> 22 AWG, gold-plated contacts <b>Voltage/Current Rating:</b> 250 V ac/dc, 4.0 A <b>Temperature:</b> -4 to +105 °C <b>Environmental Rating:</b> IP68	Straight		1.83 m	4.50 mm	MQDCWD-506	Female  1 = Brown 2 = White 3 = Blue 4 = Black 5 = Gray
			9.14 m		MQDCWD-530	

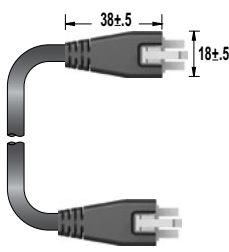
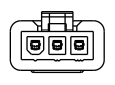

Used with: M25U, QM26

Molex for Cascading

Specifications	Style	Dimensions (mm)	Length	Cable Diameter	Model	Pinout
Cable: PVC Black Coupling Nut: Slide Snap	Straight		0.15 m	6.6 mm	LQMAEC-3005SS	
			0.31 m		LQMAEC-301SS	
			0.91 m		LQMAEC-303SS	
			1.83 m		LQMAEC-306SS	
			3.66 m		LQMAEC-312SS	
			6.10 m		LQMAEC-320SS	
			9.14 m		LQMAEC-330SS	

Used with: AC WLB32

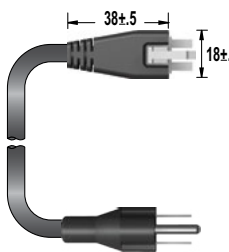
Molex to Power

Specifications	Style	Dimensions (mm)	Length	Cable Diameter	Model	Pinout
Cable: PVC Coupling Nut: Slide Snap	Straight		3.0 m	6.6 mm	LQMAC-306B	

Used with: AC WLB32

QD End-Caps

Cordset Specs	Style	Dimensions (mm)	Model
Replace or convert EZ-SCREEN Grid and Point hard-wire terminal chamber end cap to QD model.	8-pin Euro QD	Converts terminal chamber end cap to QD model	EZA-QDE-8E
	8-pin Euro QD		EZA-QDR-8E

Used with: EZ-SCREEN Emitters w/Terminal Chamber (Point & Grid), EZ-SCREEN Receivers w/Terminal Chamber (Point & Grid)

Unterminated Bulk Cable

Cordset Specs	Dimensions (mm)	Length	Models
<b>Cable:</b> PVC jacket <b>Conductors:</b> 20 AWG, PVC insulation <b>Voltage Rating:</b> 250 V ac/300 V dc <b>Temperature:</b> -40 to +80 °C	3-conductor (Brown, Blue, Green/Yellow)	7.6 m	UTB-325C
		15.2 m	UTB-350C
		30.4 m	UTB-3100C
		76.2 m	UTB-3250C
	5-conductor (Black, Blue, Brown, White, Green/Yellow)	7.6 m	UTB-525C
		15.2 m	UTB-550C
		30.4 m	UTB-5100C
		76.2 m	UTB-5250C
	8-conductor (Brown, Orange/Black, Orange, White, Black, Blue, Violet, Green/Yellow)	7.6 m	UTB-825C
		15.2 m	UTB-850C
		30.4 m	UTB-8100C
		76.2 m	UTB-8250C

Used with: EZ-SCREEN Emitters w/Terminal Chamber (Point & Grid), EZAC Interface Boxes, EZ-SCREEN Emitters w/Terminal Chamber & TEST (Point & Grid), EZAC Interface Boxes, EZ-SCREEN Receivers w/Terminal Chamber (Point & Grid), EZAC Interface Boxes, DUO-TOUCH SG Run Bars

Cable Glands

Cordset Specs	Dimensions (mm)	Cable Diameter	Model	Size
Secures the cable end in the housing and seals the point of connection  Available for EZ-SCREEN Point and Grid, rope pulls and safety interlock switches		3.0 to 8.0 mm	SI-QS-CG13	PG13.5 Plastic
		3.0 to 8.0 mm	SI-QS-CGM16	M16 x 1.5 Plastic
		5.0 to 12.0 mm	SI-QS-CGM20	M20 x 1.5 Plastic
		5.0 to 12.0 mm	SI-QM-CGM20	M20 x 1.5 Metal

Used with: EZ-SCREEN w/Terminal Chamber (Point & Grid), SI-QS75 Safety Interlock Switches, SI-LS83 Safety Interlock Switches, • SI-QS90 Safety Interlock Switches, SI-LS100 Safety Interlock Switches, SI-LS31 Safety Interlock Switches, SI-LS42 Safety Interlock Switches, RP-LS42 Rope Pull Switches, • SI-LM40 Safety Interlock Switches, SI-QM100 Safety Interlock Switches, SI-LM40 Safety Interlock Switches, RP-RM83 Rope Pull Switches, RP-LM40 Rope Pull Switches, RP-QM72/QMT72 Rope Pull Switches, RP-QM90 Rope Pull Switch

Cable Glands

Cordset Specs	Dimensions (mm)	Thread Conversion	Model	Size
Connects conduit of different diameters  Available for EZ-SCREEN Point and Grid, rope pulls and safety interlock switches		PG 13.5 to 1/2" NPT	<b>SI-QM-13</b>	1/2" NPT to PG13.5 Metal
		PG 13.5 to M20	<b>SI-QM-13-M20</b>	M20 to PG13.5 Metal
		M16 x 1.5 to 1/2" - 14 NPT	<b>SI-QS-M16</b>	1/2" - 14 NPT Plastic
		M20 x 1.5 to 1/2" - 14 NPT	<b>SI-QS-M20</b>	1/2" - 14 NPT Plastic
		M20 x 1.5 to 1/2" - 14 NPT	<b>SI-QM-M20</b>	1/2" - 14 NPT Metal

**Used with:** EZ-SCREEN w/Terminal Chamber (Point & Grid), EZ-SCREEN w/Terminal Chamber (Point & Grid), SI-QS75 Safety Interlock Switches, SI-LS83 Safety Interlock Switches, SI-QS90 Safety Interlock Switches, SI-LS100 Safety Interlock Switches, SI-LS31 Safety Interlock Switches, SI-LS42 Safety Interlock Switches, RP-LS42 Rope Pull Switches, SI-LM40 Safety Interlock Switches, SI-QM100 Safety Interlock Switches, SI-LM40 Safety Interlock Switches, RP-RM83 Rope Pull Switches, RP-LM40 Rope Pull Switches, RP-QM72/QMT72 Rope Pull Switches, RP-QM90 Rope Pull Switch

Pico-Style Field-Wireable Connectors (M8)

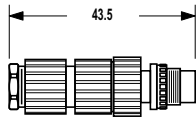
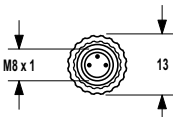
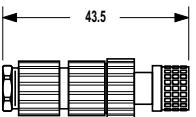
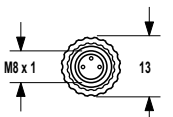
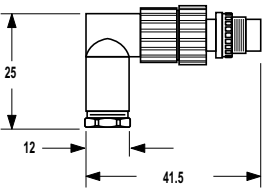
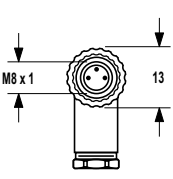
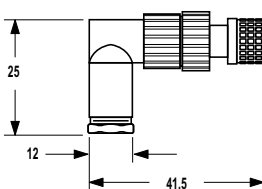
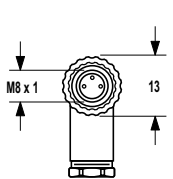
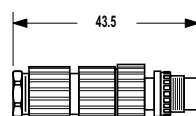
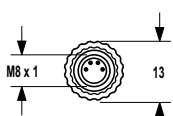
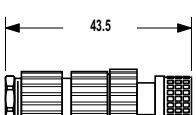
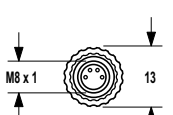
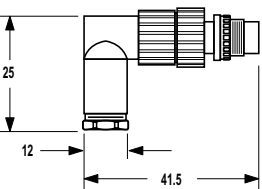
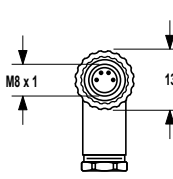
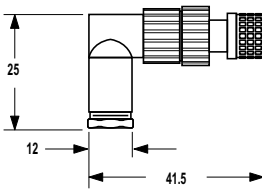
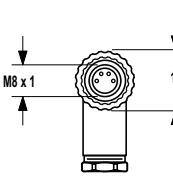
Cordset Specs	Style	Dimensions (mm)	Model	Pinout
<p><b>Contacts:</b> Gold-plated, rated 60V ac/dc max., 4.0 A max.  <b>Cable Diameter:</b> 4.0 to 5.0 mm  <b>Temperature:</b> -25 to +70 °C  <b>Environmental Rating:</b> NEMA 6P, IP67</p>	3-Pin Male Straight		FIC-M8M3	
	3-Pin Female Straight		FIC-M8F3	
	3-Pin Male Right-Angle		FIC-M8M3A	
	3-Pin Female Right-Angle		FIC-M8F3A	
	4-Pin Male Straight		FIC-M8M4	
	4-Pin Female Straight		FIC-M8F4	
	4-Pin Male Right-Angle		FIC-M8M4A	
	4-Pin Female Right-Angle		FIC-M8F4A	

Euro-Style Field-Wireable Connectors (M12)

Cordset Specs	Style	Dimensions (mm)	Model	Pinout
<p><b>Contacts:</b> Gold-plated; 4-pin models rated 250 V ac/dc max., 4.0 A max.; 5-pin models rated 50 V ac/dc max., 4.0 A max.</p> <p><b>Cable Diameter:</b> 4.0 to 5.0 mm</p> <p><b>Temperature:</b> -25 to +90 °C</p> <p><b>Environmental Rating:</b> NEMA 6P, IP67</p>	4-Pin Male Straight		FIC-M12M4	
	4-Pin Female Straight		FIC-M12F4	
	4-Pin Male Right-Angle		FIC-M12M4A	
	4-Pin Female Right-Angle		FIC-M12F4A	
	5-Pin Male Straight		FIC-M12M5	
	5-Pin Female Straight		FIC-M12F5	

Euro-Style Field-Wireable Connectors (M12)

Cordset Specs	Style	Dimensions (mm)	Model	Pinout
<p><b>Contacts:</b> Gold-plated; 4-pin models rated 250 V ac/dc max., 4.0 A max.; 5-pin models rated 50 V ac/dc max., 4.0 A max.</p> <p><b>Cable Diameter:</b> 4.0 to 5.0 mm</p> <p><b>Temperature:</b> -25 to +90 °C</p> <p><b>Environmental Rating:</b> NEMA 6P, IP67</p>	5-Pin Male Right-Angle		FIC-M12M5A	
	5-Pin Female Right-Angle		FIC-M12F5A	

BRT-.6

Description: Round, acrylic target  
 Reflectivity Factor: 1.0  
 Temperature: -20 to +60 °C

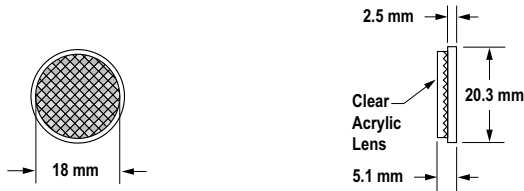

BRT-1

Description: Round, acrylic target  
 Reflectivity Factor: 1.0  
 Temperature: -20 to +60 °C

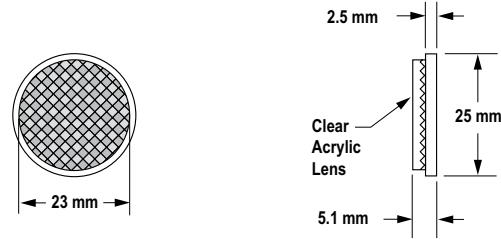

BRT-25R

Description: Round, rivet-secured acrylic target  
 Reflectivity Factor: 1.0  
 Temperature: -20 to +60 °C

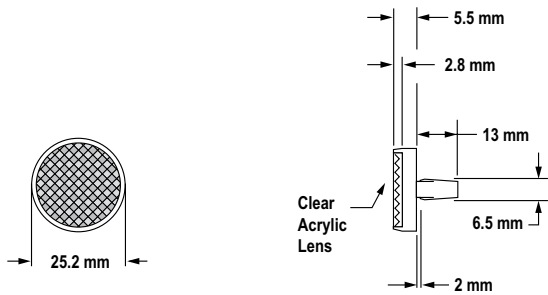

BRT-1.5

Description: Round, acrylic target  
 Reflectivity Factor: 1.0  
 Temperature: -20 to +60 °C

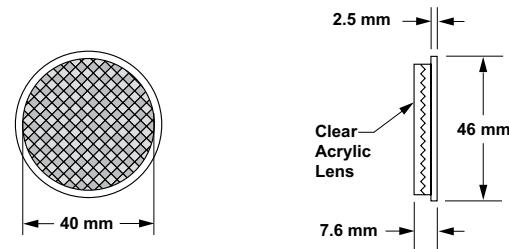

BRT-34

Description: Round, acrylic target  
 Reflectivity Factor: 1.2  
 Temperature: -20 to +60 °C

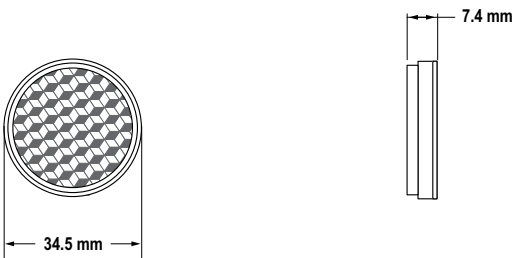

BRT-34T

Description: Round, acrylic target includes mounting tape  
 Reflectivity Factor: 1.2  
 Temperature: -20 to +60 °C





**BRT-35DM**

Description: Round, acrylic target with mounting stud  
 Reflectivity Factor: 1.2  
 Temperature: -20 to +60 °C  
 Other: This target has micro-prism geometry.

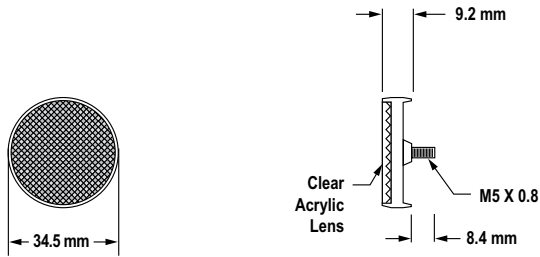

**BRT-41AHT**

Description: Round, borosilicate (Pyrex type) glass target  
 Reflectivity Factor: 1.0  
 Temperature: -20 to +200 °C

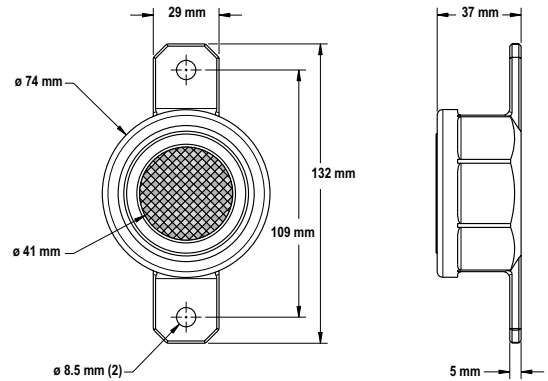

**BRT-42**

Description: Round, acrylic target  
 Reflectivity Factor: 1.0  
 Max. Temperature: 65 °C

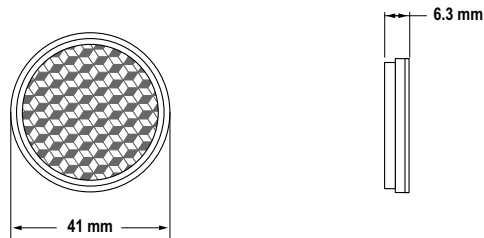

**BRT-42A**

Description: Round, acrylic target  
 Reflectivity Factor: 1.0  
 Temperature: -20 to +60 °C

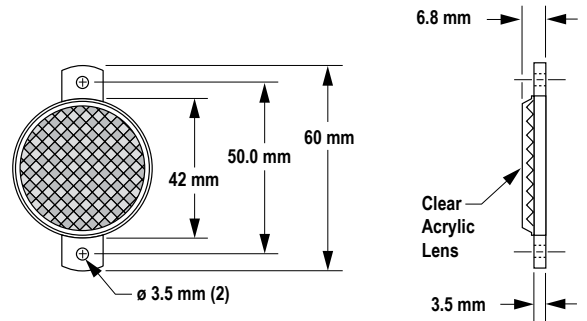

**BRT-42D**

Description: Round, acrylic target with mounting stud  
 Reflectivity Factor: 1.0  
 Temperature: -20 to +60 °C

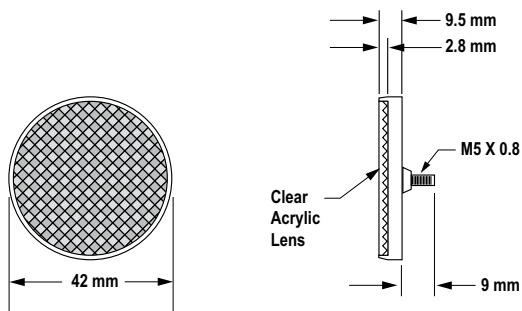

**BRT-2A**

Description: Round, acrylic target  
 Reflectivity Factor: 1.0  
 Max. Temperature: 65 °C

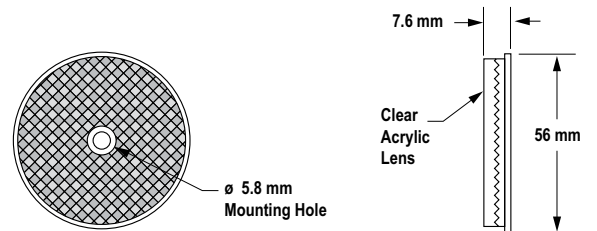

BRT-50

Description: Round, acrylic target  
 Reflectivity Factor: 1.0  
 Temperature: -20 to +60 °C

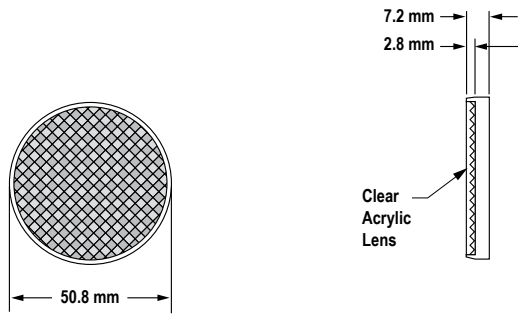

BRT-50D

Description: Round, acrylic target with mounting stud  
 Reflectivity Factor: 1.0  
 Temperature: -20 to +60 °C  
 Other: Optional brackets are available.

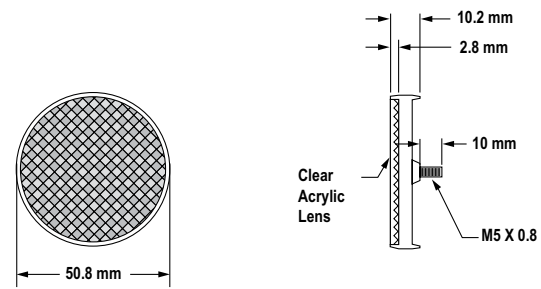

BRT-50R

Description: Round, rivet-secured acrylic target  
 Reflectivity Factor: 1.0  
 Max. Temperature: -20 to +60 °C  
 Other: Optional brackets are available.

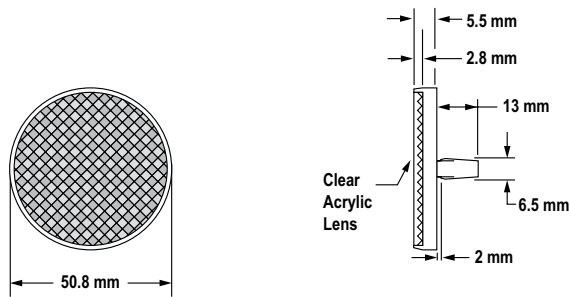

BRT-3

Description: Round, acrylic target  
 Reflectivity Factor: 1.0  
 Temperature: -20 to +60 °C  
 Other: Optional brackets are available.

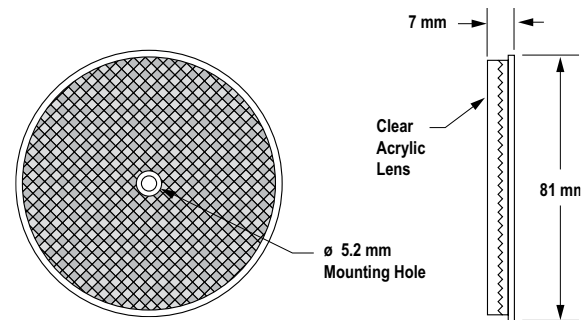

BRT-84

Description: Round, acrylic target  
 Reflectivity Factor: 1.4  
 Max. Temperature: -20 to +60 °C  
 Other: Optional brackets are available.

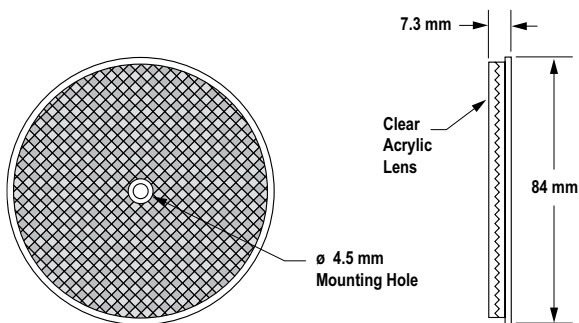

**BRT-11X11M**

Description: Square, acrylic target  
 Reflectivity Factor: 1.2  
 Temperature: -20 to +60 °C  
 Other: This target has micro-prism geometry.



**BRT-11X11MD**

Description: Square, acrylic target with mounting stud  
 Reflectivity Factor: 1.2  
 Temperature: -20 to +60 °C  
 Other: This target has micro-prism geometry.

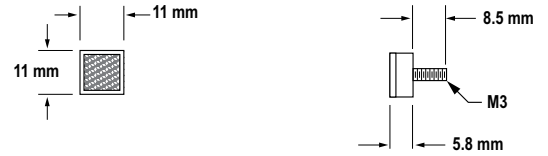

**BRT-35X35B**

Description: Square, acrylic target  
 Reflectivity Factor: 1.3  
 Temperature: -20 to +60 °C

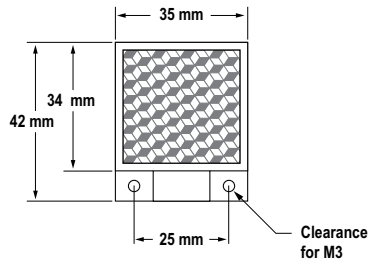

**BRT-35X35BM**

Description: Square, acrylic target  
 Reflectivity Factor: 1.2  
 Temperature: -20 to +60 °C  
 Other: This target has micro-prism geometry.

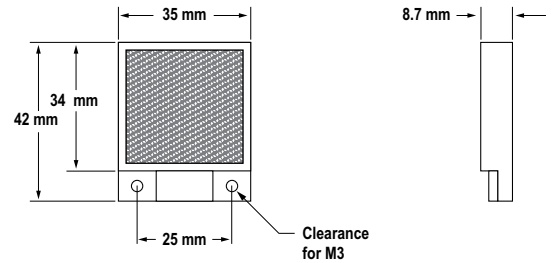

**BRT-2X2**

Description: Square, acrylic target  
 Reflectivity Factor: 1.0  
 Max. Temperature: 50 °C  
 Others: Optional brackets are available.

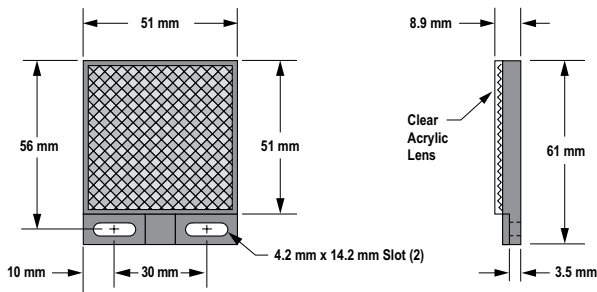

**BRT-2X2LVC**

Description: Square, acrylic target  
 Reflectivity Factor: 1.0  
 Max. Temperature: -20 to +60 °C  
 Others: Optional brackets are available.

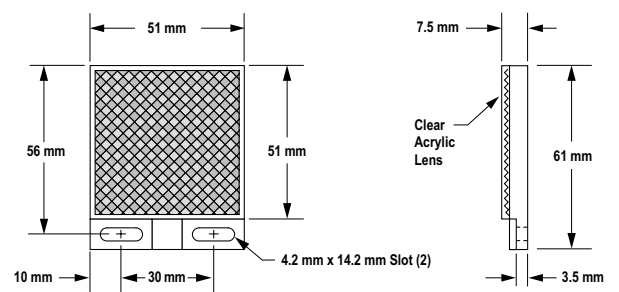

BRT-51X51BM

Description: Square, acrylic target  
 Reflectivity Factor: 1.5 Max. Temperature: 50 °C  
 Other: This target has micro-prism geometry. Optional brackets are available. Replaces reflector BRT-36X40BM.

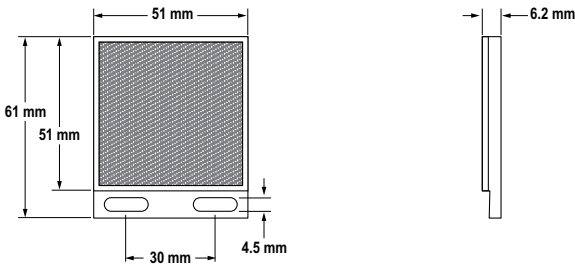

BRT-84X84A

Description: Square, acrylic target  
 Reflectivity Factor: 2.0  
 Temperature: -20 to +60 °C

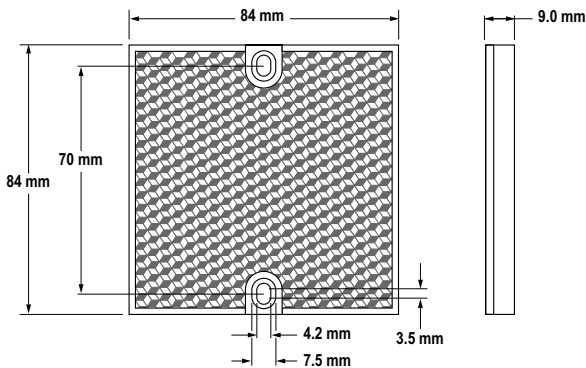

BRT-92X92CB

Description: Square, acrylic target with black mounting base  
 Reflectivity Factor: 3.0  
 Max. Temperature: 50 °C  
 Other: Optional brackets are available.

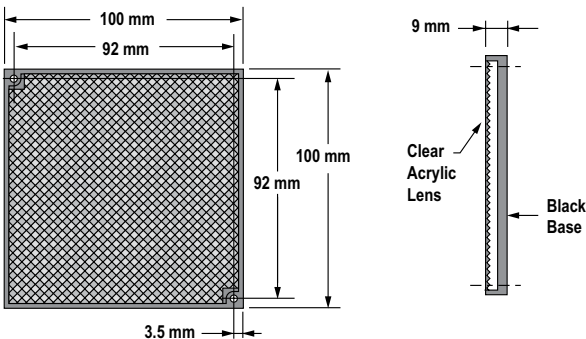

BRT-77X77C

Description: Square, acrylic target  
 Reflectivity Factor: 2.0  
 Temperature: -20 to +60 °C  
 Other: Optional brackets are available.

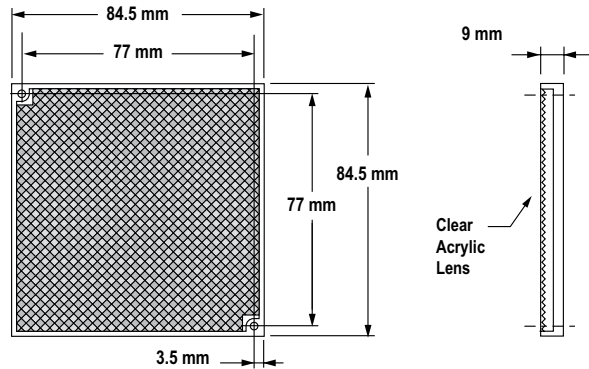

BRT-92X92C

Description: Square, acrylic target  
 Reflectivity Factor: 3.0  
 Temperature: -20 to +60 °C  
 Other: Optional brackets are available.

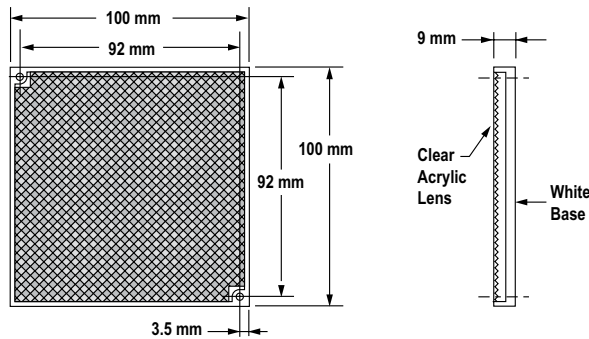

BRT-4HT

Description: Square, aluminum target  
 Reflectivity Factor: 0.15  
 Max. Temperature: 480 °C  
 Other: This target is not recommended for polarized retroreflective sensors.

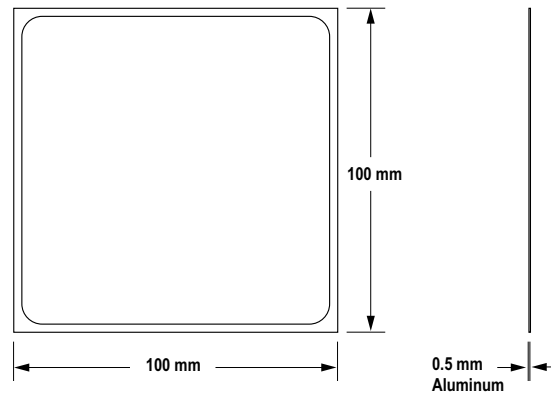

BRT-250 (250 x 250 mm)

Temperature: -20 to +50° C

Other: Square reflector with rigid aluminum backing for use with LT7

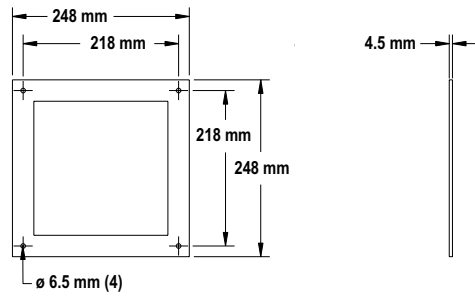

BRT-540 (540 x 540 mm)

Temperature: -20 to +50° C

Other: Square reflector with rigid aluminum backing for use with LT7

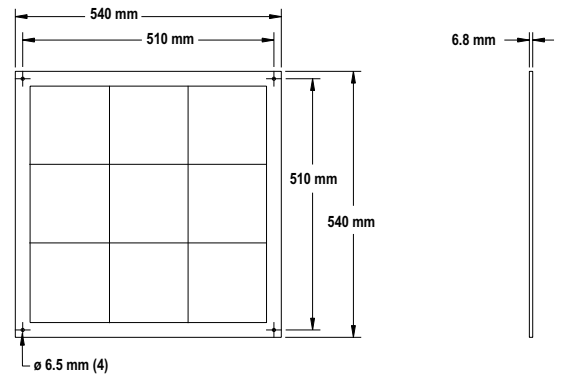

BRT-700 (700 x 700 mm)

Temperature: -20 to +50° C

Other: Square reflector with rigid aluminum backing for use with LT7

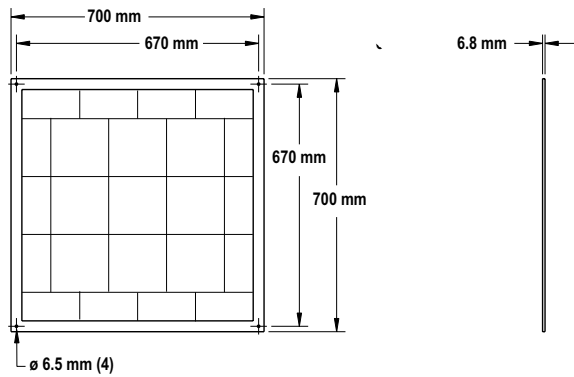

BRT-23X14CM

Description: Rectangular, acrylic target  
 Reflectivity Factor: 1.2  
 Temperature: -20 to +60° C  
 Other: This target has micro-prism geometry.

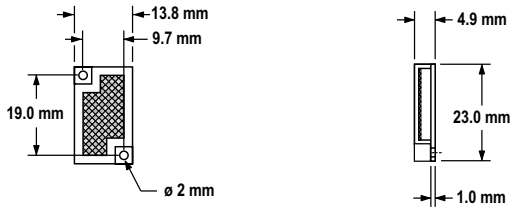

BRT-30X20M

Description: Rectangular, acrylic target  
 Reflectivity Factor: 1.2  
 Temperature: -20 to +60° C

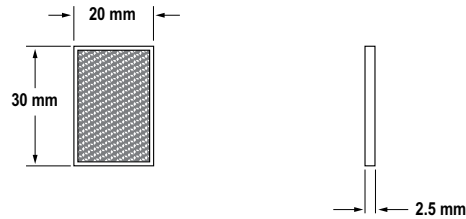

BRT-30X20MT

Description: Rectangular, acrylic target includes mounting tape  
 Reflectivity Factor: 1.2  
 Temperature: -20 to 60° C

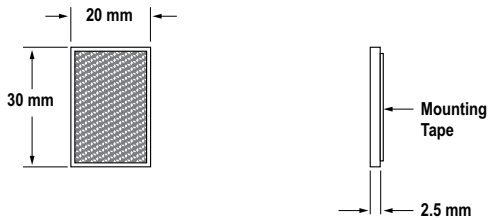

BRT-32X20AM

Description: Rectangular, thin profile acrylic target  
 Reflectivity Factor: 1.2  
 Temperature: -20 to +60° C  
 Other: This target has micro-prism geometry.

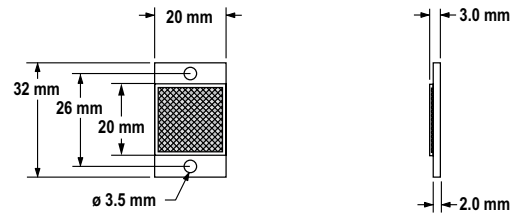

BRT-32X22A

Description: Rectangular, acrylic target  
 Reflectivity Factor: 1.3  
 Max. Temperature: 65° C

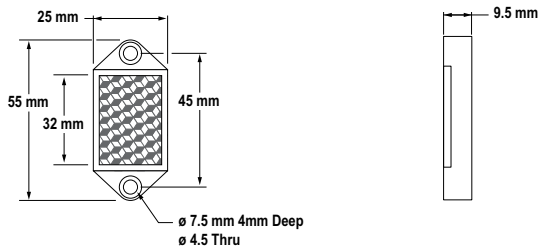

BRT-35X20A BRT-35X20AB

Description: Rectangular, acrylic target\*  
 Reflectivity Factor: 1.4  
 Temperature: -20 to +60° C

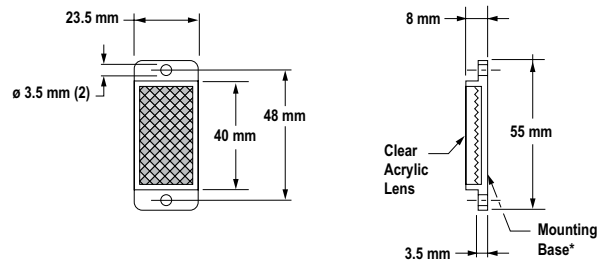

\*Mounting base available in white (BRT-35X20A) or black (BRT-35X20AB).

BRT-40X18A

Description: Rectangular, acrylic target  
 Reflectivity Factor: 1.0  
 Temperature: -20 to +60 °C

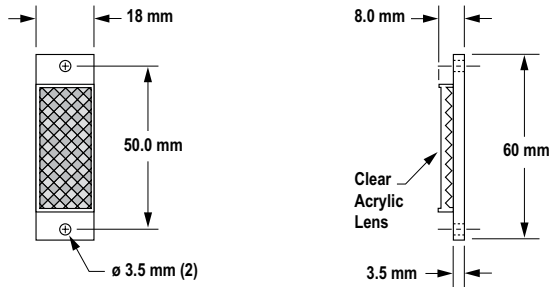

BRT-40X19A

Description: Rectangular, acrylic target  
 Reflectivity Factor: 1.3  
 Temperature: -20 to +60 °C

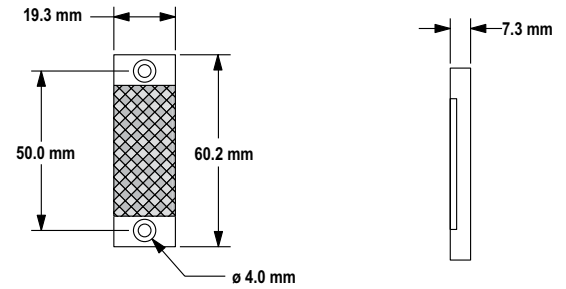

BRT-40X19AM

Description: Rectangular, thin profile acrylic target  
 Reflectivity Factor: 1.2  
 Temperature: -20 to +60 °C  
 Other: This target has micro-prism geometry.

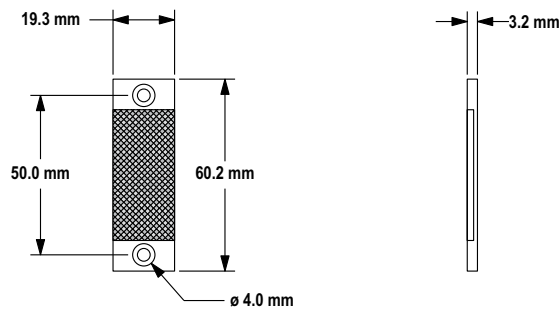

BRT-40X20AM

Description: Rectangular, thin profile acrylic target  
 Reflectivity Factor: 1.2  
 Temperature: -20 to +60 °C  
 Other: This target has micro-prism geometry.

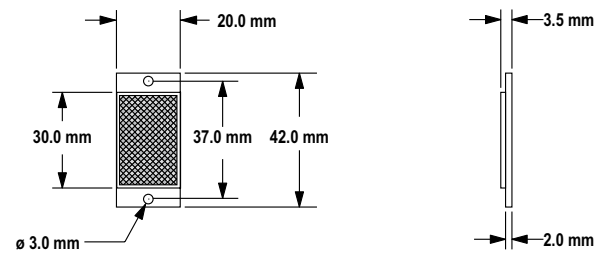

BRT-40X23

Description: Rectangular, acrylic target  
 Reflectivity Factor: 1.4  
 Temperature: -20 to +60 °C



BRT-40X23A

Description: Rectangular, acrylic target  
 Reflectivity Factor: 1.4  
 Max. Temperature: -20 to +60 °C

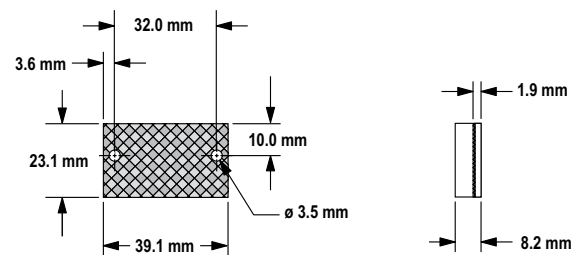

BRT-40X23B

Description: Rectangular, acrylic target  
 Reflectivity Factor: 1.4  
 Max. Temperature: -20 to +60 °C

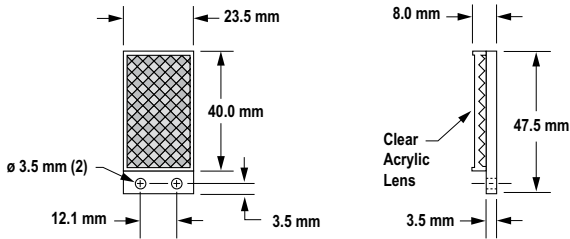

BRT-40X23ABC

Description: Rectangular, acrylic target  
 Reflectivity Factor: 1.4  
 Max. Temperature: 50 °C

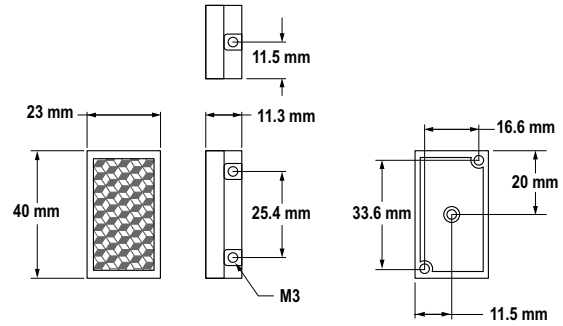

BRT-44X29A6

Description: Rectangular, acrylic target  
 Reflectivity Factor: 1.1  
 Max. Temperature: 50 °C  
 Other: 6 mm facets; close to the face retroreflective sensing with bifurcated lens.

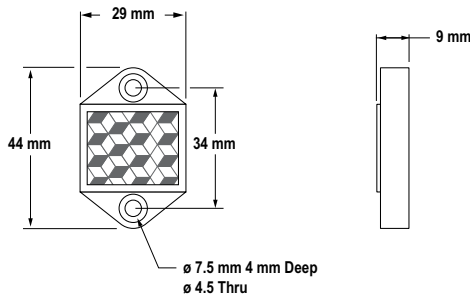

BRT-48X32

Description: Rectangular, acrylic target  
 Reflectivity Factor: 1.0  
 Temperature: -20 to +60 °C

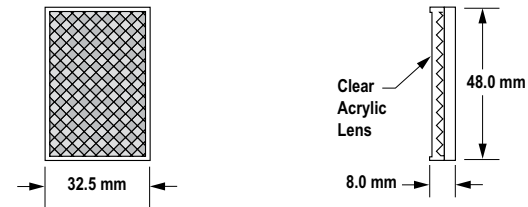

BRT-48X32A

Description: Rectangular, acrylic target  
 Reflectivity Factor: 1.0  
 Temperature: -20 to +60 °C

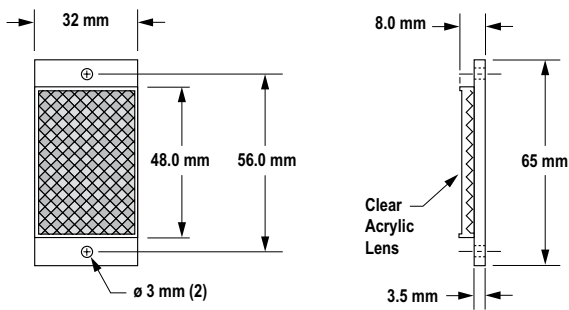

BRT-48X32B

Description: Rectangular, acrylic target  
 Reflectivity Factor: 1.0  
 Temperature: -20 to +60 °C

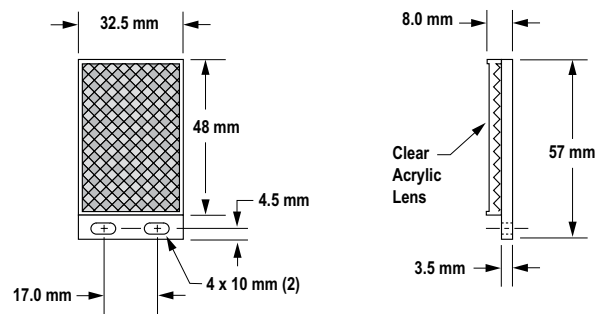



**BRT-53X19A**

Description: Rectangular, acrylic target  
 Reflectivity Factor: 1.4  
 Max. Temperature: -20 to +60 °C

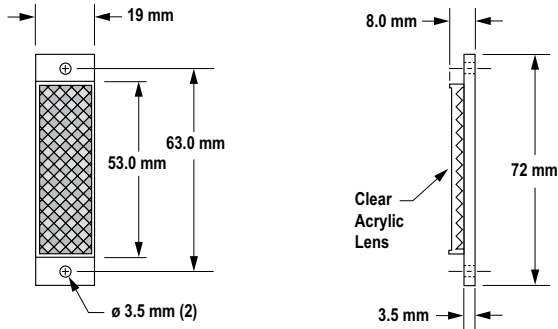

**BRT-60X40AF**

Description: Rectangular, acrylic target  
 Reflectivity Factor: 1.4 Max. Temperature: -20 to +60 °C  
 Other: Anti-fogging coating for use around steam. Optional brackets are available.

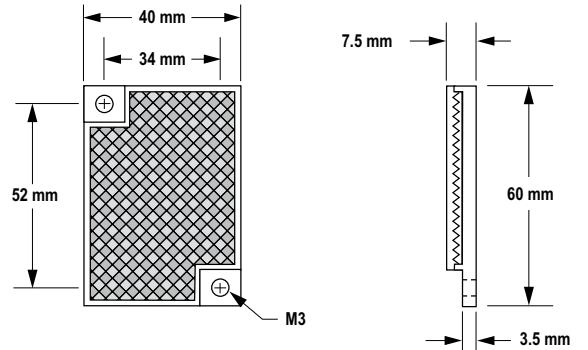

**BRT-60X40C**

Description: Rectangular, acrylic target  
 Reflectivity Factor: 1.4 Max. Temperature: -20 to +60 °C  
 Other: Optional brackets are available.

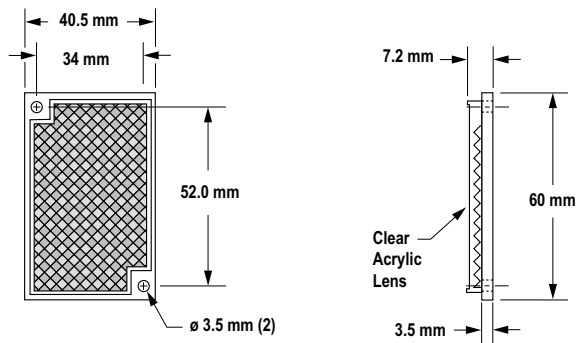

**BRT-60X40IP69K**

Description: Rectangular, acrylic target (color is amber)  
 Reflectivity Factor: 0.7 Max. Temperature: -20 to 60 °C  
 Other: Chemically resistant and IP69K washdown rated. Optional brackets are available

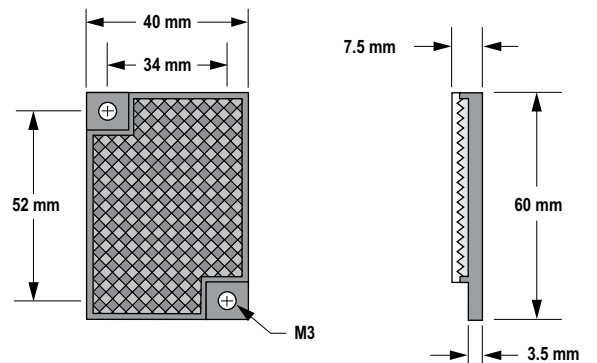

**BRT-62X10AM**

Description: Rectangular, thin profile acrylic target  
 Reflectivity Factor: 1.2  
 Max. Temperature: -20 to +60 °C  
 Other: This target has micro-prism geometry.

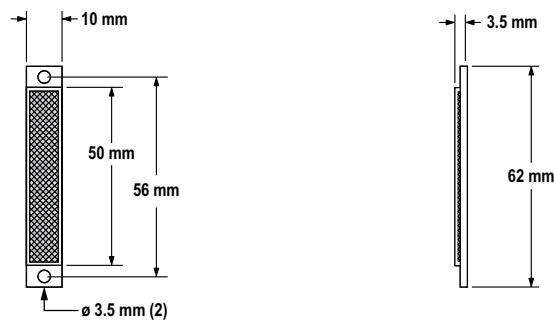

**BRT-80X50C**

Description: Rectangular, acrylic target  
 Reflectivity Factor: 1.4  
 Temperature: -20 to +60 °C

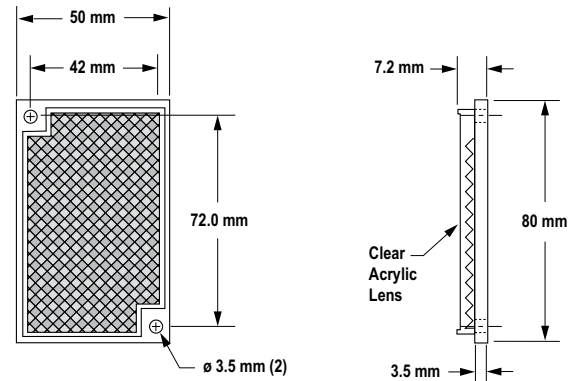

BRT-80X50CM

Description: Rectangular, acrylic target  
 Reflectivity Factor: 1.4  
 Temperature: -20 to +60 °C

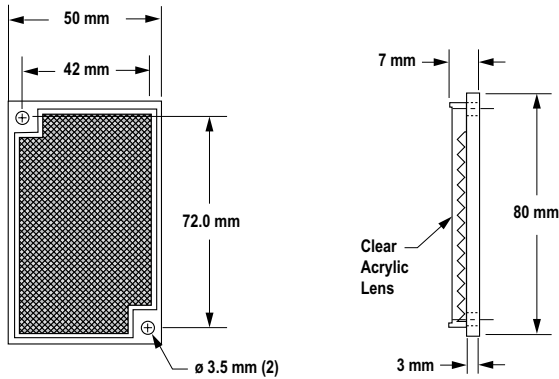

BRT-100X50

Description: Rectangular, acrylic target  
 Reflectivity Factor: 1.5  
 Temperature: -20 to +60 °C

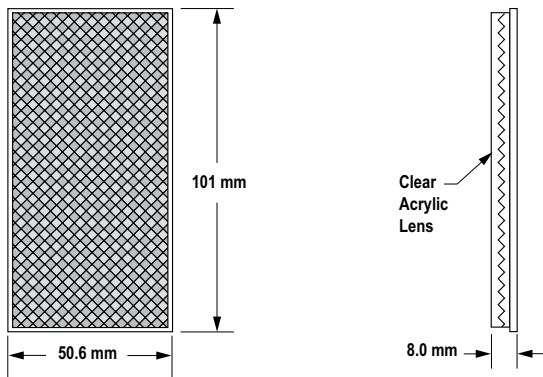

BRT-150X18A

Description: Rectangular, acrylic target  
 Reflectivity Factor: 1.4  
 Temperature: -20 to +60 °C

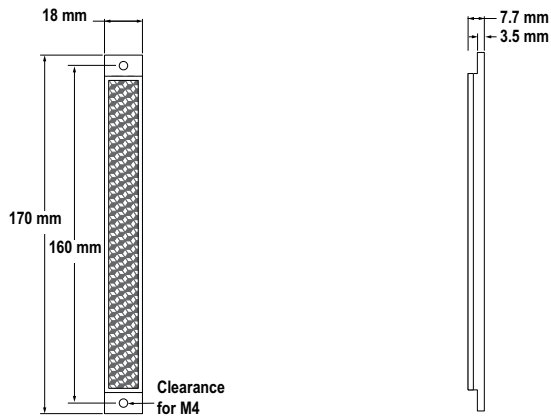

BRT-100X18A

Description: Rectangular, acrylic target  
 Reflectivity Factor: 1.4  
 Temperature: -20 to +60 °C

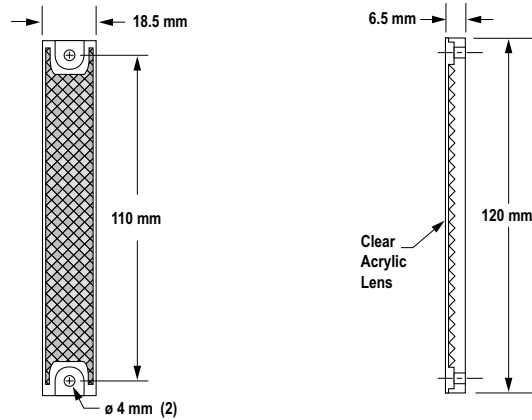

BRT-100X55A

Description: Rectangular, acrylic target  
 Reflectivity Factor: 1.5  
 Temperature: -20 to +60 °C

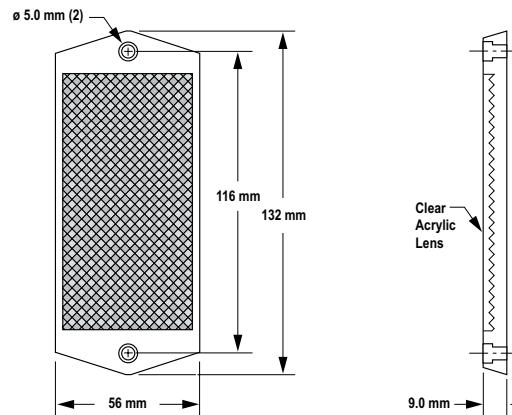

BRT-150X18T

Description: Rectangular, acrylic target includes mounting tape.  
 Reflectivity Factor: 1.4  
 Temperature: -20 to 60 °C

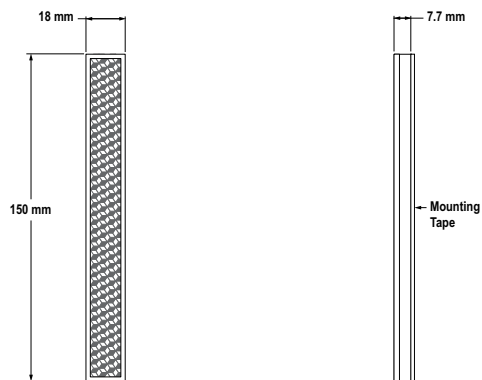

BRT-L

Description: Rectangular, acrylic target  
 Reflectivity Factor: 0.8  
 Max. Temperature: 65 °C

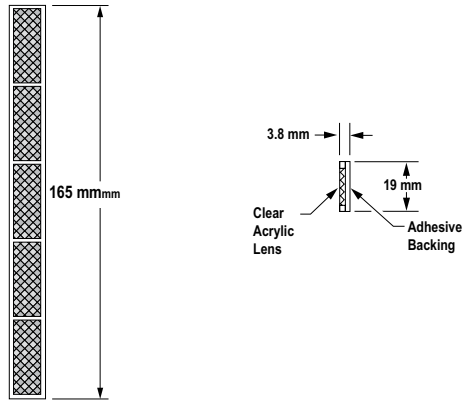

BRT-180X40A

Description: Rectangular, acrylic target  
 Reflectivity Factor: 1.4  
 Temperature: -20 to +60 °C

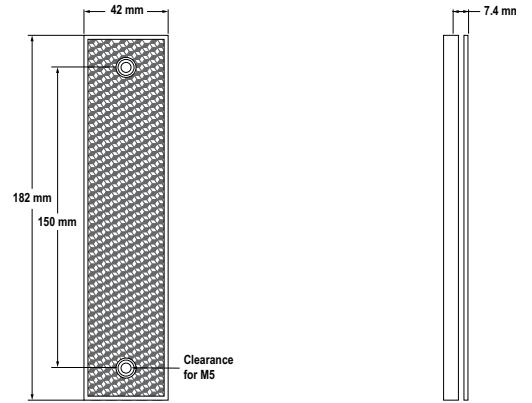

Retroreflective Tape

NOTE: Sensing range and signal strength at any given sensor-to-target distance will vary due to target reflectivity and target area. A "Reflectivity Factor" is included for each target model to help predict sensor performance, relative to the excess gain curve plotted for target model BRT-3. Consider, also, target area when predicting performance. Changing to a high reflectivity reflector (like BRT-92X92C) may also extend sensor range and/or reduce the need for frequent reflector maintenance. A high reflectivity factor AND large surface area are needed for maximum range.

Reflectivity Factor	Maximum Temperature	Size	Model	Unit
0.7	60 °C	75 x 75 mm	BRT-THG-3X3-10	10 per pack
0.7	60 °C	100 x 100 mm	BRT-THG-4X4-5	5 per pack
0.7	60 °C	216 x 280 mm	BRT-THG-8.5X11-2	2 per pack
0.7	60 °C	457 x 914 mm	BRT-THG-18X36	Single sheet
0.7	60 °C	25 mm wide	BRT-THG-1-100	2.5 m length
0.7	60 °C	50 mm wide	BRT-THG-2-100	2.5 m length
0.7	60 °C	75 mm wide	BRT-THG-3-100	2.5 m length
0.07	175 °C	25 mm wide	BRT-THT-100†	2.5 m length
0.2	85 °C	25 mm wide	BRT-T-100CC	2.5 m length
0.8	60 °C	50 x 50 mm	BRT-TVHG-2X2*	4 per pack
0.8	60 °C	203 x 254 mm	BRT-TVHG-8X10P†	1 per pack



NOTE: Retroreflective material has a pressure-sensitive adhesive. For maximum adhesion, surfaces must be clean and dry before applying. For best results, use full size; target may be trimmed as necessary.

† These targets are not recommended for polarized retroreflective sensors.

\* These are sealed micro-prism style pieces and may not be cut.

Suitable for use with Laser sensors, VS3 sensors and SME312LPC model sensors.

Not suggested for close range (less than 102 mm), except with VS3 sensors.

MSA Series Stands

- Supports emitter, receiver or corner mirror
- Available without stand base, for attaching to a surface
- Assembles easily
- Includes mounting hardware
- Provides mounting T-slots with center dimension of 20 mm

Used With**	Stand Height (L)	Usable Stand Length	Model*
EZ-SCREEN, PICO-GUARD Grids/Points, Mirrors, EZ-ARRAY, MINI-ARRAY and High-Resolution MINI-ARRAY	616 mm	483 mm	MSA-S24-1
	1073 mm	940 mm	MSA-S42-1
	1682 mm	1550 mm	MSA-S66-1
	2140 mm	2007 mm	MSA-S84-1
	2673 mm	2667 mm	MSA-S105-1

\* Available without a base by adding suffix NB to model number (example, MSA-S24-1NB).

\*\* Adapter brackets EZA-MBK-2 (2 each) are required for mounting EZ-SCREEN Grid and Point emitters/receivers or SSM Series mirrors (ordered separately).

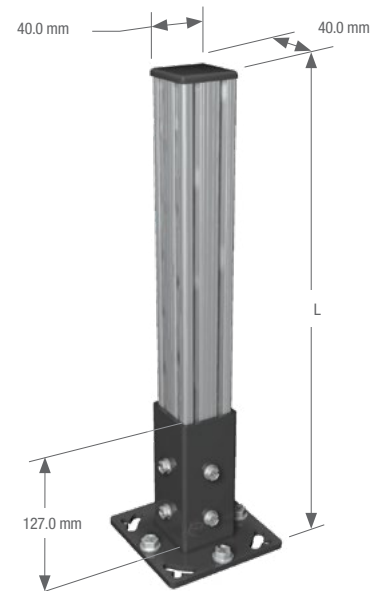

Telescoping Stands for use with Run Bars

- Locates touch buttons 800 to 1232 mm above the floor surface
- Includes swivel-mount bracket to mount Run Bar (Run Bar not included)
- Made of cold-rolled steel; black powdercoat finish

Used with	Description	Model
STBVP6-RB1	Floor-mounted telescoping stand Stationary base with 4 mounting holes in corners	STBA-RB1-S1
STBVP6-RB2		STBA-RB2-S1
STBVP6-RB1	Free-standing, telescoping stand Movable H-shaped floor base with mounting holes 560 mm apart	STBA-RB1-S2
STBVP6-RB2		STBA-RB2-S2



Adjustable Mounting Systems

- Provides flexible mounting and positioning of sensors and lights
- Includes 3" and 6" column mounting kits for mounting area lights and backlights
- Features Bogen Arm and clamp for use with P4 and Pro sensors
- Offers 2" mounting knuckle assembly for spot lights

Used With	Description	Model
Pro P4 Vision Lights	3" Column, Base, and Knuckle Kit	SMBPPK3
	6" Column, Base, and Knuckle Kit	SMBPPK6
	Mounting Bracket Knuckle	SMBPPK
	3" Column	SMBPPKE3
	6" Column	SMBPPKE6
	Mounting Bracket Base	SMBPPKB
	2" Mounting Knuckle Assembly	SMBPPLK
	Bogen Arm with Single Knob	SMBPPF1
	Bogen Arm Clamp	SMBPPFB





Elevated Use—Stand-off Pipe, Brackets and Adapters

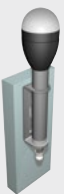

Description	Length	Model	Used With
Thermoplastic Acetal adapter and cover (M30 to 1/2" NPSM/DN15)	—	SA-M30TE12	TL50
Thermoplastic Acetal adapter and cover (M30 to 1/2" NPSM/DN15)	—	SA-M30E12	K50L K80L
Stainless steel pipe (1/2" NPSM/DN15)	150 mm	SOP-E12-150SS	K50L
	300 mm	SOP-E12-300SS	K80L
	900 mm	SOP-E12-900SS	TL50
Anodized aluminum pipe (1/2" NPSM/D15)	150 mm	SOP-E12-150AC	K50L
	300 mm	SOP-E12-300AC	K80L
	900 mm	SOP-E12-900AC	TL50
Black Anodized aluminum pipe (1/2" NPSM/D15)	150 mm	SOP-E12-150A	K50L
	300 mm	SOP-E12-300A	K80L
	900 mm	SOP-E12-900A	TL50
Thermoplastic Acetal mounting base (1/2" NPSM/DN15 to M30)	—	SA-E12M30	K50L, K80L, TL50
Stainless steel bracket for wall or other flat surfaces	—	SMBE12USS	K50L K80L TL50

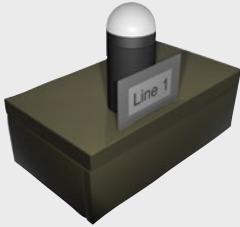

Elevated Use—Enclosure Mounts and Extensions

Description	Length	Model	Used With
 <p>Thermoplastic Acetal standoff with 30 mm mounting base for cabinet mounting or use with most 30 mm brackets</p>	75 mm	SA-M30M30-75	K50L
<p>Zinc coated, oversized right-angle legend plate for identification labels</p>	—	SA-30RL55X93	SA-M30M30-75
 <p>Thermoplastic Acetal standoff with 22.5 mm mounting base for cabinet mounting</p>	50 mm	SA-M22M22-50	K30L

Elevated Use—Hanging Bracket

Description	Length	Model	Used With
 <p>Zinc coated bracket with strain relief for mounting one device</p>	—	SA-30RL55X93C	K50 Push Button VTB
 <p>Zinc coated bracket for mounting two devices</p>	—	SA-30DRL55X93C	Sensors and indicators with 30 mm base or barrel mount

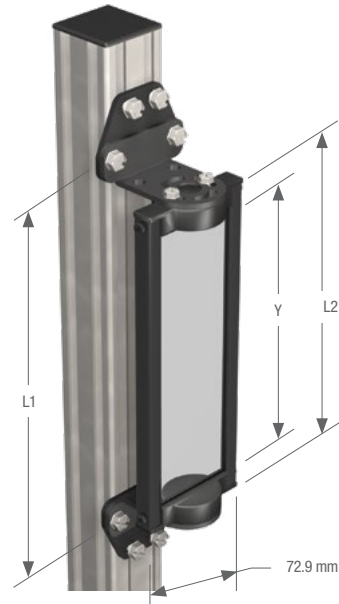

MSM Corner Mirrors  
(shown with standard brackets and MSAMB\*\* adapter bracket mounted on MSA stand)

## MSM Corner Mirrors

- Compact for light-duty applications
- Available in 12 lengths
- Decreases range by 8%
- Rated 85% efficiency

Reflective Area (Y)	Mounting Height (L1)*	Mirror Height (L2)	Model
165 mm	221 mm	191 mm	MSM4A
267 mm	323 mm	292 mm	MSM8A
356 mm	411 mm	381 mm	MSM12A
457 mm	513 mm	483 mm	MSM16A
559 mm	615 mm	584 mm	MSM20A
660 mm	716 mm	686 mm	MSM24A
762 mm	818 mm	787 mm	MSM28A
864 mm	919 mm	889 mm	MSM32A
965 mm	1021 mm	991 mm	MSM36A
1067 mm	1123 mm	1092 mm	MSM40A
1168 mm	1224 mm	1194 mm	MSM44A
1270 mm	1326 mm	1295 mm	MSM48A

\* The mounting brackets may be inverted from the positions shown (flanges pointing "inward" instead of "outward," as shown). When this is done, dimension L1 decreases by 57 mm.

\*\* MSAMB adapter bracket kit included with each MSA stand.



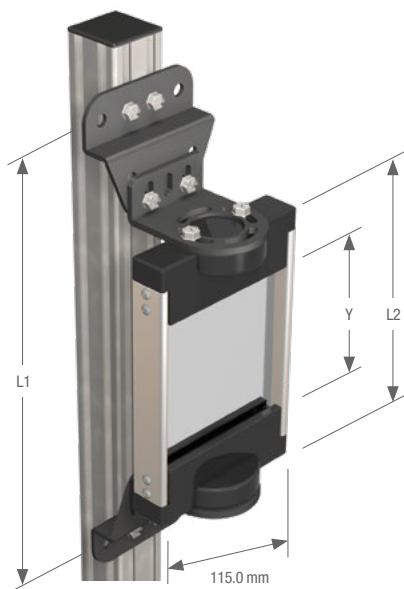

SSM and SSM-S Corner Mirrors  
(shown with standard brackets and EZA-MBK-2\*\*  
adapter bracket mounted on MSA stand)

### SSM Glass Corner Mirrors

- Robust for heavy-duty applications
- Extra wide for use with long-range optical safety systems
- Available in stainless steel for harsh applications
- Available in 20 lengths
- Rated 85% efficiency for SSM models and 50% on SSM-S models
- Decreases range by 8% for SSM models and 30% for SSM-S models

Reflective Area (Y)	Mounting Height (L1)*	Mirror Height (L2)	Glass Models	Stainless Steel Models
100 mm	211 mm	178 mm	SSM-100	SSM-100-S
150 mm	261 mm	228 mm	SSM-150	SSM-150-S
200 mm	311 mm	278 mm	SSM-200	SSM-200-S
250 mm	361 mm	328 mm	SSM-250	SSM-250-S
375 mm	486 mm	453 mm	SSM-375	SSM-375-S
475 mm	586 mm	553 mm	SSM-475	SSM-475-S
550 mm	661 mm	628 mm	SSM-550	SSM-550-S
675 mm	786 mm	753 mm	SSM-675	SSM-675-S
825 mm	936 mm	903 mm	SSM-825	SSM-825-S
875 mm	986 mm	953 mm	SSM-875	SSM-875-S
975 mm	1086 mm	1053 mm	SSM-975	SSM-975-S
1100 mm	1211 mm	1178 mm	SSM-1100	SSM-1100-S
1175 mm	1286 mm	1253 mm	SSM-1175	SSM-1175-S
1275 mm	1386 mm	1353 mm	SSM-1275	SSM-1275-S
1400 mm	1511 mm	1478 mm	SSM-1400	SSM-1400-S
1475 mm	1586 mm	1553 mm	SSM-1475	SSM-1475-S
1550 mm	1661 mm	1628 mm	SSM-1550	SSM-1550-S
1675 mm	1786 mm	1753 mm	SSM-1675	SSM-1675-S
1750 mm	1861 mm	1828 mm	SSM-1750	SSM-1750-S
1900 mm	2011 mm	1978 mm	SSM-1900	SSM-1900-S

\* The mounting brackets may be inverted from the positions shown (flanges pointing "inward" instead of "outward," as shown). When this is done, dimension L1 decreases by 58 mm.

\*\* One EZA-MBK-2 adapter bracket kit required if used with a MSA stand.

NOTE: The total range decreases by approximately 8% per mirror.

Tubular Enclosures

- Available for EZ-ARRAY™, MINI-ARRAY® or EZ-SCREEN® standard 14 & 30 mm
- Ideal for high-pressure washdown environments
- Made of clear FDA-grade polycarbonate tubing, with acetal end caps
- Includes stainless mounting brackets and hardware
- Rated NEMA 4X; IP67

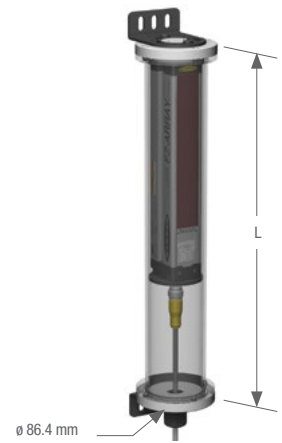

EZA-TE Tubular Enclosures

Emitter/Receiver Model		Used With Emitter/Receiver		
EZ-SCREEN	EZ-ARRAY	Defined Area/Array Length	Enclosure Height (L)	Model
SLS..-150	EA5..-150	150 mm	439 mm	EZA-TE-150
SLS..-300	EA5..-300	300 mm	541 mm	EZA-TE-300
SLS..-450	EA5..-450	450 mm	744 mm	EZA-TE-450
SLS..-600	EA5..-600	600 mm	846 mm	EZA-TE-600
SLS..-750	EA5..-750	750 mm	1024 mm	EZA-TE-750
SLS..-900	EA5..-900	900 mm	1151 mm	EZA-TE-900
SLS..-1050	EA5..-1050	1050 mm	1354 mm	EZA-TE-1050
SLS..-1200	EA5..-1200	1200 mm	1455 mm	EZA-TE-1200
SLS..-1350	—	1350 mm	1608 mm	EZA-TE-1350
SLS..-1500	EA5..-1500	1500 mm	1760 mm	EZA-TE-1500
SLS..-1650	—	1650 mm	1913 mm	EZA-TE-1650
SLS..-1800	EA5..-1800	1800 mm	2065 mm	EZA-TE-1800

NOTE: Use of the enclosure affects the sensing range of the emitter/receiver used: when in pairs, range can be reduced by 50%.

MSA-TE Tubular Enclosures

Emitter/Receiver Model		Used With	Enclosure Height (L)	Model
Emitter/Receiver Model		Emitter/Receiver Array Length	Enclosure Height (L)	Model
MINI-ARRAY	BMEL616A/BMRL616A	201 mm	439 mm	MSA-TE-8
	BMEL632A/BMLR632A			
High-Resolution MINI-ARRAY	MAHE6A/MAHR6A	233 mm		
MINI-ARRAY	BMEL1216A/BMRL1216A	356 mm	541 mm	MSA-TE-12
	BMEL1232A/BMRL1232A	356 mm		
High-Resolution MINI-ARRAY	MAHE13A/MAHR13A	396 mm		
MINI-ARRAY	BMEL1816A/BMRL1816A	505 mm	744 mm	MSA-TE-20
	BMEL1832A/BMRL1832A	505 mm		
High-Resolution MINI-ARRAY	MAHE19A/MAHR19A	559 mm		
MINI-ARRAY	BMEL2416A/BMRL2416A	659 mm	846 mm	MSA-TE-24
	BMEL2432A/BMRL2432A	659 mm		
High-Resolution MINI-ARRAY	MAHE26A/MAHR26A	721 mm	947 mm	MSA-TE-28

NOTE: Use of the enclosure affects the sensing range of the emitter/receiver used: when in pairs, range can be reduced by 50%.

MSA-TE Tubular Enclosures (cont'd)

Used With		Emitter/Receiver Array Length	Enclosure Height (L)	Model
MINI-ARRAY	BMEL3016A/BMRL3016A	810 mm	1049 mm	MSA-TE-32
High-Resolution MINI-ARRAY	BMEL3032A/BMRL3032A			
MINI-ARRAY	MAHE32A/MAHR32A	963 mm	1151 mm	MSA-TE-36
High-Resolution MINI-ARRAY	MAHE38A/MAHR38A			
MINI-ARRAY	BMEL4216A/BMRL4216A	1115 mm	1354 mm	MSA-TE-44
High-Resolution MINI-ARRAY	BMEL4232A/BMRL4232A			
MINI-ARRAY	MAHE45A/MAHR45A	1267 mm	1455 mm	MSA-TE-48
High-Resolution MINI-ARRAY	MAHE51A/MAHR51A			

NOTE: Use of the enclosure affects the sensing range of the emitter/receiver used: when in pairs, range can be reduced by 50%.

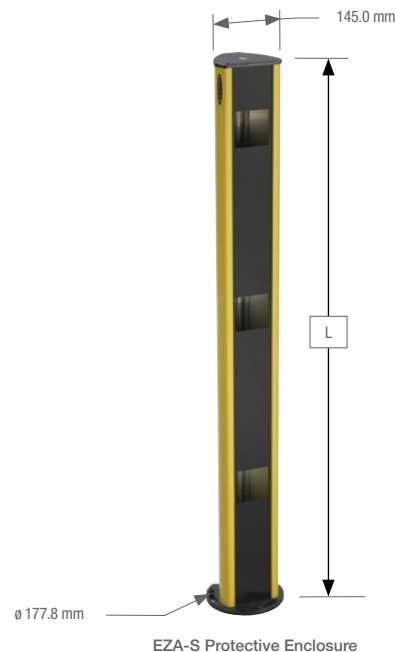

EZA-S Protective Enclosures

- Provide rugged protection for sensors and mirrors in high-traffic areas
- Available for mirrors and EZ-SCREEN® Point and Grid
- Meets ANSI/RIA 15.06 and ISO 13855 standards for beam spacing
- Includes independently adjustable mirrors and bubble level to simplify alignment
- Rotates up to 20°

EZA-S EZ-SCREEN® Protective Enclosures

Used With		Enclosure Height (L)	No. of Openings	Application Standard	Models
SG..4-300	900 mm	1543 mm	4	ANSI/RIA R15.06 ISO 13855	EZA-S300 EZA-S300-M*
SG..3-400	800 mm	1238 mm	3	ANSI/RIA R15.06 ISO 13855	EZA-S400 EZA-S400-M*

Continued on next page

\* Model numbers with suffix **M** include vertical mirrors for perimeter-guarding applications.  
 Model numbers with suffix **M45** include two 45°-mounted mirrors for access-guarding applications.  
 NOTE: The rear-surfaced glass mirrors are rated at 85% efficiency per mirror and reduce maximum range by 8% per mirror.

EZA-S EZ-SCREEN® Protective Enclosures (cont'd)

Used With

Emitter/Receiver Model	Emitter/Receiver Protected Area	Enclosure Height (L)	No. of Openings	Application Standard	Models
SG..2-500	500 mm	1035 mm	2	ISO 13855	EZA-S500 EZA-S500-M*
SP.1	—				EZA-S500-M45*
SG..3-533	1066 mm	1543 mm	3	ANSI/RIA R15.06	EZA-S533 EZA-S533-M*
SG..2-584	584 mm	1238.2 mm	2	ANSI/RIA R15.06	EZA-S584 EZA-S584-M*
SP.1	—				EZA-S584-M45*

\* Model numbers with suffix **M** include vertical mirrors for perimeter-guarding applications.  
 Model numbers with suffix **M45** include two 45°-mounted mirrors for access-guarding applications.  
 NOTE: The rear-surfaced glass mirrors are rated at 85% efficiency per mirror and reduce maximum range by 8% per mirror.

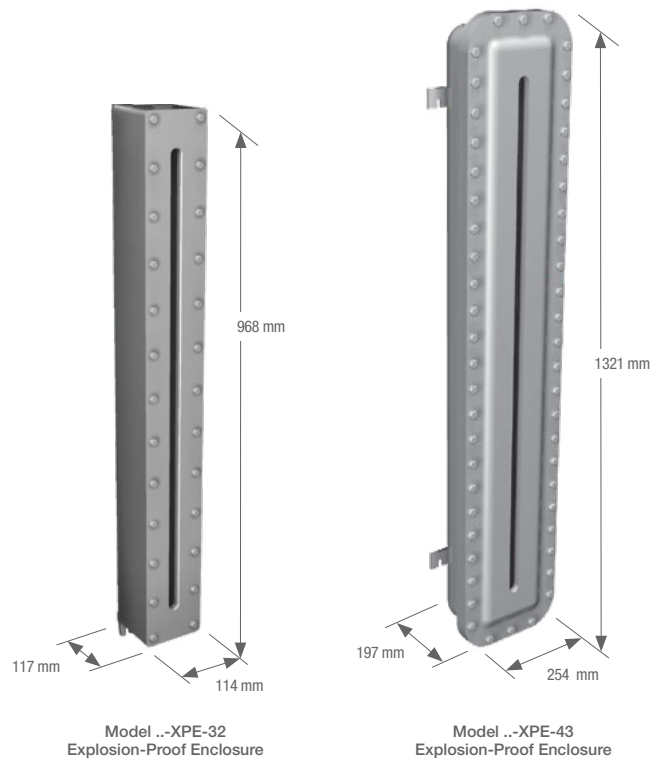

Explosion-Proof Enclosures

- Protects light screen in environments with flammable gases, liquids or dust
- Available for EZ-SCREEN® 14 and 30 resolution models
- Complies with UL and CSA for use in specific hazardous atmospheres
- Includes mounting brackets and hardware
- Reduces range by approximately 25% per emitter/receiver pair

Used With

Model Family	Emitter/Receiver Defined Area	Model
EZ-SCREEN (14 and 30 mm Resolution)	450 to 600 mm	SS-XPE-32
EZ-SCREEN (14 and 30 mm Resolution)	750 to 1050 mm	SS-XPE-43

NOTE: Use of enclosure affects the sensing range of emitter/receiver used: when used in pairs, range can be reduced by 25%.

Heated Enclosures

- Available for MINI-ARRAY® or High-Resolution MINI-ARRAY®
- Protects emitter/receiver in outdoor environments
- Includes humidistat and resistance wires to keep window free of condensation, snow or ice
- Provides choice of stainless steel or aluminum housings

Material	Finish*	Array Length	Overall Enclosure/Height (L)	Clear Window Height	Model
Aluminum	Painted	133 to 1210 mm	1.7 m	1.5 m	BMHE4A/BMHL4G
Aluminum	Painted	1505 to 1514 mm	2.0 m	1.8 m	BMHE5A/BMHL5G
Aluminum	Painted	1810 to 1819 mm	2.2 m	2.0 m	BMHE6A/BMHL6G
Stainless Steel	Painted	133 to 1210 mm	1.7 m	1.5 m	BMHE4SS/BMHL4GSS
Stainless Steel	Painted	1505 to 1514 mm	2.0 m	1.8 m	BMHE5SS/BMHL5GSS
Stainless Steel	Painted	1810 to 1819 mm	2.2 m	2.0 m	BMHE6SS/BMHL6GSS
Stainless Steel	Non-painted	133 to 1210 mm	1.7 m	1.5 m	BMHE4SSN/BMHL4GSSN
Stainless Steel	Non-painted	1505 to 1514 mm	2.0 m	1.8 m	BMHE5SSN/BMHL5GSSN
Stainless Steel	Non-painted	1810 to 1819 mm	2.2 m	2.0 m	BMHE6SSN/BMHL6GSSN

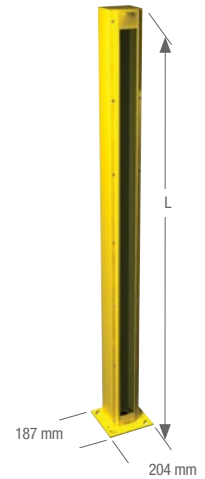

NOTE: Enclosures require a power (see page 819).

\* Standard color is Federal Safety Yellow (Federal Standard color# 23538). Contact Factory for other colors.

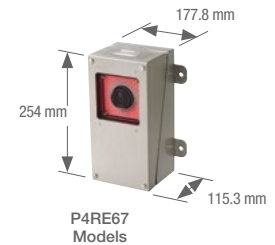
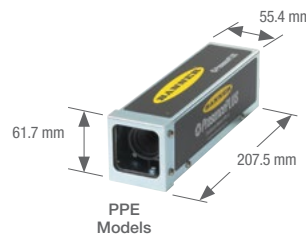
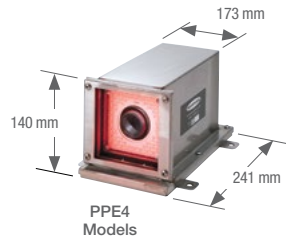

PresencePLUS® Enclosure Kits

- Protects sensor, ring light or both
- Keeps dust and dirt off lens and light
- Prevents accidental bumps and scratches
- Discourages vandalism and tampering
- Helps maintain lens focus by enclosing the lens and sensor
- Available in models that protect camera and light during washdown
- Offers choice of models with glass or plastic viewport

Description	Used With	Model
Heavy-duty stainless-steel enclosure kit—glass viewport; NEMA 6 rated	P4 (right-angle) & Ring Light	P4RE67-G
Heavy-duty stainless-steel enclosure kit—polycarbonate viewport; NEMA 6 rated	P4 (right-angle) & Ring Light	P4RE67-P
Heavy-duty cold-rolled steel industrial protection kit—glass viewport; NEMA 1 rated	Pro Camera & Lens	PPE-G
Heavy-duty cold-rolled steel industrial protection kit—polycarbonate viewport; NEMA 1 rated	Pro Camera & Lens	PPE-P
Replacement viewport—glass	PPE-G	PPE-RG
Replacement viewport—polycarbonate	PPE-P	PPE-RP
Straight Mounting bracket		SMBPPES
Right-angle mounting bracket	PPE-P & PPE-G	SMBPPEA
Front mounting bracket		SMBPPEF
Heavy-duty stainless-steel enclosure kit—glass viewport; NEMA 4 rated	Pro Camera & Ring Light	PPE4-G
Heavy-duty stainless-steel enclosure kit—polycarbonate viewport; NEMA 4 rated	Pro Camera & Ring Light	PPE4-P

Lens Shields

- Covers the lens of the emitter/receiver to prevent damage
- Available for the LX, EZ-ARRAY™, MINI-ARRAY® and EZ-SCREEN®
- Installs easily
- Made of rugged polycarbonate

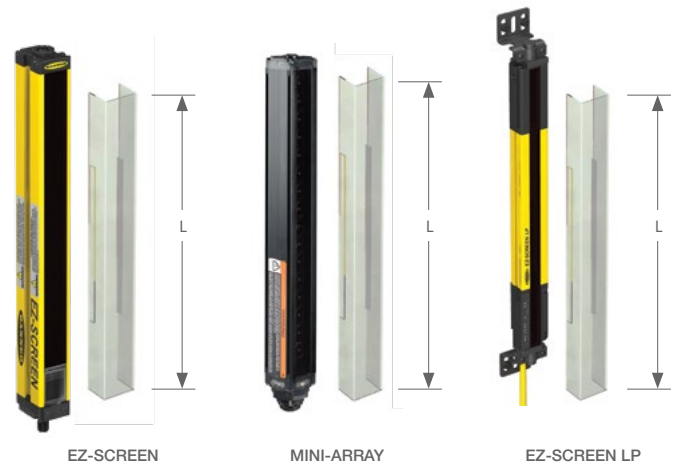

EZ-ARRAY™ & EZ-SCREEN® (14 & 30 mm Resolution) Lens Shields

Installation*	Used With		Defined Area/Array Length	Lens Shield Length (L)	Model
	EZ-ARRAY	EZ-SCREEN			
Adhesive	EA5..150	—	150 mm	218 mm	EZS-150EA
Snap-on				196 mm	EZSS-150EA
Adhesive	—	SLS..-150..	150 mm	258 mm	EZS-150
Snap-on				236 mm	EZSS-150
Adhesive	EA5..300	SLS..-300..	300 mm	368 mm	EZS-300
Snap-on				346 mm	EZSS-300
Adhesive	EA5..450	SLS..-450..	450 mm	518 mm	EZS-450
Snap-on				496 mm	EZSS-450
Adhesive	EA5..600	SLS..-600..	600 mm	667 mm	EZS-600
Snap-on				645 mm	EZSS-600
Adhesive	EA5..750	SLS..-750..	750 mm	817 mm	EZS-750
Snap-on				795 mm	EZSS-750
Adhesive	EA5..900	SLS..-900..	900 mm	967 mm	EZS-900
Snap-on				945 mm	EZSS-900
Adhesive	EA5..1050	SLS..-1050..	1050 mm	1116 mm	EZS-1050
Snap-on				1094 mm	EZSS-1050
Adhesive	EA5..1200	SLS..-1200..	1200 mm	1266 mm	EZS-1200
Snap-on				1244 mm	EZSS-1200
Adhesive	—	SLS..-1350..	1350 mm	1416 mm	EZS-1350
Snap-on				1394 mm	EZSS-1350
Adhesive	—	SLS-1650..	1650 mm	1715 mm	EZS-1650
Snap-on				1693 mm	EZSS-1650
Adhesive	EA5..1500	SLS..-1500..	1500 mm	1565 mm	EZS-1500
Snap-on				1543 mm	EZSS-1500
Adhesive	EA5..1800	SLS..-1800..	1800 mm	1865 mm	EZS-1800
Snap-on				1843 mm	EZSS-1800
Snap-on	EA5..2100	—	2100 mm	2144 mm	EZSS-2100

NOTE: When shields are installed on both the emitter and receiver, maximum operating range is reduced by 20%.

\* Adhesive models are polycarbonate with neoprene gasket. Snap-on models are constructed of copolyester.

## MINI-ARRAY® Lens Shields

Installation	Used With		Array Length	Lens Shield Length (L)*	Model
	Emitter/Receiver Model				
Adhesive	MINI-ARRAY	BMEL1216A/BMRL1216A	286 mm	341 mm	MSS12
		BMEL1232A/BMRL1232A	295 mm		
Adhesive	MINI-ARRAY	BMEL2416A/BMRL2416A	591 mm	643 mm	MSS24
		BMEL2432A/BMRL2432A	600 mm		
Adhesive	MINI-ARRAY	BMEL3616A/BMRL3616A	895 mm	948 mm	MSS36
		BMEL3632A/BMRL3632A	905 mm		
Adhesive	MINI-ARRAY	BMEL4816A/BMRL4816A	1200 mm	1253 mm	MSS48
		BMEL4832A/BMRL4832A	1210 mm		

NOTE: When shields are installed on both the emitter and receiver, maximum operating range is reduced by 20%.

\* Other lens shield lengths are available, contact factory at 1-888-373-6767.

## EZ-SCREEN® LP (14 &amp; 25 mm Resolution) Lens Shields

Installation*	Used With		Lens Shield Length (L)	Model
	Emitter/Receiver Model			
Snap-on	SLP.-270		270 mm	LPSS-270
Snap-on	SLP.-410		410 mm	LPSS-410
Snap-on	SLP.-550		550 mm	LPSS-550
Snap-on	SLP.-690		690 mm	LPSS-690
Snap-on	SLP.-830		830 mm	LPSS-830
Snap-on	SLP.-970		970 mm	LPSS-970
Snap-on	SLP.-1110		1110 mm	LPSS-1110
Snap-on	SLP.-1250		1250 mm	LPSS-1250
Snap-on	SLP.-1390		1390 mm	LPSS-1390
Snap-on	SLP.-1530		1530 mm	LPSS-1530
Snap-on	SLP.-1670		1670 mm	LPSS-1670
Snap-on	SLP.-1810		1810 mm	LPSS-1810

NOTE: When shields are installed on both the emitter and receiver, maximum operating range is reduced by 20%.

\* Adhesive models are polycarbonate with neoprene gasket. Snap-on models are constructed of copolyester.

## EZ-SCREEN® Grids and Points Lens Shields—Adhesive Backed

Type	Lens Shield Length (L)	Emitter/Receiver Model	Emitter/Receiver Protected Height	Model
Point	149 mm	SP..1	—	EZS-149
	684 mm	SG..2-500	500 mm	EZS-684
	768 mm	SG..2-584	584 mm	EZS-768
Grid	984 mm	SG..3-400	800 mm	EZS-984
	1251 mm	SG..3-533	900 mm	EZS-1251
	1084 mm	SG..4-300	1066 mm	EZS-1084

Polycarbonate construction with neoprene gasket

## EZ-SCREEN® Type 2 Lens Shields—Adhesive Backed

Used With			
Emitter/Receive Model	Emitter/Receiver Defined Area	Lens Shield Length (L)	Model
LS2..30-300	300 mm	360 mm	LSS-300
LS2..30-450	450 mm	510 mm	LSS-450
LS2..30-600	600 mm	660 mm	LSS-600
LS2..30-750	750 mm	810 mm	LSS-750
LS2..30-900	900 mm	959 mm	LSS-900
LS2..30-1050	1050 mm	1109 mm	LSS-1050
LS2..30-1200	1200 mm	1558 mm	LSS-1200
LS2..30-1350	1350 mm	1708 mm	LSS-1350
LS2..30-1500	1500 mm	1858 mm	LSS-1500

Polycarbonate construction with neoprene gasket.

## LX Lens Shields

Installation	Used With		Lens Shield Length (L)	Model
	Emitter/Receiver Model	Array Length		
Adhesive	LX3 models	67 mm	98.3 mm	LXS3
	LX6 models	143 mm	174.5 mm	LXS6
	LX12 models	295 mm	326.9 mm	LXS12

NOTE: When shields are installed on both the emitter and receiver, maximum operating range is reduced by 20%.



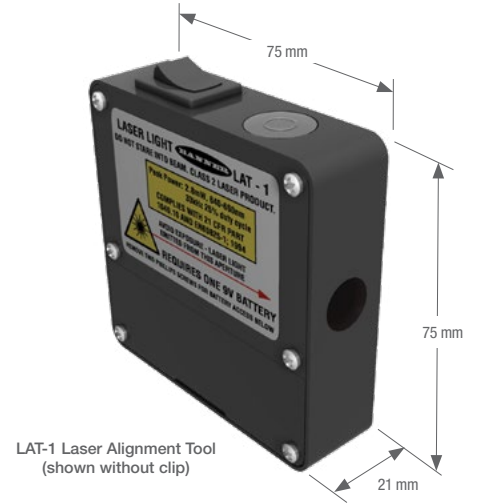
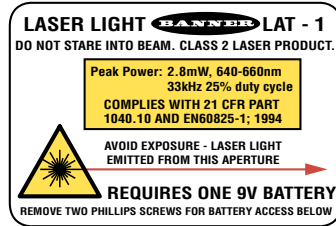



LAT-1 Laser Alignment Tool (shown without clip)

### Laser Alignment Tools

- Simplifies the alignment of any emitter/receiver pair
- Available for EZ-SCREEN®, PICO-GUARD™, LT7, and 18 and 30 mm barrel sensors
- Includes a built-in bubble level
- Uses one 9-volt battery, which is included(some models)

Used With	Supply Voltage	LAT-1 with Clip Kit	Clip w/Target*
EZ-SCREEN Grid or Points and PICO-GUARD Grids	9 V battery for 20 hours of continuous use	LAT-1-HD	EZA-LAT-1
EZ-SCREEN 14 & 30 mm Resolution		LAT-1-SS	EZA-LAT-2
EZ-SCREEN LP 14 & 25 mm Resolution		LAT-1-LP	LPA-LAT-1
EZ-SCREEN Type 2		LAT-1-LS	LSA-LAT-1
EZ-SCREEN Grid or Points, PICO-GUARD Grids, EZ-SCREEN 14 & 30 mm Resolution, EZ-SCREEN LP 14 & 25 mm Resolution and EZ-SCREEN Type 2		LAT-1	-

Description	Used With	Supply Voltage	Model
 <p>LAT-2 shown with LT7</p> <ul style="list-style-type: none"> <li>• Allows for long distance alignment greater than 50 m</li> <li>• Clip-on attachment for sensor</li> </ul>	LT7	—	LAT-2
 <ul style="list-style-type: none"> <li>• Enables easy sensor alignment at long distances</li> <li>• Kit includes one SMB1812 bracket and M12 laser emitter (Class 2 visible red laser)</li> <li>• Clip-on attachment for 18 mm threaded barrel sensors</li> </ul>	18 mm threaded barrel sensors	10 to 30V dc	LAT1812
 <ul style="list-style-type: none"> <li>• Enables easy sensor alignment at long distances</li> <li>• Kit includes one SMB3012 bracket and M12 laser emitter (Class 2 visible red laser)</li> <li>• Clip-on attachment for 30 mm threaded barrel sensors</li> </ul>	30 mm threaded barrel sensors	10 to 30V dc	LAT3012

\* LAT-1 purchased separately.

### BEAM-TRACKER™ Alignment Tool

The BEAM-TRACKER is a low-cost, wireless, battery-operated and completely self-contained photoelectric diagnostic sensor. It is a quick and simple way to evaluate photoelectric system performance. It receives light from all modulated photoelectric emitters and transmits light to receivers to check the system operation. It has a built-in frequency emitter that will be detected by any Banner photoelectric receiver, as well as by those of most other photoelectric manufacturers. It is a valuable tool for locating the center of the beam when installing long-range opposed-mode photoelectric sensor pairs and for locating sources of severe EMI and RFI noise.



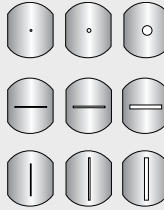
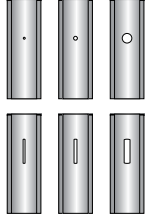
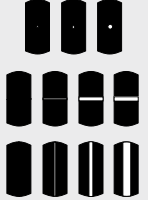

	Supply Voltage	Beam	Construction	Model
	9 V battery for 10 hours of continuous use	70 kHz infrared	Cyclocac® T case	BT-1

### Apertures and Aperture Kits

Opposed-mode sensors may be fitted with apertures which narrow or shape the effective beam of the sensor to more closely match the size of profile of the object to be sensed. A common example is the use of "line" or "slit" type aperture when wire or thread is being sensed.

Aperture Description	Units	Model	Product	Used With
Circular, 0.5 mm dia.	6	APQS18-020		QS18 Opposed-mode
Circular, 1.0 mm dia.	6	APQS18-040		
Circular, 2.5 mm dia.	6	APQS18-100		
Horizontal, slotted, 0.5 x 6.4 mm	6	APQS18-020H		
Horizontal, slotted, 1.0 x 6.4 mm	6	APQS18-040H		
Horizontal, slotted, 2.5 x 6.4 mm	6	APQS18-100H		
Vertical, slotted, 0.5 x 12.7 mm	6	APQS18-020V		
Vertical, slotted, 1.0 x 12.7 mm	6	APQS18-040V		
Vertical, slotted, 2.5 x 12.7 mm	6	APQS18-100V		
Kit with 2 of each aperture	18	APQS18-DVHX2		
Circular, 0.5 mm dia.	2	APQ20-0.5		Q20 Opposed-mode
Circular, 1 mm dia.	2	APQ20-1		
Circular, 2 mm dia.	2	APQ20-2		
Vertical, slotted, 0.5 mm	2	APQ20-0.5V		
Vertical, slotted, 1 mm	2	APQ20-1V		
Vertical, slotted, 2 mm	2	APQ20-2V		
Kit with 2 of each aperture	12	APK-Q20		
Circular, 0.5 mm dia.	20	AP31-020		MINI-BEAM Opposed-mode
Circular, 1.0 mm dia.	20	AP31-040		
Circular, 2.5 mm dia.	20	AP31-100		
Horizontal, slotted, 0.5 x 6.4 mm	20	AP31-020H		
Horizontal, slotted, 1.0 x 6.4 mm	20	AP31-040H		
Horizontal, slotted, 2.5 x 6.4 mm	20	AP31-100H		
Horizontal, slotted, 5.1 x 6.4 mm	20	AP31-200H		
Vertical, slotted, 0.5 x 12.7 mm	20	AP31-020V		
Vertical, slotted, 1.0 x 12.7 mm	20	AP31-040V		
Vertical, slotted, 2.5 x 12.7 mm	20	AP31-100V		
Vertical, slotted, 5.1 x 12.7 mm	20	AP31-200V		
Kit with 2 of each aperture	22	AP31-DVHX2		

Apertures and Aperture Kits (cont'd)

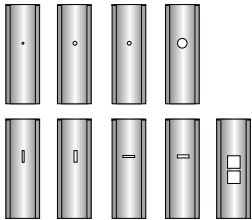
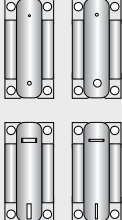
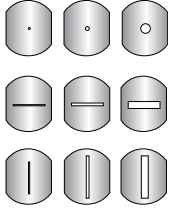
Aperture Description	Units	Model	Product	Used With
Kit includes 3 round apertures of: 0.5, 1.0 & 2.5 mm dia.	3	AP18SC*		S18 & M18
Kit includes 3 rectangular apertures of: 0.5, 1.0 & 2.5 mm dia.	3	AP18SR*		S18 & M18
Kit includes 3 round apertures of: 0.5, 1.0 & 2.5 mm dia.	3	AP18SCN*		T18 & TM18
Kit includes 3 rectangular apertures of: 0.5, 1.0 & 2.5 mm dia.	3	AP18SRN*		T18 & TM18
* Kits include Teflon® FEP® lens, o-ring and thread-on housing.				
Kit with glass lens to protect plastic sensor lens from chemical environments	1	APG18S		S18, M18, T18 & TM18
Circular, 0.5 mm dia.	10	APQ12-.5		Q12 Opposed-mode
Circular, 1.0 mm dia.	10	APQ12-1		
Circular, 1.5 mm dia.	10	APQ12-1.5		
Circular, 2.0 mm dia.	10	APQ12-2		
Horizontal, slotted, 0.5 mm dia.	10	APQ12-.5H		
Horizontal, slotted, 1.0 mm dia.	10	APQ12-1H		
Vertical, slotted, 0.5 mm dia.	10	APQ12-.5V		
Vertical, slotted, 1.0 mm dia.	10	APQ12-1V		
Protective jacket, 4 mm square	10	APQ12-4S		
Kit containing 2 of each aperture	18	APKQ12		
Circular, 2 openings, 0.5 & 1.0 mm dia.	2	APVS2-0204		VS2 Opposed-mode
Circular, 2 openings, 1.5 and 2.0 mm dia.	2	APVS2-0608		
Horizontal (1) and vertical (1), slotted, 0.5 mm wide	2	APVS2-02R		
Horizontal (1) and vertical (1), slotted, 1.0 mm wide	2	APVS2-04R		
Circular, 1.0 mm dia.	6	APQS30-040		QS30 Opposed-mode
Circular, 2.5 mm dia.	6	APQS30-100		
Circular, 5 mm dia.	6	APQS30-200		
Horizontal, slotted, 1 x 12 mm	6	APQS30-040H		
Horizontal, slotted, 2.5 x 12 mm	6	APQS30-100H		
Horizontal, slotted, 5 x 12 mm	6	APQS30-200H		
Vertical, slotted, 1 x 17 mm	6	APQS30-040V		
Vertical, slotted, 2.5 x 17 mm	6	APQS30-100V		
Vertical, slotted, 5 x 17 mm	6	APQS30-200V		
Kit with 2 of each aperture	18	APQS30-DVHX2		

\* Teflon® is a registered trademark of Dupont™.

Ultrasonic Wave Guides

Guide attaches to 18 mm threaded barrel of ultrasonic sensors to focus ultrasonic sensing beam.



Size	Style	Model	Used With
5.0 mm inside dia.	Barrel	UWG18-5.0	QS18U S18U
6.4 mm inside dia.	Barrel	UWG18-6.4	

## Replacement Lens Assemblies

Lens assemblies are field-replaceable. In addition, some lenses may be used to convert from one sensing mode to another, or to change the sensing range of a particular sensor. The possible conversions are listed in the table below.

Replacement Lens for	Possible Sensing Mode or Range Changes	Model	Used With
LVAG	Change LV to LVAG	UC-300AG	MINI-BEAM
W and DBZ	Change D to DBZ and F to DBZ	UC-300BZ	
C, CV and CVG	Change CV2 to CV	UC-300C.7	
C2 and CV2	Change CV to CV2	UC-300C2	
E and R	—	UC-300E	
EL and RL	Extend range of E/R	UC-300EL	
EPD	—	UC-300EPD	
F and FV	Change D to F and DBZ to F	UC-300F	
FP (old style)	—	UC-300FP	
FP	—	UC-300FP2	
LV and D	Change F to D, LVAG to LV and DBZ to D	UC-300L	
LP	—	UC-300LP	
RPD	—	UC-300RPD	
E, R, DL, DX and LV		UC-45L	
LL		UC-45LL	
LLP		UC-45LLP	
LP		UC-45LP	
D	N/A	UC-45D	
F and FV		UC-45F	
FP		UC-45FP	
CV		UC-45C	
CV4		UC-45C4	

## Portable Demo Box

The Portable Demo Box is used to power dc self-contained photoelectric sensors for testing purposes. It is battery-powered and features bicolor LEDs which indicate sensor output status and output type (NPN or PNP). It is designed for a 4-pin Euro-style connector, but cable adapters are available to convert to Pico-style or Mini-style connectors. A 4-pin wiring barrier is mounted on the top of the box to allow connection of cabled dc sensors.



Supply Voltage	Cable Type	Model	Cable Adapters
3 - 9 V battery	4-pin Euro	DBQ5	Euro-to-Pico p/n 39536  Euro-to-Mini p/n 39537

### Test Power Supply

Test power supply is a 1 amp power supply used to power P4 sensors and lighting for proving an application without integration into a control panel.



Input	Input	Trigger Option	Model	Used With
100-240 V ac	North America (AC plug)	<ul style="list-style-type: none"> <li>• 24 V dc NPN Sensor</li> <li>• Continuous pulse</li> <li>• Single pulse</li> </ul>	<b>P4D1</b>	P4 Vision Lighting

### A-GAGE® MINI-ARRAY® Series Power Supplies for Heated Enclosures



Used With	Primary	Secondary	Models
Two BMHE4 Enclosures	105 to 130 V ac	23 V ac	<b>BMHPS4</b>
Two BMHE5 Enclosures	105 to 130 V ac	27 V ac	<b>BMHPS5</b>
Two BMHE6 Enclosures	105 to 130 V ac	35 V ac	<b>BMHPS6</b>
One BMHE4 Enclosure	105 to 130 V ac	23 V ac	<b>BMHPS14</b>
One BMHE5 Enclosure	105 to 130 V ac	27 V ac	<b>BMHPS15</b>
One BMHE6 Enclosure	105 to 130 V ac	35 V ac	<b>BMHPS16</b>

### Continuous Power Supplies

12 or 24V dc power supplies provide power to dc sensors, safety products and specialty lights.



Input	Input Cord	Outputs	Output Cable	Model	Used With
100-240 V ac 50/60 Hz	—	24 V dc @ 4 A max.	—	<b>PSDINA-24-4</b> (DIN-rail mountable)	dc Sensors Vision Lights



115/230 V ac, 50-60 Hz	—	24 V dc (22.5-28.5 V dc adj.) @ 2.5 A (60 W)	—	<b>PSDINA-24*</b> (DIN-rail mountable)	Safety products requiring a SELV rating (EN 60950)
---------------------------	---	--	---	---	--

\* These products are not stocked and are non-returnable.

### USB Serial Adapter



Description	Power	Model	Used With
USB to RS-485 serial adapter with integral communication cordset and USB cable for advanced configuration with a PC.	USB Cable	<b>EZA-USB485-01</b>	EZ-ARRAY





USB to RS-485 serial adapter with integral communication cordset and USB cable for easy configuration of a single sensor or a network of sensors.	USB Cable	<b>INTUSB485-LH</b>	LH
---	-----------	---------------------	----



USB to RS-485 serial adapter for advanced configuration with a PC. NOTE: Communication cordset ordered separately.	USB Cable	<b>INTUSB485-1</b>	EZ-ARRAY
---	-----------	--------------------	----------



### Power Supplies and Interface Modules

The power supplies provide a low-cost interface between ac power supply and dc-operated sensors. They can source up to 100 milliamps. All models are available with integral TEACH push button and remote TEACH function. The interface module is a passive module that allows additional status indicators to be located in the user's control cabinet. It provides remote indication and TEACH capability.

Description	Sensor Input	Input Supply	Sensor Supply	Models
 <p>Power Supply e/m relay output, status lights, and TEACH button</p>	NPN	24 V ac	15 V dc	PS24-1N
	PNP			PS24-1P
	NPN	115 V ac		PS115-1N
	PNP			PS115-1P
 <p>Passive Interface Module Status lights and TEACH button</p>	—	10-30V dc	—	SIM-525T

### Sensor Interface Modules

Low-cost modules provide a dc powered interface for sensors.

Input	Outputs	Connections	Model	Used With
 <p>10-30 V dc</p>	Current Sinking (NPN)	Two 13-pin Terminals	PPSIM-NT	PresencePLUS P4
		One 13-pin Terminals One DB-15 Connector	PPSIM-NC	
	Current Sourcing (PNP)	Two 13-pin Terminals	PPSIM-PT	
		One 13-pin Terminals One DB-15 Connector	PPSIM-PC	
 <p>10-30 V dc</p>	Current Sinking (NPN)/ Current Sourcing (PNP)	Two 13-pin Terminals	IVUSIM	iVu

### Light Interface Modules

Low-cost interface module allows strobe operation of Banner vision lighting with any vision sensor or system.

Input	Strobe Output	Model	Used With
 <p>24 V dc</p>	5 V @ 10 mA max.	PPLIM	Vision lighting

### EZ-LIGHT™ Controllers

- Manually operated controllers for Andon, call-for-parts and machine status indication
- Toggle switch model can control up to 5 indicators simultaneously

Description	Switch Function	Supply Voltage	Model	Used With
 <p>5 toggle switches</p> <p>12-position rotary switch</p>	ON-OFF-FLASH	30 V dc	LC80T	EZ-LIGHT indicators with PNP input
			LC80R	

AC Emitter/Receiver Interface Boxes

- Provides AC power for up to three receivers or two cascaded emitter/receiver pairs, with external device monitoring (EDM) available
- Supplies +24V dc power at 0.7 amps (16.8 W max. power) and accepts input voltages from 100-250V ac (50-60 Hz)



Safety Outputs	EDM	Emitter/Receiver Connection	AC Power Connection	Output and EDM Connections	Model	Used with
3 NO 2 NO & 1 NC	Selectable 1- or 2-Channel or no EDM	8-Pin M12/Euro QD	Hard-wired	Hard-wired	<b>EZAC-R9-QE8</b>	EZ-SCREEN
			Hard-wired	Hard-wired	<b>EZAC-R11-QE8</b>	
1 NO & 1 SPDT	1-Channel	8-Pin M12/Euro QD	3-Pin Mini QD	8-Pin Mini QD	<b>EZAC-R15A-QE8-QS83</b>	EZ-SCREEN
1 NO & 1 NC	Power Monitoring	8-Pin M12/Euro QD	3-Pin Mini QD	5-Pin Mini QD	<b>EZAC-R8N-QE8-QS53</b>	EZ-SCREEN
2 NO			3-Pin Mini QD	5-Pin Mini QD	<b>EZAC-R10N-QE8-QS53</b>	

AC Emitter Interface Boxes

- Provides AC power for up to four emitters, with external device monitoring (EDM) available
- Supplies +24V dc power at 0.7 amps (16.8 W max. power) and accepts input voltages from 100-250V ac (50-60 Hz)



Emitter Connection	AC Power Connection	Model	Used with
8-Pin M12/Euro QD	Hard-wired	<b>EZAC-E-QE8</b>	<ul style="list-style-type: none"> <li>• EZ-SCREEN SLSE...Q8 (without Test input)</li> <li>• EZ-SCREEN SLPE..</li> </ul>
5-Pin M12/Euro QD	Hard-wired	<b>EZAC-E-QE5</b>	<ul style="list-style-type: none"> <li>• EZ-SCREEN SLSE...Q5 (with Test input)</li> </ul>
8-Pin M12/Euro QD	3-Pin Mini QD	<b>EZAC-E-QE8-QS3</b>	<ul style="list-style-type: none"> <li>• EZ-SCREEN SLSE...Q8 (without Test input)</li> <li>• EZ-SCREEN SLPE..</li> </ul>
5-Pin M12/Euro QD	5-Pin Mini QD	<b>EZAC-E-QE5-QS5</b>	<ul style="list-style-type: none"> <li>• EZ-SCREEN SLSE...Q5 (with Test input)</li> </ul>

NC = Normally Closed, NO = Normally Open

AC Interface Box Specifications



Important Notice:

European Community Machinery Directive 2006/42/EC

The EZ-SCREEN EZAC- Interface Boxes comply with Machinery Directive 98/37/EC, but not with Machinery Directive 2006/42/EC. Therefore, these Interface Boxes can only be installed as a replacement component within the European Union (EU). For more information, please see [www.bannerengineering.com/144763](http://www.bannerengineering.com/144763) or call 1-888-373-6767.

## Mechanically Linked Contactors\*

Provides an additional 10 or 18 amp carrying capability to any safety system.

	Coil Voltage	Contacts	Contact Rating	Dimensions (h x w x l)	Model	Used With
	120 V ac	3 NO & 1 NC	10 amps	57 x 44 x 58 mm	11-BG00-31-A12060	<ul style="list-style-type: none"> <li>EZ-SCREEN</li> <li>SC22-3/-3E</li> </ul>
	24 V dc		10 amps (thermal)	57 x 44 x 58 mm	11-BG00-31-D-024	
	120 V ac	3 NO & 1 NC	18 amps**	80 x 44 x 80 mm	BF1801A-12060	
	24 V dc		18 amps** (inductive)	80 x 44 x 80 mm	BF1801L-024	

NC = Normally Closed, NO = Normally Open, minimum switching current (power): 5 mA @ 17 V dc (85 mw)

\* One Arc Suppressor is needed for each relay across the coil (see below).

\*\* NC contact is rated at 10 amps

## Auxiliary Contacts for Mechanically Linked Contactors



Adds contacts to mechanically linked contactors.

	Contacts	Positively Guided	Model	Used With
	4 NO	No (Aux. only)	11-BGX10-40	11-BG Series
	3 NO	Yes	11-G484-30	BF Series

NC = Normally Closed, NO = Normally Open

## Suppressors for Mechanically Linked Contactors

Extends the life of the actuating device—such as a light screen or control module—that uses a mechanically linked contactor.

	Voltage	Model	Used With
	48V dc	11-BGX77-048	11-BG00-31-D024
	125-240V ac	11-BGX77-240	11-BG00-31-A12060
	48V dc	11-G318-48	BF1801L-024
	125-240V ac	BFX77-240	BF1801A-12060

NC = Normally Closed, NO = Normally Open



Lighting & Indicators



Models

- LED Lighting
- Tower Lights
- Base Mount
- T-Style Mount
- Barrel Mount
- Flat Mount
- Indicators for Safety devices

See page 380

Indicator Lamps

- Indicates whether a switch is open or closed
- Available in red or green, 120 V ac or 24 V ac/dc



Supply Voltage	Lamp Color	Thread	Models	Used With
24 V ac/dc	Red	M20 x 1.5	SI-PL3T-R	<ul style="list-style-type: none"> <li>• SI-QS90 Safety Interlock Switches</li> <li>• SI-LS42 Safety Interlock Switches</li> <li>• SI-QM100 Safety Interlock Switches</li> <li>• RP-LS42 Rope Pull Switches</li> <li>• RP-QM72/QMT72 Rope Pull Switches</li> <li>• RP-RM83 Rope Pull Switches</li> <li>• RP-QM90 Rope Pull Switch</li> </ul>
120 V ac			SI-PL3A-R	
24 V ac/dc	Green	M20 x 1.5	SI-PL3T-G	
120 V ac			SI-PL3A-G	

Muting Lamps

- Indicates when muting is active for optical safety systems with a muting module
- Uses a solid-state LEDs light, eliminating the need to replace bulbs

Supply Voltage	Lamp Color	Overall Height	Models	Used with
18-30 V dc or 24 V ac	Green, Yellow, Red, White	142.6 mm	TL50GYRWQ	<ul style="list-style-type: none"> <li>• EZ-SCREEN</li> <li>• Muting Modules</li> </ul>
	Yellow	61.2 mm	TL50YQ	
	White		TL50WQ	
+24 V dc	Red, Green, Yellow (Amber)	ø 18 mm	M18RGR5PNQ	
12-30 V dc	Green, Red, White	58 mm	K50LGRW2PQ-18886	
12-30 V dc	White	58 mm	K50LWXXPQ	
12-30 V dc	Yellow	58 mm	K50LYXXPQ	

# English-Metric Conversion

Inch Fraction	Inch Decimal	Millimeter	Inch Fraction	Inch Decimal	Millimeter	Inch Fraction	Inch Decimal	Millimeter
—	.0039	0.1	9/32	.2812	7.144	21/32	.6562	16.669
—	.0079	0.2	19/64	.2969	7.541	—	.6693	17
—	.0118	0.3	5/16	.3125	7.938	43/64	.6719	17.066
1/64	.0156	0.397	—	.3150	8	11/16	.6875	17.462
—	.0157	0.4	21/64	.3281	8.334	45/64	.7031	17.859
—	.0197	0.5	11/32	.3438	8.731	—	.7087	18
—	.0236	0.6	—	.3543	9	23/32	.7188	18.256
—	.0276	0.7	23/64	.3594	9.128	47/64	.7344	18.653
1/32	.0312	0.794	3/8	.375	9.525	—	.7480	19
—	.0315	0.8	25/64	.3906	9.922	3/4	.750	19.050
—	.0354	0.9	—	.3937	10	49/64	.7656	19.447
—	.0394	1	13/32	.4062	10.319	25/32	.7812	19.844
3/64	.0469	1.191	27/64	.4219	10.716	—	.7874	20
1/16	.0625	1.588	—	.4331	11	51/64	.7969	20.241
5/64	.0781	1.984	7/16	.4375	11.112	13/16	.8125	20.638
—	.0787	2	29/64	.4531	11.509	—	.8268	21
3/32	.0938	2.381	15/32	.4688	11.906	53/64	.8281	21.034
7/64	.1094	2.778	—	.4724	12	27/32	.8438	21.431
—	.1181	3	31/64	.4844	12.303	55/64	.8594	21.828
1/8	.1250	3.175	1/2	.500	12.700	—	.8661	22
9/64	.1406	3.572	—	.5118	13	7/8	.875	22.225
5/32	.1562	3.969	33/64	.5156	13.097	57/64	.8906	22.622
—	.1575	4	17/32	.5312	13.494	—	.9055	23
11/64	.1719	4.366	35/64	.5469	13.891	29/32	.9062	23.019
3/16	.1875	4.762	—	.5512	14	59/64	.9219	23.416
—	.1968	5	9/16	.5625	14.288	15/16	.9375	23.812
13/64	.2031	5.159	37/64	.5781	14.684	—	.9449	24
7/32	.2188	5.556	—	.5905	15	61/64	.9531	24.209
15/64	.2344	5.953	19/32	.5938	15.081	31/32	.9688	24.606
—	.2362	6	39/64	.6094	15.478	—	.9842	25
1/4	.2500	6.350	5/8	.625	15.875	63/64	.9844	25.003
17/64	.2656	6.747	—	.6299	16	1	1.000	25.400
—	.2756	7	41/64	.6406	16.272	—	—	—

To convert millimeters to inches, multiply by 0.0394.

To convert inches to millimeters, multiply by 25.4.

# Temperature Conversion

Celsius°	Fahrenheit°	Celsius°	Fahrenheit°	Celsius°	Fahrenheit°
-62	-80	0.0	32	22.2	72
-57	-70	0.6	33	22.8	73
-51	-60	1.1	34	23.3	74
-46	-50	1.7	35	23.9	75
-40	-40	2.2	36	24.4	76
-34	-30	2.8	37	25.0	77
-29	-20	3.3	38	25.6	78
-23	-10	3.9	39	26.1	79
-17.8	0	4.4	40	26.7	80
-17.2	1	5.0	41	27.2	81
-16.7	2	5.6	42	27.8	82
-16.1	3	6.1	43	28.3	83
-15.6	4	6.7	44	28.9	84
-15.0	5	7.2	45	29.4	85
-14.4	6	7.8	46	30.0	86
-13.9	7	8.3	47	30.6	87
-13.3	8	8.9	48	31.1	88
-12.8	9	9.4	49	31.7	89
-12.2	10	10.0	50	32.2	90
-11.7	11	10.6	51	32.8	91
-11.1	12	11.1	52	33.3	92
-10.6	13	11.7	53	33.9	93
-10.0	14	12.2	54	34.4	94
-9.4	15	12.8	55	35.0	95
-8.9	16	13.3	56	35.6	96
-8.3	17	13.9	57	36.1	97
-7.8	18	14.4	58	36.7	98
-7.2	19	15.0	59	37.2	99
-6.7	20	15.6	60	37.8	100
-6.1	21	16.1	61	43	110
-5.6	22	16.7	62	49	120
-5.0	23	17.2	63	54	130
-4.4	24	17.8	64	60	140
-3.9	25	18.3	65	66	150
-3.3	26	18.9	66	71	160
-2.8	27	19.4	67	77	170
-2.2	28	20.0	68	82	180
-1.7	29	20.6	69	88	190
-1.1	30	21.1	70	93	200
-0.6	31	21.7	71	100	212

Temperature Scale	Water Boiling Point	Water Freezing Point	Conversion Formula
° F (Fahrenheit)	212° F	32° F	° F = (° C x 9/5) + 32
° C (Celsius or Centigrade)	100° C	0° C	° C = (° F - 32) x 5/9

**NOTE:** For temperatures not given in the table, use the conversion formula above.

# How to Reach Us

## Global Sales and Support

Questions? Need additional assistance?

Banner has more than 3,000 representatives and distributors worldwide — ready to help you.

Our highly skilled application engineers and industry experts are ready to support you wherever you are. For a complete listing, go to [bannerengineering.com](http://bannerengineering.com) and find your local Banner Representative.



To contact a Banner Engineer  
about your application, call

Technical Service  
1-888-3-SENSOR

1-888-3SENSOR (1-888-373-6767)

Contact Us Online

[www.bannerengineering.com/contact-us](http://www.bannerengineering.com/contact-us)



**Banner Engineering—Headquarters**

Phone: +1 763 544 3164  
[www.bannerengineering.com](http://www.bannerengineering.com)

**Banner Engineering—Europe**

Phone: +32 2 456 07 80  
[www.bannerengineering.com/eu](http://www.bannerengineering.com/eu)

**Banner Engineering—Mexico**

Phone: +52 81 8363-2714  
[www.bannerengineering.com.mx](http://www.bannerengineering.com.mx)

**Banner Engineering—China**

Phone: +86 21 33986888  
[www.bannerengineering.com.cn](http://www.bannerengineering.com.cn)

**Banner Engineering—India**

Phone: +91 20 66405623  
[www.bannerengineering.co.in](http://www.bannerengineering.co.in)

Model Family	Page
<b>A</b>	
AG4	693
Apertures	816
Area Lights	378
<b>B</b>	
Backlights	370
Brackets	722
<b>C</b>	
CL50	430
Cordsets	758
<b>D</b>	
D10	172
D12	216
DF-G1	168
DF-G2	166
<b>E</b>	
EA5R.. (EZ-ARRAY)	246
EDG1 Enabling Device	636
Emergency Stop Buttons	598
Enclosures	808
E-Stop & Stop Control	620
EZ-ARRAY	248
EZ-SCREEN Grid & Points	572
EZ-SCREEN LP	564
EZ-SCREEN LS	560
EZ-SCREEN Type 2	578
EZ-SCREEN Type 4	552

Model Family	Page
<b>F</b>	
Fiber Optics	162
Glass Fibers	192
Plastic Fibers	174
<b>H</b>	
High-Res MINI-ARRAY	256
<b>I</b>	
Illuminated E-Stops	598
Interlock Switches	640
iVu BCR	344
iVu TG	342
<b>K</b>	
K30 Push-Button (PICK-TO-LIGHT)	492
K30 Touch (PICK-TO-LIGHT)	486
K30 Touch Button	468
K30L (Indicator)	438
K30L Hazardous	446
K30L Push-Button (Touch Button)	468
K50 Optical	490
K50 Push-Button (PICK-TO-LIGHT)	492
K50 Touch (PICK-TO-LIGHT)	486
K50 Touch Button	472
K50BL	444
K50FL	461
K50L (Base Mount Indicator)	439
K50L Hazardous	446
K50L Push-Button (Touch Button)	472

Model Family	Page
K50LD	445
K80 Call Light	460
K80 Push-Button (PICK-TO-LIGHT)	492
K80 Segment	464
K80FL	462
K80L	458
K90	443
<b>L</b>	
Laser Line Generator Lights	377
LE	206
Lens Shields	812
LG	210
LH	208
Light Screens	552
Linear Array Backlights Lights	371
Linear Array Lights	372
Low-Angle Ring Lights	376
LT3	212
LT7	214
LTB	478
LTF	204
LX	148
<b>M</b>	
M12	116
M18 (Barrel Sensor)	126
M18-3	130
M1-4	206

Model Family	Page
M25U (Stainless Steel Sensor)	302
M25U (Ultrasonic Sensor)	226
MINI-ARRAY	252
MINI-BEAM (Rectangular Sensor)	68
MINI-BEAM (Clear Object Sensor)	322
MINI-BEAM (Hazardous Area)	330
Mirrors	806
OMNI-BEAM	320
<b>O</b>	
On-Axis Lights	373
OTB	478
<b>P</b>	
P4 BCR	354
P4 OMNI	354
PDV	496
PicoDot	92
Power Supplies	819
ProII	358
PVA	50
PVL	498
<b>Q</b>	
Q12	66
Q120R	245
Q20	70
Q25	78
Q26	318
Q3X	30

Model Family	Page
Q40	80
Q45 (Hazardous Area)	336
Q45 (Rectangular Sensor)	84
Q45U	232
Q45UR	234
Q4X	34
Q60	88
QC50	284
QCX50	284
QL56	288
QM26	298
QM42/QMT42	94
QMH26	300
QS18	40
QS18 DC	42
QS18 Expert	44
QS18 Laser	46
QS18 Adjustable-Field	48
QS18 Universal Voltage	50
QS18U	237
QS30	54
QS30 DC	56
QS30 Expert	59
QS30 Adjustable-Field	6
QS30 Universal Voltage	xxx
QS30 Clear Object	316
QT50R	244

Model Family	Page
QT50R-AF2W	244
QT50U	218
<b>R</b>	
R55F (Registration/Color Sensor)	294
R58	290
Reflectors	790
Ring Lights	366
Rope Pulls	622
Run Bars	690
<b>S</b>	
S12-2	118
S18	124
S18-2	122
S18L	450
S18U	222
S22L	451
S30	138
Safety Controllers	582
SC26-2	584
SC22-3	592
Safety Light Screens	552
Safety Modules	698
E-Stop Guard	699
Universal	706
Safety Mat Monitoring	708
Muting	710
Safe Speed	714

Model Family	Page
Interface Relay	716
Extension Relay	718
<b>SB12</b>	120
<b>SB12T</b>	120
<b>SC22-3</b>	592
<b>SC26-2</b>	584
<b>SL</b>	146
<b>SLM</b>	144
<b>SM30</b>	140
<b>SMI30</b>	338
<b>SM31.. (MINI-BEAM)</b>	76
<b>SMI30</b>	338
<b>SP150</b>	465
<b>SP250</b>	465
<b>SP350</b>	465
<b>Spot Lights</b>	374
<b>Stands</b>	802
<b>STB</b>	686
<b>T</b>	
<b>T18 (Right Angle Sensor)</b>	102
<b>T18U</b>	230
<b>T30 (Right Angle Sensor)</b>	110
<b>T30U</b>	226
<b>T30UX</b>	224
<b>T8</b>	100
<b>T8L</b>	454
<b>TCNM</b>	280
<b>T-GAGE</b>	260

Model Family	Page
<b>TL30F</b>	466
<b>TL50</b>	418
<b>TL50BL</b>	426
<b>TL70</b>	414
<b>TM18</b>	106
<b>Two-Hand Control</b>	680
<b>V</b>	
<b>VE</b>	350
<b>VS1</b>	156
<b>VS2</b>	158
<b>VS3</b>	160
<b>VSM (Miniature Sensor)</b>	154
<b>VSM (Stainless Steel Sensor)</b>	306
<b>VTB (Touch Button)</b>	480
<b>VTB (PICK-TO-LIGHT)</b>	494
<b>W</b>	
<b>WL50-2</b>	406
<b>WL50S</b>	406
<b>WLA</b>	402
<b>WLB32</b>	392
<b>WLB92</b>	394
<b>WLC60</b>	398
<b>WLC90</b>	400
<b>WLS27</b>	396
<b>WLS28-2</b>	386





# *Limited Warranty*

Banner Engineering Corp. warrants its products to be free from defects in material and workmanship for one year following the date of shipment. Banner Engineering Corp. will repair or replace, free of charge, any product of its manufacture which, at the time it is returned to the factory, is found to have been defective during the warranty period. This warranty does not cover damage or liability for misuse, abuse, or the improper application or installation of the Banner product.

**THIS LIMITED WARRANTY IS EXCLUSIVE AND IN LIEU OF ALL OTHER WARRANTIES WHETHER EXPRESS OR IMPLIED (INCLUDING, WITHOUT LIMITATION, ANY WARRANTY OF MERCHANTABILITY OR FITNESS FOR A PARTICULAR PURPOSE), AND WHETHER ARISING UNDER COURSE OF PERFORMANCE, COURSE OF DEALING OR TRADE USAGE.**

This Warranty is exclusive and limited to repair or, at the discretion of Banner Engineering Corp., replacement. **IN NO EVENT SHALL BANNER ENGINEERING CORP. BE LIABLE TO BUYER OR ANY OTHER PERSON OR ENTITY FOR ANY EXTRA COSTS, EXPENSES, LOSSES, LOSS OF PROFITS, OR ANY INCIDENTAL, CONSEQUENTIAL OR SPECIAL DAMAGES RESULTING FROM ANY PRODUCT DEFECT OR FROM THE USE OR INABILITY TO USE THE PRODUCT, WHETHER ARISING IN CONTRACT OR WARRANTY, STATUTE, TORT, STRICT LIABILITY, NEGLIGENCE, OR OTHERWISE.**



Banner Engineering Corp. reserves the right to change, modify or improve the design of the product without assuming any obligations or liabilities relating to any product previously manufactured by Banner Engineering Corp.